

COUPLE COFFEE TABLE — 84x120 CM

— Sylvain Willenz

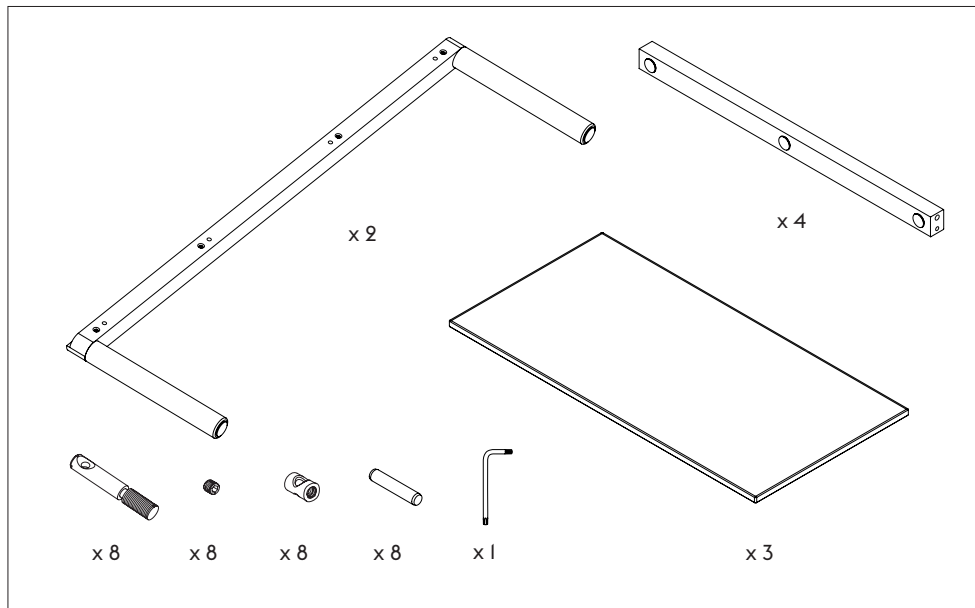

ASSEMBLY INSTRUCTION – SAMLEMANUAL – MONTAGEANLEITUNG
INSTRUCTIONS DE MONTAGE – INSTRUCCIONES DE MONTAJE

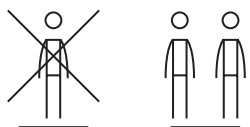

1

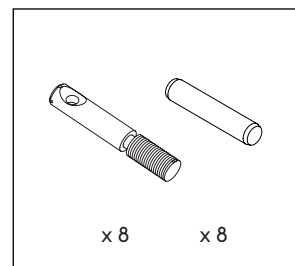
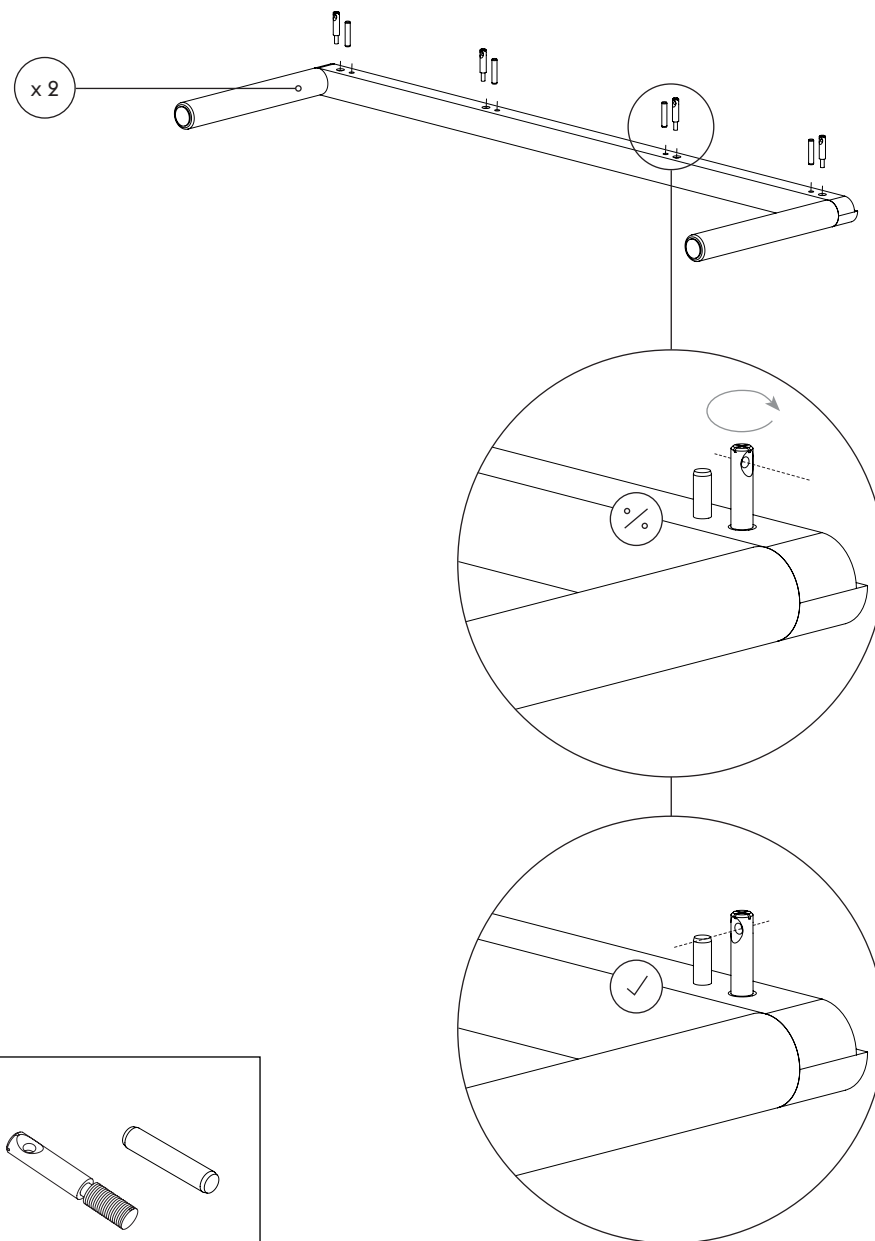

2

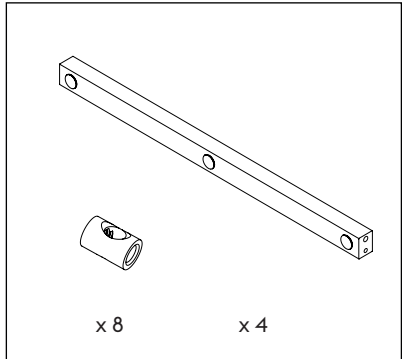
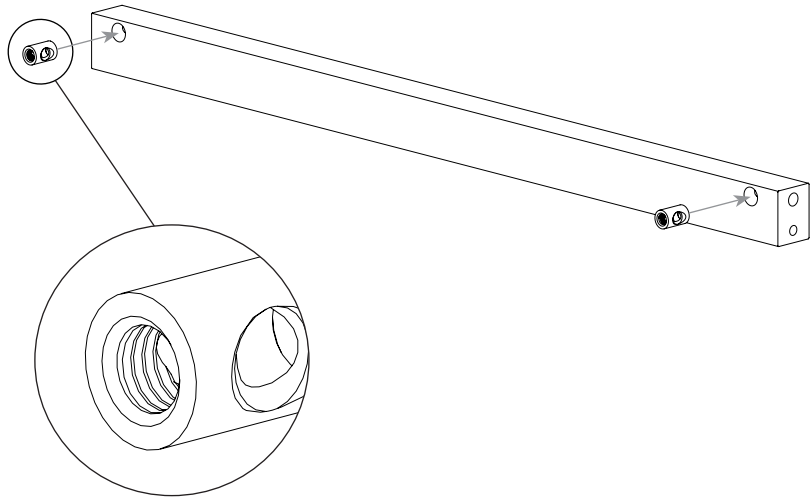

3

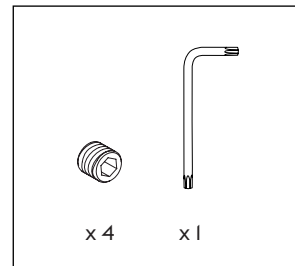
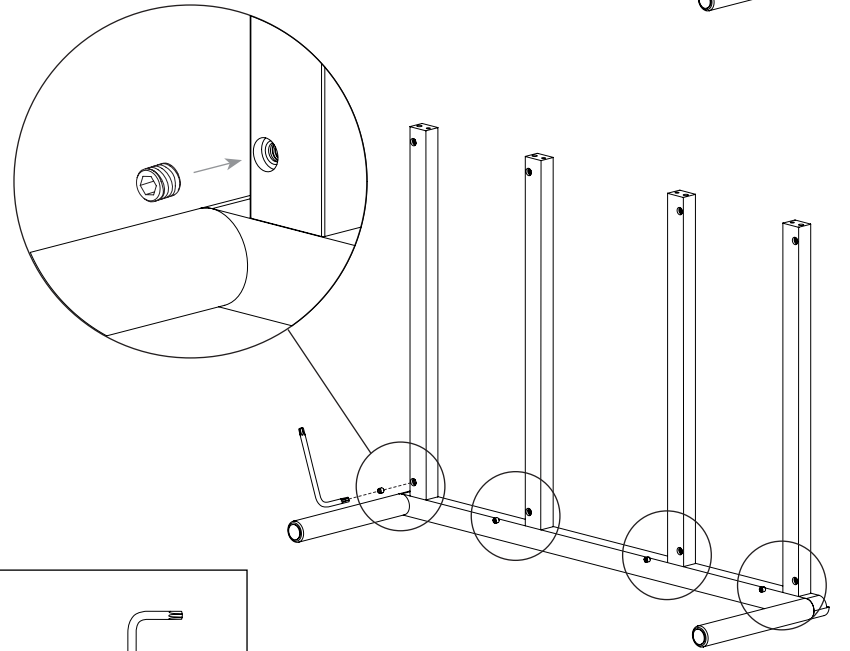
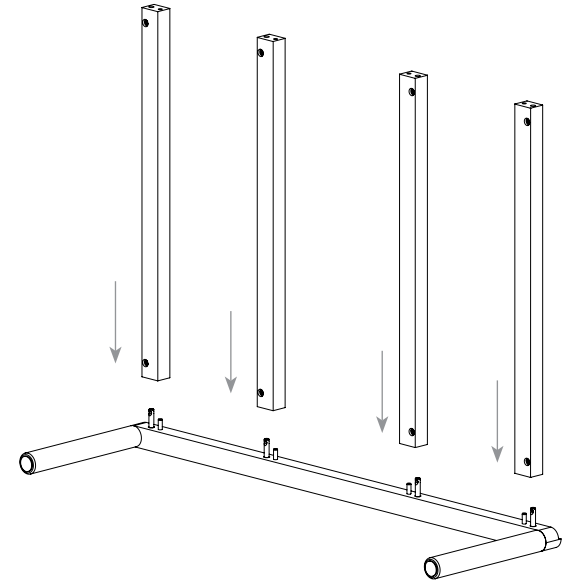

4

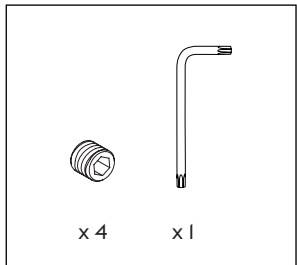
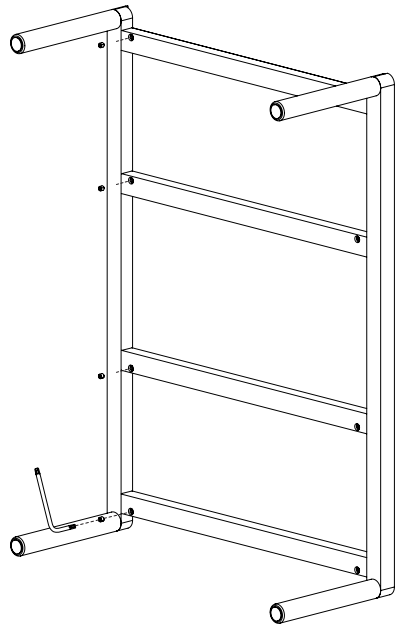
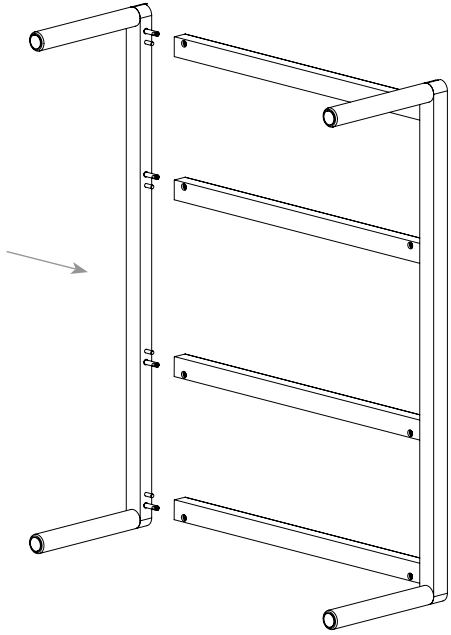

5

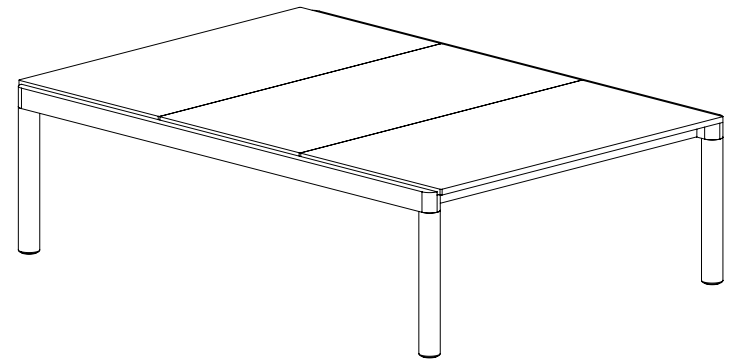
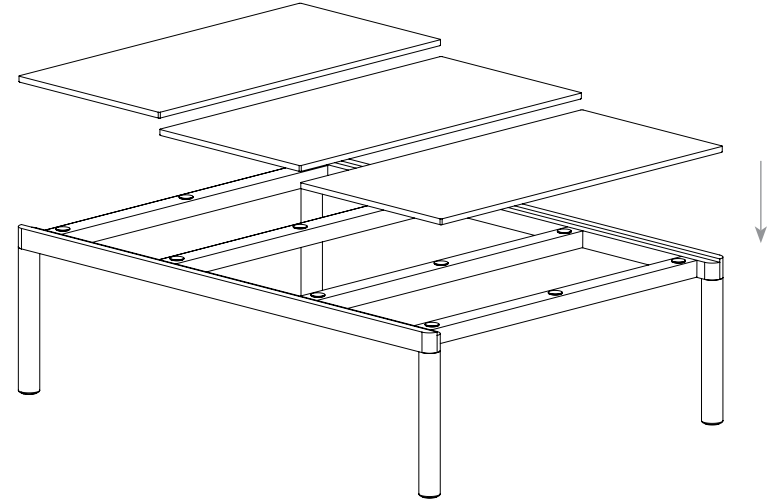
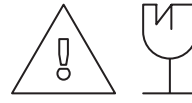

CLEANING — RENGØRING — SÄUBERN — NETTOYAGE — LIMPIEZA

- EN Clean with a damp cloth and a mild solution pH neutral cleaner and wipe dry to remove any residues. Never use strong chemicals. Water and grease may leave stains and should be removed right away.
- DK Rengør med en fugtig klud og et mildt pH neutralt rengøringsmiddel. Tør af for at fjerne eventuelle rester. Brug aldrig stærke kemikalier. Vand og fedt kan efterlade pletter og bør derfor fjernes med det samme.
- DE Mit einem feuchten Tuch und mildem ph-neutralen Reinigungsmittel reinigen. Abtrocknen, um Rückstände zu entfernen. Verwenden Sie niemals starke Chemikalien. Wasser und Fett muss umgehend entfernt werden.
- FR Nettoyer avec un chiffon humide et un nettoyant au pH neutre en solution douce et essuyer en séchant pour retirer tous les résidus. N'utilisez jamais de produits chimiques forts. L'eau et la graisse peuvent tacher et devraient être retiré tout de suite.
- ES Limpie con un paño húmedo y una solución suave de pH neutro y séquelo para eliminar cualquier residuo. Nunca use productos químicos agresivos. El agua y la grasa pueden dejar manchas y se deben retirarse de inmediato.