

CONTRACT PRICE LIST

JULY

2024



**On this page, you will find important product and order information.
Please contact your Muuto Sales Manager if you need further information.**

Prices

All prices exclude Sales Tax.

Prices are valid from 07.01.2024

All prices are subject to change and printer's errors.

Warranty

According to Muuto's general terms of sale and delivery:

10 years on all BIFMA-certified products.

5 years for all other products.

Discontinued Products

Products marked with *** will be discontinued when out of stock.

Lead Times

General minimum lead times for when products ship are:

- QuickShip/Ready-To-Ship - US Warehouse: 3-4 weeks

- Ready-To-Ship - EU Warehouse: 6-8 weeks

- Made-To-Order: 8-16 weeks

Please use the lead time overview on Dealer Portal or reach out to your Muuto Sales Representative for current lead times per product.

Customer's Own Material

For Customer's Own Material (COM), Customer's Imitation Leather (CIL) and Customers Own Leather (COL), please note that the cost of the material is not necessarily included in the price and requests are subject to testing and approval. Please follow the guideline below to find out how to quote a Muuto

COM/CIL/COL Guide:

1. Use the Muuto COM Tool on professionals.muuto.com to check if the material has been tested for a specific product.
2. If the material is approved for the specific product, click on the Note section on the right-hand side of the page. Below "Can the supplier source the fabric" it will say either "Yes" or "No":
 - "Yes" means it will follow a hybrid COM process and Muuto will be able to procure and ship the fabric on the dealer/retailer's behalf and include international shipping, duties, and any other applicable fees into the price.
 - "No" means it will follow the standard COM process and the dealer/retailer is to procure and ship the fabric themselves.

Please reach out to muutoCOM@millerknoll.com for a quote for any hybrid COM or for more information.

3. If the material is not listed, it has not been tested for the specific product. Email muutoCOM@millerknoll.com for details on how to test the material.

Ready-To-Ship

Ready-To-Ship - US Warehouse: Products that are a part of our US warehouse assortment.

Ready-To-Ship - EU Warehouse: Products that are a part of our EU warehouse assortment and can be shipped from Europe.

Colli

Colli indicates the number of items per item number.

Shipper Colli

Shipper Colli indicates the number of boxes an item will be shipped in.

Test, Labels & Certificates

For a full overview of our tests and certificates, visit

www.professionals.muuto.com/test-certificates/

Please confirm conformance to the attributes of a specific test at the time of specifying your order as information is subject to change.

Contact Information

www.muuto.com/contact

Explore our new perspectives on Scandinavian design across furniture, lighting and accessories. Each design within our collection has its own family page with designer quote, product description, material information, cleaning instructions and more, followed by the pricing options for each individual variant.

INTRODUCTION TO THE PRICE LIST _____	1		
INDEX _____	2		
FURNITURE			
70/70 Table _____	5		
70/70 Table _____	7		
Made-To-Order Options _____	15		
70/70 Outdoor _____	16		
Airy Coffee Table _____	19		
Around Coffee Table _____	24		
Base Table Series _____	28		
Base Table _____	29		
Base Round Table _____	32		
Base High Table _____	33		
Made-To-Order Options _____	37		
Cable Management _____	41		
Compile Shelving System _____	43		
Compile Shelving System Configurations _____			
Compile Shelving System Shelf _____	52	44	
Compile Shelving System Essential Pack _____			
Compile Shelving System Divider Pack _____	53		
Connect Modular Sofa _____	55	54	
Connect Modular Sofa _____	59		
Made-To-Order Options _____	66		
Connect Soft Modular Sofa _____	67		
Connect Soft Modular Sofa Modules _____	71		
Connect Soft Modular Sofa 2-Seater Configurations _____	80		
Connect Soft Modular Sofa 3-Seater Configurations _____	83		
Connect Soft Modular Sofa Corner Configurations _____	86		
Connect Soft Modular Sofa Cushion _____	89		
Made-To-Order Options _____	90		
Couple Coffee Table _____	91		
Cover Chair Series _____	95		
Cover Armchair _____	98		
Cover Lounge Chair _____	99		
Cover Side Chair _____	100		
Cover and Visu Chair Transport Trolley _____			
Cover Counter Stool 65 cm / 25.6" _____	102	101	
Cover Bar Stool 75 cm / 29.5" _____	103		
Made-To-Order Options _____	104		
Doze Lounge Chair & Ottoman _____	106		
Doze Lounge Chair High Back Tube Base _____	108		
Doze Lounge Chair High Back Swivel Base _____	109		
Doze Ottoman Tube Base _____	110		
Doze Ottoman Swivel Base _____	111		
Made-To-Order Options _____	112		
Echo Pouf _____	113		
Echo Pouf _____	114		
Made-To-Order Options _____	117		
Enfold Sideboard _____	118		
Fiber Chair Series _____	123		
Fiber Armchair Tube Base _____	126		
Fiber Armchair Swivel Base _____	127		
Fiber Armchair Wood Base _____	128		
Fiber Armchair Swivel Base w. Gas Lift and Castors _____	129		
Fiber Side Chair Tube Base _____	130		
Fiber Side Chair Swivel Base _____	131		
Fiber Side Chair A-Base _____	132		
Fiber Side Chair Wood Base _____	133		
Fiber Lounge Chair Wood Base _____	134		
Fiber Lounge Chair Tube Base _____	135		
Fiber Counter Stool Wood Base - 65 cm / 25.6" _____	136		
Fiber Counter Stool Tube Base - 65 cm / 25.6" _____	138		
Fiber Bar Stool Wood Base - 75 cm / 29.5" _____	140		
Fiber Bar Stool Tube Base - 75 cm / 29.5" _____	142		
Fiber Lounge Chair Seat Pad _____	144	142	
Fiber Chair Seat Pad _____	145		
Made-To-Order: Fiber Armchair wood, tube, sled base _____	146		
Made-To-Order: Fiber Armchair Swivel, Swivel w/castors & Gaslift _____	147		
Made-To-Order: Fiber Side Chair wood, tube, sled base _____	148		
Made-To-Order: Fiber Side Chair Swivel, Swivel w/castors & Gaslift _____	149		
Made-To-Order: Fiber Side Chair A-base _____			
Made-To-Order: Fiber Stools _____	151	150	
Made-To-Order: Fiber Lounge _____	153		
Fiber Soft Series _____	154		
Fiber Soft Armchair Wood Base _____	156		
Fiber Soft Armchair Tube Base _____	157		
Fiber Soft Armchair Swivel Base _____	158		
Made-To-Order Options: Fiber Soft Armchair _____	159		
Fiber Conference Armchair _____	162		
Fiber Conference Armchair Wood Base _____			
Fiber Conference Armchair Swivel Base _____	164		
Fiber Conference Armchair Swivel Base w. Gas Lift, Castors and Tilt _____	166		
Made-To-Order Options _____	167		
Fiber Outdoor Series _____	170		
Fiber Outdoor Armchair _____	172		
Fiber Outdoor Side Chair _____	173		
Five Pouf _____	174		
Five Pouf _____	175		
Made-To-Order Options _____	177		
Flow Trolley _____	178		
Halves Side Table _____	181		
In Situ Modular Sofa _____	183		
In Situ Modular Sofa 2-Seater Configurations _____	187		
In Situ Modular Sofa 3-Seater Configurations _____	194		
In Situ Modular Sofa 4-Seater Configurations _____	203		
In Situ Modular Sofa Corner Configurations _____	208		
In Situ Modular Sofa Modules _____	217		
In Situ Modular Sofa Cushion _____	226		
In Situ Modular Sofa Frame Section _____	228		
In Situ Modular Sofa Linking Bracket _____	238		
In Situ Modular Sofa Frame Configuration _____	239		
Made-To-Order Options - Individual parts _____	243		
Linear System Series _____	244		
Linear System Middle Module _____	258		
Linear System Table _____	259		
Linear System End Module _____	262		
Linear System Connecting Legs _____	264		
Linear System Configurations _____	265		
Linear System Tray _____	268		
Linear System Screen _____	271		
Linear System Power Configuration _____	274		
Linear System Cable Tray _____	275		
Linear System Table Power Outlet _____	276		
Made-To-Order Options: Linear System Screens _____	277		
Linear Steel Series _____	278		
Linear Steel Table _____	280		

Linear Steel Bench	283	Soft Café Table	399	Tip Table Lamp	526
Linear Steel Armchair	285	Stacked Storage System	405	Tip Wall Lamp	527
Linear Steel Side Chair	286	Stacked Storage System Open Modules		Under The Bell Pendant Lamp	528
Linear Steel Café Table	287	Stacked Storage System Modules w.	407	Unfold Pendant Lamp	532
Linear Steel Bar Stool 75 cm / 29.5"	293	Backboard	410		
Linear Steel Counter Stool 65 cm / 25.6"		Stacked Storage System Modules w.			
Linear Steel Lounge Armchair	295/294	Door	413		
Linear Steel Coffee Table	296	Stacked Storage System Clips	414		
Linear Steel Set Pads	298	Stacked Storage System Acoustic Panel		ACCESSORIES	
Linear Steel Chair/Lounge Chair Seat				Ample Throw	537
Pad	300	Still Café Table	418/415	Arced Mirror	539
Linear Steel Bench Seat Pad	301	Visu Chair Series	428	Attach Coat Hook	542
Linear Wood Series	303	Visu Chair Wood Base	430	Avail Coat Rack	544
Linear Wood Table	304	Visu Chair Tube Base	431	Coil Coat Rack	546
Linear Wood Bench	307	Visu Chair Sled Base	432	Compile Bookend	549
Loft Chair Series	309	Cover and Visu Chair Transport Trolley		Corky Series	551
Loft Chair	311	Visu Lounge Chair Wood Base	434/433	Corky Glasses Set of 4	552
Loft Chair W. Armrest	312	Visu Counter Stool Wood Base - 65 cm / 25.6"	435	Corky Carafe	553
Loft Counter Stool 65 cm / 25.6"	313	Visu Bar Stool Wood Base - 75 cm / 29.5"		Dots Series	554
Loft Bar Stool 75 cm / 29.5"	314	Made-To-Order Options	437/436	Dots Wood	555
Made-To-Order Options	315	Workshop Series	441	Dots Metal	563
Midst Table	316	Workshop Chair	443	Dots Ceramic	567
Mini Stacked Storage System	320	Workshop Bench	444	Folded Shelves	569
Nerd Chair Series	325	Workshop Table	445	Framed Mirror	575
Nerd Chair	326	Workshop Coffee Table	448	Groove Trivet	578
Nerd Counter Stool 65 cm / 25.6"	327	Wrap Lounge Chair	450	Kink Vase	580
Nerd Bar stool 75 cm / 29.5"	329	Wrap Lounge Chair	451	Layer Cushion	582
Oslo Series	331	Made-To-Order Options: Wrap Lounge		Mere Bowl	585
Oslo Counter Stool 65 cm / 25.6"	333	Chair	452	Mingle Cushion	588
Oslo Bar Stool 75 cm / 29.5"	334			Pebble Rug	591
Oslo Lounge Chair Tube Base	335	LIGHTING		Platform Tray	594
Oslo Lounge Chair Swivel Base	336	Ambit Lamp Series	454	Ply Rug	596
Oslo Sofa 2-Seater	337	Ambit Rail Lamp	456	Raise Series	603
Oslo Sofa 3-Seater	338	Ambit Wall Lamp	457	Raise Carafe	604
Made-To-Order Options	339	Ambit Pendant Lamp	458	Raise Glasses Set of 2	605
Made-To-Order Options: Oslo Lounge		Beam Table Lamp	462	Reduce Paper Bin	606
Outline Sofa Series	342/341	Control Table Lamp	465	Relevo Rug	608
Outline Sofa 2-Seater	347	Dedicate Lamp Series	467	Restore Series	611
Outline Sofa 3-Seater	349	Dedicate Table Lamp	469	Restore Basket	612
Outline Chair	351	Dedicate Wall Lamp	478	Restore Tray	613
Outline Daybed	353	E27 Pendant Lamp	481	Restore Round Basket	614
Outline Daybed Cushion	354	Fluid Pendant Lamp	485	Rhythm Throw	615
Outline Highback Work 100 l-Seater	355	Grain Pendant Lamp	489	Ridge Vase	617
Outline Highback Sofa 100 l-Seater	359	Leaf Lamp Series	492	Silent Vase	621
Outline Highback Sofa 100 2-Seater	361	Leaf Table Lamp	493	Story Pinboard	625
Made-To-Order Options: Outline Series		Leaf Floor Lamp	494	Tub Jug	627
Made-To-Order Options: Outline	363	Linear Lamp Series	495	Twine Cushion	629
Studio Series	365	Linear Table Lamp	497	Varjo Rug	631
Made-To-Order Options: Outline		Linear Mounted Lamp	498	Wave Tray	634
Highback Series	367	Linear Pendant Lamp	500	COLOR CODE INDEX	636
Power Outlet	373	Post Lamp Series	502	UPHOLSTERY OVERVIEW	648
Reflect Sidebord	375	Post Floor Lamp	504		
Relate Side Table	378	Post Wall Lamp	505		
Rest Sofa Series	382	Pull Floor Lamp	506		
Rest Sofa 3-Seater	383	Rime Lamp Series	508		
Made-To-Order Options	384	Set Table Lamp	513		
Soft Table Series	385	Strand Lamp Series	515		
Soft Side Table	387	Strand Pendant Lamp	517		
Soft Coffee Table	393	Strand Table Lamp	523		
Soft Table	396	Tip Lamp Series	524		

FURNITURE

70/70 TABLE

"The 70/70 Table is a study in geometric forms, identifying the dimensions that make a balanced design. With its simple and understated expression, the 70/70 Table finds its unique form through careful detailing. Here, the slanted plywood edges of the slender table top and edged triangular shapes of its frame make the 70/70 Table a testament to the ideals of Scandinavian design."

— TAF Studio



Designed by	TAF Studio
Environment	Indoor
Country of Production	Tabletop: Denmark Table frame: China
Assembly Required	Yes
Description	The 70/70 Table is designed with a simple expression, paired with subtle, understated details that reveal themselves upon closer inspection. Adding character to the design, the details of the 70/70 Table include the triangular shape of its base for a modern expression and the slanted edges of the table top. Available in a variety of sizes and finishes, the 70/70 Table is an ideal match for any dining area, home office, workplace or hospitality area.
Material	Tabletop in plywood with lacquered oak veneer surface, Black and Grey version in plywood with linoleum surface, White and Sand version in plywood with laminate surface (HPL). Solid Oak and Solid Smoked Oak tabletop in FSC™-certified (FSC-CO28824) oak. Frame in powder coated aluminum.
Cleaning & Care	<p>Laminate & Linoleum: Clean the table with a damp cloth. If necessary, only use a mild detergent or washing up liquid and not concentrated. Always wipe with a dry cloth afterwards. To minimize the risk of stains and marks, liquid, grease etc. should be removed straight away. For linoleum versions, linoleum care is recommended for optimum saturation of the natural material 2-3 times a year. It is recommended to clean linoleum versions with a damp cloth and a pH neutral cleaner and wipe dry to remove any residues.</p> <p>Solid Oak & Solid Smoked Oak: Upon receiving your table, we recommend that table top and bottom is treated with a special oak wood oil, improving its resistance to stains and fluids. We also recommend that you continue caring for the product by repeating this treatment 2-3 times a year. For products in Solid Oak, we recommend using a tabletop oil with a small amount of white pigment, suitable for food applications*. For products in Smoked Oak, we recommend using a smoked tabletop oil, suitable for food applications*.</p> <p>Avoid placing the table in the immediate distance of a heat source. Do not place hot or wet objects directly on the table, as they can leave a mark on the table top. Metal objects can leave a mark if left on the table for a longer period of time.</p> <p>Any spill should immediately be removed to avoid discoloring. Clean the table top often and carefully with a soft and dry cloth following the wood's grain patterns.</p> <p>*Muuto recommends that you contact your local hardware store to get advice on oils for indoor use.</p> <p>Oak Veneer: Clean the table with a damp cloth. If necessary, only use a mild detergent or washing up liquid and not concentrated. Always wipe with a dry cloth afterwards. To minimize the risk of stains and marks, liquid, grease etc. should be removed straight away.</p>

Made-to-Order

Non-standard size tables are made to order with maximum width of 110 cm / 43.3" minimum width of 80 cm / 31.5", max. length of 295 cm / 116.1" and min. length of 140 cm / 55.1".

EN 15372:2016 - L3

TESTS & CERTIFICATIONS

Extreme use. Furniture – Strength, durability and safety. Requirements for non-domestic tables.

ANSI/BIFMA X5.5-2014

American National Standard for Office. Furnishings - Desk Products.

VOC CDPH 01350 & VOC BIFMA X7.1.

The 70/70 Table in Solid and Smoked Oak is tested to VOC CDPH 01350 and VOC BIFMA X7.1. Standard Test Method for Determining VOC Emissions from Office Furniture Systems, Components and Seating. Veneer versions of the 70/70 Table is also VOC BIFMA X7.1 tested.

Forest Stewardship Council™

Tabletop in Solid Oak and Smoked Oak is made from FSC™-certified (FSC-CO28824) wood.

70/70 TABLE / 170 X 85 CM / 67 X 33.5"

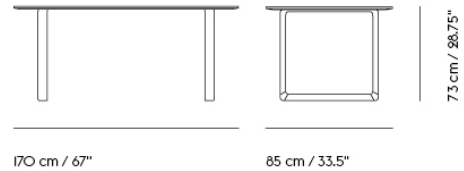

Shipper Colli	2
Gross Weight (kg)	46.31
Net Weight (kg)	39.6
Base color options	Black, Grey, Sand or White
Warranty Period	10 years

Pattern No.	Color	Contract Price	Lead Time
Ready-To-Ship US Warehouse			
M7070T6734L-BLCK-WHIT	White Laminate/Plywood/Black	USD 2,256.00	-
M7070T6734L-GREY-WHIT	White Laminate/Plywood/Grey	USD 2,256.00	-
M7070T6734L-SAND-WHIT	White Laminate/Plywood/Sand	USD 2,256.00	-
M7070T6734L-WHIT-WHIT	White Laminate/Plywood/White	USD 2,256.00	-
M7070T6734V-BLCK-OAK	Oak Veneer/Plywood/Black	USD 2,571.00	-
M7070T6734V-GREY-OAK	Oak Veneer/Plywood/Grey	USD 2,571.00	-
M7070T6734V-SAND-OAK	Oak Veneer/Plywood/Sand	USD 2,571.00	-
M7070T6734V-WHIT-OAK	Oak Veneer/Plywood/White	USD 2,571.00	-
M7070T6734O-BLCK-BLCK	Black Linoleum/Plywood/Black	USD 2,256.00	-
M7070T6734O-GREY-BLCK	Black Linoleum/Plywood/Grey	USD 2,256.00	-
M7070T6734O-SAND-BLCK	Black Linoleum/Plywood/Sand	USD 2,256.00	-
M7070T6734O-WHIT-BLCK	Black Linoleum/Plywood/White	USD 2,256.00	-
M7070T6734O-SAND-GREY	Grey Linoleum/Plywood/Sand	USD 2,256.00	-
M7070T6734W-BLCK-SOAK	Solid Oak/Black	USD 3,306.00	-
M7070T6734W-GREY-SOAK	Solid Oak/Grey	USD 3,306.00	-
M7070T6734W-SAND-SOAK	Solid Oak/Sand	USD 3,306.00	-
M7070T6734W-BLCK-SMOAK	Solid Smoked Oak/Black	USD 3,516.00	-
M7070T6734W-GREY-SMOAK	Solid Smoked Oak/Grey	USD 3,516.00	-

Pattern No.	Color	Contract Price	Lead Time
M7070T6734W-SAND-SMOAK	Solid Smoked Oak/Sand	USD 3,516.00	-
M7070T6734W-WHIT-SMOAK	Solid Smoked Oak/White	USD 3,516.00	-

**Ready-To-Ship EU
Warehouse**

M7070T6734O-BLCK-GREY	Grey Linoleum/Plywood/Black	USD 2,256.00	-
M7070T6734O-GREY-GREY	Grey Linoleum/Plywood/Grey	USD 2,256.00	-
M7070T6734O-WHIT-GREY	Grey Linoleum/Plywood/White	USD 2,256.00	-
M7070T6734W-WHIT-SOAK	Solid Oak/White	USD 3,306.00	-

70/70 TABLE / 225 X 90 CM / 88.5 X 35.5"

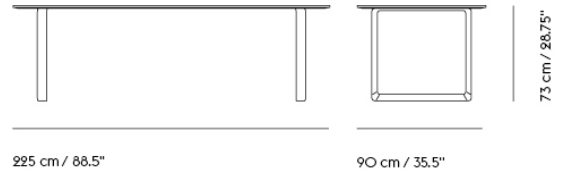

Shipper Colli	2
Gross Weight (kg)	78.8l
Net Weight (kg)	72.l
Base color options	Black, Grey, Sand or White
Warranty Period	10 years

Pattern No.	Color	Contract Price	Lead Time
Ready-To-Ship US Warehouse			
M7070T8936L-BLCK-WHIT	White Laminate/Plywood/Black	USD 3,040.00	-
M7070T8936L-GREY-WHIT	White Laminate/Plywood/Grey	USD 3,040.00	-
M7070T8936L-SAND-WHIT	White Laminate/Plywood/Sand	USD 3,040.00	-
M7070T8936L-WHIT-WHIT	White Laminate/Plywood/White	USD 3,040.00	-
M7070T8936V-BLCK-OAK	Oak Veneer/Plywood/Black	USD 3,306.00	-
M7070T8936V-GREY-OAK	Oak Veneer/Plywood/Grey	USD 3,306.00	-
M7070T8936V-SAND-OAK	Oak Veneer/Plywood/Sand	USD 3,306.00	-
M7070T8936V-WHIT-OAK	Oak Veneer/Plywood/White	USD 3,306.00	-
M7070T8936O-BLCK-BLCK	Black Linoleum/Plywood/Black	USD 3,040.00	-
M7070T8936O-GREY-BLCK	Black Linoleum/Plywood/Grey	USD 3,040.00	-
M7070T8936O-SAND-BLCK	Black Linoleum/Plywood/Sand	USD 3,040.00	-
M7070T8936O-WHIT-BLCK	Black Linoleum/Plywood/White	USD 3,040.00	-
M7070T8936O-SAND-GREY	Grey Linoleum/Plywood/Sand	USD 3,040.00	-
M7070T8936W-BLCK-SOAK	Solid Oak/Black	USD 4,566.00	-
M7070T8936W-GREY-SOAK	Solid Oak/Grey	USD 4,566.00	-
M7070T8936W-SAND-SOAK	Solid Oak/Sand	USD 4,566.00	-
M7070T8936W-WHIT-SOAK	Solid Oak/White	USD 4,566.00	-
M7070T8936W-BLCK-SMOAK	Solid Smoked Oak/Black	USD 4,671.00	-
M7070T8936W-GREY-SMOAK	Solid Smoked Oak/Grey	USD 4,671.00	-

Pattern No.	Color	Contract Price	Lead Time
M7070T8936W-SAND-SMOAK	Solid Smoked Oak/Sand	USD 4,671.00	-
M7070T8936W-WHIT-SMOAK	Solid Smoked Oak/White	USD 4,671.00	-

**Ready-To-Ship EU
Warehouse**

M7070T8936O-BLCK-GREY	Grey Linoleum/Plywood/Black	USD 3,040.00	-
M7070T8936O-GREY-GREY	Grey Linoleum/Plywood/Grey	USD 3,040.00	-
M7070T8936O-WHIT-GREY	Grey Linoleum/Plywood/White	USD 3,040.00	-

70/70 TABLE / 255 X 108 CM / 100.5 X 42.5"



255 cm / 100.5"

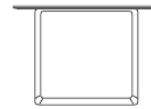

73 cm / 28.75"

108 cm / 42.5"

Shipper Colli	2
Gross Weight (kg)	100.85
Net Weight (kg)	92
Base color options	Black, Grey, Sand or White
Warranty Period	10 years

Pattern No.	Color	Contract Price	Lead Time
Ready-To-Ship US Warehouse			
M7070T10143L-BLCK-WHIT	White Laminate/Plywood/Black	USD 3,145.00	-
M7070T10143L-GREY-WHIT	White Laminate/Plywood/Grey	USD 3,145.00	-
M7070T10143L-SAND-WHIT	White Laminate/Plywood/Sand	USD 3,145.00	-
M7070T10143L-WHIT-WHIT	White Laminate/Plywood/White	USD 3,145.00	-
M7070T10143V-BLCK-OAK	Oak Veneer/Plywood/Black	USD 3,621.00	-
M7070T10143V-GREY-OAK	Oak Veneer/Plywood/Grey	USD 3,621.00	-
M7070T10143V-SAND-OAK	Oak Veneer/Plywood/Sand	USD 3,621.00	-
M7070T10143V-WHIT-OAK	Oak Veneer/Plywood/White	USD 3,621.00	-
M7070T10143O-BLCK-BLCK	Black Linoleum/Plywood/Black	USD 3,145.00	-
M7070T10143O-GREY-BLCK	Black Linoleum/Plywood/Grey	USD 3,145.00	-
M7070T10143O-SAND-BLCK	Black Linoleum/Plywood/Sand	USD 3,145.00	-
M7070T10143O-WHIT-BLCK	Black Linoleum/Plywood/White	USD 3,145.00	-
M7070T10143W-BLCK-SOAK	Solid Oak/Black	USD 5,770.00	-
M7070T10143W-GREY-SOAK	Solid Oak/Grey	USD 5,770.00	-
M7070T10143W-SAND-SOAK	Solid Oak/Sand	USD 5,770.00	-
M7070T10143W-WHIT-SOAK	Solid Oak/White	USD 5,770.00	-

Pattern No.	Color	Contract Price	Lead Time
M7070T10143W-BLCK-SMOAK	Solid Smoked Oak/Black	USD 6,141.00	-
M7070T10143W-GREY-SMOAK	Solid Smoked Oak/Grey	USD 6,141.00	-
M7070T10143W-SAND-SMOAK	Solid Smoked Oak/Sand	USD 6,141.00	-
M7070T10143W-WHIT-SMOAK	Solid Smoked Oak/White	USD 6,141.00	-

Ready-To-Ship EU Warehouse

M7070T10143O-BLCK-GREY	Grey Linoleum/Plywood/Black	USD 3,145.00	-
M7070T10143O-GREY-GREY	Grey Linoleum/Plywood/Grey	USD 3,145.00	-
M7070T10143O-SAND-GREY	Grey Linoleum/Plywood/Sand	USD 3,145.00	-
M7070T10143O-WHIT-GREY	Grey Linoleum/Plywood/White	USD 3,145.00	-

70/70 TABLE / 295 X 108 CM / 116 X 42.5"

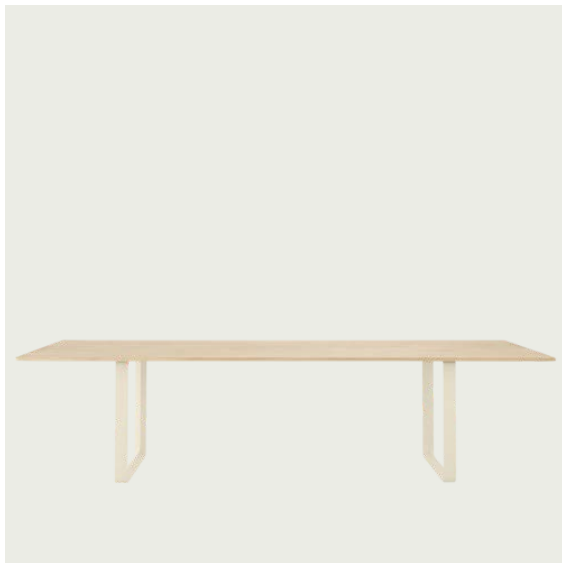

295 cm / 116.1"

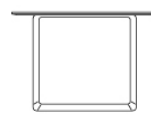

73 cm / 28.75"

108 cm / 42.5"

Shipper Colli	2
Gross Weight (kg)	111.65
Net Weight (kg)	102.8
Base color options	Black, Grey, Sand or White
Warranty Period	10 years

Pattern No.	Color	Contract Price	Lead Time
Ready-To-Ship US Warehouse			
M7070T11643L-BLCK-WHIT	White Laminate/Plywood/Black	USD 3,355.00	-
M7070T11643L-GREY-WHIT	White Laminate/Plywood/Grey	USD 3,355.00	-
M7070T11643L-WHIT-WHIT	White Laminate/Plywood/White	USD 3,355.00	-
M7070T11643V-BLCK-OAK	Oak Veneer/Plywood/Black	USD 3,880.00	-
M7070T11643V-GREY-OAK	Oak Veneer/Plywood/Grey	USD 3,880.00	-
M7070T11643V-SAND-OAK	Oak Veneer/Plywood/Sand	USD 3,880.00	-
M7070T11643V-WHIT-OAK	Oak Veneer/Plywood/White	USD 3,880.00	-
M7070T11643O-BLCK-BLCK	Black Linoleum/Plywood/Black	USD 3,355.00	-
M7070T11643O-GREY-BLCK	Black Linoleum/Plywood/Grey	USD 3,355.00	-
M7070T11643O-SAND-BLCK	Black Linoleum/Plywood/Sand	USD 3,355.00	-
M7070T11643O-WHIT-BLCK	Black Linoleum/Plywood/White	USD 3,355.00	-
M7070T11643W-BLCK-SOAK	Solid Oak/Black	USD 6,351.00	-
M7070T11643W-GREY-SOAK	Solid Oak/Grey	USD 6,351.00	-
M7070T11643W-SAND-SOAK	Solid Oak/Sand	USD 6,351.00	-
M7070T11643W-WHIT-SOAK	Solid Oak/White	USD 6,351.00	-
M7070T11643W-BLCK-SMOAK	Solid Smoked Oak/Black	USD 6,715.00	-

Pattern No.	Color	Contract Price	Lead Time
M7070T11643W-GREY-SMOAK	Solid Smoked Oak/Grey	USD 6,715.00	-
M7070T11643W-SAND-SMOAK	Solid Smoked Oak/Sand	USD 6,715.00	-
M7070T11643W-WHIT-SMOAK	Solid Smoked Oak/White	USD 6,715.00	-

Ready-To-Ship EU Warehouse

M7070T11643L-SAND-WHIT	White Laminate/Plywood/Sand	USD 3,355.00	-
M7070T11643O-BLCK-GREY	Grey Linoleum/Plywood/Black	USD 3,355.00	-
M7070T11643O-GREY-GREY	Grey Linoleum/Plywood/Grey	USD 3,355.00	-
M7070T11643O-SAND-GREY	Grey Linoleum/Plywood/Sand	USD 3,355.00	-
M7070T11643O-WHIT-GREY	Grey Linoleum/Plywood/White	USD 3,355.00	-



All Variants

Sizes	Pattern No.	Width	Depth	Height	Contract Price					
					Laminate (L)	Linoleum (O)	Oak veneer (V)	Nanolaminate (N)	Solid Oak (W)	Solid Smoked Oak (W)
70/70 Table / 170 X 85 CM / 67 X 33.5"	M-7070T-6734-	67"	34"	28.75"	2,256	2,256	2,571	2,571	3,306	3,516
70/70 Table / 225 X 90 CM / 88.5 X 35.5"	M-7070T-8936-	88.5"	35.5"	28.75"	3,040	3,040	3,306	3,355	4,566	4,671
70/70 Table / 255 X 108 CM / 100.5 X 42.5"	M-7070T-10143-	100.5"	42.5"	28.75"	3,145	3,145	3,621	3,565	5,770	6,141
70/70 Table / 295 X 108 CM / 116 X 42.5"	M-7070T-11643-	116"	42.5"	28.75"	3,355	3,355	3,880	3,831	6,351	6,715

HOW TO CONFIGURE

Specify:

- Step 1) Select Size
- Step 2) Select table top material
- Step 3) Select Base color
- Step 4) Select Table top color

ORDER CODE EXAMPLE

70/70 Table 100.5 x 42.5" with oak veneer table top and black base

Size	255 X 108 CM / 100.5 X 42.5"	M-7070T-10143-
Table top material	Veneer	V
Base color	Black base	BLCK
Table top finish	Oak veneer	OAK
Final Pattern No.	M7070T10143VBLCKOAK	

Table Top Material	Base Color Options	Table Top Finish
L - Laminate O - Linoleum V - Veneer N - Nanolaminate W - Solid Wood	WHIT - White BLCK - Black GREY - Grey SAND - Sand	Laminate WHIT - White Linoleum BLCK - Black GREY - Grey Veneer OAK - Oak Nanolaminate WHIT - White BLCK - Black GREY - Grey Solid Wood SOAK - W1 Solid Oak SMOAK - W2 Solid Smoked Oak

70/70 OUTDOOR TABLE

"The 70/70 Outdoor Table is a study in geometric forms, identifying the dimensions that make a balanced design. With its simple and subtle expression, the design finds its unique form through careful detailing. The 70/70 Outdoor Table features a slender tabletop alongside the unique triangular shape of its frame, bringing an understatedly modern perspective to life outdoors."

— TAF Studio



Designed by	TAF Studio
Environment	Outdoor
Country of Production	Tabletop: Denmark Table frame: China
Assembly Required	Yes
Description	The 70/70 Outdoor Table is designed with a simple expression, paired with subtle, understated details that reveal themselves upon closer inspection. Available with FSC-certified Sapele Mahogany, a durable hardwood resistant to the wear and tear of being outdoors. With time, the wood will lose some of its reddish glow, giving way to a grey-tone patina. Treat with wood oil to enhance some of the natural red of the wood.
Material	Tabletop in FSC™-certified (FSC-CO28824) Sapele Mahogany, a durable hardwood suitable for outdoor use. Initially, the Sapele Mahogany tabletop will have a warm glow. If left as is, untreated, the wood will patinate over time and turn a silver shade of grey. Treat the wood with oil for a deeper warm glow and a more reddish expression. Sapele Mahogany is a natural material where color and wood grain variation can occur from one piece of wood to another. Over time, small cracks at the tip of the wooden planks can occur due to the impact of weather. Furthermore, the wooden planks can, over time, warp a little resulting in a slight height difference between the wooden planks. When exposed to direct sunlight please note that objects placed on the table for a longer period of time can lead to color differences in the tabletop, this will however even itself out over time if the object is removed. The base is made from aluminum with a weather-resistant, UV-resistant powder coated finish suitable for outdoor use. Plastic glides for outdoor use.
Cleaning & Care	<p>When cared for properly, the 70/70 Outdoor Table is designed to last. Follow these simple rules to care for your design in the best possible way. To protect the 70/70 Outdoor Table from weather's harm when not in use, a cover can be purchased separately. Please make sure that both the table and the inside of the cover is completely dry before putting the cover on.</p> <p>Sapele Mahogany: Clean the table with a damp cloth following the grain of the wood. If necessary, use a mild detergent or dish-washing liquid, not concentrated. Always wipe with a clean damp cloth and then a dry cloth afterwards. To minimize the risk of stains and marks, liquid, grease etc. should be removed straight away.</p> <p>It is recommended to clean the tabletop 1-2 times a year using an outdoor wood cleaning product to remove algae and dirt. Please follow the instructions on the wood cleaning product. If untreated the tabletop will patinate over time and eventually turn a silver shade of grey. This patinated look does not affect the durability or quality of your table. If you wish to preserve or intensify the original Sapele Mahogany color, we recommend using a clear tabletop oil for outdoor use on a regular basis. Muuto recommends that you contact your local hardware store to get advice on tabletop oils for outdoor use.</p> <p>Base: Clean with a damp cloth. If necessary, use a little dish soap on the cloth. Always wipe with a clean damp cloth and then a dry cloth afterwards.</p> <p>Lacquered surfaces can be scratched and chipped if hit with hard objects. In case of minor scratches in the lacquer, Muuto recommends that you contact your local hardware store to get advice on which outdoor paint product is recommended to cover the minor scratches.</p>

	TESTS & CERTIFICATIONS
ANSI/BIFMA X5.5-2014	American National Standard for Office Furnishings-Desk Products.
EN 581-1:2017	Outdoor Furniture-General safety for domestic and contract.
EN 581-3:2017	Outdoor Furniture-Mechanical safety for domestic and contract tables.
EN 15372:2016 - L3	Extreme use. Furniture – Strength, durability and safety. Requirements for non-domestic tables.
Forest Stewardship Council™	Tabletop in FSC™-certified (FSC-CO28824) Sapele Mahogany.

70/70 OUTDOOR TABLE / 225 X 90 CM / 88.5 X 35.5"

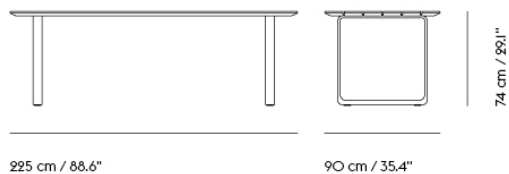

Shipper Colli	2
Gross Weight (kg)	78.8l
Net Weight (kg)	72.1
Base color options	Anthracite Black, Grey
Warranty Period	10 years

Pattern No.	Color	Contract Price	Lead Time
Ready-To-Ship US Warehouse			
M7070TO8936M-BLCK-MHGY	Sapele Mahogany/Anthracite Black	USD 4,041.00	-
M7070TO8936M-GREY-MHGY	Sapele Mahogany/Grey	USD 4,041.00	-
Extras			
13040	I3O4O	USD 23.00	-
MODCV-BLCK	Outdoor Cover for 70/70 Outdoor Table and Linear Steel Table 220 x 90 CM / 86.6 x 35.5	USD 299.00	-

AIRY COFFEE TABLE

"The idea behind Airy was to create a side table that did not scream but still was not afraid to speak. The result is a table series that masters the fine balance between being light and airy, and at the same time having plenty of personality and individuality. With this combination, Airy gets a multi-functionality that makes the side tables suitable for every kind of interior."

— Cecilie Manz



Designed by	Cecilie Manz
Environment	Indoor
Country of Production	Denmark
Assembly Required	Yes
Description	The Airy Coffee Table is designed with a light and airy expression through its clean lines and the tabletop almost floating above its thin steel frame. Available in four sizes, the Airy Coffee Table can serve a range of functions in a multitude of spaces with its playful yet quiet personality complementing any setting.
Material	Tabletop is made from plywood with a nanolaminate finish. Frame is made from 8 mm powder coated steel.
Cleaning & Care	Clean the table with a damp cloth. If necessary only use a mild detergent or washing up liquid and not concentrated. Always wipe with a dry cloth afterwards. To minimize the risk of stains and marks, liquid, grease etc. should be removed straight away. Treat the surface with a melamine sponge, available in hardware stores, to reduce minor scratches.

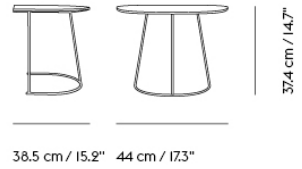

Shipper Colli 2
Gross Weight (kg) 4.514
Net Weight (kg) 3.1
Warranty Period 5 years

Pattern No.	Color	Contract Price	Lead Time
Ready-To-Ship US Warehouse			
MARYCT161715N-BLCK	Black Nanolaminate/Black	USD 331.00	-
MARYCT161715N-GREY	Grey Nanolaminate/Grey	USD 331.00	-
MARYCT161715N-OWHT	Off-White Nanolaminate/Off-White	USD 331.00	-
MARYCT161715N-PLUM	Plum Nanolaminate/Plum	USD 331.00	-
Extras			
83044	83044		-

AIRY COFFEE TABLE / SMALL

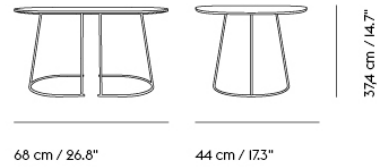

Shipper Colli	2
Gross Weight (kg)	6.262
Net Weight (kg)	4.71
Warranty Period	5 years

Pattern No.	Color	Contract Price	Lead Time
Ready-To-Ship US Warehouse			
MARYCT271715N-BLCK	Black Nanolaminate/Black	USD 530.00	-
MARYCT271715N-GREY	Grey Nanolaminate/Grey	USD 530.00	-
MARYCT271715N-OWHT	Off-White Nanolaminate/Off-White	USD 530.00	-
MARYCT271715N-PLUM	Plum Nanolaminate/Plum	USD 530.00	-
Extras			
83044	83044		-

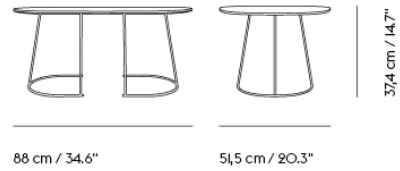

Shipper Colli 2
Gross Weight (kg) 7.852
Net Weight (kg) 6.21
Warranty Period 5 years

Pattern No.	Color	Contract Price	Lead Time
Ready-To-Ship US Warehouse			
MARYCT352015N-BLCK	Black Nanolaminate/Black	USD 614.00	-
MARYCT352015N-GREY	Grey Nanolaminate/Grey	USD 614.00	-
MARYCT352015N-OWHT	Off-White Nanolaminate/Off-White	USD 614.00	-
MARYCT352015N-PLUM	Plum Nanolaminate/Plum	USD 614.00	-
Extras			
83044	83044		-

AIRY COFFEE TABLE / LARGE

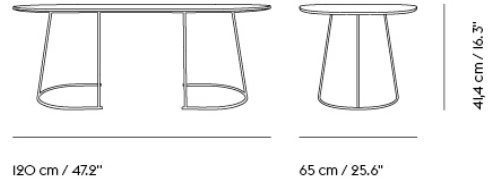

Shipper Colli	2
Gross Weight (kg)	11.646
Net Weight (kg)	9.56
Warranty Period	5 years

Pattern No.	Color	Contract Price	Lead Time
Ready-To-Ship US Warehouse			
MARYCT472616N-BLCK	Black Nanolaminate/Black	USD 797.00	-
MARYCT472616N-GREY	Grey Nanolaminate/Grey	USD 797.00	-
MARYCT472616N-OWHT	Off-White Nanolaminate/Off-White	USD 797.00	-
MARYCT472616N-PLUM	Plum Nanolaminate/Plum	USD 797.00	-
Extras			
83044	83044		-

AROUND COFFEE TABLE

“I wanted to create a modernly timeless perspective on the archetypal Scandinavian coffee table, taking inspiration from memories of visiting my grandparents’ house as a child and being nervous about spilling something from their coffee table and onto the beautiful carpets. This gave me the idea for Around Coffee Table with its subtle veneer frame. The design has an at once subtle and significant presence through its geometric legs, characterful frame and friendly opening for a forward-thinking take on Scandinavian craftsmanship.”

— Thomas Bentzen



Designed by	Thomas Bentzen
Environment	Indoor
Country of Production	Latvia
Assembly Required	Yes
Description	The Around Coffee Table brings a new perspective to its typology through the characterful wooden veneer frame that runs along the edge of the table, echoing the ideas of Scandinavian design. With its round shape and multiple sizes, the Around Coffee Table can be used in a multitude of settings, on its own or in groups, in any living room, lounge setting, lobby area or hotel room.
Material	Oak & Ash versions are made from oak or ash plywood and solid oak or ash legs. Colored versions are made from MDF or ash plywood and solid ash legs. All versions are made using FSC™-certified (FSC-CO28824) wood. The wood is carefully cut, bent, glued together and polished to create a unique table. The strong water-based lacquer surface protects the tables from wear and tear of everyday use.
Cleaning & Care	Clean the table with a damp cloth. If necessary only use a mild detergent or washing up liquid and not concentrated. Always wipe with a dry cloth afterwards. To minimize the risk of stains and marks, liquid, grease etc. should be removed straight away. Treat the surface with a melamine sponge, available in hardware stores, to reduce minor scratches.
	TESTS & CERTIFICATIONS
EN 15372:2016 - L3	Around Large and Extra Large: Extreme use. Furniture – Strength, durability and safety. Requirements for non-domestic tables.
VOC CDPH 01350 & VOC BIFMA X7.1.	Around Coffee Tables are tested to VOC CDPH 01350 and VOC BIFMA X7.1. Standard Test Method for Determining VOC Emissions from Office Furniture Systems, Components and Seating.
Global GreenTag GreenRate™	Around Coffee Tables are Global GreenTag GreenRate Level C-certified. <i>Please note: The Global GreenTag Label only applies for contract market orders with a minimum 5-year warranty.</i>
Forest Stewardship Council™	Made from FSC™-certified (FSC-CO28824) wood.

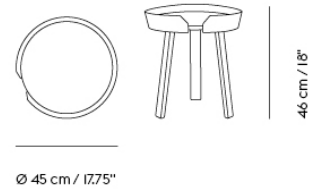

Shipper Colli 1
Gross Weight (kg) 3.82
Net Weight (kg) 2.94
Warranty Period 5 years

Pattern No.	Color	Contract Price	Lead Time
Ready-To-Ship US Warehouse			
MARDCT1818-OAK	Oak	USD 576.00	-
MARDCT1818-ANTH	Anthracite	USD 576.00	-
MARDCT1818-ASH	Ash	USD 576.00	-
MARDCT1818-BLCK	Black	USD 576.00	-
MARDCT1818-DKGN	Dark Green	USD 576.00	-
MARDCT1818-DGRN	Dusty Green	USD 576.00	-
MARDCT1818-GREY	Grey	USD 576.00	-
MARDCT1818-LTBU	Light Blue	USD 576.00	-
MARDCT1818-STDB	Stained Dark Brown	USD 576.00	-
MARDCT1818-TROS	Tan Rose	USD 576.00	-
MARDCT1818-WHIT	White	USD 576.00	-
Extras			
70700	70700		-

AROUND COFFEE TABLE / LARGE

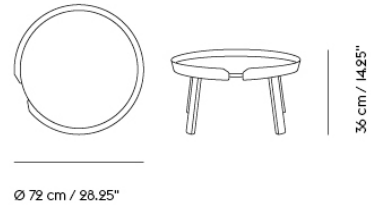

Shipper Colli 1
Gross Weight (kg) 7.06
Net Weight (kg) 5.92
Warranty Period 5 years

Pattern No.	Color	Contract Price	Lead Time
Ready-To-Ship US Warehouse			
MARDCT2814-OAK	Oak	USD 933.00	-
MARDCT2814-ANTH	Anthracite	USD 933.00	-
MARDCT2814-ASH	Ash	USD 933.00	-
MARDCT2814-BLCK	Black	USD 933.00	-
MARDCT2814-DGRN	Dusty Green	USD 933.00	-
MARDCT2814-GREY	Grey	USD 933.00	-
MARDCT2814-STDB	Stained Dark Brown	USD 933.00	-
MARDCT2814-WHIT	White	USD 933.00	-
Ready-To-Ship EU Warehouse			
MARDCT2814-DKGN	Dark Green	USD 933.00	-
Extras			
70700	70700		-

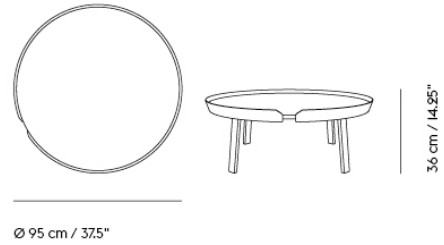

Shipper Colli 1
Gross Weight (kg) 13.06
Net Weight (kg) 10.52
Warranty Period 5 years

Pattern No.	Color	Contract Price	Lead Time
Ready-To-Ship US Warehouse			
MARDCT3814-OAK	Oak	USD 1,206.00	-
MARDCT3814-ANTH	Anthracite	USD 1,206.00	-
MARDCT3814-ASH	Ash	USD 1,206.00	-
MARDCT3814-BLCK	Black	USD 1,206.00	-
MARDCT3814-DGRN	Dusty Green	USD 1,206.00	-
MARDCT3814-GREY	Grey	USD 1,206.00	-
MARDCT3814-STDB	Stained Dark Brown	USD 1,206.00	-
MARDCT3814-WHIT	White	USD 1,206.00	-
Extras			
70700	70700		-

BASE TABLE SERIES

"I wanted the table to have its own character but not be imposing. The design aim was to reduce the table to its archetypal form. The functional simplicity of Base is supported by behind-the-scenes technology to create a slim, lightweight and strong table. At the same time, Base is friendly and welcoming in the way it looks."

— Mika Tolvanen



Designed by	Mika Tolvanen
Environment	Indoor
Country of Production	Denmark
Assembly Required	Yes
Description	The Base Table Series references the heritage of Scandinavian design through its simple frame and subtle details. With its design harking back to the essence of a table, the Base Table Series features a veneer edge for a touch of Scandinavian materiality, paired with the elegant shapes of its table top and frame. Use the design in any home, workplace, educational institution or hospitality space for notes of Scandinavian simplicity.
Material	Frame in powder coated aluminum with legs and stretcher in aluminum or steel for high tables. Bases available in Black or White. Castors with brakes available in Black or White matching the base color. Table top in plywood with either laminate, linoleum or lacquered oak veneer surface with plywood edge or chipboard with laminate surface and ABS edges.
Cleaning & Care	Clean the table with a damp cloth. If necessary use a mild detergent or washing up liquid and not concentrated. Always wipe with a dry cloth afterwards. To minimize the risk of stains and marks, liquids, grease etc. should be removed straight away. For linoleum versions, linoleum care is recommended for optimum saturation of the natural material 2-3 times a year. It is recommended to clean linoleum versions with a damp cloth and a pH neutral cleaner and wipe dry to remove any residues.
Spare Parts	Tables with two or four adjustable feet screws are made-to-order for all table sizes
Made-To-Order	Non-standard size tables are made to order with maximum width of 120 cm / 47.2" and minimum width of 50 cm / 19.7". Max. length (without legs) of 250 cm / 98.4" and min. length of 70 cm / 27.6". For tables longer than 250cm, additional leg support is needed; the top will be split into 2 parts and additional legs added. Laminate with ABS or plywood edge in Black or White. Linoleum with plywood edge. Our Cable Management Solution can be added to the Base Table. Additional lead time for non-standard sizes.
	TESTS & CERTIFICATIONS
EN 15372:2016 - L3	Severe use. Furniture – Strength, durability and safety. Requirements for non-domestic tables.
ANSI/BIFMA X5.5-2014*	American National Standard For Office. Furnishings - Desk products. <i>Please note: this test does not apply to tables in L 300 cm and 440 cm.</i>
VOC BIFMA X7.1.	Base Tables in veneer are tested to VOC BIFMA X7.1. Standard Test Method for Determining VOC Emissions from Office Furniture Systems, Components and Seating.

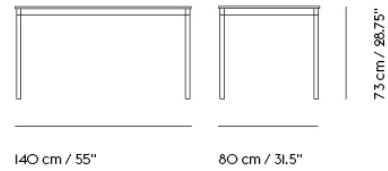

Shipper Colli	2
Gross Weight (kg)	25.7
Net Weight (kg)	22.3
Base color options	Black or White
Warranty Period	10 years

Pattern No.	Color	Contract Price	Lead Time
Ready-To-Ship US Warehouse			
MBTR553229LN-BLCK-WHIT-PLY	White Laminate/Plywood/Black	USD 1,626.00	-
MBTR553229LN-WHIT-WHIT-PLY	White Laminate/Plywood/White	USD 1,626.00	-
MBTR553229LN-BLCK-WHIT-WHIT	White Laminate/White ABS/Black	USD 1,626.00	-
MBTR553229LN-WHIT-WHIT-WHIT	White Laminate/White ABS/White	USD 1,626.00	-
MBTR553229VN-BLCK-OAK-PLY	Lacquered Oak Veneer/Plywood/Black	USD 2,046.00	-
MBTR553229VN-WHIT-OAK-PLY	Lacquered Oak Veneer/Plywood/White	USD 2,046.00	-
MBTR553229ON-BLCK-BLCK-PLY	Black Linoleum/Plywood/Black	USD 1,731.00	-
Ready-To-Ship EU Warehouse			
MBTR553229ON-WHIT-BLCK-PLY	Black Linoleum/Plywood/White	USD 1,731.00	-
Extras			
70701	70701	USD 23.00	-

BASE TABLE / 190 X 85 CM / 74.8 X 33.5"

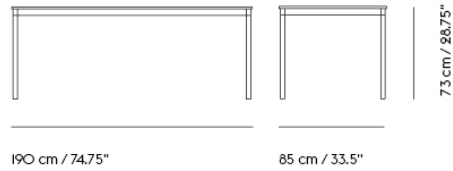

Shipper Colli	2
Gross Weight (kg)	33.9
Net Weight (kg)	28.09
Base color options	Black or White
Warranty Period	10 years

Pattern No.	Color	Contract Price	Lead Time
Ready-To-Ship US Warehouse			
MBTR753429LN-BLCK-WHIT-PLY	White Laminate/Plywood/Black	USD 1,836.00	-
MBTR753429LN-WHIT-WHIT-PLY	White Laminate/Plywood/White	USD 1,836.00	-
MBTR753429LN-BLCK-WHIT-WHIT	White Laminate/White ABS/Black	USD 1,836.00	-
MBTR753429LN-WHIT-WHIT-WHIT	White Laminate/White ABS/White	USD 1,836.00	-
MBTR753429VN-BLCK-OAK-PLY	Lacquered Oak Veneer/Plywood/Black	USD 2,515.00	-
MBTR753429VN-WHIT-OAK-PLY	Lacquered Oak Veneer/Plywood/White	USD 2,515.00	-
MBTR753429ON-BLCK-BLCK-PLY	Black Linoleum/Plywood/Black	USD 2,151.00	-
MBTR753429ON-WHIT-BLCK-PLY	Black Linoleum/Plywood/White	USD 2,151.00	-
Extras			
70701	70701	USD 23.00	-

BASE TABLE / 250 X 90 CM / 98.4 X 35.4"

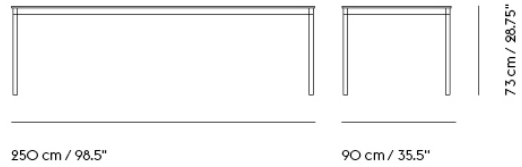

Shipper Colli	2
Gross Weight (kg)	46.7
Net Weight (kg)	40.08
Base color options	Black or White
Warranty Period	10 years

Pattern No.	Color	Contract Price	Lead Time
Ready-To-Ship US Warehouse			
MBTR993629LN-BLCK-WHIT-PLY	White Laminate/Plywood/Black	USD 2,515.00	-
MBTR993629LN-WHIT-WHIT-PLY	White Laminate/Plywood/White	USD 2,515.00	-
MBTR993629LN-BLCK-WHIT-WHIT	White Laminate/White ABS/Black	USD 2,515.00	-
MBTR993629LN-WHIT-WHIT-WHIT	White Laminate/White ABS/White	USD 2,515.00	-
MBTR993629VN-BLCK-OAK-PLY	Lacquered Oak Veneer/Plywood/Black	USD 3,411.00	-
MBTR993629VN-WHIT-OAK-PLY	Lacquered Oak Veneer/Plywood/White	USD 3,411.00	-
MBTR993629ON-BLCK-BLCK-PLY	Black Linoleum/Plywood/Black	USD 3,040.00	-
MBTR993629ON-WHIT-BLCK-PLY	Black Linoleum/Plywood/White	USD 3,040.00	-
Extras			
70701	70701	USD 23.00	-

BASE ROUND TABLE / Ø 110 CM / 43.3"

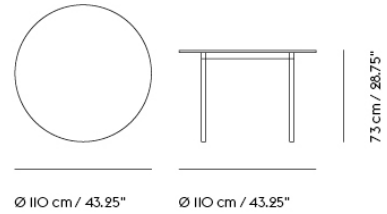

Shipper Colli	2
Gross Weight (kg)	19.1
Net Weight (kg)	14
Base color options	Black or White
Warranty Period	10 years

Pattern No.	Color	Contract Price	Lead Time
Ready-To-Ship EU Warehouse			
MBTO4329LN-BLCK-WHIT-PLY	White Laminate/Plywood/Black	USD 1,626.00	-
MBTO4329LN-WHIT-WHIT-PLY	White Laminate/Plywood/White	USD 1,626.00	-
MBTO4329ON-BLCK-BLCK-PLY	Black Linoleum/Plywood/Black	USD 1,836.00	-
MBTO4329ON-WHIT-BLCK-PLY	Black Linoleum/Plywood/White	USD 1,836.00	-
Extras			
70701	70701	USD 23.00	-

BASE HIGH TABLE / 190 X 50 H: 95 CM / 74.8 X 19.7 H: 37.4"

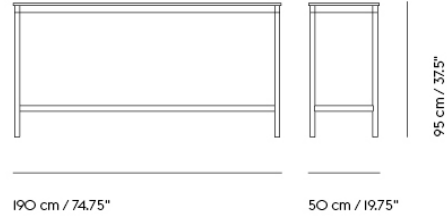

Shipper Colli	2
Gross Weight (kg)	38
Net Weight (kg)	33.2
Base color options	Black or White
Warranty Period	10 years

Pattern No.	Color	Contract Price	Lead Time
Ready-To-Ship US Warehouse			
MBHTR752038LN-BLCK-WHIT-PLY	White Laminate/Plywood/Black	USD 2,676.00	-
MBHTR752038LN-WHIT-WHIT-PLY	White Laminate/Plywood/White	USD 2,676.00	-
MBHTR752038LN-BLCK-WHIT-WHIT	White Laminate/White ABS/Black	USD 2,676.00	-
MBHTR752038LN-WHIT-WHIT-WHIT	White Laminate/White ABS/White	USD 2,676.00	-
MBHTR752038VN-BLCK-OAK-PLY	Lacquered Oak Veneer/Plywood/Black	USD 3,355.00	-
MBHTR752038VN-WHIT-OAK-PLY	Lacquered Oak Veneer/Plywood/White	USD 3,355.00	-
MBHTR752038ON-BLCK-BLCK-PLY	Black Linoleum/Plywood/Black	USD 3,040.00	-
MBHTR752038ON-WHIT-BLCK-PLY	Black Linoleum/Plywood/White	USD 3,040.00	-
Extras			
70702	70702	USD 46.00	-

BASE HIGH TABLE / 190 X 50 H: 105 CM / 74.8 X 19.7 H: 41.3"



Shipper Colli	2
Gross Weight (kg)	39
Net Weight (kg)	34.2
Base color options	Black or White
Warranty Period	10 years

Pattern No.	Color	Contract Price	Lead Time
Ready-To-Ship US Warehouse			
MBHTR752041LN-BLCK-WHIT-PLY	White Laminate/Plywood/Black	USD 2,676.00	-
MBHTR752041LN-WHIT-WHIT-PLY	White Laminate/Plywood/White	USD 2,676.00	-
MBHTR752041LN-BLCK-WHIT-WHIT	White Laminate/White ABS/Black	USD 2,676.00	-
MBHTR752041LN-WHIT-WHIT-WHIT	White Laminate/White ABS/White	USD 2,676.00	-
MBHTR752041VN-BLCK-OAK-PLY	Lacquered Oak Veneer/Plywood/Black	USD 3,355.00	-
MBHTR752041VN-WHIT-OAK-PLY	Lacquered Oak Veneer/Plywood/White	USD 3,355.00	-
MBHTR752041ON-BLCK-BLCK-PLY	Black Linoleum/Plywood/Black	USD 3,040.00	-
MBHTR752041ON-WHIT-BLCK-PLY	Black Linoleum/Plywood/White	USD 3,040.00	-
Extras			
70702	70702	USD 46.00	-

BASE HIGH TABLE / 190 X 85 H: 95 CM / 74.8 X 33.5 H: 37.4"

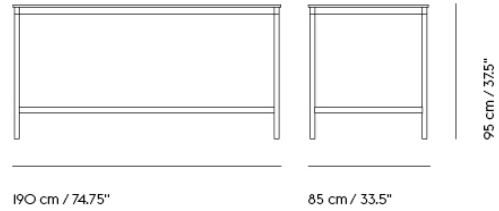

Shipper Colli	2
Gross Weight (kg)	44
Net Weight (kg)	37.25
Base color options	Black or White
Warranty Period	10 years

Pattern No.	Color	Contract Price	Lead Time
Ready-To-Ship US Warehouse			
MBHTR753438LN-BLCK-WHIT-PLY	White Laminate/Plywood/Black	USD 2,676.00	-
MBHTR753438LN-WHIT-WHIT-PLY	White Laminate/Plywood/White	USD 2,676.00	-
MBHTR753438LN-BLCK-WHIT-WHIT	White Laminate/White ABS/Black	USD 2,676.00	-
MBHTR753438LN-WHIT-WHIT-WHIT	White Laminate/White ABS/White	USD 2,676.00	-
MBHTR753438VN-BLCK-OAK-PLY	Lacquered Oak Veneer/Plywood/Black	USD 3,145.00	-
MBHTR753438VN-WHIT-OAK-PLY	Lacquered Oak Veneer/Plywood/White	USD 3,145.00	-
MBHTR753438ON-BLCK-BLCK-PLY	Black Linoleum/Plywood/Black	USD 3,040.00	-
MBHTR753438ON-WHIT-BLCK-PLY	Black Linoleum/Plywood/White	USD 3,040.00	-
Extras			
70702	70702	USD 46.00	-

BASE HIGH TABLE / 190 X 85 H: 105 CM / 74.8 X 33.5 H: 41.3"

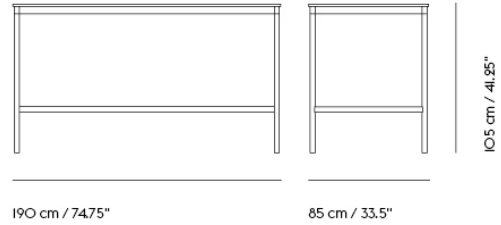

Shipper Colli	2
Gross Weight (kg)	45
Net Weight (kg)	38.25
Base color options	Black or White
Warranty Period	10 years

Pattern No.	Color	Contract Price	Lead Time
Ready-To-Ship US Warehouse			
MBHTR753441LN-BLCK-WHIT-PLY	White Laminate/Plywood/Black	USD 2,676.00	-
MBHTR753441LN-WHIT-WHIT-PLY	White Laminate/Plywood/White	USD 2,676.00	-
MBHTR753441LN-BLCK-WHIT-WHIT	White Laminate/White ABS/Black	USD 2,676.00	-
MBHTR753441LN-WHIT-WHIT-WHIT	White Laminate/White ABS/White	USD 2,676.00	-
MBHTR753441VN-BLCK-OAK-PLY	Lacquered Oak Veneer/Plywood/Black	USD 3,355.00	-
MBHTR753441VN-WHIT-OAK-PLY	Lacquered Oak Veneer/Plywood/White	USD 3,355.00	-
MBHTR753441ON-BLCK-BLCK-PLY	Black Linoleum/Plywood/Black	USD 3,040.00	-
MBHTR753441ON-WHIT-BLCK-PLY	Black Linoleum/Plywood/White	USD 3,040.00	-
Extras			
70702	70702	USD 46.00	-

BASE TABLE

Shipper Colli 2
 Warranty Period 5 years for L440 cm, L300 cm, L440 cm and Ø128 cm variants.
 10 years for all other variants

All dimensions of the Base Table are identical, both with and without castors.

All Variants

70 x 70 CM / 27.5 x 27.5 IN

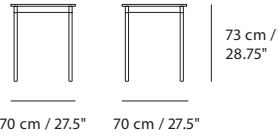

250 x 90 CM / 98.5 x 35.5 IN

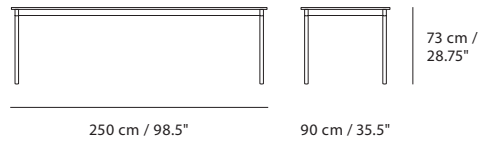

80 x 80 CM / 31.5 x 31.5 IN

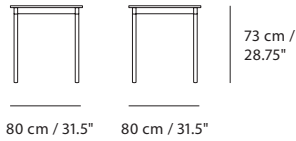

250 x 110 CM / 98.5 x 43.25 IN

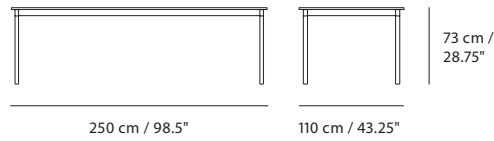

140 x 70 CM / 55 x 27.5 IN

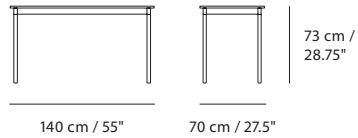

300 x 110 CM / 118 x 43.25 IN

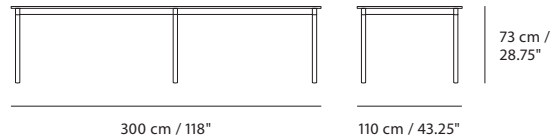

140 x 80 CM / 55 x 31.5 IN

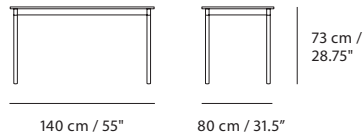

440 x 110 CM / 173.25 x 43.25 IN

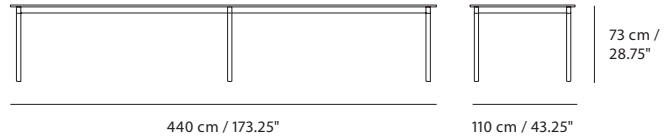

160 x 80 CM / 63 x 31.5 IN

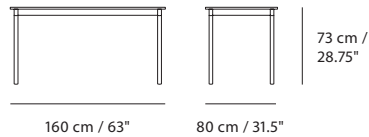

BASE ROUND TABLE

Ø 90 CM / 35.5 IN

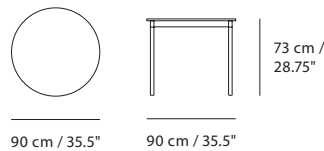

190 x 80 CM / 75 x 31.5 IN

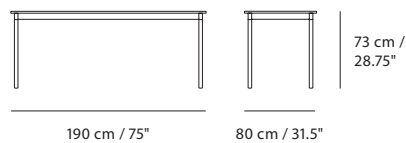

Ø 110 CM / 43.25 IN

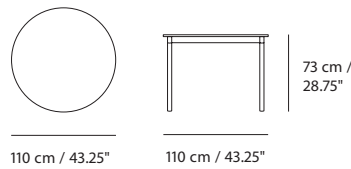

190 x 85 CM / 75 x 33.5 IN

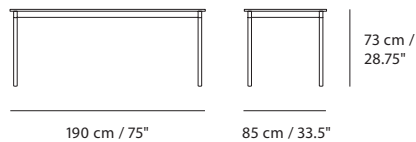

Ø 128 CM / 50.5 IN

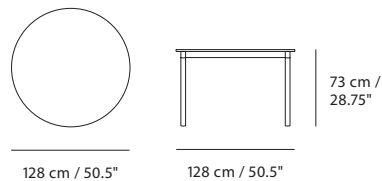

128 x 128 CM / 50.5 x 50.5 IN

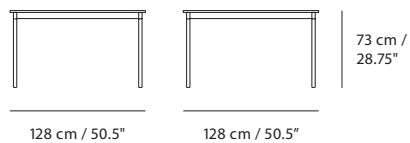

BASE TABLE

All Variants

Sizes	Pattern No.	Width/ diame- ter	Depth	Height	Weight (kg)	Contract Price						
							Laminate (L) w/ABS edge	Laminate (L) w/ply- wood edge	Linoleum (O) w/plywood edge	Oak veneer (V) w/plywood edge	Nanolami- nate (N) w/plywood edge	
Base Table Rectangular												
140 X 70 CM / 55.1 X 27.5"	M-BTR-55-28-29	55"	27.5"	28.75"	19.5	without castors with castors	1,626 1,731	1,626 1,731	1,675 1,885	1,731 2,046	2,046 2,256	
140 X 80 CM / 55.1 X 31.5"	M-BTR-55-32-29	55"	31.5"	28.75"	23	without castors with castors	1,626 1,731	1,626 1,731	1,731 2,046	2,046 2,151	2,256 2,410	
160 X 80 CM / 63 X 31.5 "	M-BTR-63-32-29	63"	31.5"	28.75"	23	without castors with castors	1,836 2,046	1,836 2,046	2,046 2,151	2,151 2,305	2,305 2,515	
190 X 80 CM / 74.8 X 31.5"	M-BTR-75-32-29	74.75"	31.5"	28.75"	26	without castors with castors	1,675 1,885	1,675 1,885	2,151 2,305	2,515 2,676	2,515 2,676	
190 X 85 CM / 74.8 X 33.5"	M-BTR-75-34-29	74.75"	33.5"	28.75"	30.5	without castors with castors	1,836 2,046	1,836 2,046	2,151 2,305	2,515 2,676	2,571 2,781	
250 X 90 CM / 98.4 X 35.4"	M-BTR-99-36-29	98.5"	35.5"	28.75"	42	without castors with castors	2,515 2,676	2,515 2,676	3,040 3,145	3,411 3,621	3,355 3,565	
250 X 110 CM / 98.4 X 43.3"	M-BTR-99-43-29	98.5"	43.5"	28.75"	47.5	without castors with castors	2,676 2,886	2,676 2,886	3,355 3,565	3,565 3,831	3,411 3,565	
300 X 110 CM / 118.1 X 43.3"	M-BTR-118-43-29	118"	43.5"	28.75"	50	without castors with castors	3,145 3,355	3,145 3,355	3,621 3,880	3,831 3,985	3,621 3,880	
440 X 110 CM / 173.3 X 43.3"	M-BTR-173-43-29	173"	43.5"	28.75"	64.5	without castors with castors	3,985 4,146	3,985 4,146	4,986 5,035	5,035 5,245	4,776 4,986	
Base Table Square												
70 X 70 CM / 27.6 X 27.6"	M-BTS-28-28-29	27.5"	27.5"	28.75"	13	without castors with castors	1,570 1,675	1,570 1,675	1,570 1,731	1,570 1,731	2,046 2,151	
80 X 80 CM / 31.5 X 31.5"	M-BTS-32-32-29	31.5"	31.5"	28.75"	15	without castors with castors	1,570 1,731	1,570 1,731	1,570 1,731	1,626 1,836	2,046 2,256	
128 X 128 CM / 50.4 X 50.4"	M-BTS-51-51-29	50.5"	50.5"	28.75"	27	without castors with castors	1,836 2,095	1,836 2,095	2,151 2,305	2,151 2,305	2,305 2,515	
Base Round Table												
Ø 90 CM / 35.4"	M-BTO-36-29	35.5"		28.75"	13.5	without castors with castors	1,626 1,731	1,626 1,731	1,731 2,046	1,836 2,046	2,151 2,305	
Ø 110 CM / 43.3 "	M-BTO-43-29	43.5"		28.75"	17.5	without castors with castors	1,626 1,836	1,626 1,836	1,836 2,046	1,836 2,095	2,151 2,305	
Ø 128 CM / 50.4"	M-BTO-51-29	50.5"		28.75"	21.5	without castors with castors	1,626 1,836	1,626 1,836	2,046 2,151	2,046 2,256	2,256 2,410	

HOW TO CONFIGURE

ORDER CODE EXAMPLE

Specify:

Base Table 28x28" in white laminate and white base

- Step 1) Select size
- Step 2) Select table top material"
- Step 3) Select castors (C) or without castors (N)"
- Step 4) Select base color"
- Step 5) Select table top color"
- Step 6) Select edge finish"

Size
Table top material
Choose castors (C) or without castors (N)
Base color
Table top finish
Edge finish
Final Pattern No:
Base Table Square 28"
Laminate
Castors
White base
White
Plywood
MBTS282829LCWHITWHITPLY

MBTS282829
L
C
WHIT
WHIT
PLY

Table Top Material	Base Color Options	Table Top Finish	Edge Finish Options
L - Laminate O - Linoleum V - Veneer N - Nanolaminate	WHIT - White BLCK - Black	Laminate WHIT - White BLCK - Black Linoleum BLCK - Black Veneer OAK - Oak Nanolaminate WHIT - White BLCK - Black	PLY - Plywood (available for all All Variants) WHIT - White ABS (available with laminate only) BLCK - Black ABS (available with laminate only)

BASE HIGH TABLE



Shipper Colli 2
 Warranty Period 5 years for L440 cm, L300 cm, L440 cm and Ø128 cm variants.
 10 years for all other variants

All dimensions of the Base High Table are identical, both with and without castors.

All Variants

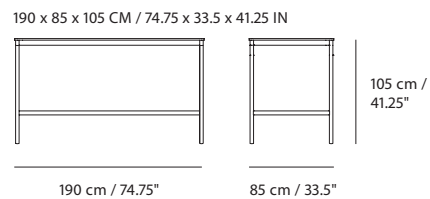
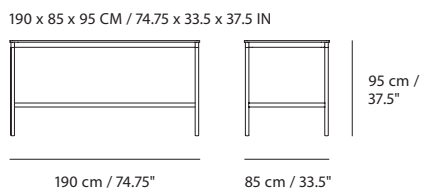
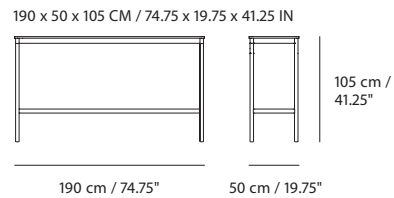
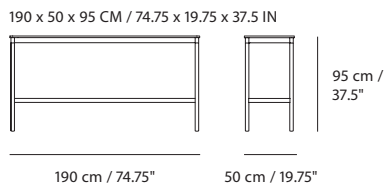
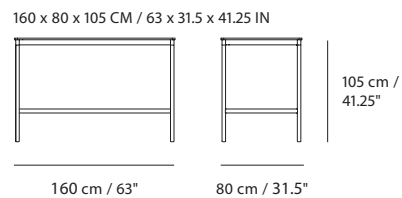
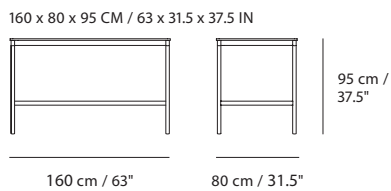
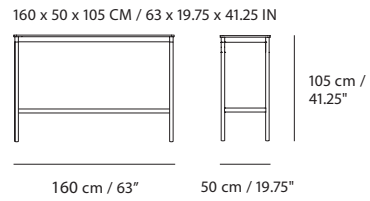
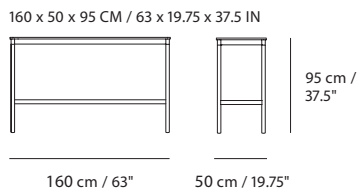

BASE HIGH TABLE

All Variants

Pattern No.	Width/ diameter rounded up	Depth	Height	Weight (kg)		Contract Price	Laminate (L) with ABS edge	Laminate (L) with plywood edge	Linoleum (O) with plywood edge	Oak Veneer (V) with plywood edge	Nanolami- nate (N) with plywood edge
M-BHTR-63-20-38	63"	19.75"	37.5"	32	without castors	2,571	2,571	2,886	3,040	3,145	
					with castors	2,781	2,781	3,096	3,145	3,355	
M-BHTR-63-20-41	63"	19.75"	41.25"	32.5	without castors	2,571	2,571	2,886	3,040	3,145	
					with castors	2,781	2,781	3,096	3,145	3,355	
M-BHTR-63-32-38	63"	31.5"	37.5"	32	without castors	2,571	2,571	2,886	3,040	3,145	
					with castors	2,781	2,781	3,096	3,145	3,355	
M-BHTR-63-32-41	63"	31.5"	41.25"	34	without castors	2,571	2,571	2,886	3,040	3,145	
					with castors	2,781	2,781	3,096	3,145	3,355	
M-BHTR-75-20-38	75"	19.75"	37.5"	34.5	without castors	2,676	2,676	3,040	3,355	3,565	
					with castors	2,886	2,886	3,145	3,565	3,831	
M-BHTR-75-20-41	75"	19.75"	41.25"	35	without castors	2,676	2,676	3,040	3,355	3,565	
					with castors	2,886	2,886	3,145	3,565	3,831	
M-BHTR-75-34-38	75"	33.5"	37.5"	40	without castors	2,676	2,676	3,040	3,145	3,355	
					with castors	2,886	2,886	3,145	3,565	3,565	
M-BHTR-75-34-41	75"	33.5"	41.25"	40.5	without castors	2,676	2,676	3,040	3,355	3,565	
					with castors	2,886	2,886	3,145	3,565	3,831	

HOW TO CONFIGURE

Base Table

- Step 1) Select Size
- Step 2) Select table top material
- Step 3) Select castors (C) or without castors (N)
- Step 4) Select Frame color
- Step 5) Select Table top color
- Step 6) Select Edge finish

ORDER CODE EXAMPLE

Base High Table Bar Height 63X19.7" in black linoleum and black frame

Size	Base High Table Bar Height Table 63X19.7"	MBHTR632041ON
Table top material	Linoleum	O
Choose castors (C) or without castors (N)	Without castors	N
Base color	Black	BLCK
Table top finish	Black	BLCK
Edge finish	Plywood	PLY
Final Pattern No:	MBHTR632041ONBLCKBLCKPLY	

Table Top Material	Base Color Options	Table Top Finish	Edge Finish Options
L - Laminate O - Linoleum V - Veneer N - Nanolaminate	WHIT - White BLCK - Black	Laminate WHIT - White BLCK - Black Linoleum BLCK - Black Veneer OAK - Oak Nanolaminate WHIT - White BLCK - Black	PLY - Plywood (available for all All Variants) WHIT - White ABS (available with laminate only) BLCK - Black ABS (available with laminate only)

CABLE MANAGEMENT SOLUTION

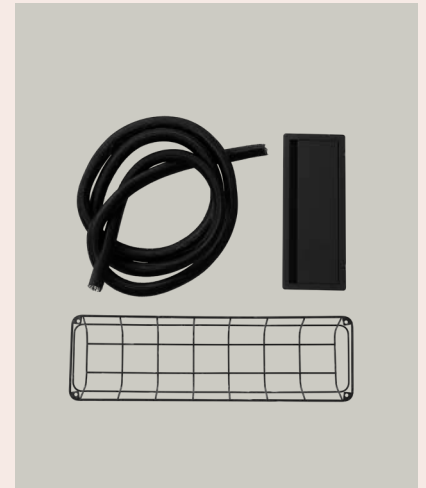

Environment	Indoor
Country of Production	Cable Guide: Denmark / Basket: China / Cable Pit: Denmark
Assembly Required	Yes
Description	<p>A Cable Management Solution that can be installed into tables to keep cables in order. The kit consists of cable pit for the tabletop, a wire basket for underneath the table, a cable guide and grips that can hold the table in place.</p> <p>Please note: the Cable Management Solution is sold as a separate product to the table and will not be delivered pre-installed to table but should instead be installed to table after purchase.</p>
Material	Cable Pit is made from aluminum. Cable Basket is made from Steel. Cable Guide is made from polyester.
Cleaning & Care	Clean cable pit with a damp cloth.

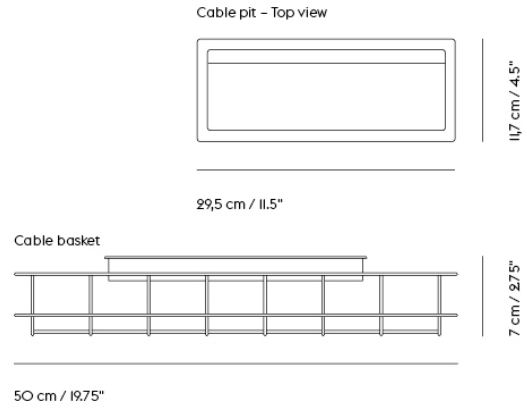

Shipper Colli 1
Gross Weight (kg) 0.6133
Net Weight (kg) 0.6133
Warranty Period 5 years

Pattern No.	Color	Contract Price	Lead Time
Ready-To-Ship US Warehouse			
MCBLPIT	Aluminum	USD 341.00	-
MCBLBKT	Black	USD 341.00	-

COMPILE SHELVING SYSTEM

"Storage is important because it is so universal: everybody needs good solutions. The inspiration for the Compile Shelving System was indeed the everyday storage situation. The design, with its logical construction, parallels to a certain degree an unpretentious Scandinavian lifestyle—one shelf represents one building unit while the length of the tube defines the shelf height. In this simple way one can assemble practical formations that fit individual needs—Compile should reflect and accommodate the life of which it is part."

— Cecilie Manz



Designed by	Cecilie Manz
Environment	Indoor
Country of Production	Poland
Assembly Required	Yes
Description	A contemporary take on the classic shelving system. Compile consists of a shelf and three heights of dividing tubes. Arrange the shelves and tubes as you please or order from the prearranged configurations.
Material	Powder coated steel.
Cleaning & Care	Remove dust from shelves with a soft cloth.
Additional Product Information	Compile systems should always be mounted to a wall, using wall brackets. A Compile Shelving System can hold up to 300 kg / 660 lbs. Compile Shelving Systems can be built as tall as wanted, as long as they are mounted to a wall using brackets. Muuto recommends not building Compile systems higher than 225 cm / 88.6".

TESTS & CERTIFICATIONS

ANSI/BIFMA X5.9-2019* American National Standard For Office Furnishings – Storage Units.
*Tested with wall brackets attached to the wall.

EN 16121:2013* Test severity I. Non-domestic storage furniture.
Requirements for safety, strength, durability and stability.

EN 16122:2012* Domestic and non-domestic storage furniture.
Test method for the determination of strength, durability and stability.

*Both tests were conducted using a 180 cm / 70.75" shelving configuration with wall brackets attached to the wall.

COMPILE SHELVING SYSTEM / CONFIGURATION I

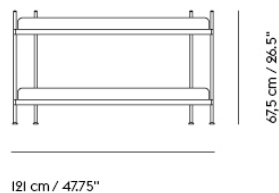
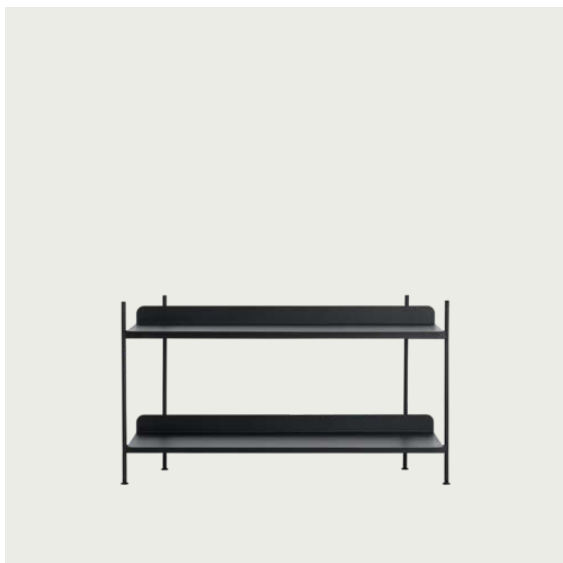

Shipper Colli 3
Gross Weight (kg) 22.74
Net Weight (kg) 18.27
Warranty Period 10 years

Pattern No.	Color	Contract Price	Lead Time
Ready-To-Ship EU Warehouse			
MCOMSC1-BLCK	Black	USD 866.00	-
MCOMSC1-GREY	Grey	USD 866.00	-
MCOMSC1-WHIT	White	USD 866.00	-

COMPILE SHELVING SYSTEM / CONFIGURATION 2

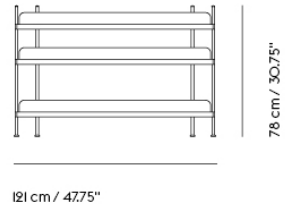

Shipper Colli 4
Gross Weight (kg) 33.55
Net Weight (kg) 27.11
Warranty Period 10 years

Pattern No.	Color	Contract Price	Lead Time
Ready-To-Ship EU Warehouse			
MCOMSC2-BLCK	Black	USD 1,255.00	-
MCOMSC2-GREY	Grey	USD 1,255.00	-
MCOMSC2-WHIT	White	USD 1,255.00	-

COMPILE SHELVING SYSTEM / CONFIGURATION 3



Shipper Colli 6
Gross Weight (kg) 55.96
Net Weight (kg) 45.49
Warranty Period 10 years

Pattern No.	Color	Contract Price	Lead Time
Ready-To-Ship EU Warehouse			
MCOMSC3-BLCK	Black	USD 2,046.00	-
MCOMSC3-GREY	Grey	USD 2,046.00	-
MCOMSC3-WHIT	White	USD 2,046.00	-

COMPILE SHELVING SYSTEM / CONFIGURATION 4

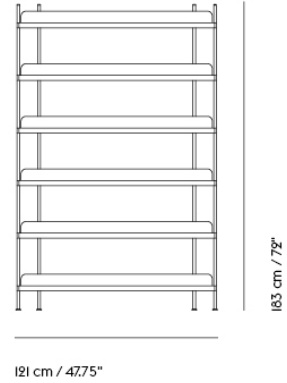

Shipper Colli 7
Gross Weight (kg) 67.16
Net Weight (kg) 54.69
Warranty Period 10 years

Pattern No.	Color	Contract Price	Lead Time
Ready-To-Ship EU Warehouse			
MCOMSC4-BLCK	Black	USD 2,410.00	-
MCOMSC4-GREY	Grey	USD 2,410.00	-
MCOMSC4-WHIT	White	USD 2,410.00	-

COMPILE SHELVING SYSTEM / CONFIGURATION 5

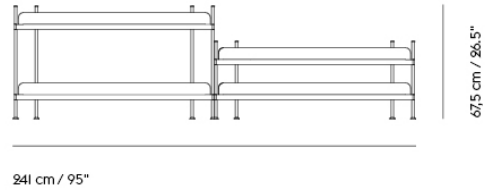

Shipper Colli 5
Gross Weight (kg) 44.85
Net Weight (kg) 36.24
Warranty Period 10 years

Pattern No.	Color	Contract Price	Lead Time
Ready-To-Ship EU Warehouse			
MCOMSC5-BLCK	Black	USD 1,836.00	-
MCOMSC5-GREY	Grey	USD 1,836.00	-
MCOMSC5-WHIT	White	USD 1,836.00	-

COMPILE SHELVING SYSTEM / CONFIGURATION 6

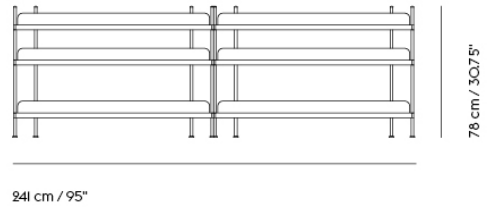

Shipper Colli 7
Gross Weight (kg) 66.81
Net Weight (kg) 54.21
Warranty Period 10 years

Pattern No.	Color	Contract Price	Lead Time
Ready-To-Ship EU Warehouse			
MCOMSC6-BLCK	Black	USD 2,571.00	-
MCOMSC6-GREY	Grey	USD 2,571.00	-
MCOMSC6-WHIT	White	USD 2,571.00	-

COMPILE SHELVING SYSTEM / CONFIGURATION 7

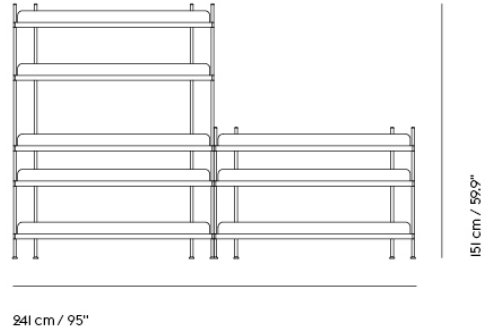

Shipper Colli 9
Gross Weight (kg) 89.22
Net Weight (kg) 72.6
Warranty Period 10 years

Pattern No.	Color	Contract Price	Lead Time
Ready-To-Ship EU Warehouse			
MCOMSC7-BLCK	Black	USD 3,516.00	-
MCOMSC7-GREY	Grey	USD 3,516.00	-
MCOMSC7-WHIT	White	USD 3,516.00	-

COMPILE SHELVING SYSTEM / CONFIGURATION 8

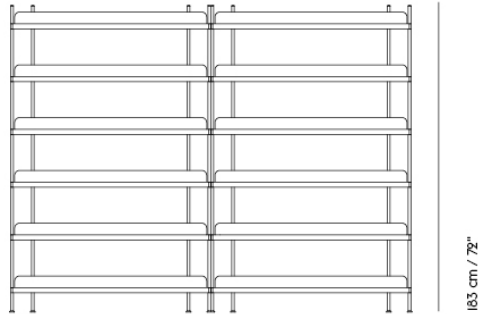

241 cm / 95"

Shipper Colli 13
 Gross Weight (kg) 134.03
 Net Weight (kg) 109.39
 Warranty Period 10 years

Pattern No.	Color	Contract Price	Lead Time
Ready-To-Ship EU Warehouse			
MCOMSC8-BLCK	Black	USD 4,881.00	-
MCOMSC8-GREY	Grey	USD 4,881.00	-
MCOMSC8-WHIT	White	USD 4,881.00	-

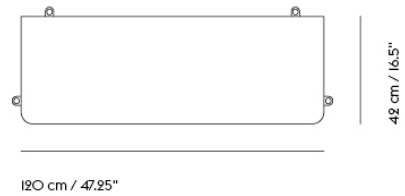

Shipper Colli 1
Gross Weight (kg) 10.67
Net Weight (kg) 8.7
Warranty period 10 years

Pattern No.	Color	Contract Price	Lead Time
Ready-To-Ship EU Warehouse			
MCOMSH-BLCK	Black	USD 383.00	-
MCOMSH-GREY	Grey	USD 383.00	-
MCOMSH-WHIT	White	USD 383.00	-

COMPILE SHELVING SYSTEM ESSENTIAL PACK

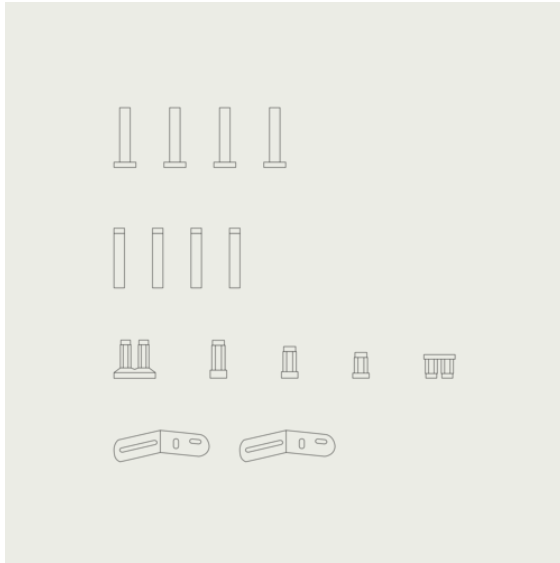

Shipper Colli 1
Gross Weight (kg) 0.5
Net Weight (kg) 0.3178
Warranty period 10 years

Pattern No.	Color	Contract Price	Lead Time
Ready-To-Ship EU Warehouse			
MCOMEP-BLCK	Black	USD 146.00	-
MCOMEP-GREY	Grey	USD 146.00	-
MCOMEP-WHIT	White	USD 146.00	-

COMPILE SHELVING SYSTEM DIVIDER PACK

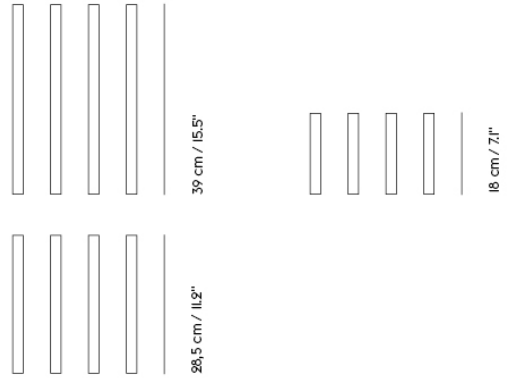
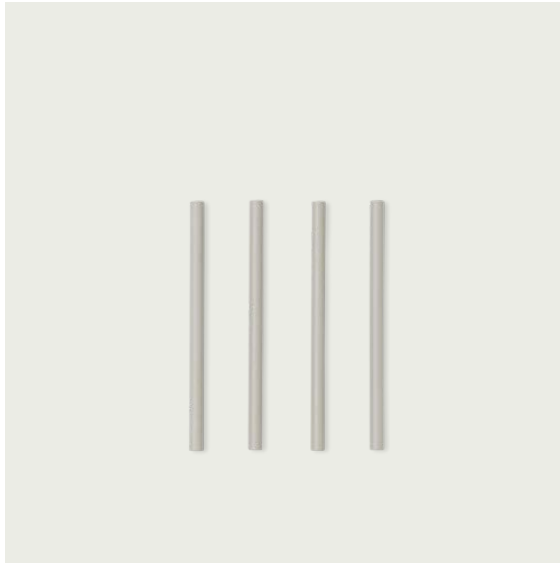

Shipper Colli 1
Gross Weight (kg) 0.28
Net Weight (kg) 0.253
Warranty period 10 years

Pattern No.	Color	Contract Price	Lead Time
Ready-To-Ship EU Warehouse			
MCOMSDLG-BLCK	Black - Large	USD 58.00	-
MCOMSDMD-BLCK	Black - Medium	USD 58.00	-
MCOMSDSM-BLCK	Black - Small	USD 58.00	-
MCOMSDLG-GREY	Grey - Large	USD 58.00	-
MCOMSDMD-GREY	Grey - Medium	USD 58.00	-
MCOMSDSM-GREY	Grey - Small	USD 58.00	-
MCOMSDLG-WHIT	White - Large	USD 58.00	-
MCOMSDMD-WHIT	White - Medium	USD 58.00	-
MCOMSDSM-WHIT	White - Small	USD 58.00	-

CONNECT MODULAR SOFA

"Connect is a modular seating system based on the idea of finding perfect proportional connections between the different components of the sofa. The design shows a precise attention to details and has architectural principles derived from modernism. The sleek long lines give the sofa a modern yet timeless expression. Connect the modules to create a sofa of your choice."

— Anderssen & Voll



Designed by	Anderssen & Voll
Environment	Indoor
Country of Production	Slovakia and Lithuania
Assembly Required	No
Description	The Connect Modular Sofa brings a modern perspective to the typology, allowing for its user to customize the sofa for their exact spatial and aesthetic needs with 14 different modules. Designed with long, elegant lines, the Connect Modular Sofa's details of its small feet underneath for a hovering, light sentiment and pointy corners allows for the design to bring character to any space, all while complementing and enhancing its surroundings. Use the Connect Modular Sofa for a modern comfort in any workplace, lounge area or hospitality setting. Visit our Product Planner to explore the possible configurations: planner.muuto.com/connect
Material	Seat and back frame are made of wood. The back frame is covered with cold foam filling and cotton wadding. The seat is made with zig-zag springs, felt, cold foam, and cotton wadding. Each module is upholstered in high-quality textiles or imitation leather and is kept together with connecting metal brackets.
Cleaning & Care	<p>For textile upholstered versions: In case of stains, we generally recommend removing non-greasy stains by carefully dabbing them with a lint-free cloth or sponge wrung out in clean, warm water. Clean by dabbing with soapy water made with a bit of dish soap if necessary. Finally, dab the surface with clean water. We advise visiting Kvadrat.dk, Nevotex.dk, Maharam.com, or Gabriel.dk for further cleaning and maintenance instructions for your chosen textile, as the cleaning methods may vary from one textile to another.</p> <p>Imitation Leather: Clean with lukewarm PH-neutral, soapy water and a soft cloth or soft brush. Do not use solvents or chemical cleaners, but cleaning can be done with alcohol-based cleaners. Finally, wipe with a damp cloth afterward.</p>
	CUSTOMIZED UPHOLSTERY
Module A+B	Textile upholstery: 5,8 m / 6.34 yds
Module C	Textile upholstery: 5,6 m / 6.1 yds
Module D	Textile upholstery: 4,7 m / 5.14 yds
Module E	Textile upholstery: 5,5 m / 6.1 yds
Module F+G	Textile upholstery: 5,1 m / 5.6 yds
Module H	Textile upholstery: 3,4 m / 3.7 yds
Module I	Textile upholstery: 2,9 m / 3.2 yds
Module J	Textile upholstery: 6,8 m / 7.4 yds
Module K	Textile upholstery: 6,8 m / 7.4 yds
Module L	Textile upholstery: 6,9 m / 7.6 yds
Module M	Textile upholstery: 6,3 m / 6.9 yds
Module N	Textile upholstery: 4,9 m / 5.4 yds

	TESTS & CERTIFICATIONS
EN 1022:2005	Domestic furniture - Seating - Determination of stability.
EN 16139:2013 - L2	Extreme use. Furniture - Strength, durability and safety. Requirements for non-domestic seating.
ANSI/BIFMA X5.4-2012	American National. Standard For Office Furnishings. Lounge and Public Seating.
Declare.	EU/US versions of the Connect Modular Sofa that are upholstered with a large selection of Kvadrat textiles ¹ are Living Building Challenge Red List Approved as part of Muuto's participation in Declare.
VOC CDPH 01350 & VOC BIFMA X7.I.	EU/US versions of the Connect Modular Sofa that are upholstered with a large selection of Kvadrat textiles ¹ are tested to VOC CDPH 01350 and VOC BIFMA X7.I.

¹Upholstered Muuto products that have the Declare Living Building Challenge Red List Approved certification only have the certification when upholstered with the following Kvadrat textiles: Balder, Canvas, Clara, Clay, Divina, Divina MD, Divina mélange, Fiord, Hallingdal, Hero, Remix, Re-wool, Steelcut, Steelcut Trio, Vidar, Twill weave.

Designed with long, elegant lines, the Connect Modular Sofa's details of its small feet underneath for a hovering, light sentiment and pointy corners allow for the design to bring character to any space.

Create your own Connect Modular Sofa by choosing from 11 modules, following the guidelines below.

Visit planner.muuto.com to create your own configuration online.

Create your own Connect Configuration

I . SEATING MODULES

Select your desired seating modules.

Add the item numbers of the desired textile separately to your order.

Note

You can only connect seating modules with pre-mounted linking brackets on the sides, illustrated here with dotted lines. Please note that the modules H & I can only be used as a freestanding ottoman and not part of the sofa configuration.

END MODULES

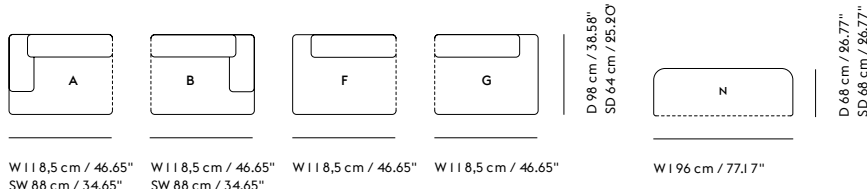

END & LOUNGE MODULES

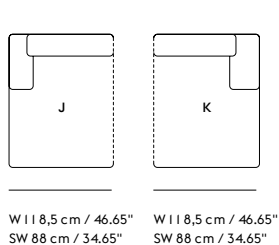

CENTER & CORNER MODULES

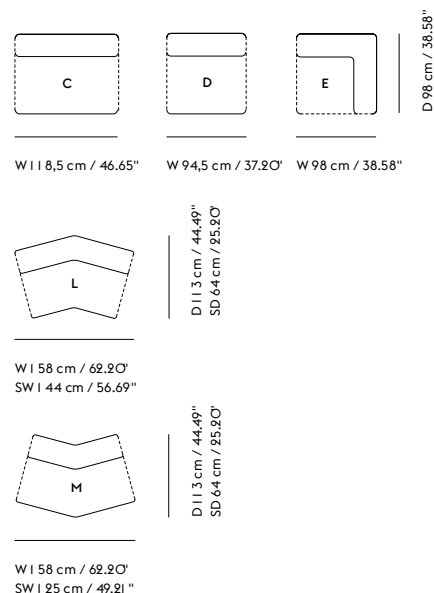

FREESTANDING MODULES

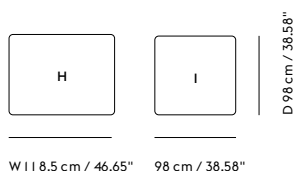

Textile direction

Corner Module E is designed to be used as corner. If used as End Module with armrest, the textile direction can differ. Modules connected on the left side of Corner Module E will have the same textile direction. The textile direction of modules connected on the right side will run into the opposite direction.

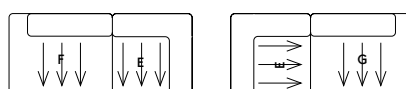

INSPIRATION FOR YOUR CONFIGURATION

2-seater Configurations

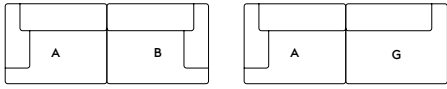

3-seater Configurations

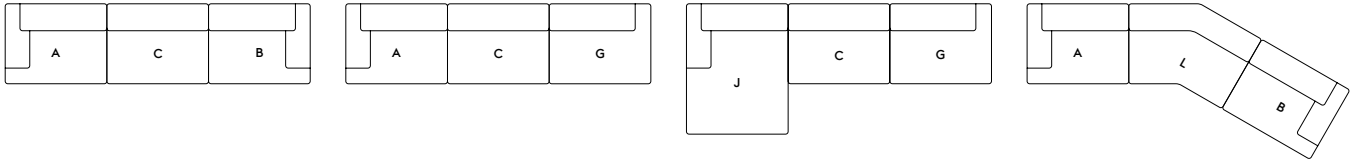

4-seater Configurations

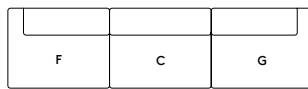

Corner Configuration

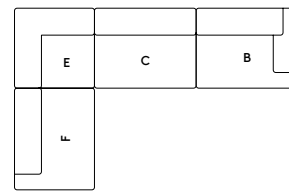

Back-To-Back Configurations

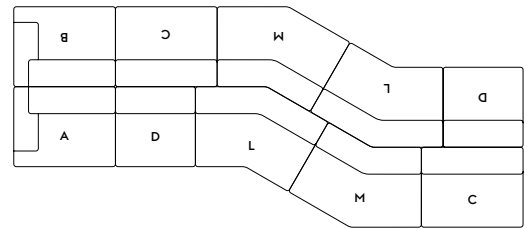
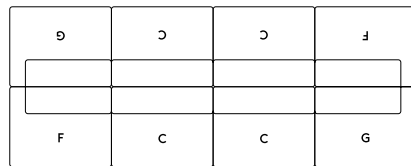
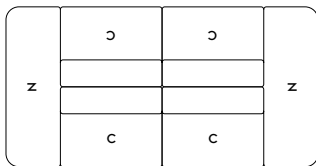

6-seater Configurations

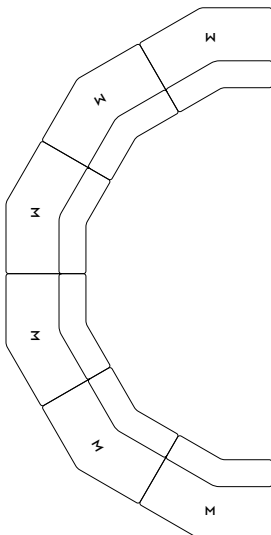

CONNECT MODULAR SOFA / LEFT ARMREST (A)

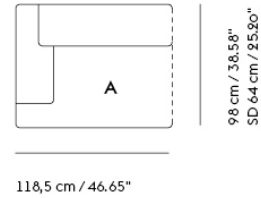

Shipper Colli	1
Gross Weight (kg)	55
Net Weight (kg)	50
Please note	This product features an armrest on the left-hand side when facing the product from the front.
Warranty Period	10 years

Pattern No.	Color	Contract Price	Lead Time
Ready-To-Ship US Warehouse			
MCONAML-M156123	Remix I23 ***	USD 2,305.00	-
MCONAML-K207410	Aegean IO	USD 2,886.00	-

CONNECT MODULAR SOFA / RIGHT ARMREST (B)

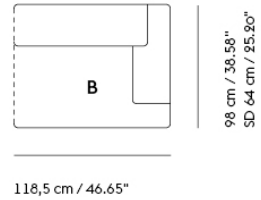

Shipper Colli	1
Gross Weight (kg)	55
Net Weight (kg)	50
Please note	This product features an armrest on the right-hand side when facing the product from the front.
Warranty Period	10 years

Pattern No.	Color	Contract Price	Lead Time
Ready-To-Ship US Warehouse			
MCONAMR-M156123	Remix I23 ***	USD 2,305.00	-
MCONAMR-K207410	Aegean IO	USD 2,886.00	-

CONNECT MODULAR SOFA / LONG CENTER (C)

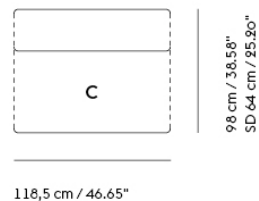

Shipper Colli	1
Gross Weight (kg)	48
Net Weight (kg)	43
Warranty Period	10 years

Pattern No.	Color	Contract Price	Lead Time
Ready-To-Ship US Warehouse			
MCONCML-M156123	Remix I23 ***	USD 2,305.00	-
MCONCML-M14813	Vancouver I3 ***	USD 2,305.00	-
MCONCML-K207410	Aegean IO	USD 2,886.00	-

CONNECT MODULAR SOFA / SHORT CENTER (D)

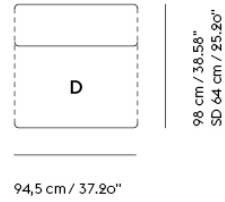

Shipper Colli | 1
Gross Weight (kg) | 32
Net Weight (kg) | 28
Warranty Period | 10 years

Pattern No.	Color	Contract Price	Lead Time
Ready-To-Ship US Warehouse			
MCONCMS-M156123	Remix I23 ***	USD 2,046.00	-
MCONCMS-K207410	Aegean IO	USD 2,410.00	-

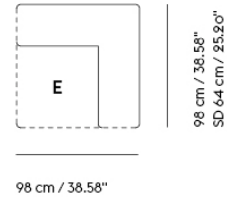

Shipper Colli 1
Gross Weight (kg) 54
Net Weight (kg) 50
Warranty Period 10 years

Pattern No.	Color	Contract Price	Lead Time
Ready-To-Ship US Warehouse			
MCONC-M156123	Remix I23 ***	USD 2,305.00	-
MCONC-K207410	Aegean IO	USD 2,830.00	-

CONNECT MODULAR SOFA / LEFT OPEN-ENDED (F)



118,5 cm / 46.65"

98 cm / 38.58"
SD 64 cm / 25.20"

Shipper Colli	1
Gross Weight (kg)	47
Net Weight (kg)	42
Please note	This product features an open end on the left-hand side when facing the product from the front.
Warranty Period	10 years

Pattern No.	Color	Contract Price	Lead Time
Ready-To-Ship US Warehouse			
MCONOML-M156123	Remix I23 ***	USD 2,305.00	-
MCONOML-M14813	Vancouver I3 ***	USD 2,305.00	-
MCONOML-K207410	Aegean IO	USD 2,620.00	-

CONNECT MODULAR SOFA / RIGHT OPEN-ENDED (G)



118,5 cm / 46.65"

98 cm / 38.58"
SD 64 cm / 25.20"

Shipper Colli	1
Gross Weight (kg)	47
Net Weight (kg)	42
Please note	This product features an open end on the right-hand side when facing the product from the front.
Warranty Period	10 years

Pattern No.	Color	Contract Price	Lead Time
Ready-To-Ship US Warehouse			
MCONOMR-M156123	Remix I23	USD 2,305.00	-
MCONOMR-K207410	Aegean IO	USD 2,620.00	-

CONNECT SOFA SERIES

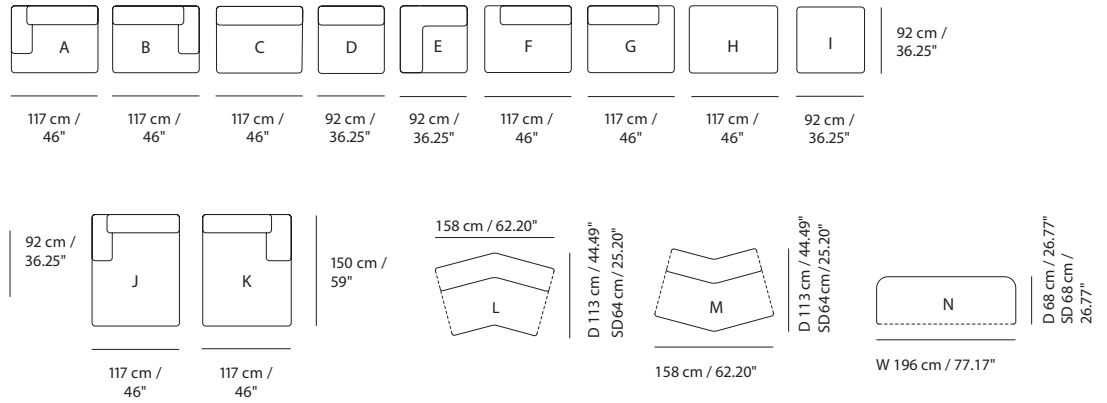

Shipper Colli 1
 Directional Modules Right and left refers to the side when facing the product from the front.
 Warranty Period 10 years

All Variants

Modules	Pattern No.	Weight (kg)	Contract Price Upholstery Grades			
			A	COM B	CIL C	E
Left Armrest (A)	M-CONAM-L	50	2,305	2,781	2,830	2,886
Right Armrest (B)	M-CONAM-R	50	2,305	2,781	2,830	2,886
Long Center (C)	M-CONCM-L	43	2,305	2,781	2,830	2,886
Short Center (D)	M-CONCM-S	28	2,046	2,256	2,361	2,410
Corner (E)	M-CONC	50	2,305	2,571	2,781	2,830
Left Open-ended (F)	M-CONOM-L	42	2,305	2,515	2,571	2,620
Right Open-Ended (G)	M-CONOM-R	42	2,305	2,515	2,571	2,620
Long Ottoman (H)	M-CONOTT-L	39	1,465	1,675	1,836	2,095
Short Ottoman (I)	M-CONOTT-S	27	1,416	1,570	1,731	1,836
Left Armrest Lounge (J)	M-CONLM-L	70	3,096	3,565	3,621	3,831
Right Armrest Lounge (K)	M-CONLM-R	70	3,096	3,565	3,621	3,831
Angle Module 150 degrees (L)	M-CONAN150	47	3,096	3,565	3,621	3,831
Angle Module 210 degrees (M)	M-CONAN210	44	3,096	3,565	3,621	3,831
End Module (N)	M-CONEND	31	2,305	2,781	2,830	2,886

HOW TO CONFIGURE

ORDER CODE EXAMPLE

Connect Sofa Connect sofa - A + D + B in Ocean 80

Specify:	Modules	Connect A + D + B	MCONAML MCONCMS MCONAMR
Step 1) Choose modules	Textile	Ocean	M161
Step 2) Choose Textile	Textile Color	80	80
Step 3) Choose Textile color	Final Pattern No.s (one per module)	MCONAMLM16180 MCONCMSM16180 MCONAMRM16180	

Upholstery Options

A	B	C	E
Ocean (M161)* Remix (M156) Vancouver (M148) Wooly (M159)	Canvas (M153) Clara (M154) Colline (M5416) Fiord (M155) Grain (M12659) Manner (M12665) Steelcut (M149) Steelcut Quartet (M13042) Steelcut Trio (M139)	Hallingdal (M146) Illusion (M12654)	Acca (M12660) Aegean (K2074) Beck (M6376) Clay (M2449)* Divina (M150) Divina MD (M147) Divina Melange (M135) Ecriture (M10767) Hearth (M12664) Planum (M5904) Twill Weave (M142) Vidar (M158)

*Notes:
 Ocean: Color 3, 21, 32, 50, 52, 80 & 601
 Clay - Color 1, 2, 3, 4, 5, 6, 7, 8, 9, 10, 11, 12, 13, 14, 15, 16 & 17
 Illusion - Black, Blue, Caribou, Chocolate, Ciel, Dark Green, Dark Caramel, Grey, Light Grey, Mink, Matrine, Petrol, Stone, Taupe, Tile

CONNECT SOFT MODULAR SOFA

"The Connect Soft Modular Sofa is a seating system, rooted in the idea of uncovering the perfect proportional connections between the different components within a sofa. Designed with a deep, low seat, loose upholstery and an inherently soft filling, the Connect Soft Modular Sofa is at once elegant and contemporary—a sentiment that is echoed through its small feet underneath for a hovering expression while its box stitching infuse it with a modern touch. The design adds a geometric and elegant perspective to the archetypal modular sofa, paired with an ultra-soft comfort for hours of lounging."

— Anderssen & Voll



Designed by	Anderssen & Voll
Environment	Indoor
Country of Production	Lithuania
Assembly Required	No
Description	The Connect Soft Modular Sofa brings together elegant and geometric proportions with a deeply inviting comfort. With its minutely-shaped forms, characterful corners and inherently soft seat, the Connect Soft Modular Sofa acts as the heart of any space while its modularity allows for its user to tailor the design to their exact taste and space.
Material	Seat and back frame made in FSC™-certified (FSC-CO28824) wood. Back frame is covered with cold-foam filling and wadding. Seat is made with zig-zag springs, felt, cold-foam and wadding. The module is upholstered in high-quality textiles, imitation leather or leather with a thin lining of wadding underneath. Modules are kept together with connecting metal brackets.
Cleaning & Care	<p>For textile upholstered versions: In case of stains, we generally recommend removing non-greasy stains by carefully dabbing with a lint-free cloth or sponge wrung out in clean warm water. If necessary, clean by dabbing with soapy water made with a little dish soap. Finally, dab the surface with clean water. We advise visiting Kvadrat.dk, Nevotex.dk, Maharam.com or Gabriel.dk for further cleaning and maintenance instructions for your chosen textile, as the cleaning methods may vary from one textile to another.</p> <p>Imitation Leather: Clean with lukewarm PH-neutral soapy water and a soft cloth or soft brush. Do not use solvents or chemical cleaners, but cleaning can be done with alcohol-based cleaners. Finally, wipe with a damp cloth afterwards.</p> <p>Leather: As a natural material, leather requires looking after. If you care for the leather in the right way, it will become even more beautiful over time.</p> <p>Refine Leather, Easy Leather and Endure Leather: Clean leather with a dry cloth regularly. treat the leather at least four times a year using only special leather treatment products. Visit ca-mo.com further information on cleaning leather.</p> <p>Allure and Grace Leather: Only vacuum clean with a soft brush. Never use soap or water otherwise the velvety look and feel will disappear. Do not apply leather grease or soak the leather. Avoid any chemical products, such as saddle soap, leather cleaners or household products.</p>

	CUSTOMIZED UPHOLSTERY
Module A+B	Textile upholstery: 4,1 m / 4.5 yds — Leather upholstery: 7,89 m ² / 84.9 ft ²
Module C+D	Textile upholstery: 3,6 m / 4.0 yds — Leather upholstery: 7,07 m ² / 76.1 ft ²
Module E	Textile upholstery: 3,2 m / 3.5 yds — Leather upholstery: 6,11 m ² / 65.8 ft ²
Module F	Textile upholstery: 4,2 m / 4.6 yds — Leather upholstery: 8,11 m ² / 87.3 ft ²
Module G+H	Textile upholstery: 5,0 m / 5.5 yds — Leather upholstery: 9,88 m ² / 106.4 ft ²
Module I	Textile upholstery: 3,3 m / 3.6 yds — Leather upholstery: 5,04 m ² / 54.3 ft ²
Cushion	Textile upholstery: 0,9 m / 1 yds — Leather upholstery: 0,86 m ² / 9.3 ft ²

	TESTS & CERTIFICATIONS
EN 16139:2013 - L2	Extreme use Furniture - Strength, durability and safety. Requirements for non-domestic seating.
EN 1021:2005	Domestic furniture - Seating - Determination of stability.
BIFMA X5.4 - 2020	American National Standard for Office Furnishings Lounge and Public Seating
VOC CDPH 01350 & VOC BIFMA X7.1.	EU/US versions of the Connect Soft Modular Sofa upholstered with Easy or Refine Leather and a large selection of Kvadrat textiles ¹ are tested to VOC CDPH 01350 and VOC BIFMA X7.1.
	¹ Upholstered Muuto products that have the Declare Living Building Challenge Red List Approved certification only have the certification when upholstered with the following Kvadrat textiles: Balder, Canvas, Clara, Clay, Divina, Divina MD, Divina mélange, Fiord, Hallingdal, Hero, Remix, Re-wool, Steelcut, Steelcut Trio, Vidar, Twill weave.
Forest Stewardship Council™	Seat and back frame made in FSC™-certified (FSC-CO28824) wood.

The Connect Soft Modular Sofa brings together elegantly slender proportions with a deeply inviting and ultra-soft comfort. Being at the heart of any space, its modularity allows for its user to tailor the design to their exact taste and space.

Choose between 9 predesigned configurations or create your own choosing from 9 seating modules and optional cushions, following the guidelines below.

Visit planner.muuto.com to create your own configuration online.

Create your own Connect Soft Configuration

1. SEATING MODULES

Select your desired seating modules.

Add the item numbers of the desired textile separately to your order.

Note

You can only connect seating modules with pre-mounted linking brackets on the sides, illustrated here with dotted lines. Pouf Module I can either be connected to other modules with pre-mounted linking brackets or be used as a freestanding module.

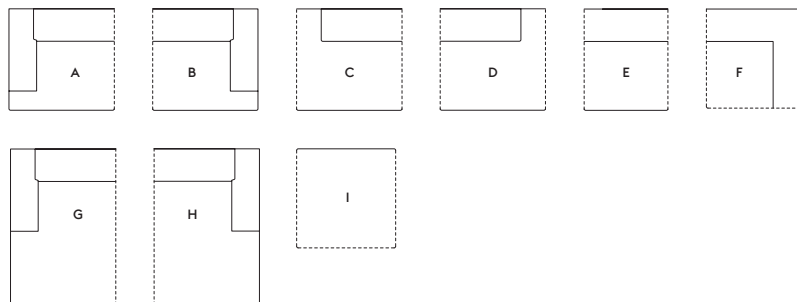

Textile direction

Corner Module F is designed to be used as corner. If used as End Module with armrest, the textile direction can differ. Modules connected on the left side of Corner Module F will have the same textile direction. The textile direction of modules connected on the right side will run into the opposite direction.



2. CUSHIONS

Specify optional cushions in the desired textile for added comfort and a lounging expression.

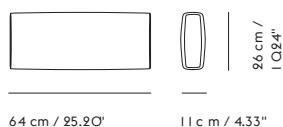

INSPIRATION FOR YOUR CONFIGURATION

2-seater Configurations

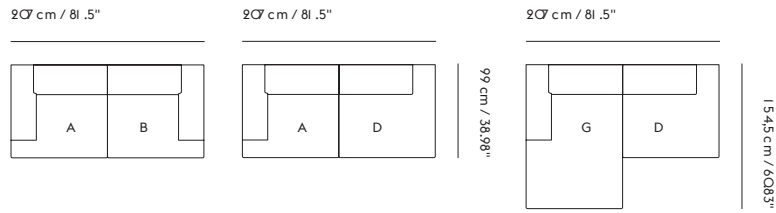

3-seater Configurations

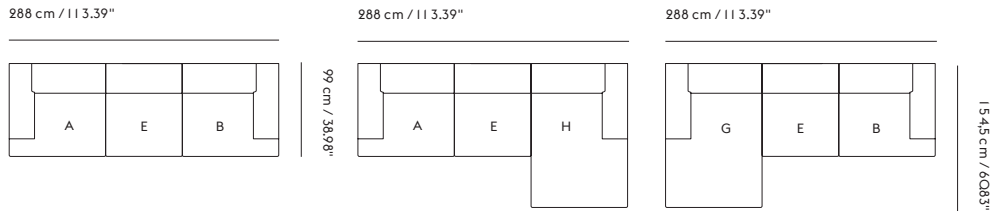

Corner Configurations

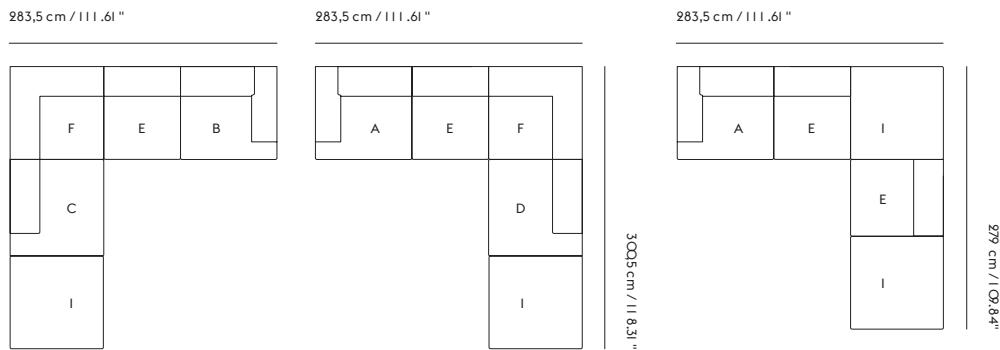

General note

The total dimensions of the configurations are indicative and can vary due to the inherent softness of the design and depending on how close the modules are placed as well as how many modules that are combined.

CONNECT SOFT MODULAR SOFA / LEFT ARMREST (A)

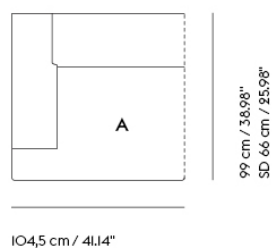
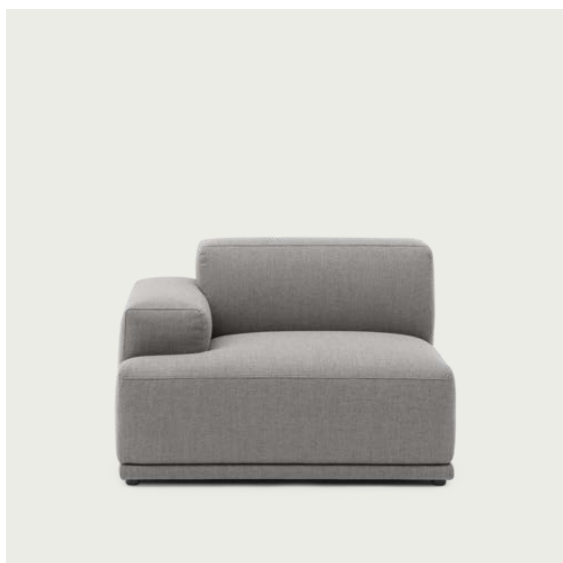

Shipper Colli	1
Gross Weight (kg)	50
Net Weight (kg)	38.3
Please note	This product features an armrest on the left-hand side when facing the product from the front.
Warranty Period	10 years

Pattern No.	Color	Contract Price	Lead Time
Ready-To-Ship US Warehouse			
MCONAMSL-M4586128	Re-wool 128	USD 2,781.00	-
MCONAMSL-M244912	Clay 12	USD 2,886.00	-
Extras			
MLEAKIT	Leather care set for Refine Leather	USD 27.00	-

CONNECT SOFT MODULAR SOFA / RIGHT ARMREST (B)

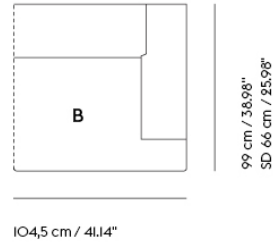

Shipper Colli	1
Gross Weight (kg)	50
Net Weight (kg)	38.3
Please note	This product features an armrest on the right-hand side when facing the product from the front
Warranty Period	10 years

Pattern No.	Color	Contract Price	Lead Time
Ready-To-Ship US Warehouse			
MCONAMSR-M4586128	Re-wool 128	USD 2,781.00	-
MCONAMSR-M244912	Clay 12	USD 2,886.00	-
Extras			
MLEAKIT	Leather care set for Refine Leather	USD 27.00	-

CONNECT SOFT MODULAR SOFA / LEFT OPEN-ENDED (C)

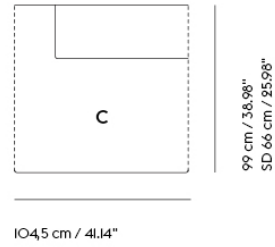

Shipper Colli	1
Gross Weight (kg)	46
Net Weight (kg)	34.3
Please note	This product features an open end on the left-hand side when facing the product from the front.
Warranty Period	10 years

Pattern No.	Color	Contract Price	Lead Time
Ready-To-Ship US Warehouse			
MCONOMSL-M4586128	Re-wool 128	USD 2,515.00	-
MCONOMSL-M244912	Clay 12	USD 2,620.00	-
Extras			
MLEAKIT	Leather care set for Refine Leather	USD 27.00	-

CONNECT SOFT MODULAR SOFA / RIGHT OPEN-ENDED (D)

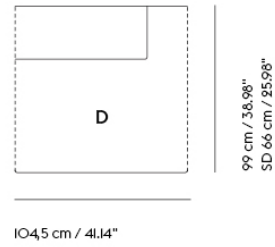

Shipper Colli	1
Gross Weight (kg)	46
Net Weight (kg)	34.3
Please note	This product features an open end on the right-hand side when facing the product from the front.
Warranty Period	10 years

Pattern No.	Color	Contract Price	Lead Time
Ready-To-Ship US Warehouse			
MCONOMSR-M4586128	Re-wool 128	USD 2,515.00	-
MCONOMSR-M244912	Clay 12	USD 2,620.00	-
Extras			
MLEAKIT	Leather care set for Refine Leather	USD 27.00	-

CONNECT SOFT MODULAR SOFA / CENTER (E)

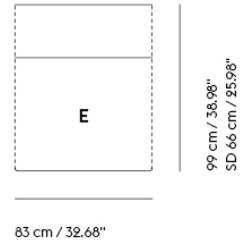

Shipper Colli | 1
Gross Weight (kg) | 42
Net Weight (kg) | 32.4
Warranty Period | 10 years

Pattern No.	Color	Contract Price	Lead Time
Ready-To-Ship US Warehouse			
MCONCMSS-M4586128	Re-wool I28	USD 2,256.00	-
MCONCMSS-M244912	Clay I2	USD 2,515.00	-
Extras			
MLEAKIT	Leather care set for Refine Leather	USD 27.00	-

CONNECT SOFT MODULAR SOFA / CORNER (F)

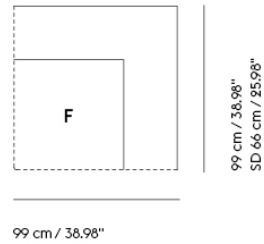

Shipper Colli | 1
Gross Weight (kg) | 50.8
Net Weight (kg) | 39.3
Warranty Period | 10 years

Pattern No.	Color	Contract Price	Lead Time
Ready-To-Ship US Warehouse			
MCONCS-M4586128	Re-wool I28	USD 2,571.00	-
MCONCS-M244912	Clay I2	USD 2,886.00	-
Extras			
MLEAKIT	Leather care set for Refine Leather	USD 27.00	-

CONNECT SOFT MODULAR SOFA / LEFT ARMREST CHAISE LOUNGE (G)

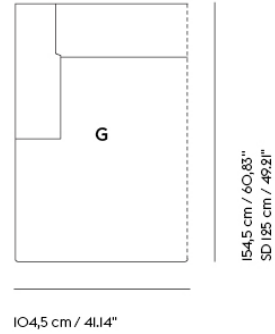

Shipper Colli	1
Gross Weight (kg)	67.2
Net Weight (kg)	52.1
Please note	This product features an armrest on the left-hand side when facing the product from the front.
Warranty Period	10 years

Pattern No.	Color	Contract Price	Lead Time
Ready-To-Ship US Warehouse			
MCONLMSL-M4586128	Re-wool 128/Black	USD 3,565.00	-
MCONLMSL-M244912	Clay 12/Black	USD 3,880.00	-
Extras			
MLEAKIT	Leather care set for Refine Leather	USD 27.00	-

CONNECT SOFT MODULAR SOFA / RIGHT ARMREST CHAISE LOUNGE (H)

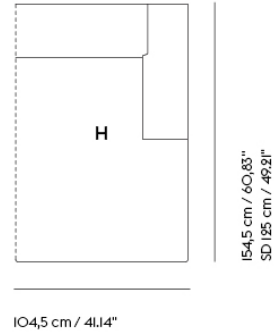

Shipper Colli	1
Gross Weight (kg)	67.2
Net Weight (kg)	52.1
Please note	This product features an armrest on the right-hand side when facing the product from the front.
Warranty Period	10 years

Pattern No.	Color	Contract Price	Lead Time
Ready-To-Ship US Warehouse			
MCONLMSR-M4586128	Re-wool 128/Black	USD 3,565.00	-
MCONLMSR-M244912	Clay 12/Black	USD 3,880.00	-
Extras			
MLEAKIT	Leather care set for Refine Leather	USD 27.00	-

CONNECT SOFT MODULAR SOFA / OTTOMAN (I)

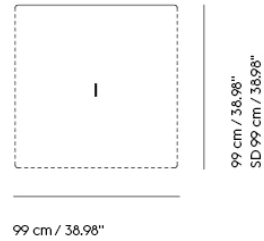

Shipper Colli I
Gross Weight (kg) 35.29
Net Weight (kg) 25.69
Warranty Period 10 years

Pattern No.	Color	Contract Price	Lead Time
Ready-To-Ship US Warehouse			
MCONOTTSS-M4586128	Re-wool I28	USD 1,836.00	-
MCONOTTSS-M244912	Clay I2	USD 2,095.00	-
Extras			
MLEAKIT	Leather care set for Refine Leather	USD 27.00	-

CONNECT SOFT MODULAR SOFA / 2-SEATER - CONFIGURATION I

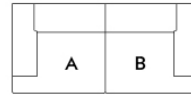

207 cm / 81.5"

99 cm / 38.98"
SD 66 cm / 25.98"

Shipper Colli 2
Gross Weight (kg) 100
Net Weight (kg) 76.6
Warranty Period 10 years

Pattern No.	Color	Contract Price	Lead Time
Ready-To-Ship US Warehouse			
MCONSPS2C1-M4586128	Re-wool I28	USD 5,406.00	-
MCONSPS2C1-M244912	Clay I2	USD 5,770.00	-
Extras			
MLEAKIT	Leather care set for Refine Leather	USD 27.00	-

CONNECT SOFT MODULAR SOFA / 2-SEATER - CONFIGURATION 2

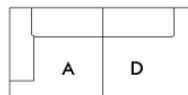
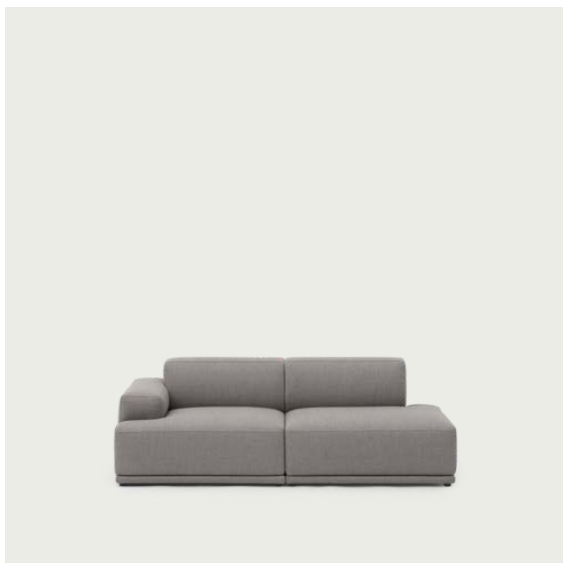

99 cm / 38.98"
SD 66 cm / 25.98"

207 cm / 81.5"

Shipper Colli 2
Gross Weight (kg) 96
Net Weight (kg) 72.6
Warranty Period 10 years

Pattern No.	Color	Contract Price	Lead Time
Ready-To-Ship US Warehouse			
MCONSPS2C2-M4586128	Re-wool I28	USD 5,140.00	-
MCONSPS2C2-M244912	Clay I2	USD 5,511.00	-
Extras			
MLEAKIT	Leather care set for Refine Leather	USD 27.00	-

CONNECT SOFT MODULAR SOFA / 2-SEATER - CONFIGURATION 3

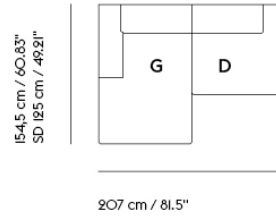

Shipper Colli 2
Gross Weight (kg) 113.2
Net Weight (kg) 86.4
Warranty Period 10 years

Pattern No.	Color	Contract Price	Lead Time
Ready-To-Ship US Warehouse			
MCONSPS2C3-M4586128	Re-wool 128	USD 5,875.00	-
MCONSPS2C3-M244912	Clay 12	USD 6,505.00	-
Extras			
MLEAKIT	Leather care set for Refine Leather	USD 27.00	-

CONNECT SOFT MODULAR SOFA / 3-SEATER - CONFIGURATION I



99 cm / 38.98"
SD 66 cm / 25.98"

288 cm / 113.39"

Shipper Colli 3
Gross Weight (kg) 142
Net Weight (kg) 109
Warranty Period 10 years

Pattern No.	Color	Contract Price	Lead Time
Ready-To-Ship US Warehouse			
MCONSPS3C1-M4586128	Re-wool 128	USD 7,506.00	-
MCONSPS3C1-M244912	Clay 12	USD 8,241.00	-
Extras			
MLEAKIT	Leather care set for Refine Leather	USD 27.00	-

CONNECT SOFT MODULAR SOFA / 3-SEATER - CONFIGURATION 2

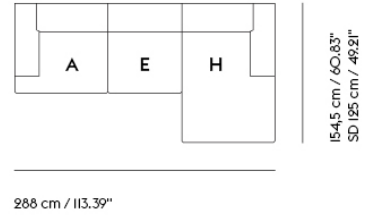

Shipper Colli 3
Gross Weight (kg) 159.2
Net Weight (kg) 122.8
Warranty Period 10 years

Pattern No.	Color	Contract Price	Lead Time
Ready-To-Ship US Warehouse			
MCONSPS3C2-M4586128	Re-wool 128	USD 8,290.00	-
MCONSPS3C2-M244912	Clay 12	USD 9,081.00	-
Extras			
MLEAKIT	Leather care set for Refine Leather	USD 27.00	-

CONNECT SOFT MODULAR SOFA / 3-SEATER - CONFIGURATION 3

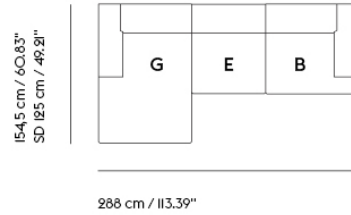

Shipper Colli 3
 Gross Weight (kg) 159.2
 Net Weight (kg) 122.8
 Warranty Period 10 years

Pattern No.	Color	Contract Price	Lead Time
Ready-To-Ship US Warehouse			
MCONSPS3C3-M4586128	Re-wool 128	USD 8,290.00	-
MCONSPS3C3-M244912	Clay 12	USD 9,081.00	-
Extras			
MLEAKIT	Leather care set for Refine Leather	USD 27.00	-

CONNECT SOFT MODULAR SOFA / CORNER - CONFIGURATION I

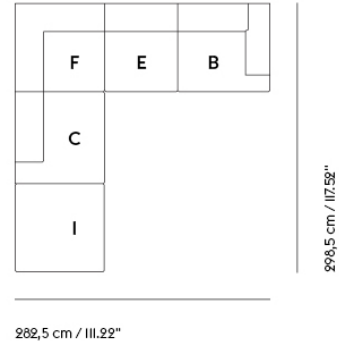

Shipper Colli 5
Gross Weight (kg) 224.09
Net Weight (kg) 169.99
Warranty Period 10 years

Pattern No.	Color	Contract Price	Lead Time
Ready-To-Ship US Warehouse			
MCONSPSCC1-M4586128	Re-wool I28	USD 11,545.00	-
MCONSPSCC1-M244912	Clay I2	USD 13,120.00	-
Extras			
MLEAKIT	Leather care set for Refine Leather	USD 27.00	-

CONNECT SOFT MODULAR SOFA / CORNER - CONFIGURATION 2

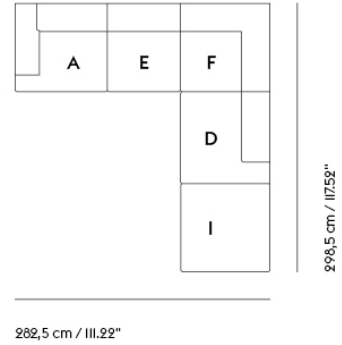

Shipper Colli 5
Gross Weight (kg) 224.09
Net Weight (kg) 169.99
Warranty Period 10 years

Pattern No.	Color	Contract Price	Lead Time
Ready-To-Ship US Warehouse			
MCONSPSCC2-M4586128	Re-wool 128	USD 11,545.00	-
MCONSPSCC2-M244912	Clay 12	USD 13,120.00	-
Extras			
MLEAKIT	Leather care set for Refine Leather	USD 27.00	-

CONNECT SOFT MODULAR SOFA / CORNER - CONFIGURATION 3

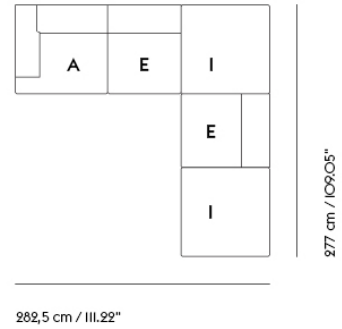

Shipper Colli 5
Gross Weight (kg) 204.58
Net Weight (kg) 154.48
Warranty Period 10 years

Pattern No.	Color	Contract Price	Lead Time
Ready-To-Ship US Warehouse			
MCONSPSCC3-M4586128	Re-wool I28	USD 10,390.00	-
MCONSPSCC3-M244912	Clay I2	USD 12,070.00	-
Extras			
MLEAKIT	Leather care set for Refine Leather	USD 27.00	-

CONNECT SOFT MODULAR SOFA CUSHION

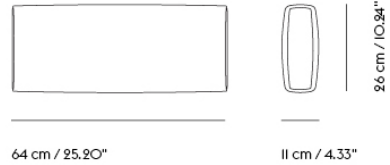

Shipper Colli 1
Gross Weight (kg) 1.3
Net Weight (kg) 0.1
Warranty Period 5 Years

Pattern No.	Color	Contract Price	Lead Time
Ready-To-Ship US Warehouse			
MCONSCUS2510-M4586128	Re-wool I28	USD 257.00	-
MCONSCUS2510-M244912	Clay I2	USD 289.00	-
Extras			
MLEAKIT	Leather care set for Refine Leather	USD 27.00	-

CONNECT SOFT MODULAR SOFA SERIES

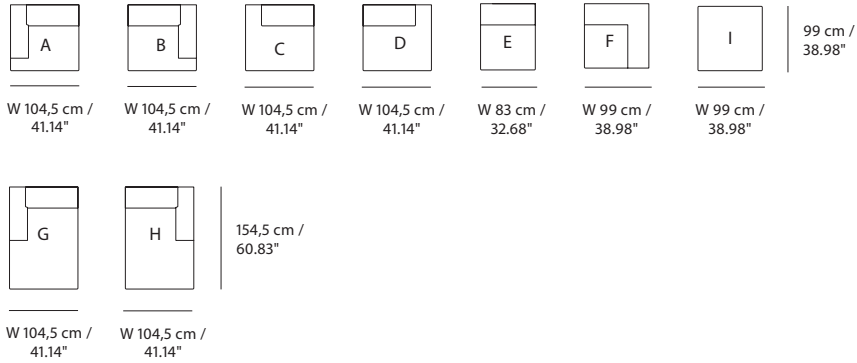

Shipper Colli 1
 Directional Modules Right and left refers to the side when facing the product from the front.
 Warranty Period 10 years

All Variants

Modules	Pattern No.	Weight (kg)	Contract Price Upholstery Grades									
			A	B	C	E	R	T	U	V	W	
Left Armrest (A)	M-CONAMS-L	39	2,305	2,781	2,830	2,886	3,565	4,356	4,671	5,301	5,826	
Right Armrest (B)	M-CONAMS-R	39	2,305	2,781	2,830	2,886	3,565	4,356	4,671	5,301	5,826	
Center (E)	M-CONCMSS	33	2,046	2,256	2,361	2,515	2,830	3,411	3,726	4,146	4,615	
Corner (F)	M-CONCS	40	2,305	2,571	2,781	2,886	3,565	4,356	4,671	5,301	5,826	
Left Open-ended (C)	M-CONOMS-L	35	2,305	2,515	2,571	2,620	3,306	3,985	4,251	4,881	5,301	
Right Open-Ended (D)	M-CONOMS-R	35	2,305	2,515	2,571	2,620	3,306	3,985	4,251	4,881	5,301	
Ottoman (I)	M-CONOTTSS	26	1,570	1,731	2,046	2,095	2,515	2,886	3,096	3,565	3,880	
Left Armrest Lounge (G)	M-CONLMS-L	53	3,096	3,565	3,621	3,880	4,615	5,560	6,036	6,820	7,450	
Right Armrest Lounge (H)	M-CONLMS-R	53	3,096	3,565	3,621	3,880	4,615	5,560	6,036	6,820	7,450	

HOW TO CONFIGURE

ORDER CODE EXAMPLE

Connect Soft Sofa Specify:	Connect soft sofa - A + D + B in Re-Wool 128 Modules	Connect A + D + B
Step 1) Choose modules	Textile	Re-Wool
Step 2) Choose Textile	Textile Color	128
Step 3) Choose Textile color	Final Pattern No.s (one per module)	M4586 128 MCONAMSL-M4586128 MCONOMSR-4586128 MCONAMSR-4586128

Upholstery Options

A	B	C	E	R	T	U	V	W
Ocean (M161)* Remix (M156) Vancouver (M148)	Canvas (M153) Clara (M154) Fiord (M155) Grain (M12659) Manner (M12665) Re-Wool (M4586) Sabi (M8404) Steelcut (M149) Steelcut Trio (M139)	Hallingdal (M146)	Acca (M12660) Beck (M6376) Divina (M150) Divina MD (M147) Divina Melange (M135) Ecriture (M10767) Hearth (M12664) Planum (M5904) Twill Weave (M142) Vidar (M158)	Easy Leather (M141)	Refine Leather (M136)	Endure Leather (M137)	Grace Leather (M12374)	Allure Leather (M12375)

*Notes:
 Ocean: Color 3, 21, 32, 50, 52, 80 & 601
 Clay - Color 1, 2, 3, 4, 5, 6, 7, 8, 9, 10, 11, 12, 13, 14, 15, 16 & 17

COUPLE COFFEE TABLE

"The Couple Coffee Table was born out of my research into a traditional and essential piece of furniture — the coffee table. I wanted to come up with a new yet subtle take on its typical materials and typology. I was inspired by the materiality of fired earth like brick and terracotta, finding that a beautiful synergy occurs when it is combined with wood. I have always been drawn to texture and wanted Couple's design to have an inherently tactile character produced by the grainy feel of the tile's surface. The design allows you to choose between or combine tiles with a smooth surface or a soft wavy look."

— Sylvain Willenz



Designed by	Sylvain Willenz
Environment	Indoor
Country of Production	Tiles: Italy / Frame: Romania
Assembly Required	Yes
Description	Inspired by the traditional tile table, the Couple Coffee Table is a refined merging of materials — FSC™-certified (FSC-CO28824) wood and ceramic stoneware. Made in a tactile ceramic stone material, it is a gentle nod to the durability of the brick, in aesthetics as well as quality. This sense of tactility is enhanced by the option of two different tabletop tiles; one with a plain and functional surface, the other with a more sculptural wavy feel. Choose between 36 prearranged variants spanning across various finishes and three sizes, from the petite to the grand coffee table with plenty of room for books and objects of affection.
Material	Tabletop tiles made in ceramic stoneware treated with a stone sealer for extra stain protection. Tiles are placed loosely on top of the frame with rubber anti-slip pads securing the tiles in place. Frame in solid oak treated with either clear or dark oil, made using FSC™-certified (FSC-CO28824) wood. Premounted felt glides.
Cleaning & Care	<p>Tabletop:</p> <p>For general maintenance: Clean the table with a damp cloth, using only mild (not concentrated) detergents or washing up liquids. Always dry with a cloth after cleaning. To avoid the risk of permanent stains and marks, liquid, grease, etc., these should be removed immediately. It is highly recommended to re-apply stone sealer 1-2 times a year on the tabletop surface in order to upkeep its stain-protection. Stone sealer can be purchased in your local hardware store*.</p> <p>Frame:</p> <p>We recommend applying special oak wood oil on the frame when necessary. For solid oak we recommend using an oil with a small amount of white pigment. For dark oiled oak we recommend using a smoked tabletop oil*. Never place the table in the immediate distance of a heat source.</p> <p>*Muuto recommends that you contact your local hardware store to get advice on oils and stone sealers for indoor use.</p>
EN 15379:2016 - L3	TESTS & CERTIFICATIONS Extreme use. Furniture – Strength, durability and safety. Requirements for non-domestic tables.
ANSI/BIFMA X5.5-2021	American National Standard for Office. Furnishings - Desk Products.
Forest Stewardship Council™	Table frame is made from FSC™-certified (FSC-CO28824) wood.

COUPLE COFFEE TABLE / 40 X 84 X 40 CM / 15.7 X 33.2 X 15.7"

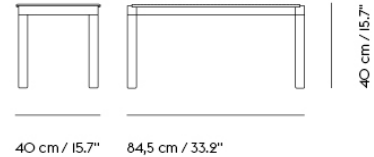

Shipper Colli	2
Gross Weight (kg)	16.24
Net Weight (kg)	13.86
Warranty	10 years

Pattern No.	Color	Contract Price	Lead Time
Ready-To-Ship US Warehouse			
MCOUP1PL-PABU-DOAK	1 Plain - Pale Blue/Dark Oiled Oak ***	USD 1,206.00	-
MCOUP1PL-PABU-OAK	1 Plain - Pale Blue/Oak ***	USD 1,206.00	-
MCOUP1PL-SAND-DOAK	1 Plain - Sand/Dark Oiled Oak	USD 1,206.00	-
MCOUP1PL-SAND-OAK	1 Plain - Sand/Oak	USD 1,206.00	-
MCOUP1PL-TAUP-DOAK	1 Plain - Taupe/Dark Oiled Oak	USD 1,206.00	-
MCOUP1PL-TAUP-OAK	1 Plain - Taupe/Oak	USD 1,206.00	-
MCOUP1WV-LTBU-DOAK	1 Wavy - Light Blue/Dark Oiled Oak	USD 1,206.00	-
MCOUP1WV-LTBU-OAK	1 Wavy - Light Blue/Oak	USD 1,206.00	-
MCOUP1WV-SAND-DOAK	1 Wavy - Sand/Dark Oiled Oak	USD 1,206.00	-
MCOUP1WV-SAND-OAK	1 Wavy - Sand/Oak	USD 1,206.00	-
MCOUP1WV-TAUP-DOAK	1 Wavy - Taupe/Dark Oiled Oak	USD 1,206.00	-
MCOUP1WV-TAUP-OAK	1 Wavy - Taupe/Oak	USD 1,206.00	-

COUPLE COFFEE TABLE / 80 X 84 X 40 CM / 31.5 X 33.2 X 15.7"

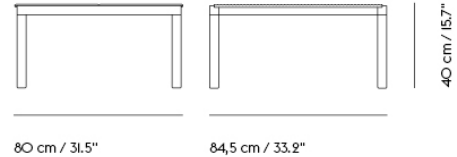

Shipper Colli	3
Gross Weight (kg)	29.78
Net Weight (kg)	25.52
Warranty	10 years

Pattern No.	Color	Contract Price	Lead Time
Ready-To-Ship US Warehouse			
MCOUP2PW-LTBU-DOAK	1 Plain Wavy - Light Blue/Dark Oiled Oak	USD 1,626.00	-
MCOUP2PW-LTBU-OAK	1 Plain Wavy - Light Blue/Oak	USD 1,626.00	-
MCOUP2PW-SAND-DOAK	1 Plain Wavy - Sand/Dark Oiled Oak	USD 1,626.00	-
MCOUP2PW-SAND-OAK	1 Plain Wavy - Sand/Oak	USD 1,626.00	-
MCOUP2PW-TAUP-DOAK	1 Plain Wavy - Taupe/Dark Oiled Oak	USD 1,626.00	-
MCOUP2PW-TAUP-OAK	1 Plain Wavy - Taupe/Oak	USD 1,626.00	-
MCOUP2PL-PABU-DOAK	2 Plain - Pale Blue/Dark Oiled Oak ***	USD 1,626.00	-
MCOUP2PL-PABU-OAK	2 Plain - Pale Blue/Oak ***	USD 1,626.00	-
MCOUP2PL-SAND-DOAK	2 Plain - Sand/Dark Oiled Oak	USD 1,626.00	-
MCOUP2PL-SAND-OAK	2 Plain - Sand/Oak	USD 1,626.00	-
MCOUP2PL-TAUP-DOAK	2 Plain - Taupe/Dark Oiled Oak	USD 1,626.00	-
MCOUP2PL-TAUP-OAK	2 Plain - Taupe/Oak	USD 1,626.00	-

**COUPLE COFFEE TABLE / 120 X 84 X 35
CM / 47.2 X 33.2 X 13.7"**

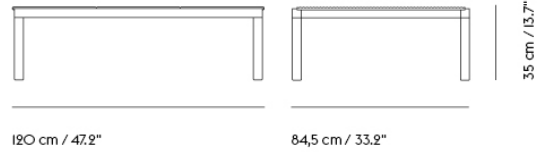

Shipper Colli 4
 Gross Weight (kg) 42.42
 Net Weight (kg) 36.28
 Warranty 10 years

Pattern No.	Color	Contract Price	Lead Time
Ready-To-Ship US Warehouse			
MCOUP3PW-LTBU-DOAK	2 Plain I Wavy - Light Blue/Dark Oiled Oak	USD 2,151.00	-
MCOUP3PW-LTBU-OAK	2 Plain I Wavy - Light Blue/Oak	USD 2,151.00	-
MCOUP3PW-SAND-DOAK	2 Plain I Wavy - Sand/Dark Oiled Oak	USD 2,151.00	-
MCOUP3PW-SAND-OAK	2 Plain I Wavy - Sand/Oak	USD 2,151.00	-
MCOUP3PW-TAUP-DOAK	2 Plain I Wavy - Taupe/Dark Oiled Oak	USD 2,151.00	-
MCOUP3PW-TAUP-OAK	2 Plain I Wavy - Taupe/Oak	USD 2,151.00	-
MCOUP3PL-PABU-DOAK	3 Plain - Pale Blue/Dark Oiled Oak ***	USD 2,151.00	-
MCOUP3PL-PABU-OAK	3 Plain - Pale Blue/Oak ***	USD 2,151.00	-
MCOUP3PL-SAND-DOAK	3 Plain - Sand/Dark Oiled Oak	USD 2,151.00	-
MCOUP3PL-SAND-OAK	3 Plain - Sand/Oak	USD 2,151.00	-
MCOUP3PL-TAUP-DOAK	3 Plain - Taupe/Dark Oiled Oak	USD 2,151.00	-
MCOUP3PL-TAUP-OAK	3 Plain - Taupe/Oak	USD 2,151.00	-

COVER CHAIR SERIES

"The Cover Chair Series is born from a desire to create a comfortable and contemporary chair in wood. I aimed for a crisp and vivid expression in the plywood while looking for a solid and grounded look in the frame and base of the design. Years of play and hard work in the making has resulted in a light, yet strong chair design that takes the material of veneer to its extreme."

— Thomas Bentzen



Designed by	Thomas Bentzen
Environment	Indoor
Country of Production	Armchair & Lounge Chair in Latvia / Bar Stool, Counter Stool & Side Chair in Romania
Assembly Required	No
Description	<p>Referencing the values of honest craftsmanship and Scandinavian materiality, the Cover Chair Series is an elegant perspective on the timeless wooden armchair. With its curved backrest and folded armrest covers, the Cover Chair Series explores the possibilities of wooden veneer, paired with a deep comfort, modern expression and base in solid wood. Echoing the seamless appearance of the chair, it features no visible screws for a simple touch. Use the Cover Chair Series in the living room, hallway or bedroom of the home as well as in restaurants, canteens, educational institutions, workplaces and more.</p> <p>The Cover Series without upholstery is EU Ecolabel Certified. By carrying the EU Ecolabel Certification, the product is guaranteed to have a reduced environmental impact throughout the total lifecycle of the product from raw material to disposal.</p>
Material	<p>The Cover Chair Series is made from form-pressed wood. The wood is folded over the chair's legs and backrest. This technically innovative wood layering helps lock the elements of the chair together. Upholstered seats with textile, imitation leather, or leather. Leather from selected premium leather suppliers.</p> <p>Cover Armchair: Oak and Stained Dark Brown versions: The back, seat, and armrests in oak veneer, solid oak frame, and legs. Water-based lacquer. Plastic glides. Colored versions: The back, seat, and armrest in ash veneer, frame, and legs are made from solid beech wood. Water-based lacquer. Plastic glides. Oak veneer and Stained Dark Brown: slight color variations can occur due to the inherent characteristics of the material.</p> <p>Cover Lounge Chair: Back and seat in oak veneer, solid oak frame and legs. Water-based lacquer. Plastic glides. Oak veneer and Stained Dark Brown: slight color variations can occur due to the inherent characteristics of the material.</p> <p>Cover Side Chair: Back and seat in oak veneer, solid oak frame and legs. Water-based lacquer. Plastic glides. Oak veneer and Stained Dark Brown: slight color variations can occur due to the inherent characteristics of the material.</p> <p>Cover Bar & Counter Stool: Back and seat in oak veneer, solid oak frame and legs. Made using FSC™-certified (FSC-CO28824) wood. Water-based lacquer. Footrest protector for bar and counter stool in tumbled stainless steel. Plastic glides. Oak veneer and Stained Dark Brown: slight color variations can occur due to the inherent characteristics of the material.</p>

Cleaning & Care

Clean with a moist cloth first and wipe off excess liquid with a dry cloth.

Upholstered versions:

Textile: In case of stains, we generally recommend removing non-greasy stains by carefully dabbing with a lint-free cloth or sponge wrung out in clean warm water. If necessary, clean by dabbing with soapy water made with a little dish soap. Finally, dab the surface with clean water. We highly recommend that you go to kvadrat.dk for further cleaning and maintenance instructions for your chosen textile, as the cleaning methods may vary from one textile to another.

Imitation Leather: Clean with lukewarm PH-neutral, soapy water and a soft cloth or soft brush. Do not use solvents or chemical cleaners, but cleaning can be done with alcohol-based cleaners. Finally, wipe with a damp cloth afterward.

Leather:

As a natural material, leather requires looking after. If you care for the leather correctly, it will become even more beautiful over time.

Refine Leather, Easy Leather, and Endure Leather: Clean leather with a dry cloth regularly. Treat the leather at least four times a year using only special leather treatment products. Visit ca-mo.com for further information on cleaning leather.

Allure and Grace Leather: Only vacuum clean with a soft brush. Never use soap or water; otherwise, the velvety look and feel will disappear. Do not apply leather grease or soak the leather. Avoid chemical products, such as saddle soap, leather cleaners, or household products.

Spare Parts

Pre-mounted plastic glides included. Felt and plastic glides can be purchased separately.

CUSTOMIZED UPHOLSTERY

Armchair

Textile upholstery: 0,55 m / 0.61 yds — Leather upholstery: 0,57 m² / 6.2 ft²

Side Chair

Textile upholstery: 0,55 m / 0.61 yds — Leather upholstery: 0,57 m² / 6.2 ft²

Bar & Counter Stool

Textile upholstery: 0,55 m / 0.61 yds — Leather upholstery: 0,57 m² / 6.2 ft²

Lounge Chair

Textile upholstery: 0,6 m / 0.66 yds — Leather upholstery: 0,7 m² / 7.54 ft²

	TESTS & CERTIFICATIONS
EN I6139:2013 - L2	Extreme use Furniture - Strength, durability and safety. Requirements for non-domestic seating.
EN IO22:2005	Domestic furniture - Seating - Determination of stability.
ANSI/BIFMA X5.4 - 2012	Cover Arm Chair, Side Chair and Lounge Chair: American National Standard For Office Furnishings - Lounge and public seating.
ANSI/BIFMA X5.4 - 2020	Cover Bar and Counter Chair: American National Standard For Office Furnishings - Lounge and public seating.
Forest Stewardship Council™	Cover Bar & Counter Stool are made using FSC™-certified (FSC-CO28824) wood.
EU Ecolabel	The Cover Series without upholstery is EU Ecolabel Certified. By carrying the EU Ecolabel Certification, the product is guaranteed to have a reduced environmental impact throughout the total lifecycle of the product from raw material to disposal.
Declare.	Cover Armchair, Bar & Counter Stool without upholstery and EU/US versions upholstered with a large selection of Kvadrat textiles ¹ are Living Building Challenge Red List Approved as part of Muuto's participation in Declare.
VOC CDPH 01350 & VOC BIFMA X7.1.	Cover Chair Series, without upholstery and EU/US versions upholstered with Easy or Refine Leather and a large selection of Kvadrat textiles ¹ are tested to VOC CDPH 01350 and VOC BIFMA X7.1.
Global GreenTag Green-Rate™	Cover Armchair, Lounge Chair, Side Chair, Bar & Counter Chair without upholstery and EU/US versions upholstered with a large selection of Kvadrat textiles ² is Global GreenTag Green-Rate Level C-certified. <i>Please note: The Global GreenTag Label only applies for contract market orders with a minimum 5-year warranty.</i>
	¹ Upholstered Muuto products that have the Declare Living Building Challenge Red List Approved certification only have the certification when upholstered with the following Kvadrat textiles: Balder, Canvas, Clara, Clay, Divina, Divina MD, Divina mélange, Fiord, Hallingdal, Hero, Remix, Re-wool, Steelcut, Steelcut Trio, Vidar, Twill weave.
	² Upholstered EU/US versions of Cover Armchair, Cover Lounge Chair and Cover Side Chair only have the GreenTag certificate when upholstered with the following Kvadrat textiles: Canvas, Clara, Divina, Divina MD, Divina melange, Fiord, Hallingdal, Hero, Remix, Re-wool, Steelcut, Steelcut trio, Twill Weave, Vidar.

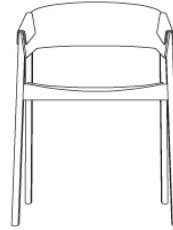

56,2 cm / 22.1"



49,8 cm / 19.6"

75,8 cm / 29.8"
SH 46 cm / 18.1"
Armrest H 65,6 cm / 25.8"

Shipper Colli	1
Gross Weight (kg)	6.9
Net Weight (kg)	5
Base color options	Black, Dark Beige, Green, Oak or Stained Dark Brown
Warranty Period	10 years

Pattern No.	Color	Contract Price	Lead Time
Ready-To-Ship US Warehouse			
MCVRAW-BLCK	Black	USD 667.00	-
MCVRAW-DKBE	Dark Beige	USD 667.00	-
MCVRAW-OAK	Oak	USD 667.00	-
MCVRAW-STDB	Stained Dark Brown	USD 667.00	-
MCVRAU-BLCK-M136BLCK	Refine Leather Black/Black	USD 933.00	-
MCVRAU-OAK-M136COGN	Refine Leather Cognac/Oak	USD 933.00	-
MCVRAU-DKBE-M136STON	Refine Leather Stone/Dark Beige ***	USD 933.00	-

Ready-To-Ship EU Warehouse

MCVRAW-GREN	Green	USD 667.00	-
-------------	-------	------------	---

Extras

MGLDCVSFT4	Felt Glides for the Cover Series (4 pcs per pack) - White	USD 21.00	-
MGLDCVSPT4	Plastic glides for the Cover Series (4 pcs per pack) - White	USD 21.00	-
MLEAKIT	Leather care set for Refine Leather	USD 27.00	-

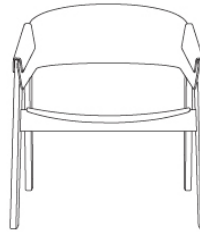

66,3 cm / 26.1"

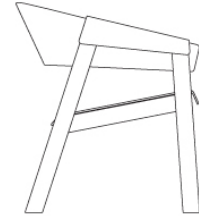

61,2 cm / 24.1"

70,7 cm / 27.8"
SH 38,1 cm / 15"

Shipper Colli	1
Gross Weight (kg)	9.423
Net Weight (kg)	7.5
Base color options	Black, Dark Beige, Oak or Stained Dark Brown
Warranty Period	10 years

Pattern No.	Color	Contract Price	Lead Time
Ready-To-Ship US Warehouse			
MCVRLW-BLCK	Black - PU Lacquer ***	USD 1,206.00	-
MCVRLW-OAK	Oak - PU Lacquer	USD 1,206.00	-
MCVRLW-STDB	Stained Dark Brown	USD 1,206.00	-
MCVRLU-BLCK-M136BLCK	Refine Leather Black/Black	USD 1,675.00	-
MCVRLU-STDB-M136BLCK	Refine Leather Black/Stained Dark Brown	USD 1,675.00	-
MCVRLU-OAK-M136COGN	Refine Leather Cognac/Oak	USD 1,675.00	-
Extras			
MGLDCVSFT4	Felt Glides for the Cover Series (4 pcs per pack) - White	USD 21.00	-
MGLDCVSP4	Plastic glides for the Cover Series (4 pcs per pack) - White	USD 21.00	-
MLEAKIT	Leather care set for Refine Leather	USD 27.00	-

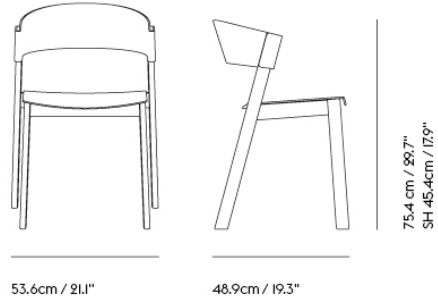

Shipper Colli	1
Gross Weight (kg)	10.3
Net Weight (kg)	4.2
Base color options	Black, Dark Beige, Green, Oak or Stained Dark Brown
Stacking information	Cover Side Chair stacks up to 4 chairs on floor and 10 chairs on the Cover Transport Trolley.
Warranty Period	10 years

Pattern No.	Color	Contract Price	Lead Time
Ready-To-Ship US Warehouse			
MCVRSW-BLCK	Black	USD 667.00	-
MCVRSW-DKBE	Dark Beige	USD 667.00	-
MCVRSW-OAK	Oak	USD 667.00	-
MCVRSW-STDB	Stained Dark Brown	USD 667.00	-
MCVRSU-BLCK-M136BLCK	Refine Leather Black/Black	USD 933.00	-
MCVRSU-STDB-M136BLCK	Refine Leather Black/Stained Dark Brown	USD 933.00	-
MCVRSU-OAK-M136COGN	Refine Leather Cognac/Oak	USD 933.00	-
MCVRSU-DKBE-M136STON	Refine Leather Stone/Dark Beige	USD 933.00	-
Ready-To-Ship EU Warehouse			
MCVRSW-GREN	Green	USD 667.00	-
Extras			
MGLDCVSFT4	Felt Glides for the Cover Series (4 pcs per pack) - White	USD 21.00	-
MGLDCVSPT4	Plastic glides for the Cover Series (4 pcs per pack) - White	USD 21.00	-
MLEAKIT	Leather care set for Refine Leather	USD 27.00	-

COVER AND VISU CHAIR TRANSPORT TROLLEY

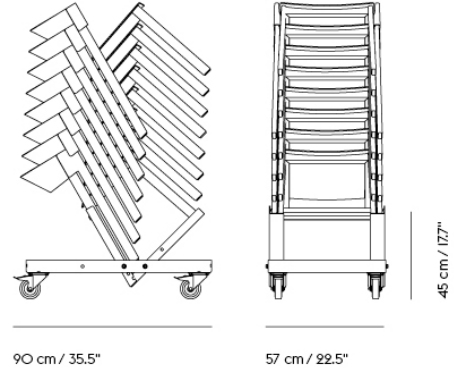

Shipper Colli	1
Gross Weight (kg)	22
Net Weight (kg)	21.5
Please note	This transport trolley can be used for Visu Chair Tube Base, Visu Chair Sled Base and Cover Side Chair.
Stacking information	Stacking on Trolley: Without upholstery: 17. With upholstery: 15. With linking device: 15 Stacking on floor: Without upholstery: 15. With upholstery: 10. With linking device: 8. Cover Side Chair: 4 on floor and 10 on trolley.
Warranty Period	5 years

Pattern No.	Color	Contract Price	Lead Time
Ready-To-Ship US Warehouse			
MTTCV	Black	USD 971.00	-

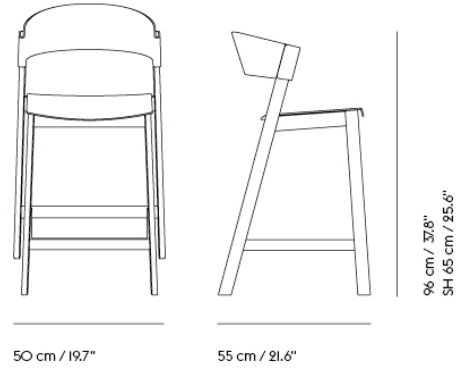

Shipper Colli	1
Gross Weight (kg)	8.75
Net Weight (kg)	5.85
Base color options	Black, Dark Beige, Green, Oak or Stained Dark Brown
Warranty Period	10 Years

Pattern No.	Color	Contract Price	Lead Time
Ready-To-Ship US Warehouse			
MCVRSTCW-BLCK	Black	USD 902.00	-
MCVRSTCW-DKBE	Dark Beige	USD 902.00	-
MCVRSTCW-OAK	Oak	USD 902.00	-
MCVRSTCW-STDB	Stained Dark Brown	USD 902.00	-
MCVRSTCU-BLCK-M136BLCK	Refine Leather Black/Black	USD 1,206.00	-
MCVRSTCU-STDB-M136BLCK	Refine Leather Black/Stained Dark Brown	USD 1,206.00	-
MCVRSTCU-OAK-M136COGN	Refine Leather Cognac/Oak	USD 1,206.00	-
Ready-To-Ship EU Warehouse			
MCVRSTCW-GREN	Green	USD 902.00	-
MCVRSTCW-MBLU	Midnight Blue ***	USD 902.00	-
Extras			
MGLDCVSFT4	Felt Glides for the Cover Series (4 pcs per pack) - White	USD 21.00	-
MGLDCVSPT4	Plastic glides for the Cover Series (4 pcs per pack) - White	USD 21.00	-
MLEAKIT	Leather care set for Refine Leather	USD 27.00	-
MFTRSTC	Steel Footrest Protector - Self-Mounting	USD 39.00	-

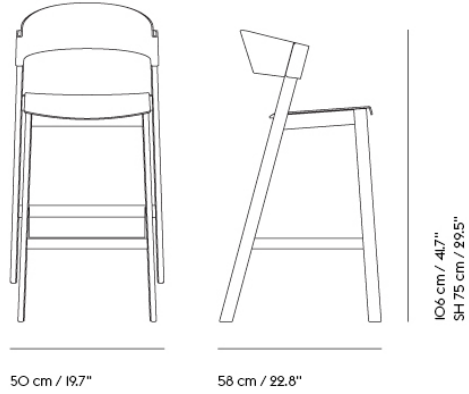

Shipper Colli	1
Gross Weight (kg)	9.15
Net Weight (kg)	6.25
Base color options	Black, Dark Beige, Green, Oak or Stained Dark Brown
Warranty Period	10 Years

Pattern No.	Color	Contract Price	Lead Time
Ready-To-Ship US Warehouse			
MCVRSTBW-BLCK	Black	USD 902.00	-
MCVRSTBW-DKBE	Dark Beige	USD 902.00	-
MCVRSTBW-OAK	Oak	USD 902.00	-
MCVRSTBW-STDB	Stained Dark Brown	USD 902.00	-
MCVRSTBU-BLCK-M136BLCK	Refine Leather Black/Black	USD 1,206.00	-
MCVRSTBU-OAK-M136COGN	Refine Leather Cognac/Oak	USD 1,206.00	-
Ready-To-Ship EU Warehouse			
MCVRSTBW-GREN	Green	USD 902.00	-
Extras			
MGLDCVSFT4	Felt Glides for the Cover Series (4 pcs per pack) - White	USD 21.00	-
MGLDCVSPT4	Plastic glides for the Cover Series (4 pcs per pack) - White	USD 21.00	-
MLEAKIT	Leather care set for Refine Leather	USD 27.00	-
MFTRSTC	Steel Footrest Protector - Self-Mounting	USD 39.00	-

COVER CHAIR SERIES



All Variants

	Description	Pattern No.	Wood Seat	Contract Price								
				Upholstery Grades								
				COM			CIL			COL		
			A	B	C	E	R	T	U	V	W	
Cover Armchair	Wood Seat	M-CVRA-W	667									
	Upholstered Seat	M-CVRA-U		803	845	866	898	866	933	971	1,034	1,101
Cover Side Chair	Wood Seat	M-CVRS-W	667									
	Upholstered Seat	M-CVRS-U		803	845	866	898	929	933	971	1,034	1,101
Cover Lounge Chair	Wood Seat	M-CVRL-W	1,206									
	Upholstered Seat	M-CVRL-U		1,465	1,626	1,675	1,626	1,675	1,675	1,731	1,626	1,836

HOW TO CONFIGURE

ORDER CODE EXAMPLE:

Cover Armchair

Cover Armchair Oak / Steelcut Trio 226

Specify:

- Step 1) Choose variant
- Step 2) Choose wood frame finish option
- Step 3) Choose upholstery
- Step 4) Choose upholstery color

Variant	Cover Armchair Upholstered Seat	MCVRAU
Finish/color	Oak	OAK
Upholstery	Steelcut Trio	M139
Upholstery Color	226	226
Final Pattern No:	MCVRAUOAKM139226	

Wood Frame - Finish Options

- BLCK - Black
- DKBE - Dark Beige
- GREN - Green (only Armchair & Side Chair)
- OAK - Oak
- STDB - Stained Dark Brown

Upholstery Options

A	B	C	E	R	T	U	V	W
Ocean (M161)* Remix (M156)	Canvas (M153) Clara (M154) Colline (M5416) Fiord (M155) Grain (M12659) Manner (M12665) Re-Wool (M4586) Sabi (M8404) Steelcut (M149) SteelCut Trio (M139)	Hallingdal (M146) Illusion (M12654)	Acca (M12660) Beck (M6376) Divina (M150) Divina MD (M147) Divina Melange (M135) Ecriture (M10767) Hearth (M12664) Planum (M5904) Twill Weave (M142) Vidar (M158)	Easy Leather (M141)	Refine Leather (M136)	Endure Leather (M137)	Grace Leather (M12374)	Allure Leather (M12375)

*Notes:
Ocean - Color 3, 21, 32, 50, 52, 80 & 601
Illusion - Black, Blue, Caribou, Chocolate, Ciel,
Dark Green, Dark Caramel, Grey, Light Grey, Mink,
Matrine, Petrol, Stone, Taupe, Tile

COVER STOOL



All Variants

			Contract Price									
			Upholstery Grades									
			COM CIL COL									
			E R T U V W									
Description	Pattern No.	Wood Seat	A	B	C	E	R	T	U	V	W	
Cover Bar Stool	Wood Seat	M-CVRSTB-W	902									
	Upholstered Seat	M-CVRSTB-U		1,024	1,101	1,150	1,150	1,150	1,206	1,255	1,311	1,311
Cover Counter Stool	Wood Seat	M-CVRSTC-W	902									
	Upholstered Seat	M-CVRSTC-U		1,024	1,101	1,150	1,150	1,150	1,206	1,255	1,311	1,311
Cover Bar Stool w. footrest	Wood Seat	M-CVRSTB-WF	933									
	Upholstered Seat	M-CVRSTB-UF		1,101	1,150	1,150	1,206	1,206	1,255	1,255	1,360	1,360
Cover Counter Stool w. footrest	Wood Seat	M-CVRSTC-WF	933									
	Upholstered Seat	M-CVRSTC-UF		1,101	1,150	1,150	1,206	1,206	1,255	1,255	1,360	1,360

HOW TO CONFIGURE

ORDER CODE EXAMPLE:

Cover Counter Stool

Cover Counter Stool Oak / Steelcut Trio 226

Specify:

- Step 1) Choose variant
- Step 2) Choose wood frame finish option
- Step 3) Choose upholstery
- Step 4) Choose upholstery color

Variant	Cover Counter Stool Upholstered Seat	M-CVRSTCU
Finish/color	Oak	OAK
Upholstery	Steelcut Trio	M139
Upholstery Color	226	226
Final Pattern No:	M-CVRSTCUOKM139226	

Wood Frame - Finish Options

- BLCK - Black
- DKBE - Dark Beige
- GREN - Green (only Armchair & Side Chair)
- OAK - Oak
- STDB - Stained Dark Brown

Upholstery Options

A	B	C	E	R	T	U	V	W
Ocean (M161)* Remix (M156)	Canvas (M153) Clara (M154) Colline (M5416) Fiord (M155) Grain (M12659) Manner (M12665) Re-Wool (M4586) Sabi (M8404) Steelcut (M149) SteelCut Trio (M139)	Hallingdal (M146) Illusion (M12654)	Acca (M12660) Beck (M6376) Divina (M150) Divina MD (M147) Divina Melange (M135) Ecriture (M10767) Hearth (M12664) Planum (M5904) Twill Weave (M142) Vidar (M158)	Easy Leather (M141)	Refine Leather (M136)	Endure Leather (M137)	Grace Leather (M12374)	Allure Leather (M12375)

*Notes:
Ocean - Color 3, 21, 32, 50, 52, 80 & 601
Illusion - Black, Blue, Caribou, Chocolate, Ciel,
Dark Green, Dark Caramel, Grey, Light Grey, Mink,
Matrine, Petrol, Stone, Taupe, Tile

DOZE LOUNGE CHAIR & OTTOMAN

"Scandinavia has a long tradition of extensively comfortable lounge chairs; at the heart of our design heritage lies the versatile concept of comfort. As such, the idea of creating a grand lounge chair came very natural to us. The visual references of the Doze Lounge Chair are however derived from the modern and clear lines of the Golden Age in Danish design, while at the same time being informed by some of our favorite designs of the 1970's. To us, the characteristically large and sheltering back that embraces the soft seat creates a combination of the Scandinavian design ethos and the lines of 1970's objects in a way that we find truly refreshing"

— Anderssen & Voll

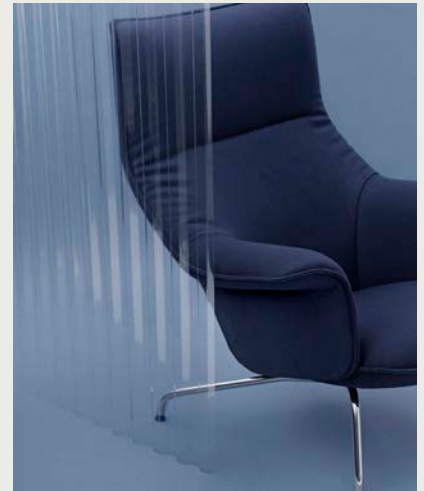

Designed by	Anderssen & Voll
Environment	Indoor
Country of Production	Poland
Assembly Required	No
Description	<p>Designed with extensive comfort and a modern expression through the vibrant lines and folds of its back and armrests along with an embracing seat, the Doze Lounge Chair High Back joins together the ideas of Scandinavian design with the lines' of 1970's furniture for a contemporary perspective on the archetypal lounge chair. Use the Doze Lounge Chair High Back on its own or with the Doze Ottoman.</p> <p>The Doze Lounge Chair Low Back is a natural line extension to the existing Doze Lounge Chair High Back. The Doze Lounge Chair Low Back embodies a sleek, modern expression and soft comfort, just like its larger counterpart, while presenting a smaller footprint that seamlessly integrates into various lounge areas. This scaled-down version allows for more versatile placement, making it ideal for placing multiple chairs in the same space.</p>
Material	<p>The Doze Lounge Chair & Ottoman are made from metal, foam, and wadding and finished with textile, imitation leather, or leather upholstery. The leather comes from selected premium leather suppliers.</p> <p>The Doze Lounge Chair & Ottoman are upholstered in molded foam with an embedded steel frame. Please note that the Doze Lounge Chair & Ottoman's upholstery cannot be removed. Swivel base in polished or powder-coated casted aluminum. Tube base in chromed or powder-coated steel. Plastic glides in black.</p>
Cleaning & Care	<p>For textile upholstered versions: In case of stains, we generally recommend removing non-greasy stains by carefully dabbing them with a lint-free cloth or sponge wrung out in clean, warm water. Clean by dabbing with soapy water made with a bit of dish soap if necessary. Finally, dab the surface with clean water. We advise visiting Kvadrat.dk, Nevotex.dk, Maharam.com, or Gabriel.dk for further cleaning and maintenance instructions for your chosen textile, as the cleaning methods may vary.</p> <p>Imitation Leather: Clean with lukewarm PH-neutral, soapy water and a soft cloth or soft brush. Do not use solvents or chemical cleaners, but cleaning can be done with alcohol-based cleaners. Finally, wipe with a damp cloth afterward.</p> <p>Leather: As a natural material, leather requires looking after. If you care for the leather correctly, it will become even more beautiful over time.</p> <p>Refine Leather, Easy Leather, and Endure Leather: Regularly clean leather with a dry cloth. Treat the leather at least four times a year using only special leather treatment products. Visit ca-mo.com for further information on cleaning leather.</p>

Allure and Grace Leather: Only vacuum clean with a soft brush. Never use soap or water; otherwise, the velvety look and feel will disappear. Do not apply leather grease or soak the leather. Avoid chemical products like saddle soap, leather cleaners, or household products.

Base: Clean with a moist cloth. If necessary, use a little dish soap on the cloth.

Spare Parts

Pre-mounted plastic glides included. Felt and plastic glides can be purchased separately

Lounge Chair High Back
Lounge Chair Low Back
Ottoman

CUSTOMIZED UPHOLSTERY

Textile upholstery: 4,8 m / 5.3 yds — Leather upholstery: 6,5 m² / 70 ft²

Textile upholstery: 3,5 m / 3.9 yds — Leather upholstery: 6 m² / 64.6 ft²

Textile upholstery: 1,1 m / 1.2 yds — Leather upholstery: 2 m² / 21.5 ft²

EN 16139:2013 - L2

TESTS & CERTIFICATIONS

Furniture - Strength, durability and safety.
Requirements for non-domestic seating.

ANSI/BIFMA X5.4-2020

American National Standard For Office Furnishings.
Lounge and Public Seating.

EN 1022:2005

Domestic Seating - Determination of stability.

VOC CDPH 01350 &
VOC BIFMA X7.1.

Doze Lounge Chair and Ottoman in EU/US versions upholstered with Easy or Refine Leather and a large selection of Kvadrat textiles¹ are tested to VOC CDPH 01350 and VOC BIFMA X7.1.

¹Upholstered Muuto products that are tested to VOC CDPH 01350 and VOC BIFMA X7.1 are only compliant when upholstered with the following Kvadrat textiles: Balder, Canvas, Clara, Clay, Divina, Divina MD, Divina mélange, Fiord, Hallingdal, Hero, Ocean, Remix, Re-wool, Steelcut, Steelcut Trio, Vidar, Twill weave.

DOZE LOUNGE CHAIR HIGH BACK TUBE BASE

108

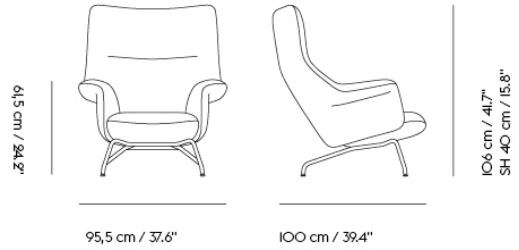

Shipper Colli	1
Gross Weight (kg)	45
Net Weight (kg)	40
Base color options	Anthracite Black, Chrome, Grey
Warranty Period	10 years

Pattern No.	Color	Contract Price	Lead Time
Ready-To-Ship US Warehouse			
MDOZLC-BLCK-M16180	Ocean 80/Anthracite Black	USD 3,096.00	-
MDOZLC-CHRO-M152782	Balder 782/Chrome	USD 3,775.00	-
MDOZLC-BLCK-M136COGN	Refine Leather Cognac/Anthracite Black	USD 4,615.00	-
Ready-To-Ship EU Warehouse			
MDOZLC-CHRO-M4586128	Re-Wool 128/Chrome	USD 3,411.00	-
Extras			
MGLDDLOFB4	Felt Glides for Doze Lounge Chair and Ottoman (4 pcs per pack)	USD 21.00	-
MLEAKIT	Leather care set for Refine Leather	USD 27.00	-

DOZE LOUNGE CHAIR HIGH BACK SWIVEL BASE

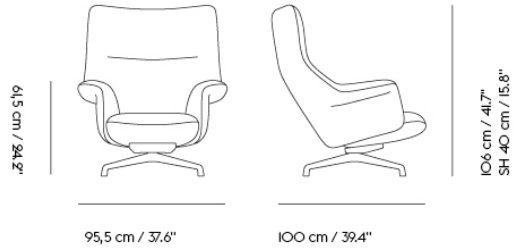

Shipper Colli	1
Gross Weight (kg)	45
Net Weight (kg)	40
Base color options	Anthracite Black, Grey or Polished Aluminum
Warranty Period	10 years

Pattern No.	Color	Contract Price	Lead Time
Ready-To-Ship US Warehouse			
MDOZLC-BLCK-M16180	Ocean 80/Anthracite Black	USD 3,411.00	-
MDOZLC-BLCK-M136COGN	Refine Leather Cognac/Anthracite Black	USD 4,881.00	-
Extras			
MGLDDLOFB4	Felt Glides for Doze Lounge Chair and Ottoman (4 pcs per pack)	USD 21.00	-
MLEAKIT	Leather care set for Refine Leather	USD 27.00	-

DOZE OTTOMAN TUBE BASE

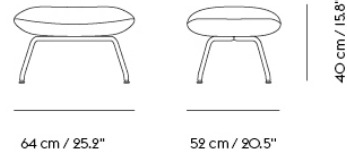
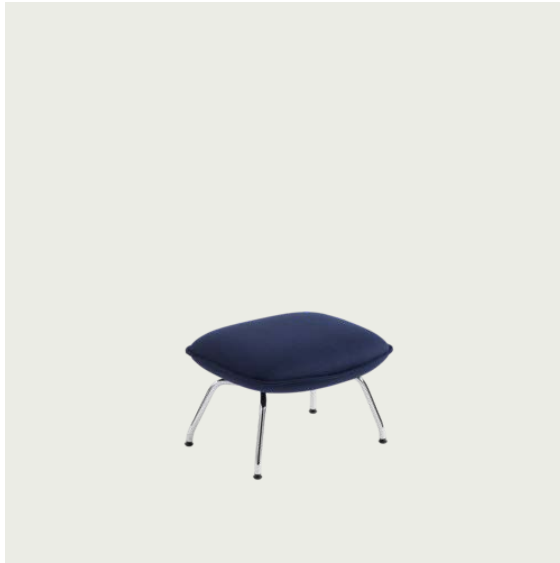

Shipper Colli	1
Gross Weight (kg)	20
Net Weight (kg)	18
Base color options	Anthracite Black, Chrome, Grey
Warranty Period	10 years

Pattern No.	Color	Contract Price	Lead Time
Ready-To-Ship US Warehouse			
MDOZOTT-BLCK-M16180	Ocean 80/Anthracite Black	USD 1,028.00	-
MDOZOTT-CHRO-M152782	Balder 782/Chrome	USD 1,311.00	-
MDOZOTT-BLCK-M136COGN	Refine Leather Cognac/Anthracite Black	USD 1,465.00	-
Ready-To-Ship EU Warehouse			
MDOZOTT-CHRO-M4586128	Re-Wool 128/Chrome	USD 1,150.00	-
Extras			
MGLDDLOFB4	Felt Glides for Doze Lounge Chair and Ottoman (4 pcs per pack)	USD 21.00	-
MLEAKIT	Leather care set for Refine Leather	USD 27.00	-

DOZE OTTOMAN SWIVEL BASE

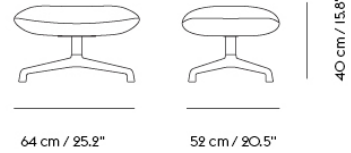

Shipper Colli	1
Gross Weight (kg)	20
Net Weight (kg)	18
Base color options	Anthracite Black, Grey or Polished Aluminum
Warranty Period	10 years

Pattern No.	Color	Contract Price	Lead Time
Ready-To-Ship US Warehouse			
MDOZOTTSWB-BLCK-M16180	Ocean 80/Anthracite Black	USD 1,311.00	-
MDOZOTTSWB-BLCK-M136COGN	Refine Leather Cognac/Anthracite Black	USD 1,731.00	-
Extras			
MGLDDLOFB4	Felt Glides for Doze Lounge Chair and Ottoman (4 pcs per pack)	USD 21.00	-
MLEAKIT	Leather care set for Refine Leather	USD 27.00	-

DOZE LOUNGE CHAIR & OTTOMAN



All Variants

		Contract Price								
		Upholstery Grades								
		A	COM	CIL	E	R	COL	U	V	W
Pattern No.			B	C			T			
Doze Lounge Chair Tube Base	M-DOZLC	3,096	3,411	3,565	3,775	4,300	4,615	4,986	5,826	5,980
Doze Lounge Chair Swivel Base	M-DOZLCSWB	3,411	3,621	3,831	4,090	4,405	4,881	5,511	6,085	6,246
Doze Ottoman Tube Base	M-DOZOTT	1,028	1,150	1,255	1,311	1,416	1,465	1,731	1,836	1,885
Doze Ottoman Swivel Base	M-DOZOTTSWB	1,311	1,416	1,570	1,626	1,570	1,731	1,941	2,095	2,151

HOW TO CONFIGURE

Doze Lounge Specify:
 Step 1) Choose variant
 Step 2) Choose base color
 Step 3) Choose upholstery
 Step 4) Choose upholstery color

ORDER CODE EXAMPLE

Doze Lounge Chair in Ocean 80 w/anthracite black base

Variant	Doze Lounge	MDOZLC
Base Color	Anthracite Black	BLCK
Upholstery	Ocean	M161
Upholstery Color	80	80
Final Pattern No:	MDOZLCBLCKM16180	

Frame - Finish Options

BLCK - Anthracite Black
 CHRO - Chrome
 ALU - Polished Aluminum (Only available on Swivel Base)

Upholstery Options

A	B	C	E	R	T	U	V	W
Ocean (M161)*	Clara (M154) Colline (M5416) Fiord (M155) Grain (M12659) Manner (M12665) Re-Wool (M4586) Sabi (M8404) Steelcut (M149) Steelcut Trio (M139)	Hallingdal (M146) Illusion (M12654)	Acca (M12660) Balder (M152) Beck (M6376) Divina (M150) Divina MD (M147) Divina Melange (M135) Ecriture (M10767) Hearth (M12664) Planum (M5904) Twill Weave (M142) Vidar (M158)	Easy Leather (M141)	Refine Leather (M136)	Endure Leather (M137)	Grace Leather (M12374)	Allure Leather (M12375)

*Notes:
 Ocean - Color 3, 21, 32, 50, 52, 80 & 601
 Illusion - Black, Blue, Caribou, Chocolate, Ciel, Dark Green, Dark Caramel, Grey, Light Grey, Mink, Matrine, Petrol, Stone, Taupe, Tile

ECHO POUF

"Inspired by the idea of repetitions, the Echo Pouf has a simple and elegant expression through its modern lines and soft seat, allowing for the design to be repeated throughout any space to create visual echoes of its form."

— Anderssen & Voll



Designed by	Anderssen & Voll
Environment	Indoor
Country of Production	Lithuania
Assembly Required	No
Description	The Echo Pouf has a simple, friendly expression that brings comfort and function to any space alongside its light and almost hovering expression through its small legs underneath. The name of the Echo Pouf refers to how the design can be used in symmetric formations or clusters with various sizes and upholsteries, creating visual echoes throughout the space.
Material	The Echo Pouf is made from a wooden frame, High-Resilience foam, and textile or imitation leather upholstery.
Cleaning & Care	<p>For textile upholstered versions: In case of stains, we generally recommend removing non-greasy stains by carefully dabbing with a lint-free cloth or sponge wrung out in clean, warm water. If necessary, clean by dabbing with soapy water made with a little dish soap. Finally, dab the surface with clean water. We highly recommend that you go to kvadrat.dk for further cleaning and maintenance instructions for your chosen textile, as the cleaning methods may vary from one textile to another.</p> <p>Imitation Leather: Clean with lukewarm PH-neutral, soapy water and a soft cloth or soft brush. Do not use solvents or chemical cleaners, but cleaning can be done with alcohol-based cleaners. Finally, wipe with a damp cloth afterward.</p>
	<p>CUSTOMIZED UPHOLSTERY</p> <p>Textile upholstery: 1,6 m / 1.78 yds Textile upholstery: 1,47 m / 1.61 yds Textile upholstery: 1,65 m / 1.81 yds</p>
	<p>TESTS & CERTIFICATIONS</p> <p>EN 16139:2013 - L2 Extreme use Furniture - Strength, durability and safety. Requirements for non-domestic seating.</p> <p>EN 1022:2005 Extreme use Domestic furniture - Seating - Determination of stability.</p> <p>ANSI/BIFMA X5.4-2012 American National Standard For Office Furnishings.</p> <p>VOC CDPH 01350 & VOC BIFMA X7.1. Echo Pouf in EU/US versions upholstered with a large selection of Kvadrat textiles¹ are tested to VOC CDPH 01350 and VOC BIFMA X7.1.</p>

¹Upholstered Muuto products that are tested to VOC CDPH 01350 and VOC BIFMA X7.1. are only compliant when upholstered with the following Kvadrat textiles: Balder, Canvas, Clara, Clay, Divina, Divina MD, Divina mélange, Fiord, Hallingdal, Hero, Remix, Re-wool, Steelcut, Steelcut Trio, Vidar, Twill weave.

ECHO POUF / 38 X 52 CM / 15 X 20.5"

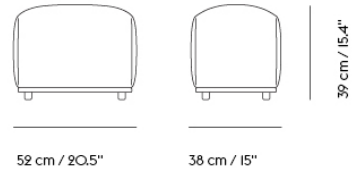

Shipper Colli 1
Gross Weight (kg) 15
Net Weight (kg) 9
Warranty Period 10 years

Pattern No.	Color	Contract Price	Lead Time
Ready-To-Ship US Warehouse			
MECHOP1521-K23401	Attire 1/Black	USD 954.00	-
MECHOP1521-K23406	Attire 6/Black	USD 954.00	-

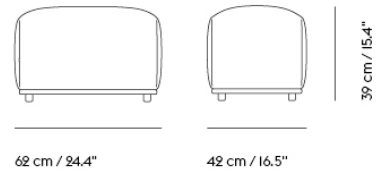

Shipper Colli I
 Gross Weight (kg) 17
 Net Weight (kg) 11
 Warranty Period 10 years

Pattern No.	Color	Contract Price	Lead Time
Ready-To-Ship US Warehouse			
MECHOP1725-K23401	Attire 1/Black	USD 1,024.00	-
MECHOP1725-K23406	Attire 6/Black	USD 1,024.00	-

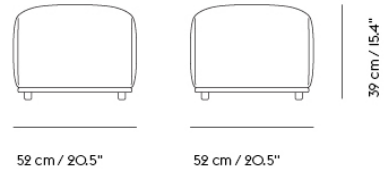

Shipper Colli 1
 Gross Weight (kg) 18
 Net Weight (kg) 12
 Warranty Period 10 years

Pattern No.	Color	Contract Price	Lead Time
Ready-To-Ship US Warehouse			
MECHOP2121-M156163	Remix I63 ***	USD 828.00	-
MECHOP2121-K23401	Attire I/Black	USD 992.00	-

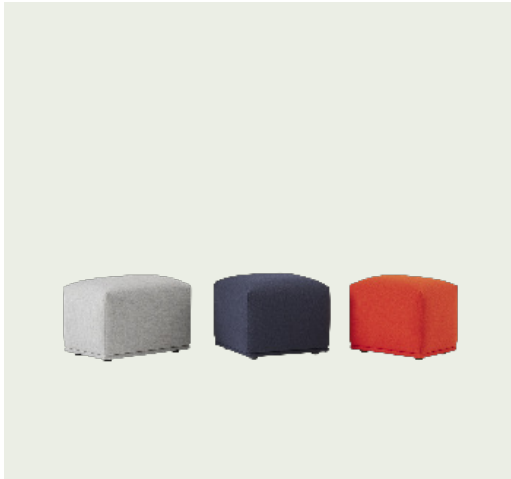

All Variants

		Contract Price			
		Upholstery Grades			
		COM			
Size	Pattern No.	A	B	C	E
38 X 52 CM / 15" x 20.5"	M-ECHOP-1521	755	954	1,013	1,024
42 X 62 CM / 16.5" x 24.4"	M-ECHOP-1725	919	1,024	1,101	1,150
52 X 52 CM / 20.5" x 20.5"	M-ECHOP-2121	828	992	1,024	1,045

HOW TO CONFIGURE

Echo pouf
Specify:
Step 1) Choose Size"
Step 2) Choose textile
Step 3) Choose textile color

ORDER CODE EXAMPLE

Echo pouf 15 x 20.5" in Ocean 80

Size 15 x 20.5"
Textile Ocean
Textile Color 80
Final Pattern No: MECHOP1521M16180

MECHOP1521
M161
80

Upholstery Options

A	B	C	E
Ocean (M161)* Remix (M156)	Cameo (K1443) Canvas (M153) Clara (M154) Colline (M5416) Fiord (M155) Grain (M12659) Manner (M12665) Steelcut (M149) Steelcut Trio (M139)	Hallingdal (M146) Illusion (M12654)	Acca (M12660) Aegean (K2074) Beck (M6376) Clay (M2449)* Divina (M150) Divina MD (M147) Divina Melange (M135) Ecriture (M10767) Hearth (M12664) Highland (K2010) Planum (M5904) Twill Weave (M142) Vidar (M158)

***Notes:**

Ocean - Color 3, 21, 32, 50, 52, 80 & 601

Clay - Color 1, 2, 3, 4, 5, 6, 7, 8, 9, 10, 11, 12, 13, 14, 15, 16 & 17

Illusion - Black, Blue, Caribou, Chocolate, Ciel, Dark Green, Dark Caramel, Grey, Light Grey, Mink, Matrine, Petrol, Stone, Taupe, Tile

ENFOLD SIDEBOARD

"Enfold Sideboard came from the many factory visits that I do as a designer, prompting me to explore the aesthetic appeal of industrial objects. I wanted to translate this element into the modern home, combined with an appreciation of the Scandinavian design tradition. The Enfold Sideboard joins a warm touch of oak with a contemporary look of its ridged front, softening up the cold steel material and binding it together with the sideboard's oak components. The design is a new perspective on the traditional sideboard with an at once industrial and homey feeling, characterized by its unique duality of materials."

— Thomas Bentzen



Designed by	Thomas Bentzen
Environment	Indoor
Country of Production	Sweden
Assembly Required	Yes
Description	The Enfold Sideboard combines industrial materiality with residential references for a new perspective on modern storage. Made from a lacquered steel that gently enfolds its top and bottom in solid oak, the Enfold Sideboard fuses cold and warm materials for a unique expression, paired with the vibrantly modern expression of its ridged steel doors. The flexible design is available in four sizes, which all have adjustable shelves and discreet cable outlets. This offers the opportunity to find just the right fit for your space, function and needs — be it a media console, in the hallway or a tall sideboard for storage.
Material	Body, shelves and sliding doors in powder-coated bent steel. Top and base in solid oak treated with a clear oil (Size 186 x 45 H:48 cm and 148 x 45 H:85 cm as well as all sizes in Oak / Deep Red) or matte clear lacquer for other variants. Adjustable feet. Size 186 x 45 H:48 cm and 148 x 45 H:85 cm as well as all sizes in Oak / Deep Red are FSC™-certified (FSC-CO28824).
Cleaning & Care	Powder-coated steel: Wipe off with moist cloth and remove excess liquid with dry cloth. Solid Oak: Upon receiving your product, we recommend that top and bottom boards are treated with special oak wood oil, improving its resistance to stains and fluids. We also recommend that you continue caring for the product by repeating this treatment 2-3 times a year. Avoid placing the sideboard in the immediate distance of a heat source. Do not place hot or wet objects directly on the sideboard, as they can leave a mark on the top. Metal objects can leave a mark if left on the sideboard for a longer period of time. Clean the top often and carefully with a soft and dry cloth following the wood's grain patterns. The product should not be exposed to excessive humidity, heat, or direct sunlight.
ANSI/BIFMA X5.9-2019	TESTS & CERTIFICATIONS American National Standard For Office Furnishings – Storage Units.
EN 16121:2013+ A1:2017 - L2	Extreme use. Non-domestic storage furniture. Requirements for safety, strength, durability and stability.
Forest Stewardship Council™	Size 186 x 45 H:48 cm and 148 x 45 H:85 cm as well as all sizes in Oak / Deep Red are made using FSC™-certified (FSC-CO28824) wood.

ENFOLD SIDEBORD / 100 X 45 H: 85 CM / 39 X 17.7 H: 33.2"

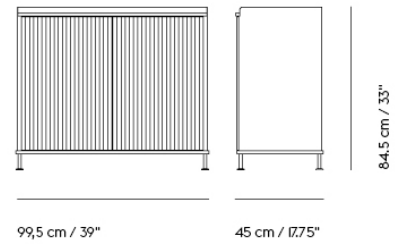

Shipper Colli	1
Gross Weight (kg)	54.16
Net Weight (kg)	41
Please note	This product includes 2 shelves. Up to 4 additional shelves can be added.
Warranty Period	10 years

Pattern No.	Color	Contract Price	Lead Time
Ready-To-Ship US Warehouse			
MENFSBT-BLCK-BLCK	Black/Anthracite Black	USD 2,676.00	-
MENFSBT-OAK-DGRN	Lacquered Oak/Dusty Green	USD 2,676.00	-
MENFSBT-OAK-GREY	Lacquered Oak/Grey	USD 2,676.00	-
MENFSBT-OAK-DPRD	Oiled Oak/Deep Red	USD 2,676.00	-
Ready-To-Ship EU Warehouse			
MENFSBT-OAK-BLCK	Lacquered Oak/Anthracite Black	USD 2,676.00	-
Extras			
MENFSBTES-BLCK	Extra shelf - 100 x 45 H: 85 CM / 39 x 17.7 H: 33.2" and 148 x 45 H: 85 CM / 58 x 17.7 H: 33.2" - Anthracite Black	USD 257.00	-
MENFSBTES-DPRD	Extra shelf - 100 x 45 H: 85 CM / 39 x 17.7 H: 33.2" and 148 x 45 H: 85 CM / 58 x 17.7 H: 33.2" - Deep Red	USD 257.00	-
MENFSBTES-DGRN	Extra shelf - 100 x 45 H: 85 CM / 39 x 17.7 H: 33.2" and 148 x 45 H: 85 CM / 58 x 17.7 H: 33.2" - Dusty Green	USD 257.00	-

ENFOLD SIDEBORD / 124 X 45 H: 63 CM / 49 X 17.7 H: 24.6"

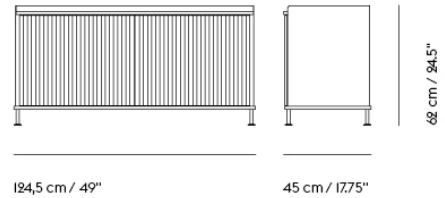
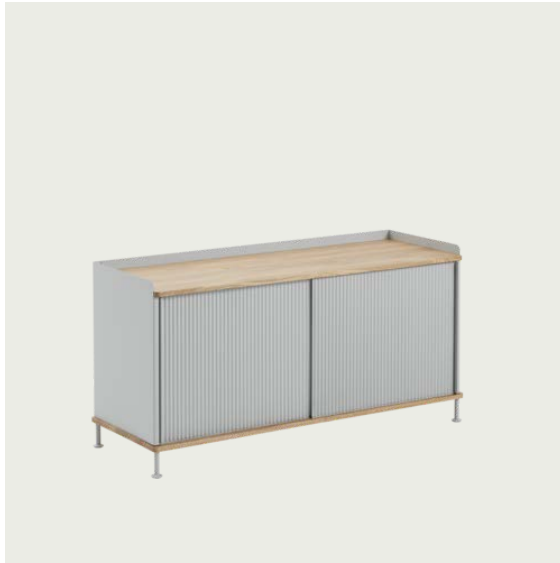

Shipper Colli	1
Gross Weight (kg)	42.54
Net Weight (kg)	38
Please note	This product includes 2 shelves. Up to 4 additional shelves can be added.
Warranty Period	10 years

Pattern No.	Color	Contract Price	Lead Time
Ready-To-Ship US Warehouse			
MENFSBL-BLCK-BLCK	Black/Anthracite Black	USD 2,676.00	-
MENFSBL-BLCK-BLCK	Black/Anthracite Black	USD 2,676.00	-
MENFSBL-OAK-DGRN	Lacquered Oak/Dusty Green ***	USD 2,676.00	-
MENFSBL-OAK-GREY	Lacquered Oak/Grey	USD 2,676.00	-
MENFSBL-OAK-DPRD	Oiled Oak/Deep Red	USD 2,676.00	-
Ready-To-Ship EU Warehouse			
MENFSBL-OAK-BLCK	Lacquered Oak/Anthracite Black	USD 2,676.00	-
Extras			
MENFSBLES-BLCK	Extra shelf - 124 x 45 H: 63 CM / 49 x 17.7 H: 24.6" and 186 x 45 H: 48 CM / 73 x 17.7 H: 18.9" - Anthracite Black	USD 257.00	-
MENFSBLES-DPRD	Extra shelf - 124 x 45 H: 63 CM / 49 x 17.7 H: 24.6" and 186 x 45 H: 48 CM / 73 x 17.7 H: 18.9" - Deep Red	USD 257.00	-
MENFSBLES-DGRN	Extra shelf - 124 x 45 H: 63 CM / 49 x 17.7 H: 24.6" and 186 x 45 H: 48 CM / 73 x 17.7 H: 18.9" - Dusty Green	USD 257.00	-
MENFSBLES-GREY	Extra shelf - 124 x 45 H: 63 CM / 49 x 17.7 H: 24.6" and 186 x 45 H: 48 CM / 73 x 17.7 H: 18.9" - Grey	USD 257.00	-

ENFOLD SIDEBOARD / 148 X 45 H: 85 CM / 58 X 17.7 H: 33.2"

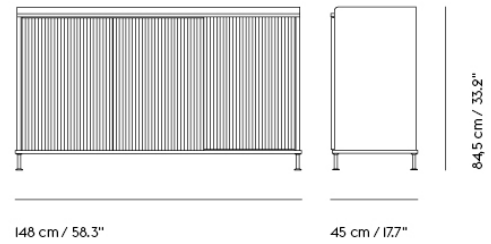

Shipper Colli	1
Gross Weight (kg)	67.55
Net Weight (kg)	52.25
Please note	This product includes 3 shelves. Up to 6 additional shelves can be added.
Warranty Period	10 years

Pattern No.	Color	Contract Price	Lead Time
Ready-To-Ship US Warehouse			
MENFSBTW-BLCK-BLCK	Black/Anthracite Black	USD 3,936.00	-
MENFSBTW-OAK-DPRD	Oiled Oak/Deep Red	USD 3,936.00	-
MENFSBTW-OAK-DGRN	Oiled Oak/Dusty Green	USD 3,936.00	-
Ready-To-Ship EU Warehouse			
MENFSBTW-OAK-BLCK	Oiled Oak/Anthracite Black	USD 3,936.00	-
MENFSBTW-OAK-GREY	Oiled Oak/Grey	USD 3,936.00	-
Extras			
MENFSBTES-BLCK	Extra shelf - 100 x 45 H: 85 CM / 39 x 17.7 H: 33.2" and 148 x 45 H: 85 CM / 58 x 17.7 H: 33.2" - Anthracite Black	USD 257.00	-
MENFSBTES-DPRD	Extra shelf - 100 x 45 H: 85 CM / 39 x 17.7 H: 33.2" and 148 x 45 H: 85 CM / 58 x 17.7 H: 33.2" - Deep Red	USD 257.00	-
MENFSBTES-DGRN	Extra shelf - 100 x 45 H: 85 CM / 39 x 17.7 H: 33.2" and 148 x 45 H: 85 CM / 58 x 17.7 H: 33.2" - Dusty Green	USD 257.00	-

**ENFOLD SIDEBOARD / 186 X 45 H: 48 CM
/ 73 X 17.7 H: 18.9"**

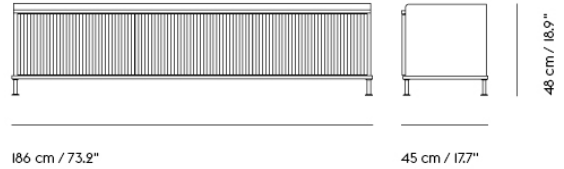
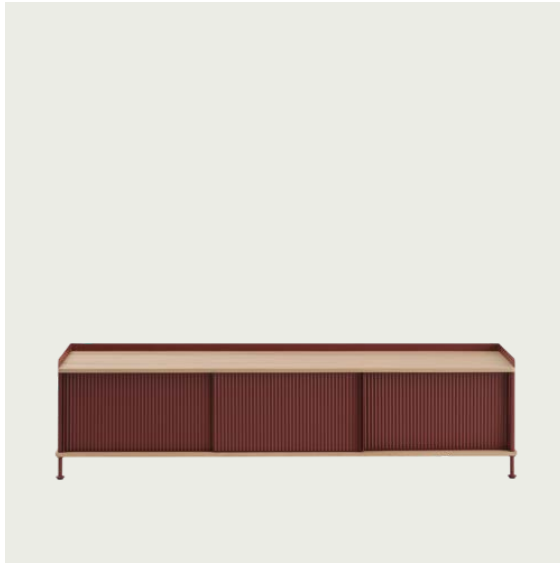

Shipper Colli	1
Gross Weight (kg)	64.74
Net Weight (kg)	48.44
Please note	This product includes 3 shelves. No additional shelves can be added.
Warranty Period	10 years

Pattern No.	Color	Contract Price	Lead Time
Ready-To-Ship US Warehouse			
MENFSBLL-BLCK-BLCK	Black/Anthracite Black	USD 3,936.00	-
MENFSBLL-OAK-DPRD	Oiled Oak/Deep Red	USD 3,936.00	-
MENFSBLL-OAK-DGRN	Oiled Oak/Dusty Green	USD 3,936.00	-
Ready-To-Ship EU Warehouse			
MENFSBLL-OAK-BLCK	Oiled Oak/Anthracite Black	USD 3,936.00	-
MENFSBLL-OAK-GREY	Oiled Oak/Grey	USD 3,936.00	-
Extras			
MENFSBLES-BLCK	Extra shelf - 124 x 45 H: 63 CM / 49 x 17.7 H: 24.6" and 186 x 45 H: 48 CM / 73 x 17.7 H: 18.9" - Anthracite Black	USD 257.00	-
MENFSBLES-DPRD	Extra shelf - 124 x 45 H: 63 CM / 49 x 17.7 H: 24.6" and 186 x 45 H: 48 CM / 73 x 17.7 H: 18.9" - Deep Red	USD 257.00	-
MENFSBLES-DGRN	Extra shelf - 124 x 45 H: 63 CM / 49 x 17.7 H: 24.6" and 186 x 45 H: 48 CM / 73 x 17.7 H: 18.9" - Dusty Green	USD 257.00	-
MENFSBLES-GREY	Extra shelf - 124 x 45 H: 63 CM / 49 x 17.7 H: 24.6" and 186 x 45 H: 48 CM / 73 x 17.7 H: 18.9" - Grey	USD 257.00	-

FIBER CHAIR SERIES

"One of the most difficult and noble disciplines is to design without eccentricity, creating simple, well-functioning and almost ordinary objects that nevertheless have strong identities. We designed the Fiber Chair Family to do just that through a clear sculptural language that refuses to compromise on comfort. It's a chair stripped of all unnecessary layers. The iconic form combines soft, embracing curves with an innovative wood fiber composite, giving the Fiber Chair Family a unique expression and tactile texture."

— Iskos-Berlin



Designed by	Iskos-Berlin
Environment	Indoor
Country of Production	Mexico
Assembly Required	No
Description	The Fiber Chair Series brings a new perspective to the iconic shell chair through its innovative composite of wood fibers and 100% recycled plastic. The wood fibers blend into the surface for a matte finish, adding a soft, inviting touch. The Fiber Chair is designed with friendly, embracing curves that provide extensive comfort to its user while taking up little space in the room.
Material	<p>Shell - Without Upholstery: 100% recycled plastic reinforced with strength-improving additives and mixed with up to 25% FSC™-certified (FSC-CO28824) wood fibers. Due to the partly natural material of the shell, slight color variations can occur.</p> <p>Shell – Upholstered Variants: 100% recycled plastic reinforced with strength-improving additives and mixed with up to 25% wood fibers. Shell can be upholstered with textile, imitation leather, or leather. Leather from selected premium leather suppliers.</p> <p>Shell – Front Upholstered Variants: 100% recycled plastic reinforced with strength-improving additives and mixed with up to 25% wood fibers. Due to the partly natural material of the shell, slight color variations can occur. Shell can be front upholstered with textile, imitation leather or leather. Leather from selected premium leather suppliers.</p> <p>Base: Tube base in powder coated or chromed steel. Wood base in FSC™-certified (FSC-CO28824) oak with water-based lacquer. For Stained Dark Brown version only: Please note that slight color variations can occur due to the inherent characteristics of the material. Plastic glides. Swivel base in powder coated or polished aluminum. Plastic glides. Sled base in powder coated steel. A-base in chromed steel.</p>

Cleaning & Care

Textile: For textile upholstered versions: In case of stains, we generally recommend removing non-greasy stains by carefully dabbing with a lint-free cloth or sponge wrung out in clean warm water. If necessary, clean by dabbing with soapy water made with a little dish soap. Finally, dab the surface with clean water. We highly recommend that you go to kvadrat.dk for further cleaning and maintenance instructions for your chosen textile, as the cleaning methods may vary from one textile to another.

Imitation Leather: Clean with lukewarm PH-neutral soapy water and a soft cloth or soft brush. Do not use solvents or chemical cleaners, but cleaning can be done with alcohol-based cleaners. Finally, wipe with a damp cloth afterwards.

Leather: As a natural material, leather requires looking after. If you care for the leather in the right way, it will become even more beautiful over time.

Refine Leather, Easy Leather and Endure Leather: Clean leather with a dry cloth regularly. treat the leather at least four times a year using only special leather treatment products. Visit ca-mo.com further information on cleaning leather.

Allure and Grace Leather: Only vacuum clean with a soft brush. Never use soap or water otherwise the velvety look and feel will disappear. Do not apply leather grease or soak the leather. Avoid any chemical products, such as saddle soap, leather cleaners or household products.

Base: Clean with a moist cloth. If necessary, use a little dish soap on the cloth.

CUSTOMIZED UPHOLSTERY

Armchair Full Uph.

Textile upholstery: 1,5 m / 1.2 yds — Leather upholstery: 3 m² / 32.3 ft²

Armchair Front Uph.

Textile upholstery: 1,2 m / 1.1 yds — Leather upholstery: 2,2 m² / 23.7 ft²

Side Chair

Textile upholstery: 1,4 m / 1.2 yds — Leather upholstery: 2,2 m² / 23.7 ft²

Lounge Chair

Textile upholstery: 1,8 m / 2 yds — Leather upholstery: 3,3 m² / 35.5 ft²

Bar & Counter Stool

Textile upholstery: 0,6 m / 0.2 yds — Leather upholstery: 1,4 m² / 15.1 ft²

Bar & Counter Stool w.back

Textile upholstery: 0,8m/0.3 yds — Leather upholstery 1,9m² / 20.5 ft²

Stool

Textile upholstery: 0,6 m / 0.2 yds — Leather upholstery: 1,4 m² / 15.1 ft²

TESTS & CERTIFICATIONS

EN 16139:2013 - L2

Extreme use Furniture - Strength, durability and safety. Requirements for non-domestic seating.

EN 1022:2005 - L2

Extreme use Domestic furniture - Seating - Determination of stability.

ANSI/BIFMA X5.4-2012*

American National Standard For Office Furnishings. Lounge and Public Seating. *Tested on Tube, Sled, Wood and A-Base versions.

ANSI/BIFMA X5.1-2017*

American National Standard For Office Furnishings. General Purpose Office Chairs. *Tested on swivel base w.o. return and wood base versions.

ANSI/BIFMA X5.4-2020*

American National Standard For Office Furnishings. Lounge and Public Seating. *Tested on Tube Base versions

EU Ecolabel*

The Fiber Series without upholstery is EU Ecolabel Certified. By carrying the EU Ecolabel Certification, the product is guaranteed to have a reduced environmental impact throughout the total lifecycle of the product from raw material to disposal.

*Please note that the Fiber Chair with recycled plastic will be available in North America in 2024. Therefore, the North American versions are not EU Ecolabel Certified.

Declare.	Fiber Chairs and Stools without upholstery (except Fiber chairs with A-base) are Living Building Challenge Red List Approved as part of Muuto's participation in Declare.
Global GreenTag Green-Rate™	Fiber Chairs and Stools without upholstery and a large selection of versions upholstered with selected Kvadrat textiles ² are Global GreenTag GreenRate Level C certified. <i>Please note: The Global GreenTag Label only applies for contract market orders with a minimum 5-year warranty.</i>
VOC CDPH 01350 & VOC BIFMA X7.1.	Fiber Chairs and Stools without upholstery and a large selection of versions upholstered with Easy, Refine or Grace Leather or selected Kvadrat textiles ¹ are tested to VOC CDPH 01350 and VOC BIFMA X7.1. ¹ Upholstered Muuto products that are tested to VOC CDPH 01350 and VOC BIFMA X7.1. are only compliant when upholstered with the following Kvadrat textiles: Balder, Canvas, Clara, Clay, Divina, Divina MD, Divina mélange, Fiord, Hallingdal, Hero, Remix, Re-wool, Steelcut, Steelcut Trio, Vidar, Twill weave. ² Upholstered EU/US and UK versions of Fiber Chairs and Fiber Stools only have the GreenTag certificate when upholstered with the following Kvadrat textiles: Canvas, Clara, Divina, Divina MD, Divina melange, Fiord, Hallingdal, Hero, Remix, Re-wool, Steelcut, Steelcut trio, Twill Weave, Vidar.
Forest Stewardship Council™	Fiber Chairs without upholstery are made using FSC™-certified (FSC-CO28824) wood fibers. Fiber Chairs with Wood Base are made using FSC™-certified (FSC-CO28824) wood.

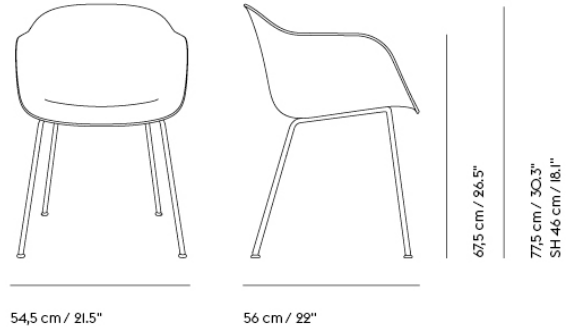

Shipper Colli	1
Gross Weight (kg)	9
Net Weight (kg)	7
Base color options	Anthracite Black, Chrome, Dusty Green, Grey or White
Warranty Period	10 years

Pattern No.	Color	Contract Price	Lead Time
Ready-To-Ship US Warehouse			
MFIBATUBF-BLCK-BLCK	Black/Anthracite Black (Recycled Plastic)	USD 415.00	-
MFIBATUBF-GREY-GREY	Grey/Grey (Recycled Plastic)	USD 415.00	-
MFIBATUBF-WHIT-WHIT	Natural White/White (Recycled Plastic)	USD 415.00	-
MFIBATUBF-BLCK-OCHR	Ochre/Anthracite Black (Recycled Plastic)	USD 415.00	-
MFIBATUBU-BLCK-M136BLCK	Refine Leather Black/Anthracite Black ***	USD 1,416.00	-
MFIBATUBU-BLCK-M136COGN	Refine Leather Cognac/Anthracite Black	USD 1,416.00	-
Ready-To-Ship EU Warehouse			
MFIBATUBF-DGRN-DGRN	Dusty Green/Dusty Green (Recycled Plastic)	USD 415.00	-
Extras			
80175	Black	USD 6.00	-
80172	Dusty Green	USD 6.00	-
80173	Grey	USD 6.00	-
MGLDOFVTBPB1	Plastic glides for Oslo, Fiber and Visu with Tube Base (1 pc per pack) - Black	USD 6.00	-
MGLDOFVTBFB4	Felt Glides for Oslo, Fiber and Visu with Tube Base (4 pcs per pack)	USD 21.00	-
MLEAKIT	Leather care set for Refine Leather	USD 27.00	-

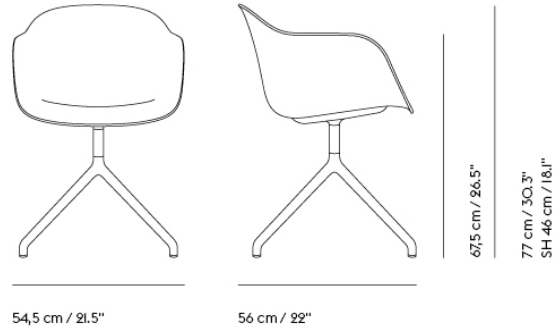

Shipper Colli	1
Gross Weight (kg)	11.9
Net Weight (kg)	7
Base color options	Anthracite Black, White, Grey, Dusty Green or Polished Aluminum.
Warranty Period	10 years

Pattern No.	Color	Contract Price	Lead Time
Ready-To-Ship US Warehouse			
MFIBASWBU-BLCK-M136BLCK	Refine Leather Black/Anthracite Black	USD 1,570.00	-
MFIBASWBU-BLCK-M136COGN	Refine Leather Cognac/Anthracite Black	USD 1,570.00	-
Extras			
MGLDFVSWPB1	Glides for Fiber and Visu with Swivel Base (1 pc per pack) - Black	USD 6.00	-
MGLDFVSWFB4	Felt Glides for Fiber and Visu with Swivel Base (4 pcs per pack)	USD 21.00	-
MLEAKIT	Leather care set for Refine Leather	USD 27.00	-

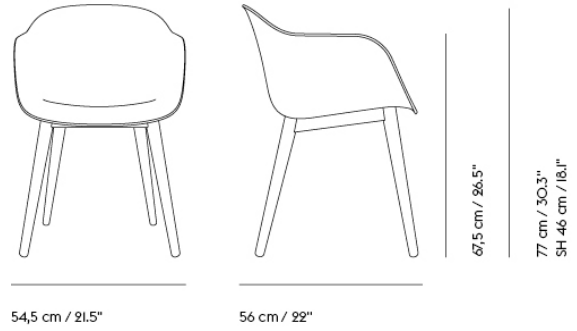

Shipper Colli	1
Gross Weight (kg)	9
Net Weight (kg)	7
Base color options	Anthracite Black, Dusty Green, Grey, Oak or Stained Dark Brown
Warranty Period	10 years

Pattern No.	Color	Contract Price	Lead Time
Ready-To-Ship US Warehouse			
MFIBAWODF-BLCK-BLCK	Black/Anthracite Black (Recycled Plastic)	USD 520.00	-
MFIBAWODF-STDB-BLCK	Black/Stained Dark Brown (Recycled Plastic) ***	USD 520.00	-
MFIBAWODF-GREY-GREY	Grey/Grey (Recycled Plastic)	USD 520.00	-
MFIBAWODF-OAK-WHIT	Natural White/Oak (Recycled Plastic)	USD 520.00	-
MFIBAWODU-GREY-M156133	Remix I33/Grey ***	USD 881.00	-
MFIBAWODU-OAK-M136COGN	Refine Leather Cognac/Oak	USD 1,465.00	-
Ready-To-Ship EU Warehouse			
MFIBAWODF-DGRN-DGRN	Dusty Green/Dusty Green (Recycled Plastic)	USD 520.00	-
MFIBAWODF-OAK-OCHR	Ochre/Oak (Recycled Plastic)	USD 520.00	-
Extras			
80161	Black	USD 21.00	-
MGLDFWDFB4	Felt Glides for Fiber Wood Base (4 pcs per pack) - Black	USD 21.00	-
MGLDFWDFG4	Felt Glides for Fiber Wood Base (4 pcs per pack) - Grey	USD 21.00	-
80151	Grey	USD 21.00	-
MLEAKIT	Leather care set for Refine Leather	USD 27.00	-

FIBER ARMCHAIR / SWIVEL BASE W. CASTORS & GAS LIFT

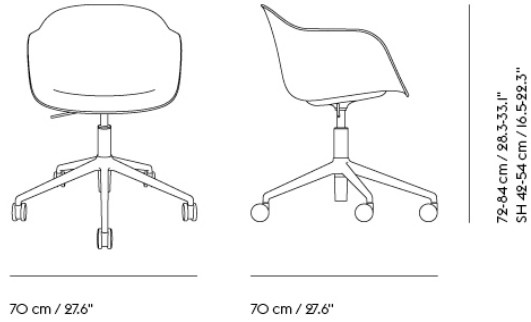

Shipper Colli	1
Gross Weight (kg)	12.6
Net Weight (kg)	7
Base color options	Anthracite Black, Grey and Polished Aluminum with Black castors. White with white castors.
Warranty Period	10 years

Pattern No.	Color	Contract Price	Lead Time
Ready-To-Ship US Warehouse			
MFIBASWGU-ALUM-M156183	Remix I83/Polished Aluminum	USD 1,101.00	-
Extras			
MLEAKIT	Leather care set for Refine Leather	USD 27.00	-

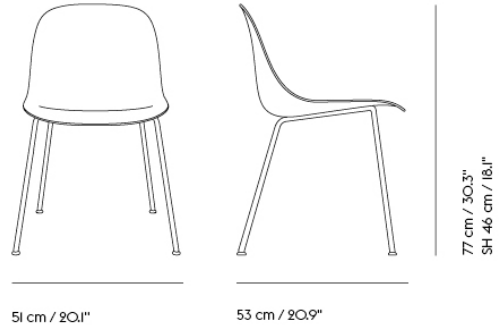

Shipper Colli	1
Gross Weight (kg)	9
Net Weight (kg)	7
Base color options	Anthracite Black, Chrome, Dusty Green, Grey or White
Warranty Period	10 Years

Pattern No.	Color	Contract Price	Lead Time
Ready-To-Ship US Warehouse			
MFIBSTUBF-BLCK-BLCK	Black/Anthracite Black (Recycled Plastic)	USD 383.00	-
MFIBSTUBF-GREY-GREY	Grey/Grey (Recycled Plastic)	USD 383.00	-
MFIBSTUBF-WHIT-WHIT	Natural White/White (Recycled Plastic)	USD 383.00	-
MFIBSTUBF-BLCK-OCHR	Ochre/Anthracite Black (Recycled Plastic)	USD 383.00	-
MFIBSTUBU-BLCK-M136COGN	Refine Leather Cognac/Anthracite Black ***	USD 1,206.00	-
Ready-To-Ship EU Warehouse			
MFIBSTUBF-DGRN-DGRN	Dusty Green/Dusty Green (Recycled Plastic)	USD 383.00	-
Extras			
80175	Black	USD 6.00	-
80172	Dusty Green	USD 6.00	-
80173	Grey	USD 6.00	-
MGLDOFVTBPB1	Plastic glides for Oslo, Fiber and Visu with Tube Base (1 pc per pack) - Black	USD 6.00	-
MGLDOFVTBFB4	Felt Glides for Oslo, Fiber and Visu with Tube Base (4 pcs per pack)	USD 21.00	-
MLEAKIT	Leather care set for Refine Leather	USD 27.00	-

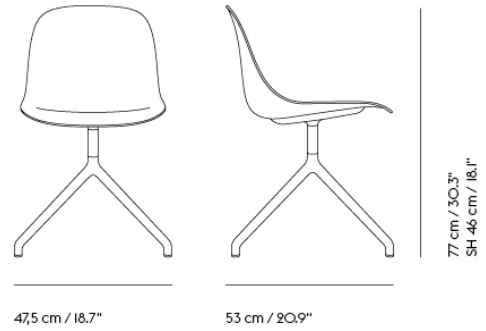

Shipper Colli	1
Gross Weight (kg)	11.9
Net Weight (kg)	7.2
Base color options	Anthracite Black, Dusty Green, Grey, Polished Aluminum or White
Warranty Period	10 years

Pattern No.	Color	Contract Price	Lead Time
Ready-To-Ship US Warehouse			
MFIBSSWBU-BLCK-M136COGN	Refine Leather Cognac/Anthracite Black	USD 1,360.00	-
Extras			
MGLDFVSWPB1	Glides for Fiber and Visu with Swivel Base (1 pc per pack) - Black	USD 6.00	-
MGLDFVSWFB4	Felt Glides for Fiber and Visu with Swivel Base (4 pcs per pack)	USD 21.00	-
MLEAKIT	Leather care set for Refine Leather	USD 27.00	-

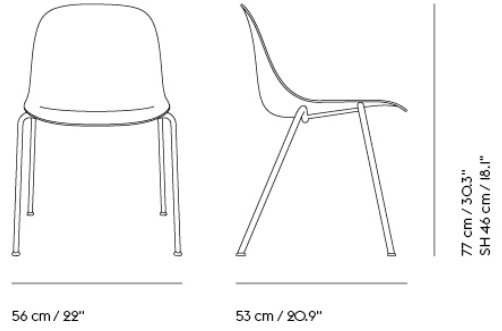

Shipper Colli	1
Gross Weight (kg)	10.3
Net Weight (kg)	7.4
Base color options	Chrome
Stacking	Up to 15 shell or 10 upholstered chairs can be stacked together
Warranty Period	10 years

Pattern No.	Color	Contract Price	Lead Time
Ready-To-Ship US Warehouse			
MFIBSAFGF-CHRO-GREY	Grey/Chrome (Recycled Plastic)	USD 383.00	-
MFIBSAFGF-CHRO-WHIT	Natural White/Chrome (Recycled Plastic)	USD 383.00	-

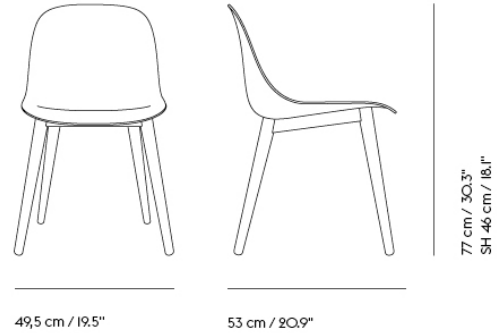

Shipper Colli	1
Gross Weight (kg)	7.4
Net Weight (kg)	5.4
Base color options	Anthracite Black, Dusty Green, Grey, Oak or Stained Dark Brown
Warranty Period	10 years

Pattern No.	Color	Contract Price	Lead Time
Ready-To-Ship US Warehouse			
MFIBSWODF-BLCK-BLCK	Black/Anthracite Black (Recycled Plastic)	USD 488.00	-
MFIBSWODF-STDB-BLCK	Black/Stained Dark Brown (Recycled Plastic)	USD 488.00	-
MFIBSWODF-GREY-GREY	Grey/Grey (Recycled Plastic)	USD 488.00	-
MFIBSWODF-OAK-WHIT	Natural White/Oak (Recycled Plastic)	USD 488.00	-
MFIBSWODU-OAK-M136COGN	Refine Leather Cognac/Oak	USD 1,311.00	-
Ready-To-Ship EU Warehouse			
MFIBSWODF-DGRN-DGRN	Dusty Green/Dusty Green (Recycled Plastic)	USD 488.00	-
MFIBSWODF-OAK-OCHR	Ochre/Oak (Recycled Plastic)	USD 488.00	-
Extras			
80161	Black	USD 21.00	-
MGLDFWDFB4	Felt Glides for Fiber Wood Base (4 pcs per pack) - Black	USD 21.00	-
MGLDFWDFG4	Felt Glides for Fiber Wood Base (4 pcs per pack) - Grey	USD 21.00	-
80151	Grey	USD 21.00	-
MLEAKIT	Leather care set for Refine Leather	USD 27.00	-



Shipper Colli	1
Gross Weight (kg)	11.5
Net Weight (kg)	8
Base color options	Anthracite Black, Dusty Green, Grey, Oak or Stained Dark Brown
Warranty Period	10 years

Pattern No.	Color	Contract Price	Lead Time
Ready-To-Ship US Warehouse			
MFIBLWODF-BLCK-BLCK	Black/Anthracite Black ***	USD 803.00	-
MFIBLWODF-OAK-WHIT	Natural White/Oak ***	USD 803.00	-
MFIBLWODU-OAK-M139236	Steelcut Trio 236/Oak	USD 1,465.00	-
Ready-To-Ship EU Warehouse			
MFIBLWODU-GREY-M156133	Remix 133/Grey	USD 1,360.00	-
Extras			
80161	Black	USD 21.00	-
MGLDFWDFB4	Felt Glides for Fiber Wood Base (4 pcs per pack) - Black	USD 21.00	-
MGLDFWDFG4	Felt Glides for Fiber Wood Base (4 pcs per pack) - Grey	USD 21.00	-
80151	Grey	USD 21.00	-
MLEAKIT	Leather care set for Refine Leather	USD 27.00	-

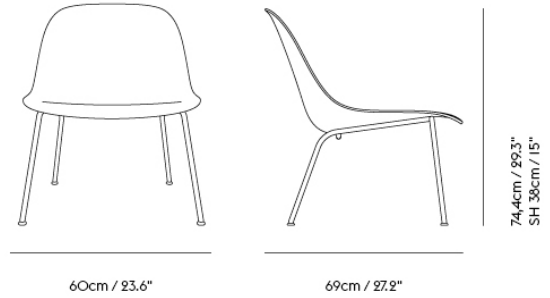

Shipper Colli	1
Gross Weight (kg)	11.5
Net Weight (kg)	8
Base color options	Anthracite Black, Dusty Green, Grey or White
Warranty Period	10 years

Pattern No.	Color	Contract Price	Lead Time
Ready-To-Ship US Warehouse			
MFIBLTUBF-WHIT-WHIT	Natural White/White	USD 597.00	-
MFIBLTUBU-BLCK-M139236	Steelcut Trio 236/Anthracite Black	USD 1,311.00	-
Ready-To-Ship EU Warehouse			
MFIBLTUBU-GREY-M156133	Remix 133/Grey	USD 1,150.00	-
MFIBLTUBU-BLCK-M150154	Divina 154/Anthracite Black ***	USD 1,416.00	-
Extras			
80175	Black	USD 6.00	-
80172	Dusty Green	USD 6.00	-
80173	Grey	USD 6.00	-
MGLDOFVTBPB1	Plastic glides for Oslo, Fiber and Visu with Tube Base (1 pc per pack) - Black	USD 6.00	-
MGLDOFVTBFB4	Felt Glides for Oslo, Fiber and Visu with Tube Base (4 pcs per pack)	USD 21.00	-
MLEAKIT	Leather care set for Refine Leather	USD 27.00	-

FIBER COUNTER STOOL / WOOD BASE - 65 CM / 25.6"

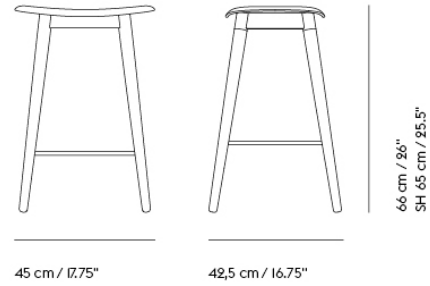

Shipper Colli	1
Gross Weight (kg)	6.1
Net Weight (kg)	4.6
Base color options	Anthracite Black, Dusty Green, Grey, Oak or Stained Dark Brown
Warranty Period	10 years

Pattern No.	Color	Contract Price	Lead Time
Ready-To-Ship US Warehouse			
MFIBSTWODCF-BLCK-BLCK	Black/Anthracite Black	USD 541.00	-
MFIBSTWODCF-GREY-GREY	Grey/Grey	USD 541.00	-
MFIBSTWODCF-OAK-WHIT	Natural White/Oak	USD 541.00	-
MFIBSTWODCU-OAK-M136COGN	Refine Leather Cognac/Oak	USD 1,013.00	-
Extras			
80161	Black	USD 21.00	-
MGLDFWDFB4	Felt Glides for Fiber Wood Base (4 pcs per pack) - Black	USD 21.00	-
MGLDFWDFG4	Felt Glides for Fiber Wood Base (4 pcs per pack) - Grey	USD 21.00	-
80151	Grey	USD 21.00	-
MLEAKIT	Leather care set for Refine Leather	USD 27.00	-

FIBER COUNTER STOOL / WOOD BASE - WITH BACKREST - 65 CM / 25.6"

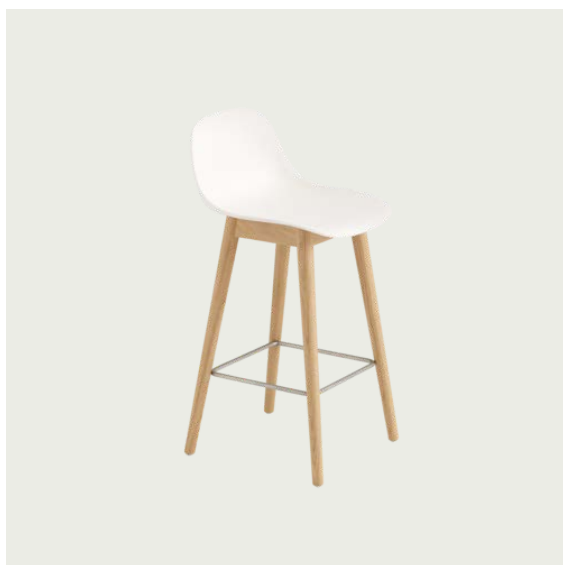

Shipper Colli	1
Gross Weight (kg)	7.2
Net Weight (kg)	5.7
Base color options	Anthracite Black, Dusty Green, Grey, Oak or Stained Dark Brown
Warranty Period	10 years

Pattern No.	Color	Contract Price	Lead Time
Ready-To-Ship US Warehouse			
MFIBSTWODCBF-BLCK-BLCK	Black/Anthracite Black (Recycled Plastic)	USD 576.00	-
MFIBSTWODCBF-STDB-BLCK	Black/Stained Dark Brown (Recycled Plastic) ***	USD 576.00	-
MFIBSTWODCBF-OAK-WHIT	Natural White/Oak	USD 576.00	-
MFIBSTWODCBU-OAK-M136COGN	Refine Leather Cognac/Oak	USD 1,206.00	-
Ready-To-Ship EU Warehouse			
MFIBSTWODCBF-GREY-GREY	Grey/Grey (Recycled Plastic)	USD 576.00	-
Extras			
80161	Black	USD 21.00	-
MGLDFWDFB4	Felt Glides for Fiber Wood Base (4 pcs per pack) - Black	USD 21.00	-
MGLDFWDFG4	Felt Glides for Fiber Wood Base (4 pcs per pack) - Grey	USD 21.00	-
80151	Grey	USD 21.00	-
MLEAKIT	Leather care set for Refine Leather	USD 27.00	-

FIBER COUNTER STOOL / TUBE BASE - 65 CM / 25.6"

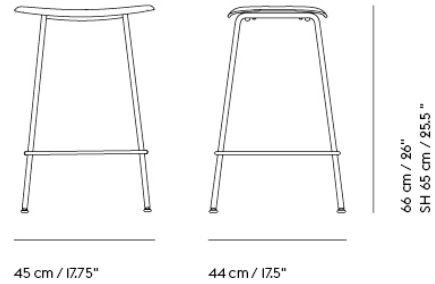

Shipper Colli	1
Gross Weight (kg)	6.1
Net Weight (kg)	4.6
Base color options	Anthracite Black, Dusty Green, Grey or White
Warranty Period	10 years

Pattern No.	Color	Contract Price	Lead Time
Ready-To-Ship US Warehouse			
MFIBSTTUBCF-BLCK-BLCK	Black/Anthracite Black (Recycled Plastic)	USD 341.00	-
MFIBSTTUBCF-GREY-GREY	Grey/Grey ***	USD 341.00	-
MFIBSTTUBCF-WHIT-WHIT	Natural White/White ***	USD 341.00	-
MFIBSTTUBCU-BLCK-M136BLCK	Refine Leather Black/Anthracite Black ***	USD 803.00	-
MFIBSTTUBCU-BLCK-M136COGN	Refine Leather Cognac/Anthracite Black	USD 803.00	-
Extras			
80175	Black	USD 6.00	-
80172	Dusty Green	USD 6.00	-
80173	Grey	USD 6.00	-
MGLDOFVTBPB1	Plastic glides for Oslo, Fiber and Visu with Tube Base (1 pc per pack) - Black	USD 6.00	-
MGLDOFVTBFB4	Felt Glides for Oslo, Fiber and Visu with Tube Base (4 pcs per pack)	USD 21.00	-
MLEAKIT	Leather care set for Refine Leather	USD 27.00	-

FIBER COUNTER STOOL / TUBE BASE - WITH BACKREST - 65 CM / 25.6"

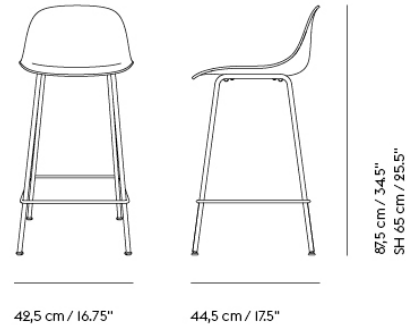
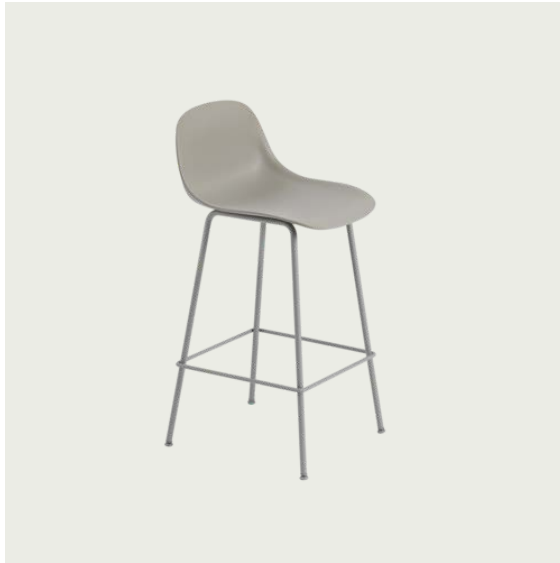

Shipper Colli	1
Gross Weight (kg)	7.2
Net Weight (kg)	5.7
Base color options	Anthracite Black, Dusty Green, Grey or White
Warranty Period	10 years

Pattern No.	Color	Contract Price	Lead Time
Ready-To-Ship US Warehouse			
MFIBSTTUBCBF-BLCK-BLCK	Black/Anthracite Black (Recycled Plastic)	USD 383.00	-
MFIBSTTUBCBF-GREY-GREY	Grey/Grey	USD 383.00	-
MFIBSTTUBCBF-WHIT-WHIT	Natural White/White (Recycled Plastic)	USD 383.00	-
MFIBSTTUBCBU-BLCK-M136COGN	Refine Leather Cognac/Anthracite Black	USD 1,013.00	-
Extras			
80175	Black	USD 6.00	-
80172	Dusty Green	USD 6.00	-
80173	Grey	USD 6.00	-
MGLDOFVTBPB1	Plastic glides for Oslo, Fiber and Visu with Tube Base (1 pc per pack) - Black	USD 6.00	-
MGLDOFVTBFB4	Felt Glides for Oslo, Fiber and Visu with Tube Base (4 pcs per pack)	USD 21.00	-
MLEAKIT	Leather care set for Refine Leather	USD 27.00	-

FIBER BAR STOOL / WOOD BASE - 75 CM / 29.5"

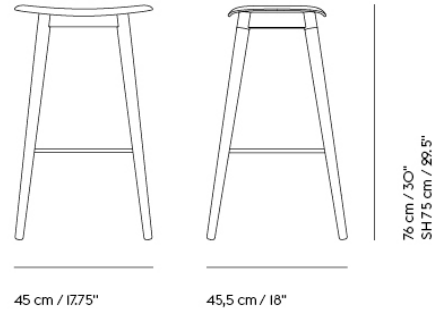

Shipper Colli	1
Gross Weight (kg)	7.1
Net Weight (kg)	5.1
Base color options	Anthracite Black, Dusty Green, Grey, Oak or Stained Dark Brown
Warranty Period	10 years

Pattern No.	Color	Contract Price	Lead Time
Ready-To-Ship US Warehouse			
MFIBSTWODBF-BLCK-BLCK	Black/Anthracite Black (Recycled Plastic)	USD 541.00	-
MFIBSTWODBF-GREY-GREY	Grey/Grey	USD 541.00	-
MFIBSTWODBF-OAK-WHIT	Natural White/Oak (Recycled Plastic)	USD 541.00	-
MFIBSTWODBU-BLCK-M136BLCK	Refine Leather Black/Anthracite Black ***	USD 1,013.00	-
MFIBSTWODBU-OAK-M136COGN	Refine Leather Cognac/Oak	USD 1,013.00	-
Extras			
80161	Black	USD 21.00	-
MGLDFWDFB4	Felt Glides for Fiber Wood Base (4 pcs per pack) - Black	USD 21.00	-
MGLDFWDFG4	Felt Glides for Fiber Wood Base (4 pcs per pack) - Grey	USD 21.00	-
80151	Grey	USD 21.00	-
MLEAKIT	Leather care set for Refine Leather	USD 27.00	-

FIBER BAR STOOL / WOOD BASE - WITH BACKREST - 75 CM / 29.5"

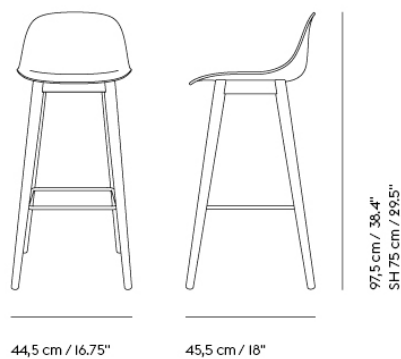
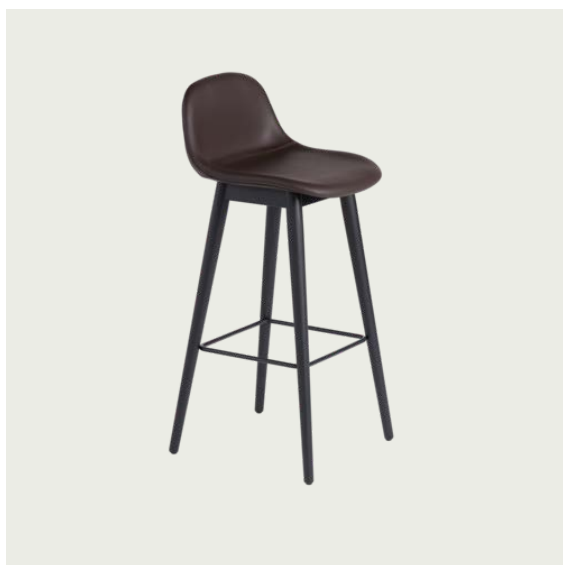

Shipper Colli	1
Gross Weight (kg)	8.2
Net Weight (kg)	6.2
Base color options	Anthracite Black, Dusty Green, Grey, Oak or Stained Dark Brown
Warranty Period	10 years

Pattern No.	Color	Contract Price	Lead Time
Ready-To-Ship US Warehouse			
MFIBSTWODBBF-BLCK-BLCK	Black/Anthracite Black (Recycled Plastic)	USD 576.00	-
MFIBSTWODBBF-STDB-BLCK	Black/Stained Dark Brown ***	USD 576.00	-
MFIBSTWODBBF-GREY-GREY	Grey/Grey	USD 576.00	-
MFIBSTWODBBF-OAK-WHIT	Natural White/Oak (Recycled Plastic)	USD 576.00	-
MFIBSTWODBBU-BLCK-M136BLCK	Refine Leather Black/Anthracite Black ***	USD 1,206.00	-
MFIBSTWODBBU-OAK-M136COGN	Refine Leather Cognac/Oak	USD 1,206.00	-
Extras			
80161	Black	USD 21.00	-
MGLDFWDFB4	Felt Glides for Fiber Wood Base (4 pcs per pack) - Black	USD 21.00	-
MGLDFWDFG4	Felt Glides for Fiber Wood Base (4 pcs per pack) - Grey	USD 21.00	-
80151	Grey	USD 21.00	-
MLEAKIT	Leather care set for Refine Leather	USD 27.00	-

FIBER BAR STOOL / TUBE BASE - 75 CM / 29.5"

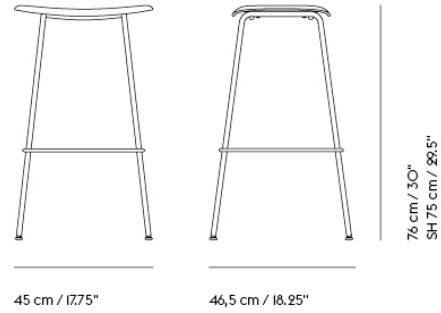

Shipper Colli	1
Gross Weight (kg)	7.1
Net Weight (kg)	5.1
Base color options	Anthracite Black, Dusty Green, Grey or White
Warranty Period	10 years

Pattern No.	Color	Contract Price	Lead Time
Ready-To-Ship US Warehouse			
MFIBSTTUBBF-BLCK-BLCK	Black/Anthracite Black	USD 341.00	-
MFIBSTTUBBF-GREY-GREY	Grey/Grey	USD 341.00	-
MFIBSTTUBBF-WHIT-WHIT	Natural White/White	USD 341.00	-
MFIBSTTUBBU-BLCK-M136BLCK	Refine Leather Black/Anthracite Black ***	USD 803.00	-
MFIBSTTUBBU-BLCK-M136COGN	Refine Leather Cognac/Anthracite Black	USD 803.00	-
Extras			
80175	Black	USD 6.00	-
80172	Dusty Green	USD 6.00	-
80173	Grey	USD 6.00	-
MGLDOFVTBPB1	Plastic glides for Oslo, Fiber and Visu with Tube Base (1 pc per pack) - Black	USD 6.00	-
MGLDOFVTBFB4	Felt Glides for Oslo, Fiber and Visu with Tube Base (4 pcs per pack)	USD 21.00	-
MLEAKIT	Leather care set for Refine Leather	USD 27.00	-

FIBER BAR STOOL / TUBE BASE - WITH BACKREST - 75 CM / 29.5"



Shipper Colli	1
Gross Weight (kg)	8.2
Net Weight (kg)	6.2
Base color options	Anthracite Black, Dusty Green, Grey or White
Warranty Period	10 years

Pattern No.	Color	Contract Price	Lead Time
Ready-To-Ship US Warehouse			
MFIBSTTUBBBF-BLCK-BLCK	Black/Anthracite Black (Recycled Plastic)	USD 383.00	-
MFIBSTTUBBBF-GREY-GREY	Grey/Grey (Recycled Plastic)	USD 383.00	-
MFIBSTTUBBBF-WHIT-WHIT	Natural White/White	USD 383.00	-
MFIBSTTUBBBF-BLCK-OCHR	Ochre/Black (Recycled Plastic)	USD 383.00	-
MFIBSTTUBBBU-BLCK-M136COGN	Refine Leather Cognac/Anthracite Black	USD 1,013.00	-
Extras			
80175	Black	USD 6.00	-
80172	Dusty Green	USD 6.00	-
80173	Grey	USD 6.00	-
MGLDOFVTBPB1	Plastic glides for Oslo, Fiber and Visu with Tube Base (1 pc per pack) - Black	USD 6.00	-
MGLDOFVTBFB4	Felt Glides for Oslo, Fiber and Visu with Tube Base (4 pcs per pack)	USD 21.00	-
MLEAKIT	Leather care set for Refine Leather	USD 27.00	-

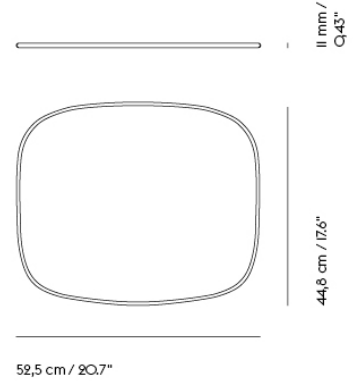

Shipper Colli 1
 Gross Weight (kg) 0.45
 Net Weight (kg) 0.35
 Warranty Period 5 years

Pattern No.	Color	Contract Price	Lead Time
Ready-To-Ship EU Warehouse			
MFIBLGPAD-M156133	Remix I33	USD 100.00	-
MFIBLGPAD-M141BLCK	Easy Leather Black	USD 121.00	-

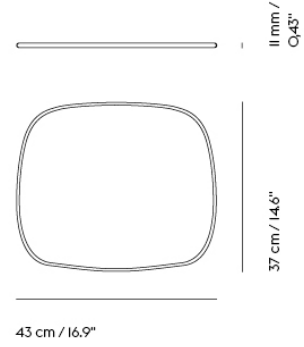

Shipper Colli	1
Gross Weight (kg)	0.35
Net Weight (kg)	0.25
Warranty Period	5 years

Pattern No.	Color	Contract Price	Lead Time
Ready-To-Ship US Warehouse			
MFIBASPAD-M156133	Remix I33	USD 93.00	-
MFIBASPAD-M141BLCK	Easy Leather Black	USD 110.00	-

FIBER ARMCHAIR WOOD, TUBE & SLED BASE

FIBER ARMCHAIR
WOOD BASE

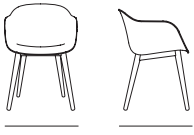

54,5 cm / 21.5"

56 cm / 22"

FIBER ARMCHAIR
TUBE BASE

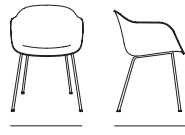

54,5 cm / 21.5"

56 cm / 22"

FIBER ARMCHAIR
SLED BASE

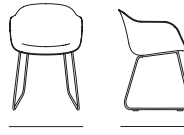

54,5 cm / 21.5"

55 cm / 21.75"

77 cm /
30.3"
SH 46 cm /
18.1"

All Variants

		Upholstery Grades												
				COM			CIL			COL				
Description	Pattern No.	Fiber Shell	A	B	C	E	G	H	R	T	U	V	W	
Fiber Armchair Wood Base														
Fiber Shell	MFIBAWODF	520												
Upholstered Shell	MFIBAWODU		881	1,013	1,150	1,150	1,150	1,465	1,416	1,465	1,570	1,885	2,046	
Front Upholstery	MFIBAWODFR		866	992	1,101	1,150	1,150	1,465	1,360	1,465	1,570	1,836	1,941	
Fiber Armchair Tube Base														
Fiber Shell	MFIBATUBF	415												
Upholstered Shell	MFIBATUBU		776	902	1,013	1,024	1,101	1,416	1,255	1,416	1,465	1,731	1,885	
Front Upholstery	MFIBATUBFR		755	881	992	1,013	1,101	1,311	1,255	1,311	1,416	1,731	1,885	
Fiber Armchair Sled Base														
Fiber Shell	MFIBASLDF	415												
Upholstered Shell	MFIBASLDU		776	902	1,013	1,024	1,045	1,416	1,255	1,416	1,465	1,731	1,885	
Front Upholstery	MFIBASLDFR		755	881	992	1,013	1,101	1,311	1,255	1,311	1,416	1,731	1,885	

HOW TO CONFIGURE

ORDER CODE EXAMPLE: Upholstered Shell

Fiber Shell	Upholstered Shell	Front Upholstery	Fiber Armchair Wood Base Steelcut Trio 226		
Specify: Step 1) Choose variant Step 2) Choose base color Step 3) Choose Fiber Shell color	Step 1) Choose variant Step 2) Choose base color Step 3) Choose upholstery Step 4) Choose upholstery color	Step 1) Choose variant Step 2) Choose base color Step 3) Choose Fiber Shell color Step 4) Choose upholstery Step 5) Choose upholstery color	Variant	Fiber Armchair Wood Base - Upholstered	MFIBAWODU
			Base color	Oak	OAK
			Upholstery	Steelcut Trio	M139
			Upholstery color	226	226
			Final Pattern No:	MFIBAWODUOAKM139226	

Base Color Options

Shell Color Options*

*When ordering Shell and Front Upholstery versions:

Tube and Sled Base:
BLCK - Black
WHIT - White
DGRN - Dusty Green
GREY - Grey
Tube base only: CHRO - Chrome

Wood base:
OAK - Oak

STDB - Stained Dark Brown
BLCK - Black
GREY - Grey
DGRN - Dusty Green

Base and Shell can be combined as follows

Sled and Tube Base
BLCK/BLCK - Black/Black Shell
GREY/GREY - Grey/Grey Shell
WHIT/WHIT - White/Natural White Shell
DGRN/DGRN - Dusty Green/Dusty Green
BLCK/OCHR - Black/Ochre Shell
CHRO/(all colors) - Chrome/(Choose any of the shell colors)

Wood base:
BLCK/BLCK - Black/Black Shell
GREY/GREY - Grey/Grey Shell
OAK/WHIT - Oak/Natural White Shell
DGRN/DGRN - Dusty Green/Dusty Green
OAK/OCHR - Oak/Ochre Shell
STDB/(all colors) - Stained Dark Brown/(Choose any of the shell colors)

All other combinations are available as specials with a 5% upcharge via dealer portal.

Upholstery Options

A	B	C	E	G	H	R	T	U	V	W
Ocean (M161)*	Cameo (K1443)	Hallingdal (M146)	Acca (M12660)	Modern Tweed (K2155)	Stretch Appeal (K2188)	Easy Leather (M141)	Refine Leather (M136)	Endure Leather (M137)	Grace Leather (M12374)	Allure Leather (M12375)
Remix (M156)	Canvas (M153)	Illusion (M12654)	Aegean (K2074)					Volo Leather (VO)		
Wooly (M159)	Clara (M154)		Balder (M152)							
	Fiord (M155)		Beck (M6376)							
	Hero (M164)		Divina (M150)							
	Grain (M12659)		Divina MD (M147)							
	Knoll Hopsack (K1206)		Divina Melange (M135)							
	Manner (M12665)		Eciture (M10767)							
	Prairie (K1925)		Hearth (M12664)							
	Re-Wool (M4586)		Planum (M5904)							
	Sabi (M8404)		Twill Weave (M142)							
	Steelcut (M149)		Vidar (M158)							
	Steelcut Quartet (M13042)									
	Steelcut Trio (M139)									
	Vibe II (K2154)									

*Notes: Ocean - Color 3, 21, 32, 50, 52, 80 & 601
Illusion - Black, Blue, Caribou, Chocolate, Ciel, Dark Green, Dark Caramel, Grey, Light Grey, Mink, Matrine, Petrol, Stone, Taupe, Tile

FIBER ARMCHAIR SWIVEL BASE W. CASTORS & CASTORS & GASLIFT

FIBER ARMCHAIR
SWIVEL BASE

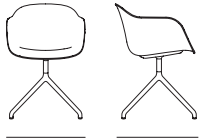

54,5 cm / 21.5"

FIBER ARMCHAIR
SWIVEL BASE W/CASTORS

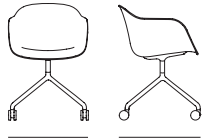

54,5 cm / 21.5" 56 cm / 22"

77 cm /
30.3"
SH 46 cm /
18.1"

FIBER ARMCHAIR SWIVEL BASE
W/CASTORS AND GASLIFT



70 cm / 27.6"

70 cm / 27.6"

72-84 cm /
28.3"-33.1"
SH 42-54 cm /
16.5"-22.3"

Warranty Period 10 years. 5 years for Swivel base w/return

All Variants

All Variants	Description	Pattern No.	Fiber Shell	Upholstery Grades								COL			
				A	B	C	E	G	H	R	T	U	V	W	
Fiber Armchair Swivel Base	Fiber Shell	MFIBASWBF	576												
	Upholstered Shell	MFIBASWBU		933	1,101	1,206	1,206	1,206	1,570	1,465	1,570	1,626	1,941	2,095	
	Front Upholstery	MFIBASWFR		919	1,045	1,150	1,206	1,206	1,570	1,416	1,570	1,626	1,885	2,046	
Fiber Armchair Swivel Base w. Return	Fiber Shell	MFIBASWRF	650												
	Upholstered Shell	MFIBASWRU		1,013	1,150	1,255	1,255	1,255	1,626	1,570	1,626	1,675	2,046	2,151	
	Front Upholstery	MFIBASWFR		992	1,150	1,255	1,255	1,255	1,626	1,465	1,626	1,675	2,046	2,151	
Fiber Armchair Swivel Base w. Castors	Fiber Shell	MFIBASWCF	650												
	Upholstered Shell	MFIBASWCU		1,013	1,150	1,255	1,255	1,255	1,626	1,570	1,626	1,675	2,046	2,151	
	Front Upholstery	MFIBASWCFR		992	1,150	1,255	1,255	1,255	1,626	1,465	1,626	1,675	1,941	2,151	
Fiber Armchair Swivel Base w. Castors & Gas Lift	Fiber Shell	MFIBASWGF	734												
	Upholstered Shell	MFIBASWGU		1,101	1,255	1,360	1,416	1,416	1,675	1,626	1,675	1,836	2,095	2,305	
	Front Upholstery	MFIBASWGR		1,101	1,206	1,311	1,360	1,416	1,675	1,626	1,675	1,731	2,095	2,256	

HOW TO CONFIGURE

ORDER CODE EXAMPLE: Upholstered Shell

Fiber Shell	Upholstered Shell	Front Upholstery	Fiber Armchair Swivel Base with Castors and Gas Lift Aegean in Egret/Dusty Green		
Specify: Step 1) Choose variant Step 2) Choose base color Step 3) Choose Fiber Shell color	Step 1) Choose variant Step 2) Choose base color Step 3) Choose upholstery Step 4) Choose upholstery color	Step 1) Choose variant Step 2) Choose base color Step 3) Choose Fiber Shell color Step 4) Choose upholstery Step 5) Choose upholstery color	Variant Base color Upholstery Upholstery color Final Pattern No:	Castors and gaslift - Upholstered Dusty Green Aegean Egret MFIBAWODUOAKM139226	M-FIBS-SWG-U DGRN K2074 1

Base Color Options

Shell Color Options*

*When ordering Shell and Front Upholstery versions:

Swivel Base and Swivel Base w. Return
BLCK - Anthracite Black
WHIT - White
DGRN - Dusty Green
GREY - Grey
ALUM - Polished Aluminum

BLCK - Black
GREY - Grey
DGRN - Dusty Green
OCHR - Ochre
WHIT - Natural White

Base and Shell can be combined as follows

Swivel Base, Swivel Base w. Return and Swivel Base with castors
BLCK/BLCK - Black/Black Shell
GREY/GREY - Grey/Grey Shell
WHIT/WHIT - White/Natural White Shell
DGRN/DGRN - Dusty Green/Dusty Green

Swivel base with castors and Swivel base with castors & Gaslift
BLCK - Anthracite black with black castors
GREY - Grey with black castors
ALUM - Polished Aluminum with black castors
WHIT - White with white castors

Swivel base w castors & Gaslift
BLCK/BLCK - Black/Black Shell
GREY/GREY - Grey/Grey Shell
WHIT/WHIT - White/Natural White Shell

Polished aluminum combined with any shell color and all other color combinations are available as a special via dealer portal.

Upholstery Options

A	B	C	E	G	H	R	T	U	V	W
Ocean (M161)* Remix (M156) Wooly (M159)	Cameo (K1443) Canvas (M153) Clara (M154) Fiord (M155) Hero (M164) Grain (M12659) Knoll Hopsack (K1206) Manner (M12665) Prairie (K1925) Re-Wool (M4586) Sabi (M8404) Steelcut (M149) Steelcut Quartet (M13042) Steelcut Trio (M139) Vibe II (K2154)	Hallingdal (M146) Illusion (M12654)	Acca (M12660) Aegean (K2074) Balder (M152) Beck (M6376) Divina (M150) Divina MD (M147) Divina Melange (M135) Ecriture (M10767) Hearth (M12664) Planum (M5904) Twill Weave (M142) Vidar (M158)	Modern Tweed (K2155)	Stretch Appeal (K2188)	Easy Leather (M141)	Refine Leather (M136)	Endure Leather (M137) Volo Leather (VO)	Grace Leather (M12374)	Allure Leather (M12375)

*Notes: Ocean - Color 3, 21, 32, 50, 52, 80 & 601
Illusion - Black, Blue, Caribou, Chocolate, Ciel, Dark Green, Dark Caramel, Grey, Light Grey, Mink, Matrine, Petrol, Stone, Taupe, Tile

FIBER SIDE CHAIR WOOD, TUBE & SLED BASE

FIBER SIDE CHAIR
WOOD BASE



49,5 cm / 19.5" 53 cm / 21"

FIBER SIDE CHAIR
TUBE BASE



51 cm / 20" 53 cm / 21"

FIBER SIDE CHAIR
SLED BASE



47,5 cm / 18.75" 51,5 cm / 20.3"

77 cm /
30.3"
SH 46 cm /
18"

All Variants

	Description	Pattern No.	Fiber Shell	Uphol- stery Grades							COL			
				A	B	C	E	G	H	R	T	U	V	W
Fiber Side Chair Wood Base	Fiber Shell	M-FIBS-WOD-F	488											
	Upholstered Shell	M-FIBS-WOD-U		786	919	1,045	1,045	1,101	1,311	1,206	1,311	1,416	1,675	1,836
Fiber Side Chair Tube Base	Fiber Shell	M-FIBS-TUB-F	383											
	Upholstered Shell	M-FIBS-TUB-U		681	807	919	933	954	1,206	1,101	1,206	1,255	1,570	1,675
Fiber Side Chair Sled Base	Fiber Shell	M-FIBS-SLD-F	383											
	Upholstered Shell	M-FIBS-SLD-U		681	807	919	933	954	1,206	1,101	1,206	1,255	1,570	1,675

HOW TO CONFIGURE

ORDER CODE EXAMPLE: Upholstered Shell

Fiber Shell	Upholstered Shell	Fiber Side Chair Wood Base Aegean in Egret/Dusty Green
Specify: Step 1) Choose variant Step 2) Choose base color Step 3) Choose Fiber Shell color	Step 1) Choose variant Step 2) Choose base color Step 3) Choose upholstery Step 4) Choose upholstery color	Variant Base color Upholstery Upholstery color Final Pattern No:
		Fiber Side Chair Wood Base - upholstered Oak Steelcut Trio 226 MFIBSWODUOAKM139226
		M-FIBS-SWG-U OAK M139 2261

Base Color Options

Tube and Sled Base:
BLCK - Black
WHIT - White
DGRN - Dusty Green
GREY - Grey
Tube base only: CHRO - Chrome

Wood base:
OAK - Oak

STDB - Stained Dark Brown
BLCK - Black
GREY - Grey
DGRN - Dusty Green

Shell Color Options*

BLCK - Anthracite Black
GREY - Grey
DGRN - Dusty Green
OCHR - Ochre
WHIT - Natural White

*When ordering Shell and Front Upholstery versions:

Base and Shell can be combined as follows

Sled and Tube Base
BLCK/BLCK - Black/Black Shell
GREY/GREY - Grey/Grey Shell
WHIT/WHIT - White/Natural White Shell
DGRN/DGRN - Dusty Green/Dusty Green
BLCK/OCHR - Black/Ochre Shell
CHRO/(all colors) - Chrome/(Choose any of the shell colors)

Wood base:
BLCK/BLCK - Black/Black Shell
GREY/GREY - Grey/Grey Shell
OAK/WHIT - Oak/Natural White Shell
DGRN/DGRN - Dusty Green/Dusty Green
OAK/OCHR - Oak/Ochre Shell
STDB/(all colors) - Stained Dark Brown/(Choose any of the shell colors)
All other combinations are available as specials with a 5% upcharge via dealer portal.

Upholstery Options

A	B	C	E	G	H	R	T	U	V	W
Ocean (M161)* Remix (M156) Wooly (M159)	Cameo (K1443) Canvas (M153) Clara (M154) Fiord (M155) Hero (M164) Grain (M12659) Knoll Hopsack (K1206) Manner (M12665) Prairie (K1925) Re-Wool (M4586) Sabi (M8404) Steelcut (M149) Steelcut Quartet (M13042) Steelcut Trio (M139) Vibe II (K2154)	Hallingdal (M146) Illusion (M12654)	Acca (M12660) Aegean (K2074) Balder (M152) Beck (M6376) Divina (M150) Divina MD (M147) Divina Melange (M135) Ecriture (M10767) Hearth (M12664) Planum (M5904) Twill Weave (M142) Vidar (M158)	Modern Tweed (K2155)	Stretch Appeal (K2188)	Easy Leather (M141)	Refine Leather (M136)	Endure Leather (M137) Volo Leather (VO)	Grace Leather (M12374)	Allure Leather (M12375)

*Notes:
Ocean - Color 3, 21, 32, 50, 52, 80 & 601
Illusion - Black, Blue, Caribou, Chocolate, Ciel,
Dark Green, Dark Caramel, Grey, Light Grey, Mink,
Matrine, Petrol, Stone, Taupe, Tile

FIBER SIDE CHAIR SWIVEL BASE W. CASTORS & CASTORS & GASLIFT

FIBER SIDE CHAIR SWIVEL BASE



47,5 cm / 18.75" 53 cm / 21"

FIBER SIDE CHAIR SWIVEL BASE W/CASTORS



47,5 cm / 18.75" 53 cm / 21"

77 cm / 30.3"
SH 46 cm / 18.1"

FIBER SIDE CHAIR SWIVEL BASE W/CASTORS AND GASLIFT



70 cm / 27.6" 70 cm / 27.6"

72-84 cm / 28.3"-33.1"
SH 42-54 cm / 16.5"-22.3"

Warranty Period 10 years. 5 years for Swivel base w/return

All Variants

Description	Pattern No.	Fiber Shell	COM							CIL					COL					
			A	B	C	E	G	H	R	T	U	V	W							
Fiber Side Chair Swivel Base	Fiber Shell	M-FIBS-SWB-F	541																	
	Upholstered Shell	M-FIBS-SWB-U		849	971	1,101	1,101	1,150	1,360	1,206	1,360	1,416	1,731	1,836						
Fiber Side Chair Swivel Base w. Return	Fiber Shell	M-FIBS-SWR-F	614																	
	Upholstered Shell	M-FIBS-SWR-U		919	1,045	1,150	1,206	1,206	1,416	1,311	1,416	1,570	1,836	1,885						
Fiber Side Chair Swivel Base w. Castors	Fiber Shell	M-FIBS-SWC-F	614																	
	Upholstered Shell	M-FIBS-SWC-U		919	1,045	1,150	1,206	1,206	1,416	1,311	1,416	1,570	1,836	1,885						
Fiber Side Chair Swivel Base w. Castors & Gas Lift	Fiber Shell	M-FIBS-SWG-F	702																	
	Upholstered Shell	M-FIBS-SWG-U		1,013	1,150	1,255	1,255	1,311	1,570	1,416	1,570	1,626	1,885	2,046						

HOW TO CONFIGURE

Fiber Shell Upholstered Shell

Specify:
Step 1) Choose variant
Step 3) Choose fiber shell color

Step 1) Choose variant
Step 3) Choose upholstery

ORDER CODE EXAMPLE: Upholstered Shell

Fiber Side Chair Swivel Base with Castors and Gas Lift Aegean in Egret/Dusty Green

Variant Base color Upholstery Upholstery color Final Pattern No:
Castors and gaslift upholstered Dusty Green Aegean Egret 1 MFIBSSWGUDGRNK20741

M-FIBS-SWG-U
DGRN
K2074

Base Color Options

Swivel Base and Swivel Base w. Return
BLCK - Anthracite Black
WHIT - White
DGRN - Dusty Green
GREY - Grey
ALUM - Polished Aluminum

Swivel base with castors and Swivel base w castors & Gaslift
BLCK - Anthracite black with black castors
GREY - Grey with black castors
ALUM - Polished Aluminum with black castors
WHIT - White with white castors

Shell Color Options*

BLCK - Black
GREY - Grey
DGRN - Dusty Green
OCHR - Ochre
WHIT - Natural White

*When ordering Shell and Front Upholstery versions:

Base and Shell can be combined as follows

Swivel Base, Swivel Base w. Return and Swivel Base with castors
BLCK/BLCK - Black/Black Shell
GREY/GREY - Grey/Grey Shell
WHIT/WHIT - White/Natural White Shell
DGRN/DGRN - Dusty Green/Dusty Green

Swivel base w castors & Gaslift
BLCK/BLCK - Black/Black Shell
GREY/GREY - Grey/Grey Shell
WHIT/WHIT - White/Natural White Shell

Polished aluminum combined with any shell color and all other color combinations are available as a special via dealer portal.

Upholstery Options

A	B	C	E	G	H	R	T	U	V	W
Ocean (M161)* Remix (M156) Wooly (M159)	Cameo (K1443) Canvas (M153) Clara (M154) Fiord (M155) Hero (M164) Grain (M12659) Knoll Hopsack (K1206) Manner (M12665) Prairie (K1925) Re-Wool (M4586) Sabi (M8404) Steelcut (M149) Steelcut Quartet (M13042) Steelcut Trio (M139) Vibe II (K2154)	Hallingdal (M146) Illusion (M12654)	Acca (M12660) Aegean (K2074) Balder (M152) Beck (M6376) Divina (M150) Divina MD (M147) Divina Melange (M135) Ecriture (M10767) Hearth (M12664) Planum (M5904) Twill Weave (M142) Vidar (M158)	Modern Tweed (K2155)	Stretch Appeal (K2188)	Easy Leather (M141)	Refine Leather (M136)	Endure Leather (M137) Volo Leather (VO)	Grace Leather (M12374)	Allure Leather (M12375)

*Notes:
Ocean - Color 3, 21, 32, 50, 52, 80 & 601
Illusion - Black, Blue, Caribou, Chocolate, Ciel, Dark Green, Dark Caramel, Grey, Light Grey, Mink, Matrine, Petrol, Stone, Taupe, Tile

FIBER SIDE CHAIR A-BASE



FIBER ARMCHAIR SLED BASE



56 cm / 22" 53 cm / 21"

FIBER SIDE CHAIR A-BASE W/LINKING DEVICE

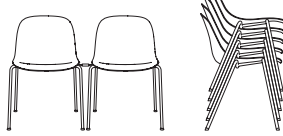

77 cm / 30.3"
SH 46 cm / 18"

Stacking Up to 15 shell or 10 upholstered chairs can be stacked together
Warranty Period 10 years

All Variants

Description	Pattern No.	Fiber Shell	Upholstery Grades					
			A	COM B	CIL C	E	G	
Fiber Side Chair A-Base w. Glides	Fiber Shell	M-FIBS-AGD-F	383					
	Upholstered Shell	M-FIBS-AGD-U		681	807	919	933	954
Fiber Side Chair A-Base w. Felt Glides	Fiber Shell	M-FIBS-AFG-F	394					
	Upholstered Shell	M-FIBS-AFG-U		702	828	933	954	971
Fiber Side Chair A-Base w. Linking Device	Fiber Shell	M-FIBS-ALD-F	383					
	Upholstered Shell	M-FIBS-ALD-U		702	828	933	954	971
Fiber Side Chair A-Base w. Linking Device & Felt Glides	Fiber Shell	M-FIBS-ALF-F	394					
	Upholstered Shell	M-FIBS-ALF-U		681	849	954	971	992

HOW TO CONFIGURE

ORDER CODE EXAMPLE: Upholstered Shell

Fiber Shell	Upholstered Shell	Fiber Side Chair A-Base w/felt glides in Knoll Hopsack Olive	
Specify: Step 1) Choose variant Step 2) Choose shell color	Step 1) Choose variant Step 2) Choose base Color Step 3) Choose upholstery Step 4) Choose upholstery color	Variant Color Upholstery Upholstery color Final Pattern No:	M-FIBS-AFG-U-CHRO K1206 Knoll Hopsack Olive MFIBSAFGUCHROK1206

Base Color Options

A-base:
CHRO - Chrome

Shell Finish Options

BLCK - Black
GREY - Grey
DGRN - Dusty Green
OCHR - Ochre
WHIT - Natural White

Upholstery Options

A	B	C	E	G
Ocean (M161)* Remix (M156) Wooly (M159)	Cameo (K1443) Canvas (M153) Clara (M154) Fiord (M155) Hero (M164) Grain (M12659) Knoll Hopsack (K1206) Manner (M12665) Prairie (K1925) Re-Wool (M4586) Sabi (M8404) Steelcut (M149) Steelcut Quartet (M13042) Steelcut Trio (M139) Vibe II (K2154)	Hallingdal (M146)	Acca (M12660) Aegean (K2074) Balder (M152) Beck (M6376) Divina (M150) Divina MD (M147) Divina Melange (M135) Ecriture (M10767) Hearth (M12664) Planum (M5904) Twill Weave (M142) Vidar (M158)	Modern Tweed (K2155)

*Notes:
Ocean - Color 3, 21, 32, 50, 52, 80 & 601
Illusion - Black, Blue, Caribou, Chocolate, Ciel, Dark Green,
Dark Caramel, Grey, Light Grey, Mink, Matrine, Petrol,
Stone, Taupe, Tile

FIBER STOOL

All Variants

Description	Pattern No.	Fiber Shell	Upholstery Grades											
			A	COM B	CIL C	E	G	H	R	COL T	U	V	W	
Fiber Stool Tube Base	Fiber Shell	M-FIBST-TUB-S-F	289											
	Upholstered Shell	M-FIBST-TUB-S-U		488	520	562	576	597	629	614	629	719	971	971
Fiber Counter Stool Tube Base	Fiber Shell	M-FIBST-TUB-C-F	341											
	Upholstered Shell	M-FIBST-TUB-C-U		597	650	681	702	719	803	719	803	828	1,101	1,101
Fiber Bar Stool Tube Base	Fiber Shell	M-FIBST-TUB-B-F	341											
	Upholstered Shell	M-FIBST-TUB-B-U		597	650	681	702	719	803	719	803	828	1,101	1,101
Fiber Stool Wood Base	Fiber Shell	M-FIBST-WOD-S-F	436											
	Upholstered Shell	M-FIBST-WOD-S-U		719	755	807	828	866	933	919	933	971	1,255	1,255
Fiber Counter Stool Wood Base	Fiber Shell	M-FIBST-WOD-C-F	541											
	Upholstered Shell	M-FIBST-WOD-C-U		881	933	971	992	1,013	1,013	996	1,013	1,024	1,311	1,311
Fiber Bar Stool Wood Base	Fiber Shell	M-FIBST-WOD-B-F	541											
	Upholstered Shell	M-FIBST-WOD-B-U		881	933	971	992	1,013	1,013	996	1,013	1,024	1,311	1,311

HOW TO CONFIGURE

ORDER CODE EXAMPLE: Upholstered Shell

Fiber Shell	Upholstered Shell	Fiber Bar Stool with Tube Base with Castors and Gas Lift Aegean in Egret/Dusty Green
Specify: Step 1) Choose variant Step 2) Choose base color Step 3) Choose Fiber Shell color	Step 1) Choose variant Step 2) Choose base color Step 3) Choose upholstery Step 4) Choose upholstery color	Variant: Fiber Bar Stool, Wood Base Base color: Stained Dark Brown Upholstery: Hero Upholstery color: 751 Final Pattern No: MFIBSTWODBUSTDBM164751

Base Color Options

- Tube Base
- BLCK - Black
- WHIT - White
- DGRN - Dusty Green
- GREY - Grey
- Wood base
- OAK - Oak
- STDB - Stained Dark Brown
- BLCK - Black
- GREY - Grey
- DGRN - Dusty Green

Shell Color Options*

- BLCK - Anthracite Black
- GREY - Grey
- DGRN - Dusty Green
- OCHR - Ochre
- WHIT - Natural White

*When ordering Shell and Front Upholstery versions:

- Base and Shell can be combined as follows
- Tube Base
 - BLCK/BLCK - Black/Black Shell
 - GREY/GREY - Grey/Grey Shell
 - WHIT/WHIT - White/Natural White Shell
 - DGRN/DGRN - Dusty Green/Dusty Green
 - BLCK/OCHR - Black/Ochre Shell
 - Wood base
 - BLCK/BLCK - Black/Black Shell
 - GREY/GREY - Grey/Grey Shell
 - OAK/WHIT - Oak/Natural White Shell
 - DGRN/DGRN - Dusty Green/Dusty Green
 - OAK/OCHR - Oak/Ochre Shell
 - STDB/(all colors) - Stained Dark Brown/(Choose any of the shell colors)
- All other combinations are available as specials with a 5% upcharge via dealer portal.

Upholstery Options

A	B	C	E	G	H	R	T	U	V	W
Ocean (M161)* Remix (M156) Wooly (M159)	Cameo (K1443) Canvas (M153) Clara (M154) Fiord (M155) Hero (M164) Grain (M12659) Knoll Hopsack (K1206) Manner (M12665) Prairie (K1925) Re-Wool (M4586) Sabi (M8404) Steelcut (M149) Steelcut Quartet (M13042) Steelcut Trio (M139) Vibe II (K2154)	Hallingdal (M146) Illusion (M12654)	Acca (M12660) Aegean (K2074) Balder (M152) Beck (M6376) Divina (M150) Divina MD (M147) Divina Melange (M135) Ecriture (M10767) Hearth (M12664) Planum (M5904) Twill Weave (M142) Vidar (M158)	Modern Tweed (K2155)	Stretch Appeal (K2188)	Easy Leather (M141)	Refine Leather (M136)	Endure Leather (M137) Volo Leather (VO)	Grace Leather (M12374)	Allure Leather (M12375)

*Notes:
Ocean - Color 3, 21, 32, 50, 52, 80 & 601
Illusion - Black, Blue, Caribou, Chocolate, Ciel, Dark Green, Dark Caramel, Grey, Light Grey, Mink, Matrine, Petrol, Stone, Taupe, Tile

FIBER STOOL W. BACKREST

All Variants

			Upholstery Grades										
			COM			CIL			COL				
Description	Pattern No.	Fiber Shell	A	B	C	E	G	H	R	T	U	V	W
Fiber Counter Stool Tube Base w. Backrest													
Fiber Shell	M-FIBST-TUB-CB-F	383											
Upholstered Shell	M-FIBST-TUB-CB-U		681	755	807	828	866	1,013	933	1,013	1,024	1,311	1,311
Fiber Bar Stool Tube Base w. Backrest													
Fiber Shell	M-FIBST-TUB-BB-F	383											
Upholstered Shell	M-FIBST-TUB-BB-U		681	755	807	828	866	1,013	933	1,013	1,024	1,311	1,311
Fiber Counter Stool Wood Base w. Backrest													
Fiber Shell	M-FIBST-WOD-CB-F	576											
Upholstered Shell	M-FIBST-WOD-CB-U		971	1,045	1,101	1,150	1,150	1,206	1,150	1,206	1,255	1,570	1,570
Fiber Bar Stool Wood Base w. Backrest													
Fiber Shell	M-FIBST-WOD-BB-F	576											
Upholstered Shell	M-FIBST-WOD-BB-U		971	1,045	1,101	1,150	1,150	1,206	1,150	1,206	1,255	1,570	1,570

HOW TO CONFIGURE

ORDER CODE EXAMPLE: Upholstered Shell

Fiber Shell	Upholstered Shell	Fiber Bar Stool wood base w/backrest Hero 751		
Specify: Step 1) Choose variant Step 2) Choose base color Step 3) Choose Fiber Shell color	Step 1) Choose variant Step 2) Choose base color Step 3) Choose upholstery Step 4) Choose upholstery color	Variant Base color Upholstery Upholstery color Final Pattern No:	Fiber Bar Stool wood base w/backrest Stained Dark Brown Hero 751 MFIBSTWODBUSTDBM164751	MFIBSTWODBBU STDB M164 751

Base Color Options

Tube Base
BLCK - Black
WHIT - White
DGRN - Dusty Green
GREY - Grey

Wood base
OAK - Oak
STDB - Stained Dark Brown
BLCK - Black
GREY - Grey
DGRN - Dusty Green

Shell Color Options*

BLCK - Anthracite Black
GREY - Grey
DGRN - Dusty Green
OCHR - Ochre
WHIT - Natural White

*When ordering Shell and Front Upholstery versions:

Base and Shell can be combined as follows
Tube Base
BLCK/BLCK - Black/Black Shell
GREY/GREY - Grey/Grey Shell
WHIT/WHIT - White/Natural White Shell
DGRN/DGRN - Dusty Green/Dusty Green
BLCK/OCHR - Black/Ochre Shell

Wood base
BLCK/BLCK - Black/Black Shell
GREY/GREY - Grey/Grey Shell
OAK/WHIT - Oak/Natural White Shell
DGRN/DGRN - Dusty Green/Dusty Green
OAK/OCHR - Oak/Ochre Shell
STDB/(all colors) - Stained Dark Brown/(Choose any of the shell colors)

All other combinations are available as specials with a 5% upcharge via dealer portal.

Upholstery Options

A	B	C	E	G	H	R	T	U	V	W
Ocean (M161)* Remix (M156) Wooly (M159)	Cameo (K1443) Canvas (M153) Clara (M154) Fiord (M155) Hero (M164) Grain (M12659) Knoll Hopsack (K1206) Manner (M12665) Prairie (K1925) Re-Wool (M4586) Sabi (M8404) Steelcut (M149) Steelcut Quartet (M13042) Steelcut Trio (M139) Vibe II (K2154)	Hallingdal (M146) Illusion (M12654)	Acca (M12660) Aegean (K2074) Balder (M152) Beck (M6376) Divina (M150) Divina MD (M147) Divina Melange (M135) Ecriture (M10767) Hearth (M12664) Planum (M5904) Twill Weave (M142) Vidar (M158)	Modern Tweed (K2155)	Stretch Appeal (K2188)	Easy Leather (M141)	Refine Leather (M136)	Endure Leather (M137) Volo Leather (VO)	Grace Leather (M12374)	Allure Leather (M12375)

*Notes:
Ocean - Color 3, 21, 32, 50, 52, 80 & 601
Illusion - Black, Blue, Caribou, Chocolate, Ciel, Dark Green, Dark Caramel, Grey, Light Grey, Mink, Matrine, Petrol, Stone, Taupe, Tile

FIBER LOUNGE CHAIR



All Variants

Contract Price

Description	Pattern No.	Fiber Shell	Upholstery Grades											
			COM					CIL						
			A	B	C	E	G	H	R	T	U	V	W	
Fiber Lounge Tube Base	Fiber Shell	M-FIBL-TUB-F	597											
	Upholstered Shell	M-FIBL-TUB-U		1,150	1,311	1,416	1,416	1,416	1,836	1,731	1,836	1,941	2,410	2,620
Fiber Lounge Wood Base	Fiber Shell	M-FIBL-WOD-F	803											
	Upholstered Shell	M-FIBL-WOD-U		1,360	1,465	1,570	1,626	1,626	2,095	1,941	2,095	2,305	2,830	2,935

HOW TO CONFIGURE

ORDER CODE EXAMPLE: Upholstered Shell

Fiber Shell	Upholstered Shell	Fiber Lounge Chair Wood Base Endure Olive / Black base
Specify: Step 1) Choose variant Step 2) Choose base color Step 3) Choose Fiber Shell color	Step 1) Choose variant Step 2) Choose base color Step 3) Choose upholstery Step 4) Choose upholstery color	Variant: Fiber Lounge Chair Wood Base - Upholstered Base color: Black Upholstery: Endure Upholstery color: Olive Final Pattern No: MFIBLWODUBLCKM137OLVE

Base Color Options

Shell Color Options*

*When ordering Shell and Front Upholstery versions:

Tube Base: BLCK - Black WHIT - White DGRN - Dusty Green GREY - Grey Wood base: OAK - Oak STDB - Stained Dark Brown BLCK - Black GREY - Grey DGRN - Dusty Green	BLCK - Black GREY - Grey DGRN - Dusty Green OCHR - Ochre WHIT - Natural White	Base and Shell can be combined as follows Tube Base: BLCK/BLCK - Black/Black Shell GREY/GREY - Grey/Grey Shell WHIT/WHIT - White/Natural White Shell BLCK/OCHR - Black/Ochre Shell Wood base: BLCK/BLCK - Black/Black Shell GREY/GREY - Grey/Grey Shell OAK/WHIT - Oak/Natural White Shell OAK/OCHR - Oak/Ochre Shell STDB/(all colors) - Stained Dark Brown/(Choose any of the shell colors)
--	---	--

All other combinations are available as specials with a 5% upcharge via dealer portal.

Upholstery Options

A	B	C	E	G	H	R	T	U	V	W
Ocean (M161)* Remix (M156) Wooly (M159)	Cameo (K1443) Canvas (M153) Clara (M154) Fiord (M155) Hero (M164) Grain (M12659) Knoll Hopsack (K1206) Manner (M12665) Prairie (K1925) Re-Wool (M4586) Sabi (M8404) Steelcut (M149) Steelcut Quartet (M13042) Steelcut Trio (M139) Vibe II (K2154)	Hallingdal (M146) Illusion (M12654)	Acca (M12660) Aegean (K2074) Balder (M152) Beck (M6376) Divina (M150) Divina MD (M147) Divina Melange (M135) Ecriture (M10767) Hearth (M12664) Planum (M5904) Twill Weave (M142) Vidar (M158)	Modern Tweed (K2155)	Stretch Appeal (K2188)	Easy Leather (M141)	Refine Leather (M136)	Endure Leather (M137) Volo Leather (VO)	Grace Leather (M12374)	Allure Leather (M12375)

*Notes:
Ocean - Color 3, 21, 32, 50, 52, 80 & 601
Illusion - Black, Blue, Caribou, Chocolate, Ciel, Dark Green, Dark Caramel, Grey, Light Grey, Mink, Matrine, Petrol, Stone, Taupe, Tile

FIBER SOFT ARMCHAIR

“One of the foremost principles of design is to create simple and well-functioning, almost ordinary objects that nevertheless have a strong identity. We designed the Fiber Soft Armchair to do just that. The chair’s sculptural language, paired with a wide and ultra-soft seat, refuses to compromise on comfort and invites the user to be seated for hours on end. With soft wadding and upholstery, the Fiber Soft Armchair enhances the idea of grand comfort. The chair’s inner shell is made using recycled plastic for a conscious and innovative perspective on materials.”

— Iskos-Berlin



Designed by	Iskos-Berlin
Environment	Indoor
Country of Production	Poland
Assembly Required	No
Description	A sculptural yet distinctly ergonomic seat makes the Fiber Soft Armchair ideal anywhere we spend an extended time seated. Its interior shell, made of recycled plastic, is clad with soft wadding and upholstery to elevate a supreme sense of ease and embrace. The spacious, ultra-soft seat and smooth curves of the Fiber Soft Armchair provide maximum comfort in public spaces and the home.
Material	<p>Shell from 100% recycled plastic mixed with strength-improving additives. The recycled plastic comes from post-consumer waste. The seat, back, and armrest are clad with multiple layers of foam and wadding and finished with textile, imitation leather, or leather upholstery. Leather from selected premium leather suppliers.</p> <p>Wood base in FSC™-certified (FSC-CO28824) oak with water-based lacquer. For Stained Dark Brown version only: Please note that slight color variations can occur due to the inherent characteristics of the material. Plastic glides.</p> <p>Tube base in powder coated steel. Plastic glides.</p> <p>Swivel base in aluminum. Cylinder in steel. Castors.</p>
Cleaning & Care	<p>Textile: For textile upholstered versions: In case of stains, we generally recommend removing non-greasy stains by carefully dabbing with a lint-free cloth or sponge wrung out in clean, warm water. If necessary, clean by dabbing with soapy water made with a bit of dish soap. Finally, dab the surface with clean water. We highly recommend that you go to kvadrat.dk for further cleaning and maintenance instructions for your chosen textile, as the cleaning methods may vary from one textile to another.</p> <p>Imitation Leather: Clean with lukewarm PH-neutral, soapy water and a soft cloth or soft brush. Do not use solvents or chemical cleaners, but cleaning can be done with alcohol-based cleaners. Finally, wipe with a damp cloth.</p> <p>Leather: As a natural material, leather requires looking after. If you care for the leather correctly, it will become even more beautiful over time.</p> <p>Refine Leather, Easy Leather, and Endure Leather: Clean leather with a dry cloth regularly. Treat the leather at least four times a year using only special leather treatment products. Visit ca-mo.com for further information on cleaning leather.</p> <p>Allure and Grace Leather: Only vacuum clean with a soft brush. Never use soap or water otherwise, the velvety look and feel will disappear. Do not apply leather grease or soak the leather. Avoid chemical products like saddle soap, leather cleaners, or household products.</p> <p>Base: Clean with a moist cloth. If necessary, use a little dish soap on the cloth.</p>

CUSTOMIZED UPHOLSTERY

Textile Upholstery: 2 m / 2.2 yds — Leather Upholstery: 3,2 m² / 34.5 ft²

TESTS & CERTIFICATIONS

EN 16139:2013 - L2

Extreme use Furniture - Strength, durability and safety.
Requirements for non-domestic seating.

EN 1022:2005 - L2

Extreme use Domestic furniture - Seating - Determination of stability.

ANSI/BIFMA X5.4-2020

American National Standard For Office Furnishings.
Lounge and Public Seating.

VOC CDPH 01350 &
VOC BIFMA X7.1.

Fiber Soft Armchair upholstered with Easy, Refine or Grace Leather or a large selection of Kvadrat textiles¹ are tested to VOC CDPH 01350 and VOC BIFMA X7.1.

¹Upholstered Muuto products that are tested to VOC CDPH 01350 and VOC BIFMA X7.1. are only compliant when upholstered with the following Kvadrat textiles: Balder, Canvas, Clara, Clay, Divina, Divina MD, Divina mélange, Fiord, Hallingdal, Hero, Remix, Re-wool, Steelcut, Steelcut Trio, Vidar, Twill weave.

Forest Stewardship Council™

Wood Base made in FSC™-certified (FSC-CO28824) wood.

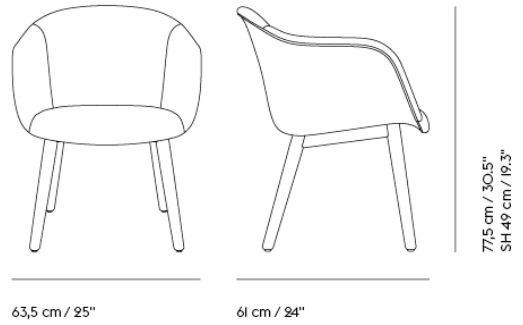

Gross Weight (kg) 15.632
Net Weight (kg) 12.132
Base color options Oak, Stained Dark Brown, Anthracite Black or Grey
Warranty period 10 years

Pattern No.	Color	Contract Price	Lead Time
Ready-To-Ship EU Warehouse			
MFIBSOFAWODU-OAK-M10767240	Ecriture 240/Oak	USD 1,626.00	-
Extras			
80161	Black	USD 21.00	-
80196	Felt Glides for Fiber Conference Wood Base - 4 Pcs.	USD 21.00	-
MGLDFWDFB4	Felt Glides for Fiber Wood Base (4 pcs per pack) - Black	USD 21.00	-
MGLDFWDFG4	Felt Glides for Fiber Wood Base (4 pcs per pack) - Grey	USD 21.00	-
80151	Grey	USD 21.00	-
MLEAKIT	Leather care set for Refine Leather	USD 27.00	-

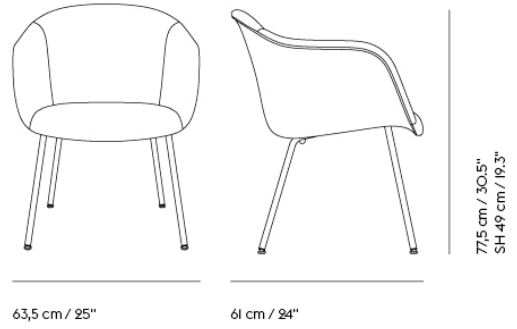

Gross Weight (kg)	15.117
Net Weight (kg)	19.5
Base color options	Anthracite Black or Grey
Warranty period	10 years

Pattern No.	Color	Contract Price	Lead Time
Ready-To-Ship US Warehouse			
MFIBSOFATUBU-GREY-M10767240	Ecriture 240/Grey	USD 1,465.00	-
Extras			
80175	Black	USD 6.00	-
80172	Dusty Green	USD 6.00	-
80173	Grey	USD 6.00	-
80195	Felt Glides for Fiber Conference Tube Base - 4 Pcs.	USD 21.00	-
MGLDOFVTBFB4	Felt Glides for Oslo, Fiber and Visu with Tube Base (4 pcs per pack)	USD 21.00	-
MLEAKIT	Leather care set for Refine Leather	USD 27.00	-

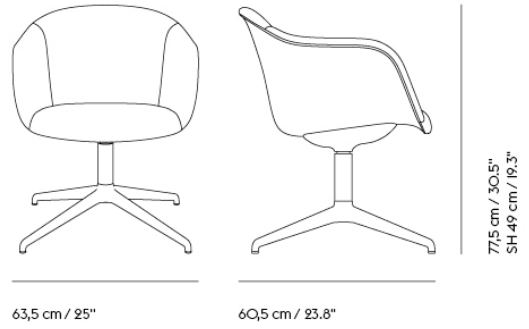

Gross Weight (kg) 17.305
Net Weight (kg) 13.805
Base color options Anthracite Black or Grey
Warranty period 10 years

Pattern No.	Color	Contract Price	Lead Time
Ready-To-Ship US Warehouse			
MFIBSOFASWBU-GREY-M10767240	Ecriture 240/Grey	USD 1,626.00	-
Extras			
MGLDFVSWFB4	Felt Glides for Fiber and Visu with Swivel Base (4 pcs per pack)	USD 21.00	-
MLEAKIT	Leather care set for Refine Leather	USD 27.00	-

FIBER SOFT ARMCHAIR SWIVEL BASE



Swivel Base & w. Return

Shipper Colli 1	1
Gross Weight (Kg)	19.5
Warranty period	10 years

Swivel Base w. Return & Tilt

Shipper Colli 1	1
Gross Weight (Kg)	19.5
Warranty period	10 years

Swivel Base w. Castors

Shipper Colli 1	1
Gross Weight (Kg)	19.5
Warranty period	10 years

Swivel Base w. Castors & Tilt

Shipper Colli 1	1
Gross Weight (Kg)	19.5
Warranty period	10 years

Swivel Base w. Gas Lift, Castors, and Tilt

Shipper Colli 1	1
Gross Weight (Kg)	19.5
Warranty period	10 years

All Variants

FIBER SOFT - SWIVEL BASE



FIBER SOFT - SWIVEL BASE W. RETURN



FIBER SOFT - SWIVEL BASE W. RETURN & TILT



FIBER SOFT - SWIVEL BASE W. CASTORS



FIBER SOFT - SWIVEL BASE W. CASTORS AND TILT



FIBER SOFT - SWIVEL BASE W. CASTORS AND TILT AND GASLIFT



FIBER SOFT ARMCHAIR SWIVEL BASE

All Variants

All Variants	Description	Pattern No.	Upholstery Grades								
			A	B	CIL	E	R	T	COL	U	V
Fiber Soft Armchair Swivel Base	Upholstered Shell	MFIBSOFASWBU	1,311	1,465	1,626	1,626	1,941	2,046	2,095	2,410	2,571
Fiber Soft Armchair Swivel Base w. Return	Upholstered Shell	MFIBSOFASWRU	1,360	1,521	1,626	1,675	1,990	2,095	2,151	2,515	2,620
Fiber Soft Armchair Swivel Base w. Return & Tilt	Upholstered Shell	MFIBSOFASWTU	1,416	1,570	1,626	1,731	2,095	2,151	2,256	2,571	2,676
Fiber Soft Armchair Swivel Base w. Castors	Upholstered Shell	MFIBSOFASWCU	1,311	1,465	1,626	1,675	1,941	2,095	2,151	2,515	2,620
Fiber Soft Armchair Swivel Base w. Castors & Tilt	Upholstered Shell	MFIBSOFASWCTU	1,416	1,626	1,731	1,731	2,095	2,151	2,256	2,571	2,676
Fiber Soft Armchair Swivel Base w. Castors & Gas Lift, and Tilt	Upholstered Shell	MFIBSOFASWGTU	1,465	1,675	1,731	1,836	2,095	2,256	2,305	2,620	2,781

HOW TO CONFIGURE

ORDER CODE EXAMPLE: Upholstered Shell

Upholstered Shell

- Step 1) Choose variant
- Step 2) Choose base color
- Step 3) Choose upholstery
- Step 4) Choose upholstery color

Fiber Soft Armchair Swivel Base with Castors, Gas Lift, and Tilt in Twill Weave 230

Variant
Base color
Upholstery
Upholstery color
Final Pattern No:

Castors, Gaslift, & Tilt - upholstered
Anthracite Black
Twill Weave
230
MFIBSOFASWGTU^BBLCKM142230

Base Color Options

- BLCK - Anthracite Black
- GREY - Grey

Upholstery Options

A	B	C	E	R	T	U	V	W
Ocean (M161)*	Cameo (K1443)	Hallingdal (M146)	Acca (M12660)	Easy Leather (M141)	Refine Leather (M136)	Endure Leather (M137)	Grace Leather (M12374)	Allure Leather (M12375)
Remix (M156)	Canvas (M153)	Illusion (M12654)	Aegean (K2074)					
Wooly (M159)	Clara (M154)		Balder (M152)			Volo Leather (VO)		
	Fiord (M155)		Beck (M6376)					
	Hero (M164)		Divina (M150)					
	Grain (M12659)		Divina MD (M147)					
	Knoll Hopsack (K1206)		Divina Melange (M135)					
	Manner (M12665)		Ecriture (M10767)					
	Prairie (K1925)		Hearth (M12664)					
	Re-Wool (M4586)		Planum (M5904)					
	Sabi (M8404)		Twill Weave (M142)					
	Steelcut (M149)		Vidar (M158)					
	Steelcut Quartet (M13042)							
	Steelcut Trio (M139)							
	Vibe II (K2154)							

*Notes:
Ocean - Color 3, 21, 32, 50, 52, 80 & 601
Illusion - Black, Blue, Caribou, Chocolate, Ciel, Dark Green, Dark Caramel, Grey, Light Grey, Mink, Matrine, Petrol, Stone, Taupe, Tile

FIBER SOFT ARMCHAIR WOOD & TUBE BASE



FIBER SOFT -
TUBE BASE



91 cm /
35.8"
SH 44.5 cm / 17.5"

81 cm / 31.9" 91.3 cm / 35.9"

Tube Base
Shipper Colli: 1
Gross Weight (kg): 22.9
Net Weight (kg): 19.5
Warranty Period: 10 years

FIBER SOFT -
WOOD BASE

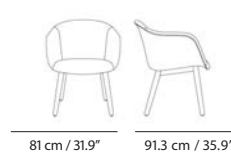

91 cm /
35.8"
SH 44.5 cm / 17.5"

81 cm / 31.9" 91.3 cm / 35.9"

Wood Base
Shipper Colli: 1
Gross Weight (kg): 22.9
Net Weight (kg): 19.5
Warranty Period: 10 years

All Variants

All Variants	Description	Pattern No.	Uphol- stery Grades		COM		CIL		COL		
			A	B	C	E	R	T	U	V	W
Fiber Soft Armchair Wood Base	Upholstered Shell	MFIBSOFAWODU	1,311	1,465	1,570	1,626	1,941	2,046	2,095	2,466	2,466
Fiber Soft Armchair Tube	Upholstered Shell	MFIBSOFATUBU	1,206	1,360	1,465	1,465	1,885	1,941	1,990	2,410	2,410

HOW TO CONFIGURE

ORDER CODE EXAMPLE: Upholstered Shell

Upholstered Shell

Fiber Soft Armchair Wood Base Ocean 80

- Step 1) Choose variant
- Step 2) Choose base color
- Step 3) Choose upholstery
- Step 4) Choose upholstery color

Variant
Base color
Upholstery
Upholstery color
Final Pattern No:

Fiber Soft Armchair Wood Base - Upholstered Oak
Ocean
80
MFIBSOFAWODU-OAK-M16180

OAK
M161
80

BASE COLOR OPTIONS

Tube Base:

BLCK - Black

GREY - Grey

Wood base:

OAK - Oak

STDB - Stained Dark

Brown

BLCK - Black

GREY - Grey

Upholstery Options

A	B	C	E	R	T	U	V	W
Ocean (M161)*	Cameo (K1443)	Hallingdal (M146)	Acca (M12660)	Easy Leather (M141)	Refine Leather (M136)	Endure	Grace	Allure
Remix (M156)	Canvas (M153)	Illusion (M12654)	Aegean (K2074)			Leather (M137)	Leather	Leather
Wooly (M159)	Clara (M154)		Balder (M152)			Volo Leather (VO)	(M12374)	(M12375)
	Fiord (M155)		Beck (M6376)					
	Hero (M164)		Divina (M150)					
	Grain (M12659)		Divina MD (M147)					
	Knoll Hopsack (K1206)		Divina Melange (M135)					
	Manner (M12665)		Ecriture (M10767)					
	Prairie (K1925)		Hearth (M12664)					
	Re-Wool (M4586)		Planum (M5904)					
	Sabi (M8404)		Twill Weave (M142)					
	Steelcut (M149)		Vidar (M158)					
	Steelcut Quartet (M13042)							
	Steelcut Trio (M139)							
	Vibe II (K2154)							

***Notes:**

Ocean - Color 3, 21, 32, 50, 52, 80 & 601
Illusion - Black, Blue, Caribou, Chocolate, Ciel, Dark Green,
Dark Caramel, Grey, Light Grey, Mink, Matrine, Petrol, Stone,
Taupe, Tile

FIBER CONFERENCE ARMCHAIR

"One of the most difficult and noble disciplines of design is to create simple, well-functioning and almost ordinary objects that nevertheless have a strong identity. We designed the Fiber Conference Armchair to do just that. The chair's sculptural language, paired with its wide seat, refuses to compromise on comfort and invites the user to be seated for hours on end. Through soft upholstery and the fixed cushion of its seat, the Fiber Conference armchair enhances the idea of grand comfort. The chair's inner shell is made using recycled plastic for a conscious and innovative perspective on materials."

— Iskos-Berlin



Designed by	Iskos-Berlin
Environment	Indoor
Country of Production	Poland
Assembly Required	No
Description	A sculptural yet distinctly ergonomic seat makes the Fiber Conference Armchair ideal anywhere we spend an extended time seated. Its interior shell is made using 100% recycled plastic, while its spacious seat and embracing curves are fully upholstered with a soft fixed cushion, providing maximum comfort in public spaces and the home alike.
Material	<p>Shell is made using 100% recycled plastic mixed with strength-improving additives. The recycled plastic comes from post-consumer waste. Fully upholstered in textile, imitation leather or leather.</p> <p>Base:</p> <p>Swivel Base w. or w.o. return: Swivel base in aluminum. Cylinder in steel. Plastic glides. Swivel Base w. return & tilt: Swivel base in aluminum. Cylinder in steel. Plastic glides. Swivel Base w. castors: Swivel base in aluminum. Cylinder in steel. Castors. Swivel Base w. tilt & castors: Swivel base in aluminum. Cylinder in steel. Castors. Swivel Base w. gas lift, tilt & castors: Swivel base in aluminum. Pressurized gas lift cylinder in steel. Castors. Tube base in powder coated steel. Plastic glides. Wood base in FSC™-certified (FSC-CO28824) oak or beech with water-based lacquer. Plastic glides. For Stained Dark Brown version only: Please note that slight color variations can occur due to the inherent characteristics of the material.</p>
Cleaning & Care	<p>Textile: For textile upholstered versions: In case of stains, we generally recommend removing non-greasy stains by carefully dabbing with a lint-free cloth or sponge wrung out in clean warm water. If necessary, clean by dabbing with soapy water made with a little dish soap. Finally, dab the surface with clean water. We highly recommend that you go to kvadrat.dk for further cleaning and maintenance instructions for your chosen textile, as the cleaning methods may vary from one textile to another.</p> <p>Imitation Leather: Clean with lukewarm PH-neutral soapy water and a soft cloth or soft brush. Do not use solvents or chemical cleaners, but cleaning can be done with alcohol-based cleaners. Finally, wipe with a damp cloth afterwards.</p> <p>Leather: As a natural material, leather requires looking after. If you care for the leather in the right way, it will become even more beautiful over time.</p> <p>Refine Leather, Easy Leather and Endure Leather: Clean leather with a dry cloth regularly, treat the leather at least four times a year using only special leather treatment products. Visit ca-mo.com further information on cleaning leather.</p> <p>Allure and Grace Leather: Only vacuum clean with a soft brush. Never use soap or water otherwise the velvety look and feel will disappear. Do not apply leather grease or soak the leather. Avoid any chemical products, such as saddle soap, leather cleaners or household products. Base: Clean with a moist cloth. If necessary, use a little dish soap on the cloth.</p>

CUSTOMIZED UPHOLSTERY

Textile Upholstery: 1,9 m / 2.1 yds — Leather Upholstery: 3,2 m² / 34.5 ft²

TESTS & CERTIFICATIONS

EN 16139:2013 - L2

Extreme use Furniture - Strength, durability and safety.
Requirements for non-domestic seating.

EN 1022:2005 - L2

Extreme use Domestic furniture - Seating - Determination of stability.

ANSI/BIFMA X5.4-2020

American National Standard For Office Furnishings.
Lounge and Public Seating.

VOC CDPH 01350 &
VOC BIFMA X7.1.

Fiber Conference Armchair upholstered with Easy, Refine or Grace Leather or a large selection of Kvadrat textiles¹ are tested to VOC CDPH 01350 and VOC BIFMA X7.1.

¹Upholstered Muuto products that are tested to VOC CDPH 01350 and VOC BIFMA X7.1 are only compliant when upholstered with the following Kvadrat textiles: Balder, Canvas, Clara, Clay, Divina, Divina MD, Divina mélange, Fiord, Hallingdal, Hero, Remix, Re-wool, Steelcut, Steelcut Trio, Vidar, Twill weave.

Forest Stewardship Council™

Fiber Conference with Wood Base is made using FSC™-certified (FSC-CO28824) wood.

FIBER CONFERENCE ARMCHAIR WOOD BASE



63,5 cm / 25"



61 cm / 24"

77,5 cm / 30.5"
SH: 49 cm / 19.3"

Shipper Colli	1
Gross Weight (kg)	15.63
Net Weight (kg)	12.132
Base color options	Anthracite Black, Grey, Oak and Stained Dark Brown
Warranty Period	10 years

Pattern No.	Color	Contract Price	Lead Time
Ready-To-Ship US Warehouse			
MFBCWODU-GREY-M156133	Remix I33/Grey	USD 1,311.00	-
MFBCWODU-OAK-M136COGN	Refine Leather Cognac/Oak	USD 2,046.00	-
Extras			
80193	Black	USD 21.00	-
80196	Felt Glides for Fiber Conference Wood Base - 4 Pcs.	USD 21.00	-
MGLDFWDFB4	Felt Glides for Fiber Wood Base (4 pcs per pack) - Black	USD 21.00	-
MGLDFWDFG4	Felt Glides for Fiber Wood Base (4 pcs per pack) - Grey	USD 21.00	-
80194	Grey	USD 21.00	-
MLEAKIT	Leather care set for Refine Leather	USD 27.00	-

FIBER CONFERENCE ARMCHAIR SWIVEL BASE



63,5 cm / 25"



60,5 cm / 23.8"

77,5 cm / 30.5"
SH 49 cm / 19.3"

Shipper Colli	1
Gross Weight (kg)	17.31
Net Weight (kg)	13.805
Base color options	Anthracite Black or Grey
Warranty period	10 years

Pattern No.	Color	Contract Price	Lead Time
Ready-To-Ship US Warehouse			
MFIBCSWBU-GREY-M156133	Remix I33/Grey	USD 1,311.00	-
MFIBCSWBU-BLCK-M136COGN	Refine Leather Cognac/Anthracite Black	USD 2,046.00	-
Extras			
80197	Black	USD 21.00	-
MGLDFVSWFB4	Felt Glides for Fiber and Visu with Swivel Base (4 pcs per pack)	USD 21.00	-
80198	Grey	USD 21.00	-
MLEAKIT	Leather care set for Refine Leather	USD 27.00	-

FIBER CONFERENCE ARMCHAIR SWIVEL BASE W. GAS LIFT, CASTORS AND TILT



70 cm / 27.6"



68 cm / 26.8"

SH 73-85 cm / 28.9-33.5"
SH 45-57 cm / 17.6-22.3"

Shipper Colli	1
Gross Weight (kg)	18.78
Net Weight (kg)	15.28
Base color options	Anthracite Black or Grey
Warranty period	10 years

Pattern No.	Color	Contract Price	Lead Time
Ready-To-Ship US Warehouse			
MFIBCSWGTU-GREY-M156133	Remix I33/Grey	USD 1,521.00	-
MFIBCSWGTU-BLCK-M136COGN	Refine Leather Cognac/Anthracite Black	USD 2,256.00	-
Extras			
MLEAKIT	Leather care set for Refine Leather	USD 27.00	-

FIBER CONFERENCE ARMCHAIR SWIVEL BASE



Swivel Base & w. Return

Shipper Colli 1	1
Gross Weight (Kg)	19.5
Warranty period	10 years

Swivel Base w. Return & Tilt

Shipper Colli 1	1
Gross Weight (Kg)	19.5
Warranty period	10 years

Swivel Base w. Castors

Shipper Colli 1	1
Gross Weight (Kg)	19.5
Warranty period	10 years

Swivel Base w. Castors & Tilt

Shipper Colli 1	1
Gross Weight (Kg)	19.5
Warranty period	10 years

Swivel Base w. Gas Lift, Castors, and Tilt

Shipper Colli 1	1
Gross Weight (Kg)	19.5
Warranty period	10 years

All Variants

FIBER CONFERENCE - SWIVEL BASE

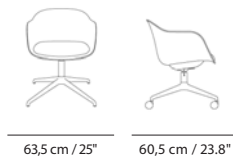

77.5 cm / 30.5"
SH 49cm / 19.3"

FIBER CONFERENCE - SWIVEL BASE W. RETURN

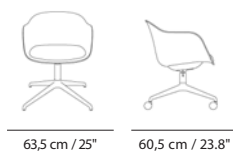

77.5 cm / 30.5"
SH 49cm / 19.3"

FIBER CONFERENCE - SWIVEL BASE W. RETURN & TILT

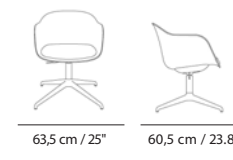

77.5 cm / 30.5"
SH 49cm / 19.3"

FIBER CONFERENCE - SWIVEL BASE W. CASTORS



77.5 cm / 30.5"
SH 49cm / 19.3"

FIBER CONFERENCE - SWIVEL BASE W. CASTORS AND TILT

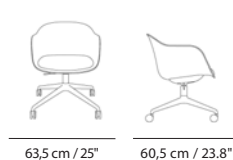

77.5 cm / 30.5"
SH 49cm / 19.3"

FIBER CONFERENCE - SWIVEL BASE W. CASTORS AND TILT AND GASLIFT

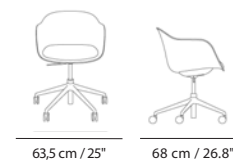

73.85 cm / 28.9-33.5"
SH 45-57cm / 17.6-22.22"

FIBER CONFERENCE ARMCHAIR SWIVEL BASE

All Variants

All Variants	Description	Pattern No.	Upholstery Grades		COM							
			A	B	C	E	R	T	COL			
Fiber Conference Armchair Swivel Base	Upholstered Shell	MFIBCSWBU	1,311	1,465	1,626	1,626	1,941	2,046	2,095	2,410	2,571	
Fiber Conference Armchair Swivel Base w. Return	Upholstered Shell	MFIBCSWRU	1,360	1,521	1,626	1,675	1,990	2,095	2,151	2,515	2,620	
Fiber Conference Armchair Swivel Base w. Return & Tilt	Upholstered Shell	MFIBCSWTU	1,465	1,626	1,570	1,780	2,095	2,200	2,256	2,571	2,781	
Fiber Conference Armchair Swivel Base w. Castors	Upholstered Shell	MFIBCSWCU	1,360	1,521	1,626	1,675	1,990	2,095	2,151	2,515	2,620	
Fiber Conference Armchair Swivel Base w. Castors & Tilt	Upholstered Shell	MFIBCSWCTU	1,465	1,626	1,731	1,780	2,095	2,200	2,256	2,571	2,781	
Fiber Conference Armchair Swivel Base w. Castors & Gas Lift, and Tilt	Upholstered Shell	MFIBCSWGTU	1,521	1,675	1,731	1,836	2,151	2,256	2,305	2,620	2,781	

HOW TO CONFIGURE

ORDER CODE EXAMPLE: Upholstered Shell

Upholstered Shell	Fiber Conference Armchair Swivel Base with Castors, Gas Lift, and Tilt in Twill Weave 230	
Step 1) Choose variant	Variant	Castors, Gaslift, & Tilt - upholstered
Step 2) Choose base color	Base color	Anthracite Black
Step 3) Choose upholstery	Upholstery	Twill Weave
Step 4) Choose upholstery color	Upholstery color	230
	Final Pattern No:	MFIBCSWGTUBLCKM142230

Base Color Options

- BLCK - Anthracite Black
- GREY - Grey

Upholstery Options

A	B	C	E	R	T	U	V	W
Ocean (M161)*	Cameo (K1443)	Hallingdal (M146)	Acca (M12660)	Easy Leather (M141)	Refine Leather (M136)	Endure Leather (M137)	Grace Leather (M12374)	Allure Leather (M12375)
Remix (M156)	Canvas (M153)	Illusion (M12654)	Aegean (K2074)			Volo Leather (VO)		
Wooly (M159)	Clara (M154)		Balder (M152)					
	Fiord (M155)		Beck (M6376)					
	Hero (M164)		Divina (M150)					
	Grain (M12659)		Divina MD (M147)					
	Knoll Hopsack (K1206)		Divina Melange (M135)					
	Manner (M12665)		Ecriture (M10767)					
	Prairie (K1925)		Hearth (M12664)					
	Re-Wool (M4586)		Planum (M5904)					
	Sabi (M8404)		Twill Weave (M142)					
	Steelcut (M149)		Vidar (M158)					
	Steelcut Quartet (M13042)							
	Steelcut Trio (M139)							
	Vibe II (K2154)							

*Notes:
 Ocean - Color 3, 21, 32, 50, 52, 80 & 601
 Illusion - Black, Blue, Caribou, Chocolate, Ciel, Dark Green, Dark Caramel, Grey, Light Grey, Mink, Matrine, Petrol, Stone, Taupe, Tile

FIBER CONFERENCE ARMCHAIR WOOD & TUBE BASE



FIBER CONFERENCE -
TUBE BASE

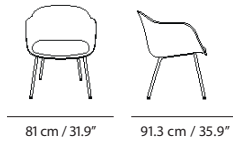

Tube Base
Shipper Colli: 1
Gross Weight (kg): 22.9
Net Weight (kg): 19.5
Warranty Period: 10 years

FIBER CONFERENCE -
WOOD BASE

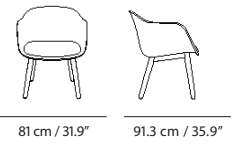

Wood Base
Shipper Colli: 1
Gross Weight (kg): 22.9
Net Weight (kg): 19.5
Warranty Period: 10 years

All Variants

All Variants	Description	Pattern No.	Upholstery Grades								
			A	B	COM	CIL	R	T	COL	U	V
Fiber Conference Armchair Wood Base	Upholstered Shell	MFIBCWODU	1,311	1,465	1,570	1,626	1,941	2,046	2,095	2,410	2,571
Fiber Conference Armchair Tube	Upholstered Shell	MFIBCTUBU	1,206	1,360	1,465	1,465	1,885	1,941	1,990	2,361	2,515

HOW TO CONFIGURE

ORDER CODE EXAMPLE: Upholstered Shell

Upholstered Shell

- Step 1) Choose variant
- Step 2) Choose base color
- Step 3) Choose upholstery
- Step 4) Choose upholstery color

Fiber Conference Armchair Wood Base Ocean 80

Variant: Fiber Conference Armchair Wood Base - Upholstered
 Base color: Oak
 Upholstery: Ocean
 Upholstery color: 80
 Final Pattern No: MFIBCWODU-OAK-M16180

BASE COLOR OPTIONS

Tube Base:
BLCK - Black

GREY - Grey

Wood base:
OAK - Oak
STDB - Stained Dark
Brown
BLCK - Black
GREY - Grey

Upholstery Options

A	B	C	E	R	T	U	V	W
Ocean (M161)*	Cameo (K1443)	Hallingdal (M146)	Acca (M12660)	Easy Leather (M141)	Refine Leather (M136)	Endure	Grace	Allure
Remix (M156)	Canvas (M153)	Illusion (M12654)	Aegean (K2074)			Leather (M137)	Leather	Leather
Wooly (M159)	Clara (M154)		Balder (M152)			Volo Leather (VO)	(M12374)	(M12375)
	Fiord (M155)		Beck (M6376)					
	Hero (M164)		Divina (M150)					
	Grain (M12659)		Divina MD (M147)					
	Knoll Hopsack (K1206)		Divina Melange (M135)					
	Manner (M12665)		Ecriture (M10767)					
	Prairie (K1925)		Hearth (M12664)					
	Re-Wool (M4586)		Planum (M5904)					
	Sabi (M8404)		Twill Weave (M142)					
	Steelcut (M149)		Vidar (M158)					
	Steelcut Quartet (M13042)							
	Steelcut Trio (M139)							
	Vibe II (K2154)							

***Notes:**

Ocean - Color 3, 21, 32, 50, 52, 80 & 601
 Illusion - Black, Blue, Caribou, Chocolate, Ciel, Dark Green,
 Dark Caramel, Grey, Light Grey, Mink, Matrine, Petrol, Stone,
 Taupe, Tile

FIBER OUTDOOR SERIES

“One of the most difficult and noble disciplines of design is to create simple, functional and almost ordinary objects that nevertheless have a strong identity. The Fiber Outdoor Armchair combines simple, embracing curves and a clear sculptural form manufactured using innovative materials, with a shell made from a minimum of 100% recycled plastic. In molding the chair’s shell, waste plastic is processed into high-quality granulates, creating a new take on modern outdoor furniture.”

— Iskos Berlin



Designed by	Iskos Berlin
Environment	Outdoor
Country of Production	Poland
Assembly Required	No
Description	<p>The Fiber Outdoor Armchair brings a new perspective on modern outdoor furniture, with an innovative shell material made of 100% recycled plastic. With each chair, a minimum of 4,2 kg of plastic waste is given new life. UV stabilizers are added to the shell’s composite, protecting the color of the chair from the wear and tear of outside life. The Fiber Outdoor Armchair’s friendly, embracing curves provide extensive comfort with a functional and durable design.</p> <p>The Fiber Outdoor Side Chair brings a new perspective on modern outdoor furniture, with an innovative shell material made of 100% recycled plastic. With each chair, a minimum of 2,5 kg of plastic waste is given new life. UV stabilizers are added to the shell’s composite, protecting the color of the chair from the wear and tear of outside life. The Fiber Outdoor Side Chair’s friendly, embracing curves provide extensive comfort with a functional and durable design.</p>
Material	Made using 100% recycled plastic mixed with UV stabilizers that keep color-fading at a minimum, protecting it from the impact of the sun. Tube base in galvanized steel with a weather-resistant deep matte powder coating. Plastic glides for outdoor use.
Cleaning & Care	<p>When cared for properly, the Fiber Outdoor chair is designed to last. Follow these simple rules to care for your design in the best possible way. Clean the chair with a damp cloth. If necessary, use a mild detergent or dish-washing liquid, not concentrated. Always wipe with a dry cloth afterwards. To minimize the risk of stains and marks, liquids, grease etc. should be removed straight away. Lacquered surfaces can get scratches and chips if hit by other hard objects.</p> <p>To protect the chair from weather’s harm when not in use, a cover suitable for a table with 6 chairs can be purchased separately. Please make sure that both the table, chairs and the inside of the cover is completely dry before putting the cover on. It is recommended to use a cover to protect the furniture from weather’s harm, especially during the winter season.</p>
Color Codes:	<p>Anthracite Black: RAL 7021 Grey: RAL 7044 Dusty Green: RAL 7033 Brown Red: RAL 8017</p>

	TESTS & CERTIFICATIONS
ANSI/BIFMA X5.4-2020	American National Standard For Office Furnishings. Lounge and Public Seating.
EN 581-1:2017	Outdoor Furniture-General safety for domestic and contract.
EN 581-2:2017	Outdoor Furniture-Mechanical safety for domestic and contract.
EN 16139:2013 - L2	Extreme use Furniture - Strength, durability and safety. Requirements for non-domestic seating.
EU Ecolabel	The Fiber Outdoor Armchair and Side Chair is EU Ecolabel Certified. By carrying the EU Ecolabel Certification, the product is guaranteed to have a reduced environmental impact throughout the total lifecycle of the product from raw material to disposal.
VOC CDPH 01350 & VOC BIFMA X7.1.	Fiber Outdoor Armchair and Side Chair are VOC CDPH 01350 and VOC BIFMA X7.1 tested.

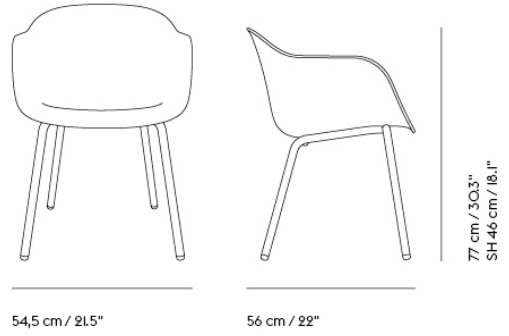

Shipper Colli 1
 Gross Weight (kg) 5.5
 Net Weight (kg) 6.5
 Warranty Period 10 years

Pattern No.	Color	Contract Price	Lead Time
Ready-To-Ship US Warehouse			
MFIBOATUB-BLCK	Anthracite Black	USD 415.00	-
MFIBOATUB-BRRD	Brown Red	USD 415.00	-
MFIBOATUB-DGRN	Dusty Green	USD 415.00	-
MFIBOSTUB-GREY	Grey	USD 415.00	-

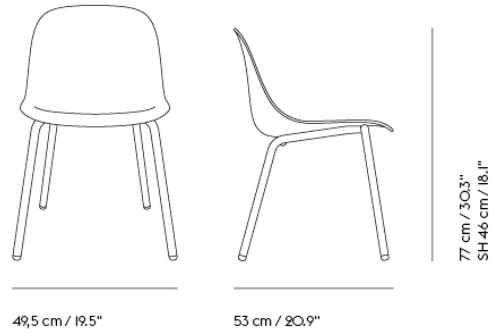

Shipper Colli |
 Gross Weight (kg) 4.5
 Net Weight (kg) 4.9
 Warranty Period 10 years

Pattern No.	Color	Contract Price	Lead Time
Ready-To-Ship US Warehouse			
MFIBOSTUB-BLCK	Anthracite Black	USD 383.00	-
MFIBOSTUB-BRRD	Brown Red	USD 383.00	-
MFIBOSTUB-DGRN	Dusty Green	USD 383.00	-
MFIBOSTUB-GREY	Grey	USD 383.00	-

FIVE POUF

"The Five Pouf explores the possibility and tension of the pentagon shape. The design process was very much about tailoring; the quilted ribs are seemingly wrapped around the shape and enhance the dynamics of the pentagon. The quilting adds a softness to the seat, and the textiles we have chosen are very responsive to the undulating surface of the cover."

— Anderssen & Voll



Designed by	Anderssen & Voll
Environment	Indoor
Country of Production	Lithuania
Assembly Required	No
Description	The Five Pouf is a versatile, easy-to-use design that is both comfortable and contemporary. With a pentagon shape and linear detailing contrasted against curved edges, the Five Pouf is a unique item that can be used as extra seating or to decorate an unused corner of any room.
Material	Wooden frame, wooden feet, moulded foam and upholstered with textile.
Cleaning & Care	Remove non-greasy stains by carefully dabbing with a lint-free cloth or sponge wrung out in clean warm water. If necessary, clean by dabbing with soapy water with a little dish soap. Finally, dab the surface with clean water. See kvadrat.dk for further cleaning and maintenance instructions for your chosen textile.
Large	CUSTOMIZED UPHOLSTERY Textile upholstery: 3 m / 3.3 yds
Extra Large	Textile upholstery: 5,4 m / 5.9 yds
	TESTS & CERTIFICATIONS
EN 16139:2013 - L2	Extreme use. Furniture - Strength, durability and safety. Requirements for non-domestic seating.
EN 1022:2005	Extreme use. Domestic furniture - Seating - Determination of stability.
ANSI/BIFMA X5.4-2012	American National Standard For Office Furnishings. Lounge and Public Seating.
VOC CDPH 01350 & VOC BIFMA X7.1.	Five Pouf in EU/US versions upholstered with a large selection of Kvadrat textiles ¹ are tested to VOC CDPH 01350 and VOC BIFMA X7.1.

¹Upholstered Muuto products that are tested to VOC CDPH 01350 and VOC BIFMA X7.1. are only compliant when upholstered with the following Kvadrat textiles: Balder, Canvas, Clara, Clay, Divina, Divina MD, Divina mélange, Fiord, Hallingdal, Hero, Remix, Re-wool, Steelcut, Steelcut Trio, Vidar, Twill weave.

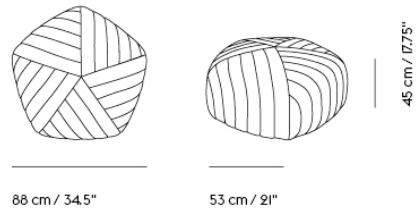

Shipper Colli 1
Gross Weight (kg) 22
Net Weight (kg) 18.8
Warranty Period 10 years

Pattern No.	Color	Contract Price	Lead Time
Ready-To-Ship US Warehouse			
MFIVEPLG-M156123	Remix I23 ***	USD 1,570.00	-
MFIVEPLG-M156183	Remix I83 ***	USD 1,570.00	-
MFIVEPLG-M139205	Steelcut Trio 205	USD 1,836.00	-

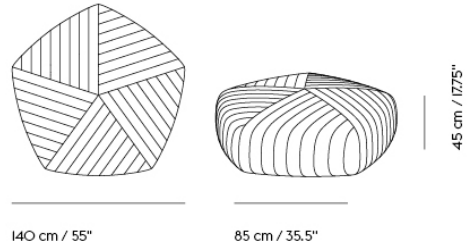

Shipper Colli 1
Gross Weight (kg) 56
Net Weight (kg) 41
Warranty Period 10 years

Pattern No.	Color	Contract Price	Lead Time
Ready-To-Ship US Warehouse			
MFIVEPXL-M156123	Remix 123	USD 3,306.00	-
MFIVEPXL-M156183	Remix 183	USD 3,306.00	-
MFIVEPXL-M156632	Remix 632 ***	USD 3,306.00	-
MFIVEPXL-M156773	Remix 773 ***	USD 3,306.00	-
MFIVEPXL-M156933	Remix 933 ***	USD 3,306.00	-
MFIVEPXL-M139205	Steelcut Trio 205	USD 3,516.00	-



All Variants

		Upholstery Grades			
		A	COM	CIL	E
Pattern No.		A	B	C	E
Large	M-FIVEP-LG	1,570	1,836	2,095	2,151
Extra Large	M-FIVEP-XL	3,306	3,516	3,831	4,146

HOWTO CONFIGURE

Five Pouf

Specify:

- Step 1) Choose Size
- Step 2) Choose textile
- Step 3) Choose textile color

ORDER CODE EXAMPLE:
Upholstered Shell

Five Pouf XL in Remix 133

Size	Five Pouf Extra Large	MFIVEPXL
Textile	Remix	M156
Textile Color	133	133
Final Pattern No:	MFIVEPXL156133	

Upholstery Options

A	B	E
Remix (M156)	<ul style="list-style-type: none"> Canvas (M153) Fiord (M155) Grain (M12659) Manner (M12665) Re-Wool (M4586) Sabi (M8404) Steelcut (M149) Steelcut Trio (M139) 	<ul style="list-style-type: none"> Acca (M12660) Beck (M6376) Divina (M150) Divina MD (M147) Divina Melange (M135) Ecriture (M10767) Hearth (M12664) Planum (M5904) Twill Weave (M142)

FLOW TROLLEY

“With the Flow Trolley, we wanted to create a versatile design that could be used in any setting, be it at home, in the workplace or in a hotel room. With its grooved trays in embossed metal that make for an understated vibrancy, the Flow Trolley adds a contemporarily elegant touch to a traditional form while bringing simple functionality into everyday life.”

— Normal Studio



Designed by	Normal Studio
Environment	Indoor
Country of Production	China
Assembly Required	Yes
Description	The Flow Trolley brings the concept of functional design into a modern context through its grooved trays in embossed metal for a contemporary expression, paired with the flexibility of its wheels that allows for it to be moved from one room into the other. Designed in a monochrome look, the Flow Trolley adds modern storage to any space in the home, workplace or hospitality setting.
Material	Trays and legs in powder coated steel. Wheels in powder coated steel and rubber.
Cleaning & Care	Clean with a moist cloth. If necessary use a little dish soap on the cloth.

TESTS & CERTIFICATIONS

EN 15372:2016 - L2	General Use. Strength, durability and safety. Requirements for nondomestic tables.
--------------------	--

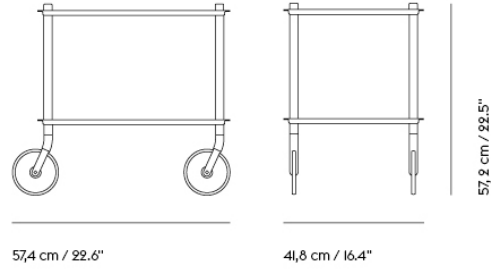

Shipper Colli 1
Gross Weight (kg) 15.2
Net Weight (kg) 12.7
Warranty Period 5 years

Pattern No.	Color	Contract Price	Lead Time
Ready-To-Ship US Warehouse			
MFT2L-BUGY	Blue-Grey	USD 671.00	-
MFT2L-GREY	Grey	USD 671.00	-

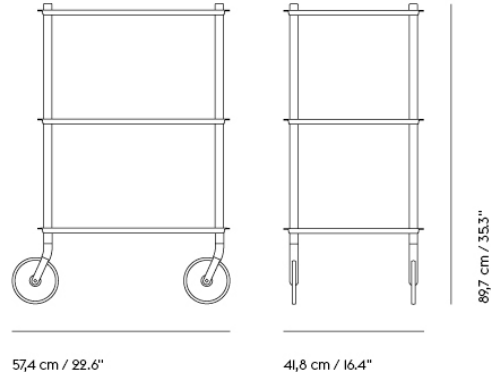

Shipper Colli 2
Gross Weight (kg) 22.4
Net Weight (kg) 18.5
Warranty Period 5 years

Pattern No.	Color	Contract Price	Lead Time
Ready-To-Ship US Warehouse			
MFT3L-BUGY	Blue-Grey	USD 902.00	-
MFT3L-GREY	Grey	USD 902.00	-

HALVES SIDE TABLE

"The Halves table is youthful and informal in its aesthetics, but represents more traditional values of durability and practicality simultaneously. We were inspired by the unique properties of the solid surface material which led to the specific exploration of form with an emphasis on planes and intersections. We further wanted to pursue a form that was practical, yet somewhat abstract, and therefore played with asymmetry: Halves presents different aspects of itself over time, depending on the position of the observer."

— MSDS Studio

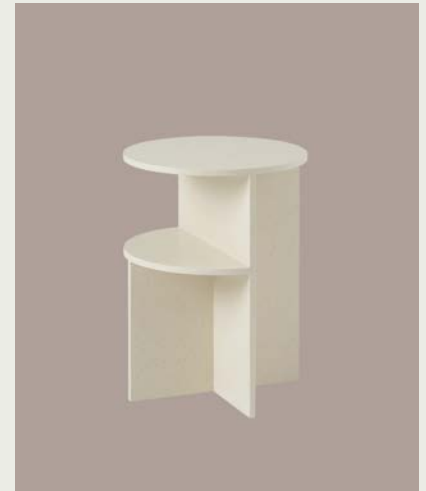

Designed by	MSDS Studio
Environment	Indoor
Country of Production	China
Preassembled	Yes
Description	Made from a unique combination of acrylic and stone, the Halves Side Table is a sculptural display table that is a fit for any setting; next to the bed or sofa, in a hallway or an office. With its intersecting planes and contemporary shapes, the expression of the Halves Side Tables change according to the perception of its viewer.
Material	Made from large casted sheets of acrylic stone composite that are cut into shapes and welded together. Lastly, the surfaces are grinded and polished giving the side table its soft feel and seamless joints.
Cleaning & Care	Please use a wet cloth to clean surface if coffee, tea or other liquids are spilled on the table surface. If the stain cannot be removed with a wet cloth, we suggest using a small amount of normal detergent together with the wet cloth. If the stain is not immediately removed upon having been made and unable to remove after, we suggest using #800—1200 grit sanding paper to manually polish the surface. It is highly recommended to re-apply stone sealer 1-2 times a year on the tabletop surface in order to upkeep its stain-protection. Stone sealer can be purchased in your local hardware store.
EN 15372:2016 - L3	<p>TESTS & CERTIFICATIONS</p> <p>Extreme use. Furniture - Strength, durability and safety. Requirements for non-domestic tables.</p>

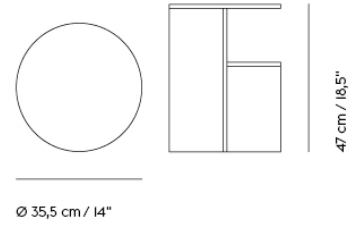

Shipper Colli 1
Gross Weight (kg) 11.4
Net Weight (kg) 10
Warranty Period 5 years

Pattern No.	Color	Contract Price	Lead Time
Ready-To-Ship US Warehouse			
MHLVST-LTGY	Light Grey	USD 614.00	-
MHLVST-SAGN	Sage Green ***	USD 614.00	-
MHLVST-SAND	Sand ***	USD 614.00	-

IN SITU MODULAR SOFA

"With the In Situ Modular Sofa, we wanted to combine the functions of modularity with the beauty of simple, elegant lines and a deep comfort. We sketched a profile that runs along the seat and back of the sofa to subtly hide the visual elements of modularity, giving it a unique character while bringing the individual modules together for a complete appearance. This is paired with grand, sculptural lines and the inherent comfort of its soft seat. The In Situ Modular Sofa combines the grandeur of traditional Italian sofas with the refined simplicity of Scandinavian design, making it the heart of any space."

— Anderssen & Voll



Designed by	Anderssen & Voll
Environment	Indoor
Country of Production	Lithuania
Assembly Required	Yes - Assemble frame sections and mount seating modules on assembled frame sections
Description	<p>The In Situ Modular Sofa is a grand, modular design with sculptural lines that can be tailored to your individual space and taste with its modular elements hidden through subtle detailing of its front profile, paired with deep comfort and a soft seat. Choose from any of the 30 pre-designed configurations or create your own, using the 9 different seating modules and loose cushions. The look and feel of the In Situ Modular Sofa is more casual in its appearance, compared to some of our other sofas. Visit our Product Planner to explore the possible configurations: planner.muuto.com/in-situ *Please note that the In Situ Cushions are not part of any configuration or seating module and must be added separately to your order.</p> <p>*Please note that the In Situ Cushions are not part of any configuration or seating module and must be added separately to your order.</p>
Material	<p>Frame in powder-coated steel. Modules in an FSC™-certified (FSC-CO28824) wood construction with foam and wadding. Fully upholstered with textile, imitation leather, or leather. Leather from selected premium leather suppliers.</p> <p>The inside of the In Situ Cushion features a foam core with a pillowcase filled with fiber balls.</p>
Cleaning & Care	<p>For textile upholstered versions: In case of stains, we generally recommend removing non-greasy stains by carefully dabbing them with a lint-free cloth or sponge wrung out in clean, warm water. Clean by dabbing with soapy water made with a bit of dish soap if necessary. Finally, dab the surface with clean water. We advise visiting Kvadrat.dk, Nevotex.dk, Maharam.com, or Gabriel.dk for further cleaning and maintenance instructions for your chosen textile, as the cleaning methods may vary from one textile to another.</p> <p>Imitation Leather: Clean with lukewarm PH-neutral, soapy water and a soft cloth or soft brush. Do not use solvents or chemical cleaners, but cleaning can be done with alcohol-based cleaners. Finally, wipe with a damp cloth afterward.</p> <p>Leather: As a natural material, leather requires looking after. If you care for the leather correctly, it will become even more beautiful over time.</p> <p>Refine Leather, Easy Leather, and Endure Leather: Regularly clean leather with a dry cloth. Treat the leather at least four times a year using only special leather treatment products. Visit ca-mo.com for further information on cleaning leather.</p> <p>Allure and Grace Leather: Only vacuum clean with a soft brush. Never use soap or water; otherwise, the velvety look and feel will disappear. Do not apply leather grease or soak the leather. Avoid chemical products, such as saddle soap, leather cleaners, or household products.</p> <p>Base: Clean with a moist cloth. If necessary, use a little dish soap on the cloth.</p>

Module A80 + B80

Module C80

Module D80

Module E98

Module F98 + G98

Module H98 + I98

Cushion 70 x 50 cm / 27.6 x 19.7"

Cushion 70 x 30 cm / 27.6 x 11.8"

CUSTOMIZED UPHOLSTERY

Textile upholstery: 3,94 m / 4.31 yds — Leather upholstery: 9,43 m² / 101.50 ft²

Textile upholstery: 2,76 m / 3.02 yds — Leather upholstery: 6,33 m² / 68.14 ft²

Textile upholstery: 1,61 m / 1.76 yds — Leather upholstery: 4,57 m² / 49.19 ft²

Textile upholstery: 3,97 m / 4.34 yds — Leather upholstery: 9,66 m² / 103.98 ft²

Textile upholstery: 2,79 m / 3.05 yds — Leather upholstery: 7,48 m² / 80.51 ft²

Textile upholstery: 4,97 m / 5.44 yds — Leather upholstery: 12,56 m² / 135.20 ft²

Textile upholstery: 0,91 m / 1.0 yds — Leather upholstery: 2,53 m² / 27.23 ft²

Textile upholstery: 0,88 m / 0.96 yds — Leather upholstery: 1,47 m² / 15.82 ft²

TEST & CERTIFICATIONS

BIFMA X5.4 - 2020

American National Standard for Office Furnishings - Lounge and Public Seating

EN 16139:2013 - L2

Extreme use Furniture - Strength, durability and safety. Requirements for non-domestic seating.

EN 1022:2005

Domestic furniture - Seating - Determination of stability.

Forest Stewardship Council™

Module constructions are made using FSC™-certified (FSC-CO28824) wood.

VOC CDPH 01350 &
VOC BIFMA X7.1.

In Situ Modular Sofa in EU/US versions upholstered with Easy or Refine Leather or a large selection of Kvadrat textiles¹ are tested to VOC CDPH 01350 and VOC BIFMA X7.1.

¹Upholstered Muuto products that are tested to VOC CDPH 01350 and VOC BIFMA X7.1. are only compliant when upholstered with the following Kvadrat textiles: Balder, Canvas, Clara, Clay, Divina, Divina MD, Divina mélange, Fiord, Hallingdal, Hero, Ocean, Remix, Re-wool, Steelcut, Steelcut Trio, Vidar, Twill weave.

A grand modular sofa that can be tailored to your exact needs with its modular elements hidden through the subtle detailing of the frame's front profile, paired with deep comfort and a soft seat.

With the In Situ Modular Sofa, you can choose between any of the 30 predesigned configurations on the following pages or create your own configuration, following the guidelines below.

Visit planner.muuto.com to create your own configuration online.

Create your own In Situ Configuration

1. SEATING MODULES

Find the seating modules of your desired configuration and add the item numbers of the desired textile or leather upholstery separately to your order.

You can only connect modules to the open sides and end of the modules, illustrated here with dotted lines.

An In Situ configuration must always have one of the following seating modules at each end: Armrest Module (A8O, B8O, H98 or I98), Ottoman Module (D8O) or Open-Ended Module (F98 or G98).

The Ottoman Module (D8O) can only be used in extension of Open-Ended Modules (F98 or G98) or as the only free-standing I-Seater configuration possible to build.

SEATING MODULES

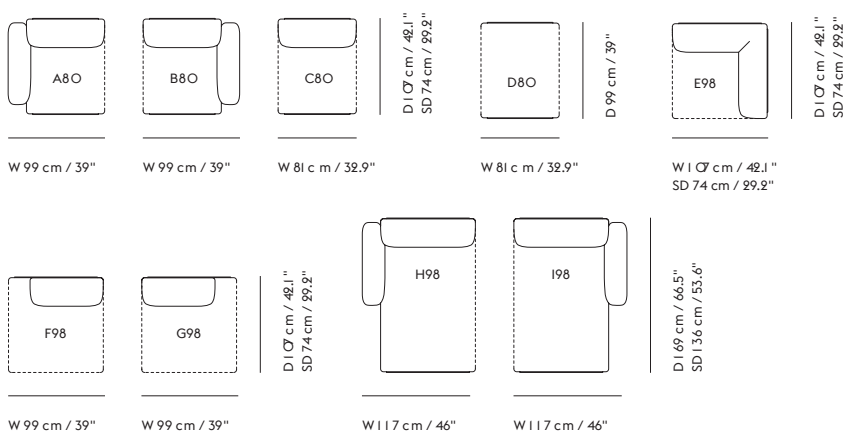

2. FRAME SECTIONS

Choose the frame section(s) that match the seating modules of the desired configuration (1 O frame sections to choose from in total). We recommend using as few frame sections as possible when creating your own configuration for a clean appearance.

A Frame Corner Section must always be supported by sections in the two open directions.

A configuration with chaise longue modules H98 or I98 must be created using at least 2 sections in total.

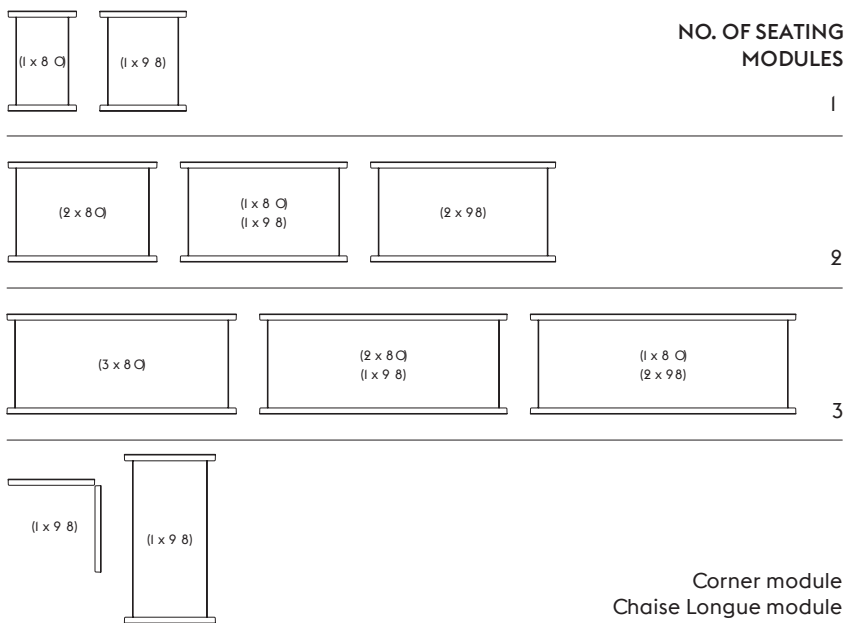

3. LINKING BRACKETS

Identify the amount of linking brackets required to connect the modules in your configuration, following the guidelines below. **Linking brackets must always be used when joining together frame sections.**

Linking brackets must always be mounted on the adjacent sections that face the corner section.

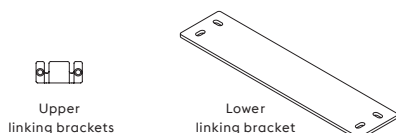

4. CUSHIONS

Specify optional cushions in the desired textile or leather for added comfort and a lounging expression.

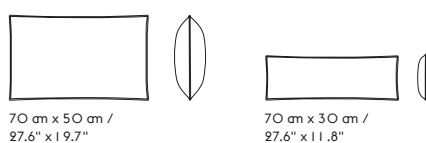

INSPIRATION FOR YOUR CONFIGURATION

2-seater Configurations

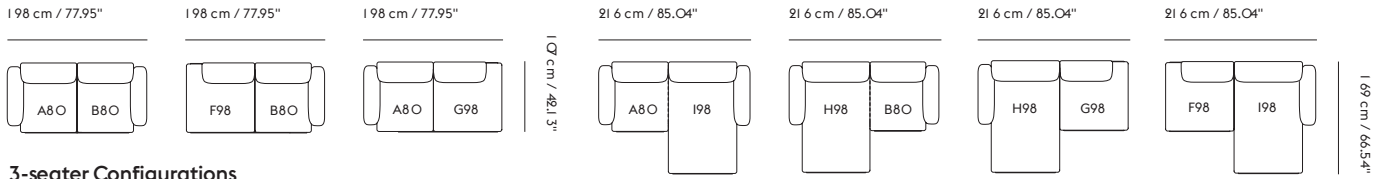

3-seater Configurations

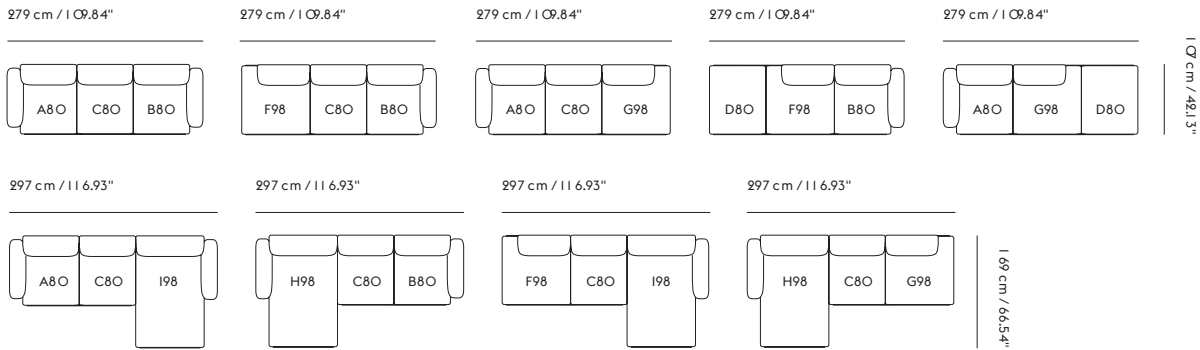

4-seater Configurations

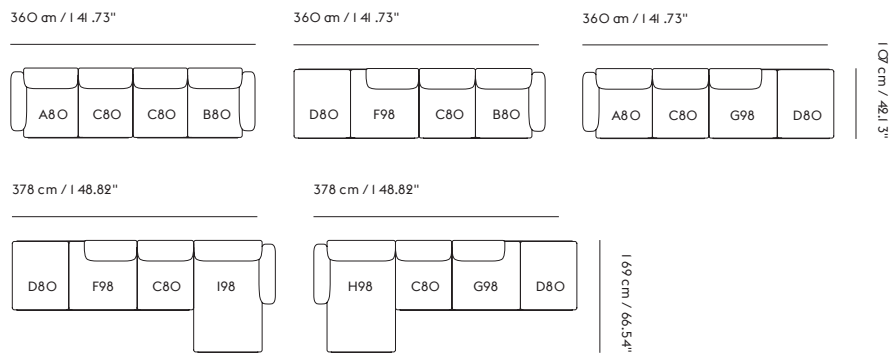

Corner Configurations

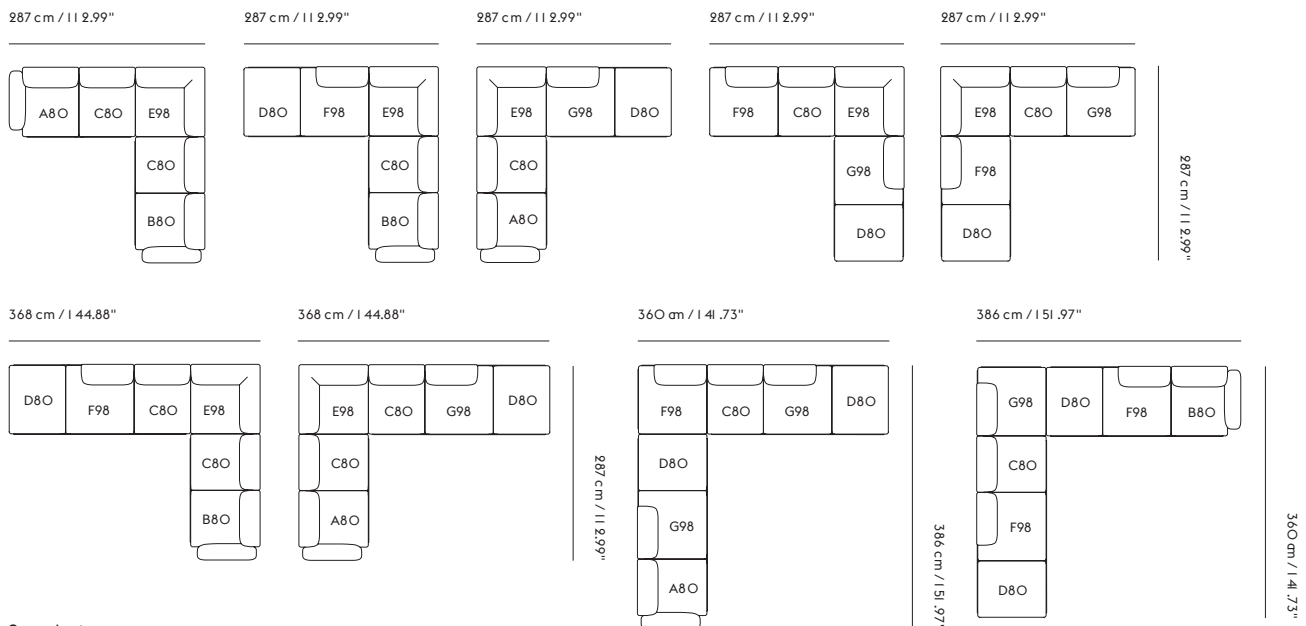

General note

The total dimensions of the configurations are indicative and can vary depending on how close the modules are placed as well as how many modules are combined.

IN SITU MODULAR SOFA / 2-SEATER - CONFIGURATION I



107 cm / 42.13"
SD 74 cm / 29.2"

198 cm / 77.95"

Shipper Colli	3
Gross Weight (kg)	107.3
Net Weight (kg)	80.74
Warranty Period	10 years

Pattern No.	Color	Contract Price	Lead Time
Ready-To-Ship US Warehouse			
MINS2C1-M16180	Frame and Module - Ocean 80/Black	USD 4,825.00	-
MINS2C1-M244912	Frame and Module - Clay 12/Black	USD 5,511.00	-
MINS2C1-M158554	Frame and Module - Vidar 554/Black	USD 5,511.00	-
Ready-To-Ship EU Warehouse			
MINS2C1-M10767240	Frame and Module - Ecriture 240/Black	USD 5,511.00	-
Extras			
99899	99899		-
99900	99900		-
MLEAKIT	Leather care set for Refine Leather	USD 27.00	-

IN SITU MODULAR SOFA / 2-SEATER - CONFIGURATION 2

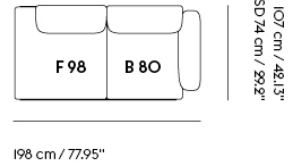

Shipper Colli 3
Gross Weight (kg) 96.2
Net Weight (kg) 76.59
Warranty Period 10 years

Pattern No.	Color	Contract Price	Lead Time
Ready-To-Ship US Warehouse			
MINS2C2-M16180	Frame and Module - Ocean 80/Black	USD 4,405.00	-
MINS2C2-M244912	Frame and Module - Clay 12/Black	USD 5,140.00	-
MINS2C2-M158554	Frame and Module - Vidar 554/Black	USD 5,140.00	-
Ready-To-Ship EU Warehouse			
MINS2C2-M10767240	Frame and Module - Ecriture 240/Black	USD 5,140.00	-
Extras			
99899	99899		-
99900	99900		-
MLEAKIT	Leather care set for Refine Leather	USD 27.00	-

IN SITU MODULAR SOFA / 2-SEATER - CONFIGURATION 3



198 cm / 77.95"

107 cm / 42.13"
SD 74 cm / 29.2"

Shipper Colli	3
Gross Weight (kg)	102.4
Net Weight (kg)	76.02
Warranty Period	10 years

Pattern No.	Color	Contract Price	Lead Time
Ready-To-Ship US Warehouse			
MINS2C3-M16180	Frame and Module - Ocean 80/Black	USD 4,405.00	-
MINS2C3-M244912	Frame and Module - Clay 12/Black	USD 5,140.00	-
MINS2C3-M158554	Frame and Module - Vidar 554/Black	USD 5,140.00	-
Ready-To-Ship EU Warehouse			
MINS2C3-M10767240	Frame and Module - Ecriture 240/Black	USD 5,140.00	-
Extras			
99899	99899		-
99900	99900		-
MLEAKIT	Leather care set for Refine Leather	USD 27.00	-

IN SITU MODULAR SOFA / 2-SEATER - CONFIGURATION 4

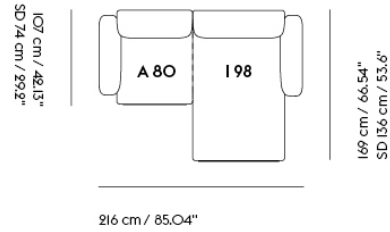

Shipper Colli	5
Gross Weight (kg)	133.8
Net Weight (kg)	103.21
Warranty Period	10 years

Pattern No.	Color	Contract Price	Lead Time
Ready-To-Ship US Warehouse			
MINS2C4-M16180	Frame and Module - Ocean 80/Black	USD 5,511.00	-
MINS2C4-M244912	Frame and Module - Clay 12/Black	USD 6,505.00	-
MINS2C4-M158554	Frame and Module - Vidar 554/Black	USD 6,505.00	-
Ready-To-Ship EU Warehouse			
MINS2C4-M10767240	Frame and Module - Ecriture 240/Black	USD 6,505.00	-
Extras			
99899	99899		-
99900	99900		-
MLEAKIT	Leather care set for Refine Leather	USD 27.00	-

IN SITU MODULAR SOFA / 2-SEATER - CONFIGURATION 5

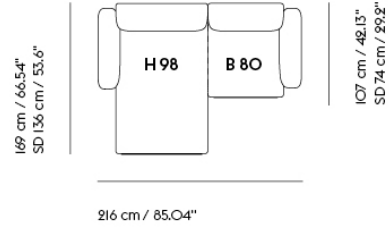

Shipper Colli 5
Gross Weight (kg) 133.8
Net Weight (kg) 103.21
Warranty Period 10 years

Pattern No.	Color	Contract Price	Lead Time
Ready-To-Ship US Warehouse			
MINS2C5-M16180	Frame and Module - Ocean 80/Black	USD 5,511.00	-
MINS2C5-M244912	Frame and Module - Clay 12/Black	USD 6,505.00	-
MINS2C5-M158554	Frame and Module - Vidar 554/Black	USD 6,505.00	-
Ready-To-Ship EU Warehouse			
MINS2C5-M10767240	Frame and Module - Ecriture 240/Black	USD 6,505.00	-
Extras			
99899	99899		-
99900	99900		-
MLEAKIT	Leather care set for Refine Leather	USD 27.00	-

IN SITU MODULAR SOFA / 2-SEATER - CONFIGURATION 6

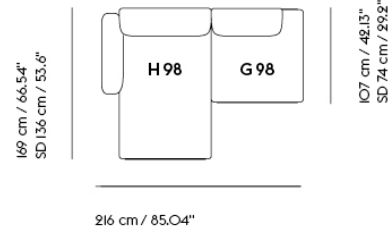

Shipper Colli	5
Gross Weight (kg)	128.9
Net Weight (kg)	98.49
Warranty Period	10 years

Pattern No.	Color	Contract Price	Lead Time
Ready-To-Ship US Warehouse			
MINS2C6-M16180	Frame and Module - Ocean 80/Black	USD 5,140.00	-
MINS2C6-M244912	Frame and Module - Clay 12/Black	USD 6,141.00	-
MINS2C6-M158554	Frame and Module - Vidar 554/Black	USD 6,141.00	-
Ready-To-Ship EU Warehouse			
MINS2C6-M10767240	Frame and Module - Ecriture 240/Black	USD 6,141.00	-
Extras			
99899	99899		-
99900	99900		-
MLEAKIT	Leather care set for Refine Leather	USD 27.00	-

IN SITU MODULAR SOFA / 2-SEATER - CONFIGURATION 7

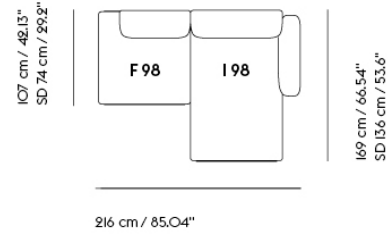

Shipper Colli	5
Gross Weight (kg)	122.7
Net Weight (kg)	99.06
Warranty Period	10 years

Pattern No.	Color	Contract Price	Lead Time
Ready-To-Ship US Warehouse			
MINS2C7-M16180	Frame and Module - Ocean 80/Black	USD 5,140.00	-
MINS2C7-M244912	Frame and Module - Clay 12/Black	USD 6,141.00	-
MINS2C7-M158554	Frame and Module - Vidar 554/Black	USD 6,141.00	-
Ready-To-Ship EU Warehouse			
MINS2C7-M10767240	Frame and Module - Ecriture 240/Black	USD 6,141.00	-
Extras			
99899	99899		-
99900	99900		-
MLEAKIT	Leather care set for Refine Leather	USD 27.00	-

IN SITU MODULAR SOFA / 3-SEATER - CONFIGURATION I

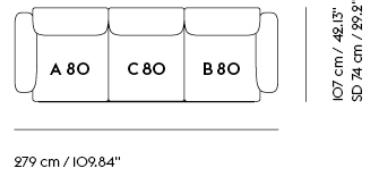

Shipper Colli	4
Gross Weight (kg)	145.5
Net Weight (kg)	110.95
Warranty Period	10 years

Pattern No.	Color	Contract Price	Lead Time
Ready-To-Ship US Warehouse			
MINS3C1-M16180	Frame and Module - Ocean 80/Black	USD 6,561.00	-
MINS3C1-M244912	Frame and Module - Clay 12/Black	USD 7,765.00	-
MINS3C1-M158554	Frame and Module - Vidar 554/Black	USD 7,765.00	-
Ready-To-Ship EU Warehouse			
MINS3C1-M10767240	Frame and Module - Ecriture 240/Black	USD 7,765.00	-
Extras			
99899	99899		-
99900	99900		-
MLEAKIT	Leather care set for Refine Leather	USD 27.00	-

IN SITU MODULAR SOFA / 3-SEATER - CONFIGURATION 2

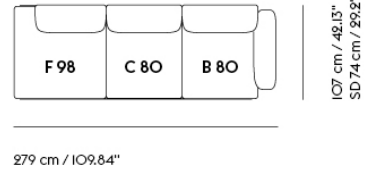

Shipper Colli	4
Gross Weight (kg)	134.3
Net Weight (kg)	106.7
Warranty Period	10 years

Pattern No.	Color	Contract Price	Lead Time
Ready-To-Ship US Warehouse			
MINS3C2-M16180	Frame and Module - Ocean 80/Black	USD 6,246.00	-
MINS3C2-M244912	Frame and Module - Clay 12/Black	USD 7,296.00	-
MINS3C2-M158554	Frame and Module - Vidar 554/Black	USD 7,296.00	-
Ready-To-Ship EU Warehouse			
MINS3C2-M10767240	Frame and Module - Ecriture 240/Black	USD 7,296.00	-
Extras			
99899	99899		-
99900	99900		-
MLEAKIT	Leather care set for Refine Leather	USD 27.00	-

IN SITU MODULAR SOFA / 3-SEATER - CONFIGURATION 3

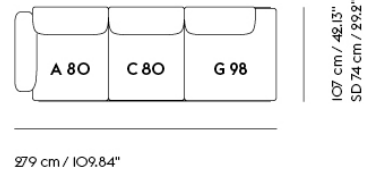

Shipper Colli 4
Gross Weight (kg) 140.5
Net Weight (kg) 106.13
Warranty Period 10 years

Pattern No.	Color	Contract Price	Lead Time
Ready-To-Ship US Warehouse			
MINS3C3-M16180	Frame and Module - Ocean 80/Black	USD 6,246.00	-
MINS3C3-M244912	Frame and Module - Clay 12/Black	USD 7,296.00	-
MINS3C3-M158554	Frame and Module - Vidar 554/Black	USD 7,296.00	-
Ready-To-Ship EU Warehouse			
MINS3C3-M10767240	Frame and Module - Ecriture 240/Black	USD 7,296.00	-
Extras			
99899	99899		-
99900	99900		-
MLEAKIT	Leather care set for Refine Leather	USD 27.00	-

IN SITU MODULAR SOFA / 3-SEATER - CONFIGURATION 4

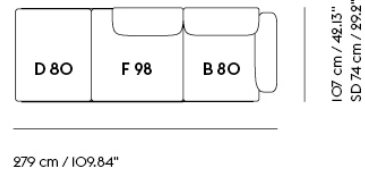

Shipper Colli	4
Gross Weight (kg)	122.2
Net Weight (kg)	95.07
Warranty Period	10 years

Pattern No.	Color	Contract Price	Lead Time
Ready-To-Ship US Warehouse			
MINS3C4-M16180	Frame and Module - Ocean 80/Black	USD 5,616.00	-
MINS3C4-M244912	Frame and Module - Clay 12/Black	USD 6,505.00	-
MINS3C4-M158554	Frame and Module - Vidar 554/Black	USD 6,505.00	-
Ready-To-Ship EU Warehouse			
MINS3C4-M10767240	Frame and Module - Ecriture 240/Black	USD 6,505.00	-
Extras			
99899	99899		-
99900	99900		-
MLEAKIT	Leather care set for Refine Leather	USD 27.00	-

IN SITU MODULAR SOFA / 3-SEATER - CONFIGURATION 5

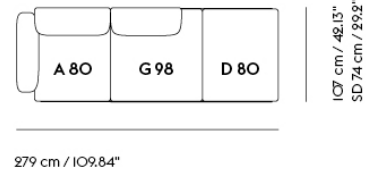

Shipper Colli	4
Gross Weight (kg)	128.4
Net Weight (kg)	94.5
Warranty Period	10 years

Pattern No.	Color	Contract Price	Lead Time
Ready-To-Ship US Warehouse			
MINS3C5-M16180	Frame and Module - Ocean 80/Black	USD 5,616.00	-
MINS3C5-M244912	Frame and Module - Clay 12/Black	USD 6,505.00	-
MINS3C5-M158554	Frame and Module - Vidar 554/Black	USD 6,505.00	-
Ready-To-Ship EU Warehouse			
MINS3C5-M10767240	Frame and Module - Ecriture 240/Black	USD 6,505.00	-
Extras			
99899	99899		-
99900	99900		-
MLEAKIT	Leather care set for Refine Leather	USD 27.00	-

IN SITU MODULAR SOFA / 3-SEATER - CONFIGURATION 6

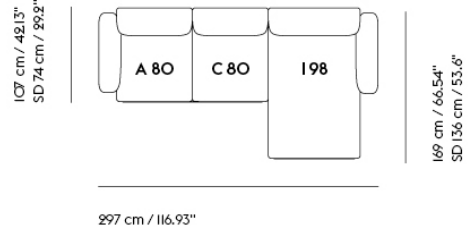

Shipper Colli	6
Gross Weight (kg)	171.9
Net Weight (kg)	133.22
Warranty Period	10 years

Pattern No.	Color	Contract Price	Lead Time
Ready-To-Ship US Warehouse			
MINS3C6-M16180	Frame and Module - Ocean 80/Black	USD 7,296.00	-
MINS3C6-M244912	Frame and Module - Clay 12/Black	USD 8,661.00	-
MINS3C6-M158554	Frame and Module - Vidar 554/Black	USD 8,661.00	-
Ready-To-Ship EU Warehouse			
MINS3C6-M10767240	Frame and Module - Ecriture 240/Black	USD 8,661.00	-
Extras			
99899	99899		-
99900	99900		-
MLEAKIT	Leather care set for Refine Leather	USD 27.00	-

IN SITU MODULAR SOFA / 3-SEATER - CONFIGURATION 7

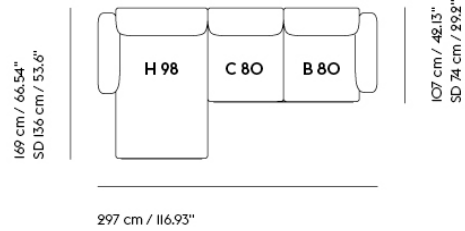

Shipper Colli	6
Gross Weight (kg)	171.9
Net Weight (kg)	133.22
Warranty Period	10 years

Pattern No.	Color	Contract Price	Lead Time
Ready-To-Ship US Warehouse			
MINS3C7-M16180	Frame and Module - Ocean 80/Black	USD 7,296.00	-
MINS3C7-M244912	Frame and Module - Clay 12/Black	USD 8,661.00	-
MINS3C7-M158554	Frame and Module - Vidar 554/Black	USD 8,661.00	-
Ready-To-Ship EU Warehouse			
MINS3C7-M10767240	Frame and Module - Ecriture 240/Black	USD 8,661.00	-
Extras			
99899	99899		-
99900	99900		-
MLEAKIT	Leather care set for Refine Leather	USD 27.00	-

IN SITU MODULAR SOFA / 3-SEATER - CONFIGURATION 8

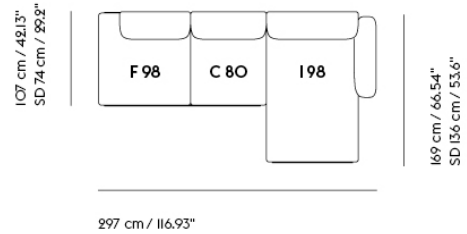

Shipper Colli	6
Gross Weight (kg)	160.8
Net Weight (kg)	129.07
Warranty Period	10 years

Pattern No.	Color	Contract Price	Lead Time
Ready-To-Ship US Warehouse			
MINS3C8-M16180	Frame and Module - Ocean 80/Black	USD 6,876.00	-
MINS3C8-M244912	Frame and Module - Clay 12/Black	USD 8,290.00	-
MINS3C8-M158554	Frame and Module - Vidar 554/Black	USD 8,290.00	-
Ready-To-Ship EU Warehouse			
MINS3C8-M10767240	Frame and Module - Ecriture 240/Black	USD 8,290.00	-
Extras			
99899	99899		-
99900	99900		-
MLEAKIT	Leather care set for Refine Leather	USD 27.00	-

IN SITU MODULAR SOFA / 3-SEATER - CONFIGURATION 9

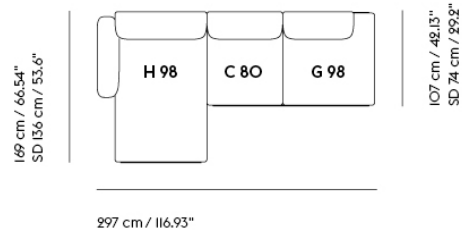

Shipper Colli	6
Gross Weight (kg)	167
Net Weight (kg)	128.5
Warranty Period	10 years

Pattern No.	Color	Contract Price	Lead Time
Ready-To-Ship US Warehouse			
MINS3C9-M16180	Frame and Module - Ocean 80/Black	USD 6,876.00	-
MINS3C9-M244912	Frame and Module - Clay 12/Black	USD 8,290.00	-
MINS3C9-M158554	Frame and Module - Vidar 554/Black	USD 8,290.00	-
Ready-To-Ship EU Warehouse			
MINS3C9-M10767240	Frame and Module - Ecriture 240/Black	USD 8,290.00	-
Extras			
99899	99899		-
99900	99900		-
MLEAKIT	Leather care set for Refine Leather	USD 27.00	-

IN SITU MODULAR SOFA / 4-SEATER - CONFIGURATION I

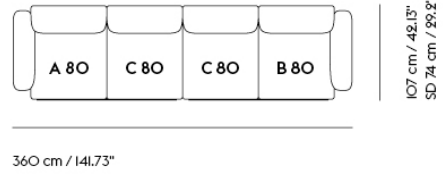

Shipper Colli	7
Gross Weight (kg)	191.2
Net Weight (kg)	147.5
Warranty Period	10 years

Pattern No.	Color	Contract Price	Lead Time
Ready-To-Ship US Warehouse			
MINS4C1-M16180	Frame and Module - Ocean 80/Black	USD 8,346.00	-
MINS4C1-M244912	Frame and Module - Clay 12/Black	USD 9,921.00	-
MINS4C1-M158554	Frame and Module - Vidar 554/Black	USD 9,921.00	-
Ready-To-Ship EU Warehouse			
MINS4C1-M10767240	Frame and Module - Ecriture 240/Black	USD 9,921.00	-
Extras			
99899	99899		-
99900	99900		-
MLEAKIT	Leather care set for Refine Leather	USD 27.00	-

IN SITU MODULAR SOFA / 4-SEATER - CONFIGURATION 2

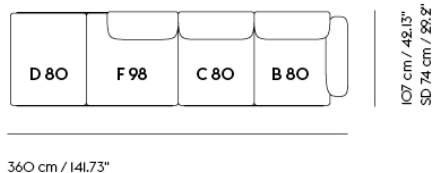

Shipper Colli	7
Gross Weight (kg)	168
Net Weight (kg)	131.72
Warranty Period	10 years

Pattern No.	Color	Contract Price	Lead Time
Ready-To-Ship US Warehouse			
MINS4C2-M16180	Frame and Module - Ocean 80/Black	USD 7,450.00	-
MINS4C2-M244912	Frame and Module - Clay 12/Black	USD 8,766.00	-
MINS4C2-M158554	Frame and Module - Vidar 554/Black	USD 8,766.00	-
Ready-To-Ship EU Warehouse			
MINS4C2-M10767240	Frame and Module - Ecriture 240/Black	USD 8,766.00	-
Extras			
99899	99899		-
99900	99900		-
MLEAKIT	Leather care set for Refine Leather	USD 27.00	-

IN SITU MODULAR SOFA / 4-SEATER - CONFIGURATION 3

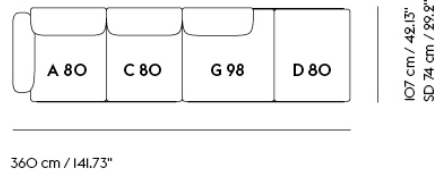

Shipper Colli	7
Gross Weight (kg)	174.2
Net Weight (kg)	131.15
Warranty Period	10 years

Pattern No.	Color	Contract Price	Lead Time
Ready-To-Ship US Warehouse			
MINS4C3-M16180	Frame and Module - Ocean 80/Black	USD 7,450.00	-
MINS4C3-M244912	Frame and Module - Clay 12/Black	USD 8,766.00	-
MINS4C3-M158554	Frame and Module - Vidar 554/Black	USD 8,766.00	-
Ready-To-Ship EU Warehouse			
MINS4C3-M10767240	Frame and Module - Ecriture 240/Black	USD 8,766.00	-
Extras			
99899	99899		-
99900	99900		-
MLEAKIT	Leather care set for Refine Leather	USD 27.00	-

IN SITU MODULAR SOFA / 4-SEATER - CONFIGURATION 4

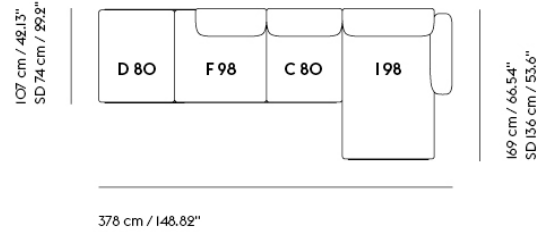

Shipper Colli	7
Gross Weight (kg)	186.8
Net Weight (kg)	147.55
Warranty Period	10 years

Pattern No.	Color	Contract Price	Lead Time
Ready-To-Ship US Warehouse			
MINS4C4-M16180	Frame and Module - Ocean 80/Black	USD 8,031.00	-
MINS4C4-M244912	Frame and Module - Clay 12/Black	USD 9,606.00	-
MINS4C4-M158554	Frame and Module - Vidar 554/Black	USD 9,606.00	-
Ready-To-Ship EU Warehouse			
MINS4C4-M10767240	Frame and Module - Ecriture 240/Black	USD 9,606.00	-
Extras			
99899	99899		-
99900	99900		-
MLEAKIT	Leather care set for Refine Leather	USD 27.00	-

IN SITU MODULAR SOFA / 4-SEATER - CONFIGURATION 5

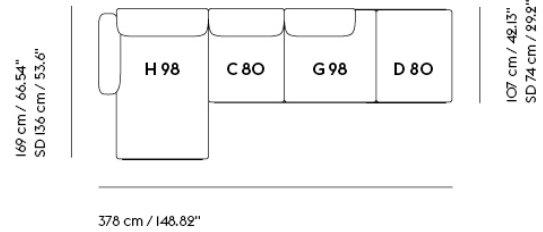

Shipper Colli 7
Gross Weight (kg) 193
Net Weight (kg) 146.98
Warranty Period 10 years

Pattern No.	Color	Contract Price	Lead Time
Ready-To-Ship US Warehouse			
MINS4C5-M16180	Frame and Module - Ocean 80/Black	USD 8,031.00	-
MINS4C5-M244912	Frame and Module - Clay 12/Black	USD 9,606.00	-
MINS4C5-M158554	Frame and Module - Vidar 554/Black	USD 9,606.00	-
Ready-To-Ship EU Warehouse			
MINS4C5-M10767240	Frame and Module - Ecriture 240/Black	USD 9,606.00	-
Extras			
99899	99899		-
99900	99900		-
MLEAKIT	Leather care set for Refine Leather	USD 27.00	-

IN SITU MODULAR SOFA / CORNER - CONFIGURATION I

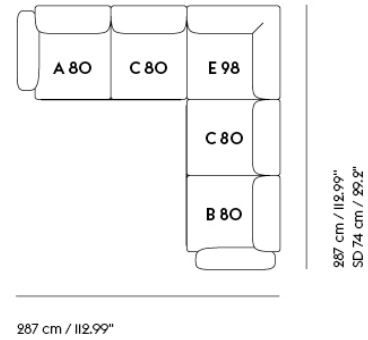

Shipper Colli	10
Gross Weight (kg)	249.4
Net Weight (kg)	192.2
Warranty Period	10 years

Pattern No.	Color	Contract Price	Lead Time
Ready-To-Ship US Warehouse			
MINSPSCC1-M16180	Frame and Module - Ocean 80/Black	USD 11,545.00	-
MINSPSCC1-M244912	Frame and Module - Clay 12/Black	USD 13,120.00	-
MINSPSCC1-M158554	Frame and Module - Vidar 554/Black	USD 13,120.00	-
Ready-To-Ship EU Warehouse			
MINSPSCC1-M10767240	Frame and Module - Ecriture 240/Black	USD 13,120.00	-
Extras			
99899	99899		-
99900	99900		-
MLEAKIT	Leather care set for Refine Leather	USD 27.00	-

IN SITU MODULAR SOFA / CORNER - CONFIGURATION 2

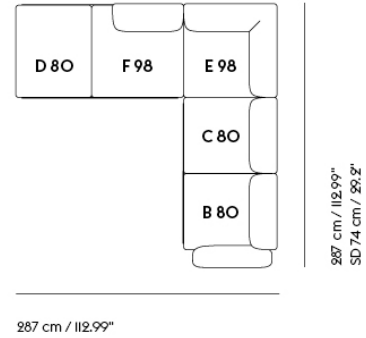

Shipper Colli	10
Gross Weight (kg)	226.2
Net Weight (kg)	176.42
Warranty Period	10 years

Pattern No.	Color	Contract Price	Lead Time
Ready-To-Ship US Warehouse			
MINSPPCC2-M16180	Frame and Module - Ocean 80/Black	USD 10,131.00	-
MINSPPCC2-M244912	Frame and Module - Clay 12/Black	USD 12,070.00	-
MINSPPCC2-M158554	Frame and Module - Vidar 554/Black	USD 12,070.00	-
Ready-To-Ship EU Warehouse			
MINSPPCC2-M10767240	Frame and Module - Ecriture 240/Black	USD 12,070.00	-
Extras			
99899	99899		-
99900	99900		-
MLEAKIT	Leather care set for Refine Leather	USD 27.00	-

IN SITU MODULAR SOFA / CORNER - CONFIGURATION 3

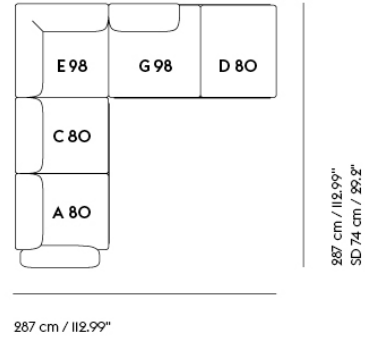

Shipper Colli	10
Gross Weight (kg)	232.4
Net Weight (kg)	175.85
Warranty Period	10 years

Pattern No.	Color	Contract Price	Lead Time
Ready-To-Ship US Warehouse			
MINSPSCC3-M16180	Frame and Module - Ocean 80/Black	USD 10,131.00	-
MINSPSCC3-M244912	Frame and Module - Clay 12/Black	USD 12,070.00	-
MINSPSCC3-M158554	Frame and Module - Vidar 554/Black	USD 12,070.00	-
Ready-To-Ship EU Warehouse			
MINSPSCC3-M10767240	Frame and Module - Ecriture 240/Black	USD 12,070.00	-
Extras			
99899	99899		-
99900	99900		-
MLEAKIT	Leather care set for Refine Leather	USD 27.00	-

IN SITU MODULAR SOFA / CORNER - CONFIGURATION 4

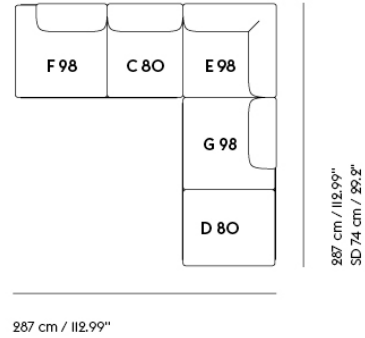

Shipper Colli	10
Gross Weight (kg)	221.3
Net Weight (kg)	171.7
Warranty Period	10 years

Pattern No.	Color	Contract Price	Lead Time
Ready-To-Ship US Warehouse			
MINSPSCC4-M16180	Frame and Module - Ocean 80/Black	USD 9,711.00	-
MINSPSCC4-M244912	Frame and Module - Clay 12/Black	USD 11,545.00	-
MINSPSCC4-M158554	Frame and Module - Vidar 554/Black	USD 11,545.00	-
Ready-To-Ship EU Warehouse			
MINSPSCC4-M10767240	Frame and Module - Ecriture 240/Black	USD 11,545.00	-
Extras			
99899	99899		-
99900	99900		-
MLEAKIT	Leather care set for Refine Leather	USD 27.00	-

IN SITU MODULAR SOFA / CORNER - CONFIGURATION 5

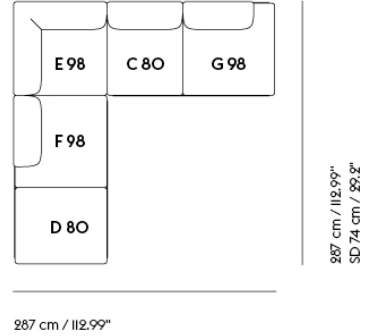

Shipper Colli	10
Gross Weight (kg)	221.3
Net Weight (kg)	171.7
Warranty Period	10 years

Pattern No.	Color	Contract Price	Lead Time
Ready-To-Ship US Warehouse			
MINSPSCC5-M16180	Frame and Module - Ocean 80/Black	USD 9,711.00	-
MINSPSCC5-M244912	Frame and Module - Clay 12/Black	USD 11,545.00	-
MINSPSCC5-M158554	Frame and Module - Vidar 554/Black	USD 11,545.00	-
Ready-To-Ship EU Warehouse			
MINSPSCC5-M10767240	Frame and Module - Ecriture 240/Black	USD 11,545.00	-
Extras			
99899	99899		-
99900	99900		-
MLEAKIT	Leather care set for Refine Leather	USD 27.00	-

IN SITU MODULAR SOFA / CORNER - CONFIGURATION 6

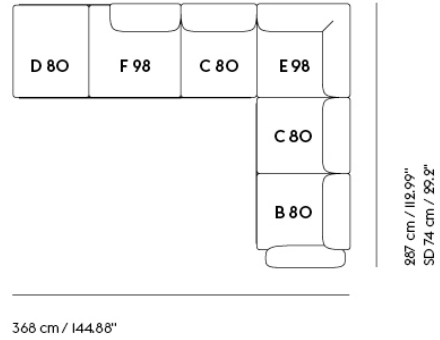

Shipper Colli II
Gross Weight (kg) 264.3
Net Weight (kg) 206.53
Warranty Period 10 years

Pattern No.	Color	Contract Price	Lead Time
Ready-To-Ship US Warehouse			
MINSPSCC6-M16180	Frame and Module - Ocean 80/Black	USD 12,070.00	-
MINSPSCC6-M244912	Frame and Module - Clay 12/Black	USD 14,170.00	-
MINSPSCC6-M158554	Frame and Module - Vidar 554/Black	USD 14,170.00	-
Ready-To-Ship EU Warehouse			
MINSPSCC6-M10767240	Frame and Module - Ecriture 240/Black	USD 14,170.00	-
Extras			
99899	99899		-
99900	99900		-
MLEAKIT	Leather care set for Refine Leather	USD 27.00	-

IN SITU MODULAR SOFA / CORNER - CONFIGURATION 7

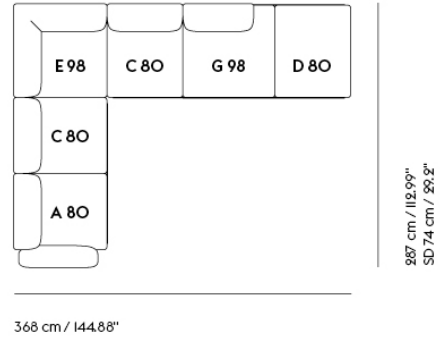

Shipper Colli	11
Gross Weight (kg)	270.5
Net Weight (kg)	205.96
Warranty Period	10 years

Pattern No.	Color	Contract Price	Lead Time
Ready-To-Ship US Warehouse			
MINSPSCC7-M16180	Frame and Module - Ocean 80/Black	USD 12,070.00	-
MINSPSCC7-M244912	Frame and Module - Clay 12/Black	USD 14,170.00	-
MINSPSCC7-M158554	Frame and Module - Vidar 554/Black	USD 14,170.00	-
Ready-To-Ship EU Warehouse			
MINSPSCC7-M10767240	Frame and Module - Ecriture 240/Black	USD 14,170.00	-
Extras			
99899	99899		-
99900	99900		-
MLEAKIT	Leather care set for Refine Leather	USD 27.00	-

IN SITU MODULAR SOFA / CORNER - CONFIGURATION 8

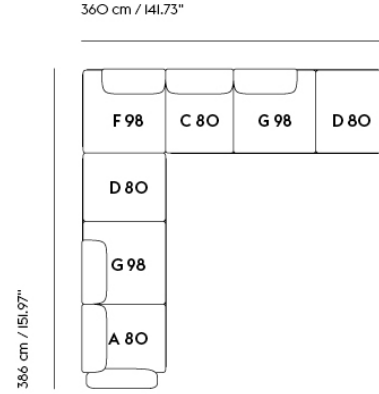

Shipper Colli	12
Gross Weight (kg)	288.5
Net Weight (kg)	218.46
Warranty Period	10 years

Pattern No.	Color	Contract Price	Lead Time
Ready-To-Ship US Warehouse			
MINSPSCC8-M16180	Frame and Module - Ocean 80/Black	USD 12,595.00	-
MINSPSCC8-M244912	Frame and Module - Clay 12/Black	USD 15,745.00	-
MINSPSCC8-M158554	Frame and Module - Vidar 554/Black	USD 15,745.00	-
Ready-To-Ship EU Warehouse			
MINSPSCC8-M10767240	Frame and Module - Ecriture 240/Black	USD 15,745.00	-
Extras			
99899	99899		-
99900	99900		-
MLEAKIT	Leather care set for Refine Leather	USD 27.00	-

IN SITU MODULAR SOFA / CORNER - CONFIGURATION 9

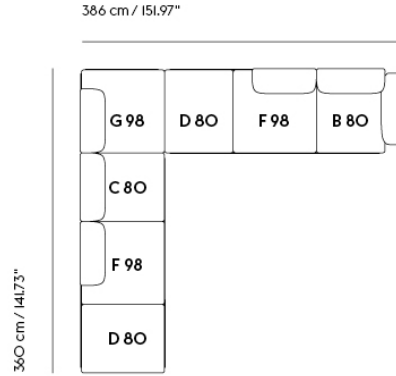

Shipper Colli	12
Gross Weight (kg)	282.3
Net Weight (kg)	219.03
Warranty Period	10 years

Pattern No.	Color	Contract Price	Lead Time
Ready-To-Ship US Warehouse			
MINSPSCC9-M16180	Frame and Module - Ocean 80/Black	USD 12,595.00	-
MINSPSCC9-M244912	Frame and Module - Clay 12/Black	USD 15,745.00	-
MINSPSCC9-M158554	Frame and Module - Vidar 554/Black	USD 15,745.00	-
Ready-To-Ship EU Warehouse			
MINSPSCC9-M10767240	Frame and Module - Ecriture 240/Black	USD 15,745.00	-
Extras			
99899	99899		-
99900	99900		-
MLEAKIT	Leather care set for Refine Leather	USD 27.00	-

IN SITU MODULAR SOFA / LEFT ARMREST MODULE (A80)

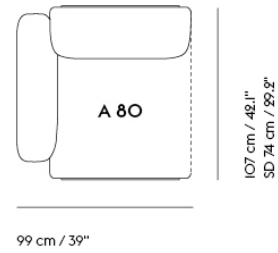

- Shipper Colli** | 1
- Gross Weight (kg)** | 42.7
- Net Weight (kg)** | 31.25
- Please note** | This product features an armrest on the left-hand side when facing the product from the front.
- Please note** | This variant is a Seating Module only and does not include a Frame Section.
- Warranty Period** | 10 years

Pattern No.	Color	Contract Price	Lead Time
Ready-To-Ship US Warehouse			
MINSAML-M16180	Ocean 80	USD 2,256.00	-
MINSAML-M244912	Clay 12	USD 2,571.00	-
MINSAML-M158554	Vidar 554	USD 2,571.00	-
Ready-To-Ship EU Warehouse			
MINSAML-M10767240	Ecriture 240	USD 2,571.00	-
Extras			
MLEAKIT	Leather care set for Refine Leather	USD 27.00	-

IN SITU MODULAR SOFA / RIGHT ARMREST MODULE (B80)

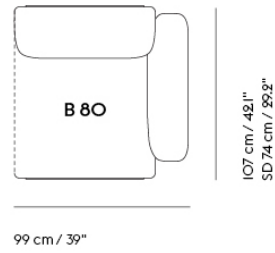

- Shipper Colli** | 1
- Gross Weight (kg)** | 42.7
- Net Weight (kg)** | 31.25
- Please note** | This product features an armrest on the right-hand side when facing the product from the front.
- Please note** | This variant is a Seating Module only and does not include a Frame Section.
- Warranty Period** | 10 years

Pattern No.	Color	Contract Price	Lead Time
Ready-To-Ship US Warehouse			
MINSAMR-M16180	Ocean 80	USD 2,256.00	-
MINSAMR-M244912	Clay 12	USD 2,571.00	-
MINSAMR-M158554	Vidar 554	USD 2,571.00	-
Ready-To-Ship EU Warehouse			
MINSAMR-M10767240	Ecriture 240	USD 2,571.00	-
Extras			
MLEAKIT	Leather care set for Refine Leather	USD 27.00	-

IN SITU MODULAR SOFA / CENTRE MODULE (C80)

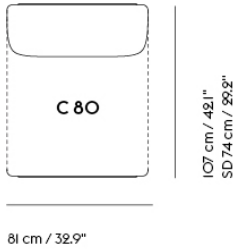

- Shipper Colli 1
- Gross Weight (kg) 30.2
- Net Weight (kg) 23.53
- Please note This variant is a Seating Module only and does not include a Frame Section.
- Warranty Period 10 years

Pattern No.	Color	Contract Price	Lead Time
Ready-To-Ship US Warehouse			
MINSCTM-M16180	Ocean 80	USD 1,570.00	-
MINSCTM-M244912	Clay 12	USD 2,046.00	-
MINSCTM-M158554	Vidar 554 ***	USD 2,046.00	-
Ready-To-Ship EU Warehouse			
MINSCTM-M10767240	Ecriture 240	USD 2,046.00	-
Extras			
MLEAKIT	Leather care set for Refine Leather	USD 27.00	-

VARIANTS MARKED WITH *** WILL BE MADE-TO-ORDER OR DISCONTINUED WHEN OUT OF STOCK
FOR MORE INFORMATION VISIT MUUTO.COM

IN SITU MODULAR SOFA / OTTOMAN
MODULE (D80)

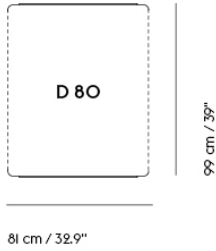

- Shipper Colli 1
- Gross Weight (kg) 18.1
- Net Weight (kg) 11.9
- Please note This variant is a Seating Module only and does not include a Frame Section.
- Warranty Period 10 years

Pattern No.	Color	Contract Price	Lead Time
Ready-To-Ship US Warehouse			
MINSOTM-M16180	Ocean 80	USD 881.00	-
MINSOTM-M244912	Clay 12	USD 1,101.00	-
MINSOTM-M158554	Vidar 554	USD 1,101.00	-
Ready-To-Ship EU Warehouse			
MINSOTM-M10767240	Ecriture 240	USD 1,101.00	-
Extras			
MLEAKIT	Leather care set for Refine Leather	USD 27.00	-

**IN SITU MODULAR SOFA / CORNER
MODULE (E98)**

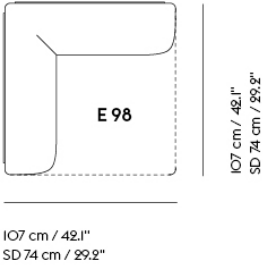

- Shipper Colli** | 1
- Gross Weight (kg)** | 45.8
- Net Weight (kg)** | 34.68
- Please note** | This variant is a Seating Module only and does not include a Frame Section.
- Warranty Period** | 10 years

Pattern No.	Color	Contract Price	Lead Time
Ready-To-Ship US Warehouse			
MINSCOM-M16180	Ocean 80	USD 2,515.00	-
MINSCOM-M244912	Clay 12	USD 2,886.00	-
MINSCOM-M158554	Vidar 554	USD 2,886.00	-
Ready-To-Ship EU Warehouse			
MINSCOM-M10767240	Ecriture 240	USD 2,886.00	-
Extras			
MLEAKIT	Leather care set for Refine Leather	USD 27.00	-

IN SITU MODULAR SOFA / LEFT OPEN-ENDED MODULE (F98)

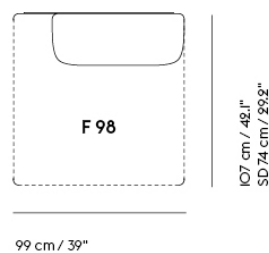
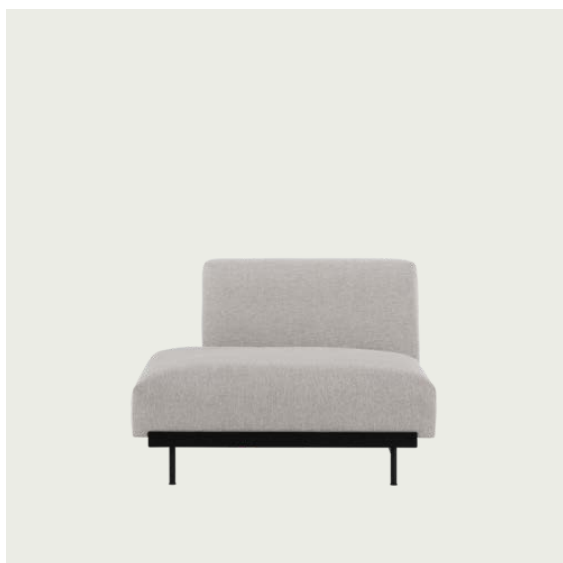

Shipper Colli	1
Gross Weight (kg)	30.2
Net Weight (kg)	25.7
Please note	This product features an open end on the left-hand side when facing the product from the front.
Please note	This variant is a Seating Module only and does not include a Frame Section.
Warranty Period	10 years

Pattern No.	Color	Contract Price	Lead Time
Ready-To-Ship US Warehouse			
MINSOEML-M16180	Ocean 80	USD 1,731.00	-
MINSOEML-M244912	Clay 12	USD 2,256.00	-
MINSOEML-M158554	Vidar 554	USD 2,256.00	-
Ready-To-Ship EU Warehouse			
MINSOEML-M10767240	Ecriture 240	USD 2,256.00	-
Extras			
MLEAKIT	Leather care set for Refine Leather	USD 27.00	-

IN SITU MODULAR SOFA / RIGHT OPEN-ENDED MODULE (G98)

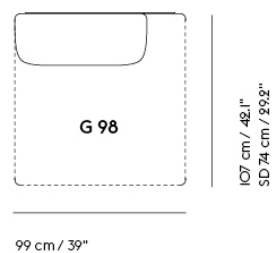
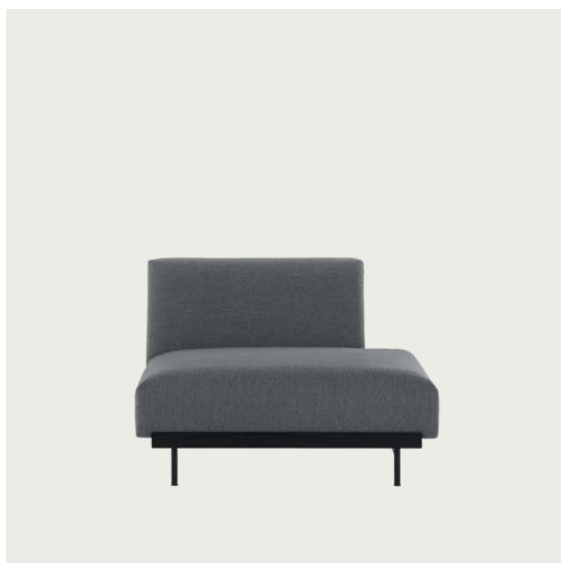

Shipper Colli	1
Gross Weight (kg)	36.4
Net Weight (kg)	25.13
Please note	This product features an open end on the right-hand side when facing the product from the front.
Please note	This variant is a Seating Module only and does not include a Frame Section.
Warranty Period	10 years

Pattern No.	Color	Contract Price	Lead Time
Ready-To-Ship US Warehouse			
MINSOEMR-M16180	Ocean 80	USD 1,731.00	-
MINSOEMR-M244912	Clay 12	USD 2,256.00	-
MINSOEMR-M158554	Vidar 554	USD 2,256.00	-
Ready-To-Ship EU Warehouse			
MINSOEMR-M10767240	Ecriture 240	USD 2,256.00	-
Extras			
MLEAKIT	Leather care set for Refine Leather	USD 27.00	-

IN SITU MODULAR SOFA / LEFT ARMREST LOUNGE MODULE (H98)

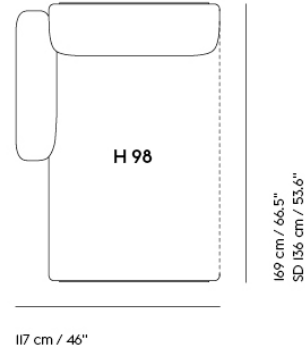

- Shipper Colli** | 1
- Gross Weight (kg)** 55.8
- Net Weight (kg)** 42.7
- Please note** This product features an armrest on the left-hand side when facing the product from the front.
- Please note** This variant is a Seating Module only and does not include a Frame Section.
- Warranty Period** 10 years

Pattern No.	Color	Contract Price	Lead Time
Ready-To-Ship US Warehouse			
MINSALML-M16180	Ocean 80	USD 2,830.00	-
MINSALML-M244912	Clay 12	USD 3,516.00	-
MINSALML-M158554	Vidar 554	USD 3,516.00	-
Ready-To-Ship EU Warehouse			
MINSALML-M10767240	Ecriture 240	USD 3,516.00	-
Extras			
MLEAKIT	Leather care set for Refine Leather	USD 27.00	-

IN SITU MODULAR SOFA / RIGHT ARMREST LOUNGE MODULE (I98)

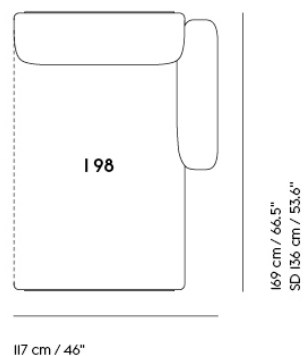

Shipper Colli	1
Gross Weight (kg)	55.8
Net Weight (kg)	42.7
Please note	This product features an armrest on the right-hand side when facing the product from the front.
Please note	This variant is a Seating Module only and does not include a Frame Section.
Warranty Period	10 years

Pattern No.	Color	Contract Price	Lead Time
Ready-To-Ship US Warehouse			
MINSALMR-M16180	Ocean 80	USD 2,830.00	-
MINSALMR-M244912	Clay 12	USD 3,516.00	-
MINSALMR-M158554	Vidar 554	USD 3,516.00	-
Ready-To-Ship EU Warehouse			
MINSALMR-M10767240	Ecriture 240	USD 3,516.00	-
Extras			
MLEAKIT	Leather care set for Refine Leather	USD 27.00	-

**IN SITU MODULAR SOFA / CUSHION —
70 X 30 CM / 27.6 X 11.8"**

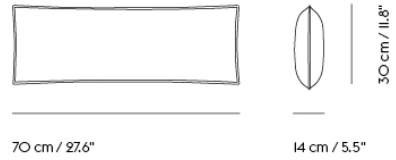

Shipper Colli 1
 Gross Weight (kg) 0.8
 Net Weight (kg) 0.8
 Warranty Period 10 years

Pattern No.	Color	Contract Price	Lead Time
Ready-To-Ship US Warehouse			
MINSCUS2610-M16180	Ocean 80	USD 167.00	-
MINSCUS2610-M244912	Clay 12	USD 257.00	-
MINSCUS2610-M158554	Vidar 554	USD 257.00	-
Extras			
MLEAKIT	Leather care set for Refine Leather	USD 27.00	-

**IN SITU MODULAR SOFA / CUSHION —
70 X 50 CM / 27.6 X 19.7"**

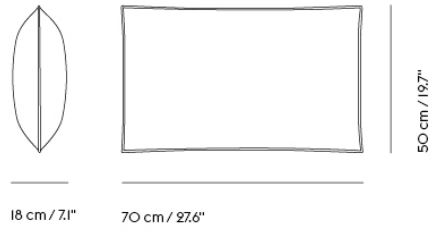

Shipper Colli 1
 Gross Weight (kg) 1.75
 Net Weight (kg) 1.75
 Warranty Period 10 years

Pattern No.	Color	Contract Price	Lead Time
Ready-To-Ship US Warehouse			
MINSCUS2618-M16180	Ocean 80	USD 226.00	-
MINSCUS2618-M244912	Clay 12	USD 310.00	-
MINSCUS2618-M158554	Vidar 554	USD 310.00	-
Extras			
MLEAKIT	Leather care set for Refine Leather	USD 27.00	-

IN SITU MODULAR SOFA / FRAME SECTION (1 X 80)

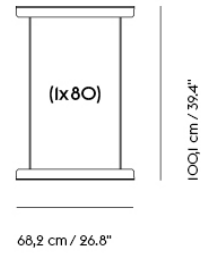

Shipper Colli 1
 Gross Weight (kg) 14
 Net Weight (kg) 11.76
 Warranty Period 10 years

Pattern No.	Color	Contract Price	Lead Time
Ready-To-Ship US Warehouse			
MINSFRMS80	Black - 1 x 80	USD 289.00	-
Extras			
99899	99899		-
99900	99900		-

IN SITU MODULAR SOFA / FRAME SECTION (1 X 98)

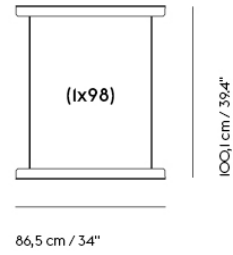

Shipper Colli 1
Gross Weight (kg) 15.4
Net Weight (kg) 13.16
Warranty Period 10 years

Pattern No.	Color	Contract Price	Lead Time
Ready-To-Ship US Warehouse			
MINSFRMS98	Black - 1 x 98	USD 289.00	-
Extras			
99899	99899		-
99900	99900		-

IN SITU MODULAR SOFA / FRAME SECTION (2 X 80)

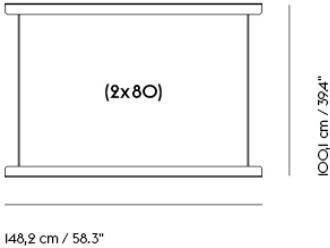

Shipper Colli 1
Gross Weight (kg) 21.9
Net Weight (kg) 18.24
Warranty Period 10 years

Pattern No.	Color	Contract Price	Lead Time
Ready-To-Ship US Warehouse			
MINSFRMS8080	Black - 2 x 80	USD 576.00	-
Extras			
99899	99899		-
99900	99900		-

IN SITU MODULAR SOFA / FRAME SECTION (2 X 98)

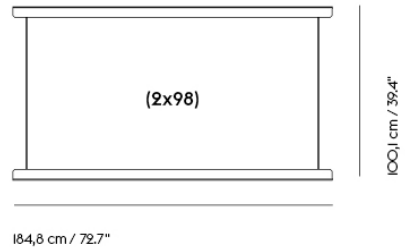

Shipper Colli 1
Gross Weight (kg) 24.8
Net Weight (kg) 21.14
Warranty Period 10 years

Pattern No.	Color	Contract Price	Lead Time
Ready-To-Ship US Warehouse			
MINSFRMS9898	Black - 2 x 98	USD 576.00	-
Extras			
99899	99899		-
99900	99900		-

IN SITU MODULAR SOFA / FRAME SECTION (3 X 80)

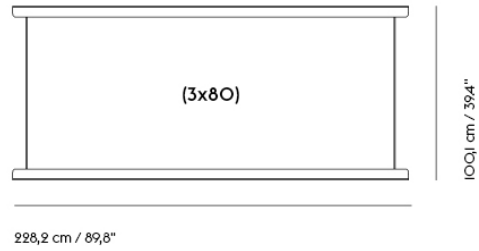

Shipper Colli | 1
Gross Weight (kg) | 29.9
Net Weight (kg) | 24.92
Warranty Period | 10 years

Pattern No.	Color	Contract Price	Lead Time
Ready-To-Ship US Warehouse			
MINSFRMS808080	Black - 3 x 80	USD 866.00	-
Extras			
99899	99899		-
99900	99900		-

**IN SITU MODULAR SOFA / FRAME
SECTION (1 X 80 + 1 X 98)**

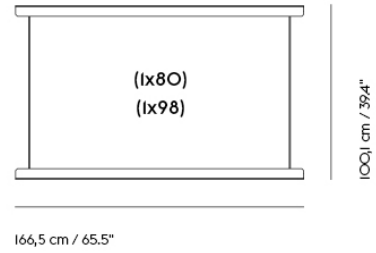

Shipper Colli 1
 Gross Weight (kg) 23.3
 Net Weight (kg) 19.64
 Warranty Period 10 years

Pattern No.	Color	Contract Price	Lead Time
Ready-To-Ship US Warehouse			
MINSFRMS8098	Black - 1 x 80 + 1 x 98	USD 576.00	-
Extras			
99899	99899		-
99900	99900		-

IN SITU MODULAR SOFA / FRAME SECTION (1 X 80 + 2 X 98)

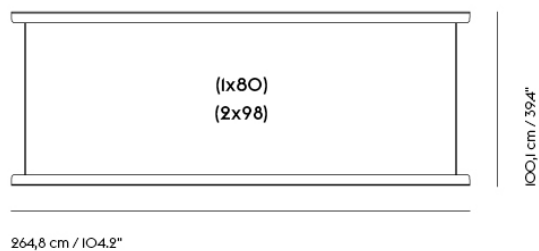

Shipper Colli	1
Gross Weight (kg)	33
Net Weight (kg)	28.02
Warranty Period	10 years

Pattern No.	Color	Contract Price	Lead Time
Ready-To-Ship US Warehouse			
MINSFRMS809898	Black - 1 x 80 + 2 x 98	USD 866.00	-
Extras			
99899	99899		-
99900	99900		-

IN SITU MODULAR SOFA / FRAME SECTION (2 X 80 + 1 X 98)

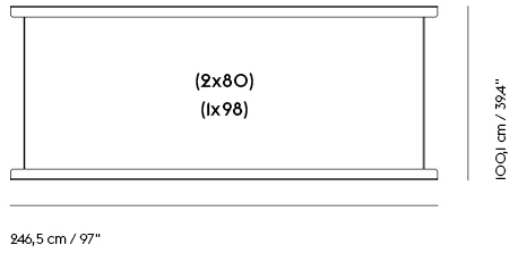

Shipper Colli 1
 Gross Weight (kg) 31.2
 Net Weight (kg) 26.22
 Warranty Period 10 years

Pattern No.	Color	Contract Price	Lead Time
Ready-To-Ship US Warehouse			
MINSFRMS808098	Black - 2 x 80 + 1 x 98	USD 866.00	-
Extras			
99899	99899		-
99900	99900		-

IN SITU MODULAR SOFA / CHAISE LOUNGE FRAME SECTION (1 X 98)

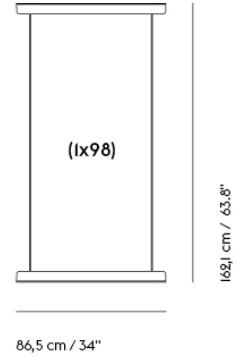

Shipper Colli 1
Gross Weight (kg) 19.7
Net Weight (kg) 16.04
Warranty Period 10 years

Pattern No.	Color	Contract Price	Lead Time
Ready-To-Ship US Warehouse			
MINSFRML98	Black - 1 x 98 Chaise Lounge	USD 289.00	-
Extras			
99899	99899		-
99900	99900		-

IN SITU MODULAR SOFA / CORNER FRAME SECTION (1 X 98)

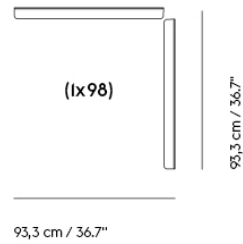

Shipper Colli 1
Gross Weight (kg) 10.8
Net Weight (kg) 8.56
Warranty Period 10 years

Pattern No.	Color	Contract Price	Lead Time
Ready-To-Ship US Warehouse			
MINSFRMC98	Black - 1 x 98 Corner	USD 289.00	-
Extras			
99899	99899		-
99900	99900		-

IN SITU MODULAR SOFA LINKING BRACKET



Shipper Colli	1
Gross Weight (kg)	1.6
Net Weight (kg)	1.46
Warranty Period	5 years

Pattern No.	Color	Contract Price	Lead Time
Ready-To-Ship US Warehouse			
MLDINSU	Black	USD 39.00	-
Extras			
99900	99900		-

IN SITU MODULAR SOFA / FRAME CONFIGURATION - 2-SEATER

Shipper Colli	1
Gross Weight (kg)	21.9
Net Weight (kg)	18.24
Warranty Period	10 years

Pattern No.	Color	Contract Price	Lead Time
-------------	-------	----------------	-----------

Ready-To-Ship US Warehouse

MINS PF2C1	2-Seater Frame Configuration 1	USD 576.00	-
MINS PF2C2	2-Seater Frame Configuration 2	USD 576.00	-
MINS PF2C3	2-Seater Frame Configuration 3	USD 576.00	-
MINS PF2C4	2-Seater Frame Configuration 4	USD 614.00	-
MINS PF2C5	2-Seater Frame Configuration 5	USD 614.00	-
MINS PF2C6	2-Seater Frame Configuration 6	USD 614.00	-
MINS PF2C7	2-Seater Frame Configuration 7	USD 614.00	-

Extras

99899	99899	-
99900	99900	-

IN SITU MODULAR SOFA / FRAME CONFIGURATION - 3-SEATER

Shipper Colli	1
Gross Weight (kg)	29.9
Net Weight (kg)	24.92
Warranty Period	10 years

Pattern No.	Color	Contract Price	Lead Time
Ready-To-Ship US Warehouse			
MINS PF3C1	3-Seater Frame Configuration 1	USD 866.00	-
MINS PF3C2	3-Seater Frame Configuration 2	USD 866.00	-
MINS PF3C3	3-Seater Frame Configuration 3	USD 866.00	-
MINS PF3C4	3-Seater Frame Configuration 4	USD 866.00	-
MINS PF3C5	3-Seater Frame Configuration 5	USD 866.00	-
MINS PF3C6	3-Seater Frame Configuration 6	USD 902.00	-
MINS PF3C7	3-Seater Frame Configuration 7	USD 902.00	-
MINS PF3C8	3-Seater Frame Configuration 8	USD 902.00	-
MINS PF3C9	3-Seater Frame Configuration 9	USD 902.00	-
Extras			
99899	99899		-
99900	99900		-

IN SITU MODULAR SOFA / FRAME CONFIGURATION - 4-SEATER

Shipper Colli	3
Gross Weight (kg)	45.4
Net Weight (kg)	37.94
Warranty Period	10 years

Pattern No.	Color	Contract Price	Lead Time
Ready-To-Ship US Warehouse			
MINSPP4C1	4-Seater Frame Configuration 1	USD 1,206.00	-
MINSPP4C2	4-Seater Frame Configuration 2	USD 1,206.00	-
MINSPP4C3	4-Seater Frame Configuration 3	USD 1,206.00	-
MINSPP4C4	4-Seater Frame Configuration 4	USD 1,206.00	-
MINSPP4C5	4-Seater Frame Configuration 5	USD 1,206.00	-
Extras			
99899	99899		-
99900	99900		-

IN SITU MODULAR SOFA / FRAME CONFIGURATION - CORNER

Shipper Colli 5
 Gross Weight (kg) 57.8
 Net Weight (kg) 47.96
 Warranty Period 10 years

Pattern No.	Color	Contract Price	Lead Time
Ready-To-Ship US Warehouse			
MINSPFCC1	Corner Frame Configuration 1	USD 1,570.00	-
MINSPFCC2	Corner Frame Configuration 2	USD 1,570.00	-
MINSPFCC3	Corner Frame Configuration 3	USD 1,570.00	-
MINSPFCC4	Corner Frame Configuration 4	USD 1,570.00	-
MINSPFCC5	Corner Frame Configuration 5	USD 1,570.00	-
MINSPFCC6	Corner Frame Configuration 6	USD 1,836.00	-
MINSPFCC7	Corner Frame Configuration 7	USD 1,836.00	-
MINSPFCC8	Corner Frame Configuration 8	USD 2,095.00	-
MINSPFCC9	Corner Frame Configuration 9	USD 2,095.00	-
Extras			
99899	99899		-
99900	99900		-

IN SITU MODULAR SOFA INDIVIDUAL PARTS



All Variants

	Description	Pattern No.	Contract Price
In Situ Frames - Straight	1x80	M-INSFRM-S-80	289
	1x98	M-INSFRM-S-98	289
	2x80	M-INSFRM-S-8080	576
	2x98	M-INSFRM-S-9898	576
	3x80	M-INSFRM-S-808080	866
	1x80 + 1x98	M-INSFRM-S-8098	576
	1x80 + 2x98	M-INSFRM-S-809898	866
	2x80 + 1x98	M-INSFRM-S-808098	866
In Situ Frames - Chaise	1x98	M-INSFRM-L-98	289
In Situ Frames - Corner	1x98	M-INSFRM-C-98	289
In Situ Linking Bracket		M-LD-INSU	39

		Upholstery Grades									
		COM									
	Description	Pattern No.	A	B	C	E	R	T	U	V	W
In Situ Armrest Module	Left (A80)	M-INSAM-L	2,256	2,361	2,515	2,571	3,621	4,041	4,566	4,881	5,301
	Right (B80)	M-INSAM-R	2,256	2,361	2,515	2,571	3,621	4,041	4,566	4,881	5,301
In Situ Center Module	Centre (C80)	M-INSCTM	1,570	1,836	1,941	2,046	2,571	2,830	3,145	3,411	3,726
In Situ Ottoman Module	Ottoman (D80)	M-INSOTM	881	971	1,013	1,101	1,731	1,941	2,200	2,361	2,571
In Situ Corner Module	Corner (E98)	M-INSCOM	2,515	2,781	2,830	2,886	4,041	4,356	4,881	5,245	5,560
In Situ Open-Ended Module	Left (F98)	M-INSOEM-L	1,731	1,941	2,095	2,256	3,096	3,355	3,831	4,146	4,405
	Right (G98)	M-INSOEM-R	1,731	1,941	2,095	2,256	3,096	3,355	3,831	4,146	4,405
In Situ Armrest Lounge Module	Left (H98)	M-INSALM-L	2,830	3,145	3,355	3,516	5,245	5,721	6,295	6,820	7,296
	Right (I98)	M-INSALM-R	2,830	3,145	3,355	3,516	5,245	5,721	6,295	6,820	7,296
In Situ Cushion	27.6" x 11.8"	M-INSCUS-2610	167	198	236	257	394	450	597	555	587
	27.6" x 19.7"	M-INSCUS-2618	226	236	289	310	660	719	929	950	982

Upholstery Options

A	B	C	E	R	T	U	V	W
Ocean (M161)*	Colline (M5416) Fiord (M155) Grain (M12659) Manner (M12665) Re-Wool (M4586) Sabi (M8404)	Hallingdal (M146)	Acca (M12660) Beck (M6376) Divina (M150) Divina MD (M147) Divina Melange (M135) Ecriture (M10767) Hearth (M12664) Planum (M5904) Twill Weave (M142) Vidar (M158)	Easy Leather (M141)	Refine Leather (M136)	Endure Leather (M137)	Grace Leather (M12374)	Allure Leather (M12375)
					*Notes: Ocean - Color 3, 21, 32, 50, 52, 80 & 601 Clay - Color 1, 2, 3, 4, 5, 6, 7, 8, 9, 10, 11, 12, 13, 14, 15, 16 & 17			

HOW TO CONFIGURE

See the In Situ intro page for how to configure or use the online planner on: planner.muuto.com/in-situ

LINEAR SYSTEM

“The Linear System Series places people at its center, being a place to meet, to collaborate or to work in focused solitude. The design process was about creating a system that made for intimately welcoming atmospheres, enhanced by the expression and functionality of its lighting and accessories. The Linear System Series brings feelings of home into larger spaces to give the user a sense of belonging. The extensive selection of lighting and accessories means that the Linear System Series can be configured and reshuffled for any purpose, marrying the ideas of aesthetics and function into one.”

— Thomas Bentzen



Designed by	Thomas Bentzen / 2020
Environment	Indoor
Country of Production	Table in Latvia / Power Outlet in England / Power Kit & Cable Tray in Germany
Assembly Required	Yes
Description	<p>The Linear System Series brings a new perspective to the evolving needs of modern spaces. The Linear System Table is a simple yet refined table with subtle details and references to the Scandinavian design heritage. Its legs are cut into half-circles and joined with the table for a light expression while the slender overhang at both ends of the table makes for a refined expression. The Linear System Table is available as a freestanding table to be used on its own, as predesigned configurations or as Middle and End Modules that can be configured to the exact needs of your space. Screens and trays are available in various sizes and are mounted into the ridge that runs down the tabletop, allowing for them to be shuffled around as functional and aesthetic needs evolve. Visit our Product Planner to explore the possible configurations: planner.muuto.com/linear</p> <p>Please note: the Integrated Power for Linear System Series is only available for contract market orders.</p>
Material	<p>Table: Tabletop comes in Oak veneer, black version in Ash veneer, Black Nanolaminate or White Laminate. Black Nanolaminate and White Laminate has an ABS edge. It is not possible to mix multiple tabletop finishes in a Linear System configuration. Table frame in veneered plywood and legs in Solid Oak. Felt glides included.</p> <p>Oak Veneer color variations: The Oak Veneer tabletops of the Linear System Series are made using high-quality mix-matched veneer to avoid differences in the visual appearance from tabletop to tabletop. However, wood is a natural material, and this means that slight variations can occur from table to table.</p> <p>Accessories: Screens are in solid oak and veneered MDF with powder coated aluminum fixing knobs. Possibility of upholstery on Screens. Tray 170 cm is in solid oak and veneered MDF, Tray Ø24 and Tray Ø36 are solid oak, all with powder coated aluminum fixing knobs. Cable Tray in PET felt.</p>
Cleaning & Care	<p>Wood & Veneer Surfaces: Clean the table with a damp cloth. If necessary, only use a mild detergent or washing up liquid and not concentrated. Always wipe with a dry cloth afterwards. To minimize the risk of stains and marks, liquid, grease etc. should be removed straight away.</p> <p>Laminate Surface: Clean the table with a damp cloth. If necessary, use a mild detergent or washing up liquid and not concentrated. Always wipe with a dry cloth afterwards. To minimize the risk of stains and marks, liquids, grease etc. should be removed straight away.</p> <p>Warning for Power System: Disconnect from main supply before cleaning. Clean with soft dry cloth only. Always switch off electricity supply before cleaning.</p>

EN 15372:2016 - L3

VOC CDPH 01350 &
VOC BIFMA X7.1*

TESTS & CERTIFICATIONS

Linear System Table:

Severe use. Furniture – Strength, durability and safety.
Requirements for non-domestic tables.

Linear System Table incl. screens, trays, lamps and power outlet is VOC CDPH 01350 and VOC Bifma X7.1 tested.

*Please note that the black versions of the Linear System Table and Linear System Accessories is only compliant for private office use.

The Linear System Series brings a new perspective to the evolving needs of the modern workspaces, hospitality settings and educational institutions through its configurable design across tables, lighting, screens and trays alongside its custom integrated power solution, allowing one to tailor the design to the exact needs of any space.

Option A — Choose between one of our predesigned table configurations and simply add your desired lamps and accessories.

Option B — Create your own configuration from scratch and add lamps and accessories from there.

Option A — Predesigned Table Configurations

STEP 1 . TABLES

Select either the Linear System Table or one of three Linear System Table Configurations.

Note
Different finishes of tabletops cannot be mixed as they might vary in thickness.

Linear System Table

Height — 74 cm / 29.1"
Table top width — 142 cm / 55.9"
Total width — 146.9 cm / 57.8"
Total length — 240 cm / 94.5"
No of Persons — 4-6

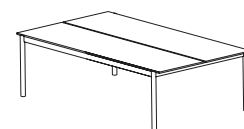

240 cm / 94.5"

Linear System Table Configuration 1

Height — 74 cm / 29.1"
Table top width — 142 cm / 55.9"
Total width — 146.9 cm / 57.8"
Total length — 360 cm / 141.7"
No of Persons — 6-8

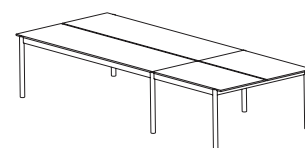

240 cm / 94.5" 120 cm / 47.2"

Linear System Table Configuration 2

Height — 74 cm / 29.1"
Table top width — 142 cm / 55.9"
Total width — 146.9 cm / 57.8"
Total length — 480 cm / 189"
No of Persons — 8-12

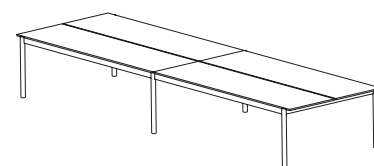

240 cm / 94.5" 240 cm / 94.5"

Linear System Table Configuration 3

Height — 74 cm / 29.1"
Table top width — 142 cm / 55.9"
Total width — 146.9 cm / 57.8"
Total length — 720 cm / 283.5"
No of Persons — 12-18

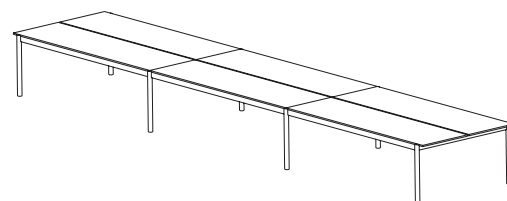

240 cm / 94.5" 240 cm / 94.5" 240 cm / 94.5"

OPTION A

1. TABLES / 2. ACCESSORIES / 3. LIGHTING / 4. TABLE POWER OUTLET / 5. INTEGRATED POWER / 6. CABLE TRAY

STEP 2. ACCESSORIES

Trays

Add your desired number of Linear System Trays.

Note
Trays must be mounted at least 5 cm / 2" from the table edge.

Linear System Tray — Ø24 cm / 9.5"

Height — 15,6 cm / 6.2"
Diameter — 24 cm / 9.5"



Linear System Tray — Ø36 cm / 14.2"

Height — 9,6 cm / 3.8"
Diameter — 36 cm / 14.2"



Linear System Tray — 170 cm / 66.9"

Height — 15 cm / 5.9"
Width — 21 cm / 8.3"
Length — 170 cm / 66.9"

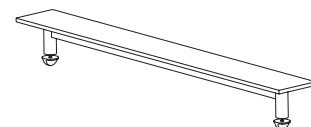

Screens

Add your desired number of Linear System Screens.

Note
We recommend that screens are mounted to the table. They must be placed at least 5 cm / 2" from the table edge.

Linear System Screen — 75 cm / 29.5"

Height — 35 cm / 13.8"
Width — 15 cm / 5.9"
Length — 75 cm / 29.5"

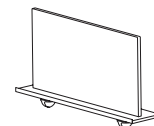

Linear System Screen — 125 cm / 49.2"

Height — 35 cm / 13.8"
Width — 15 cm / 5.9"
Length — 125 cm / 49.2"

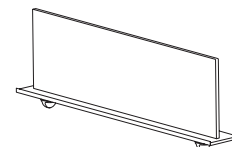

Linear System Screen — 178 cm / 70.1"

Height — 35 cm / 13.8"
Width — 15 cm / 5.9"
Length — 178 cm / 70.1"

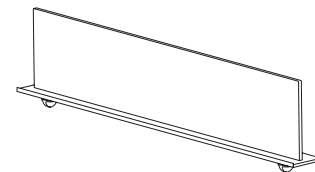

Note
Please note that only the Linear System Screen 125 cm / 49.2" can be mounted across the table.

Example

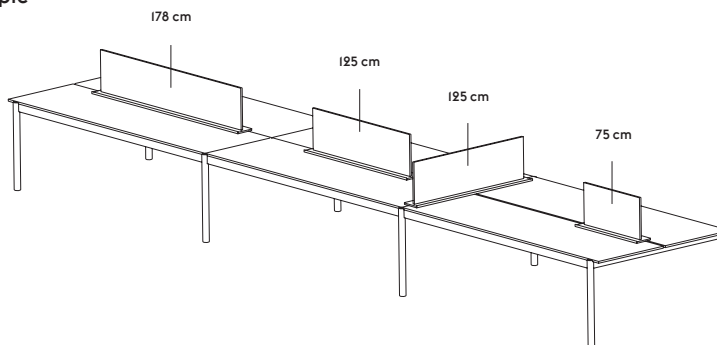

OPTION A

1. TABLES / 2. ACCESSORIES / 3. LIGHTING / 4. TABLE POWER OUTLET / 5. INTEGRATED POWER / 6. CABLE TRAY

STEP 3. LIGHTING

Add your desired number of Linear Lamps.

Note
The Linear Table Lamp has one USB-C plug.

Linear Table Lamp

Height — 36,5 cm / 14.4"
Width — 23,2 cm / 9.1"
Depth — 16,5 cm / 6.5"



Note
Linear Mounted Lamp must be mounted at least 5 cm / 2" from the table edge.

Please be aware that the Linear Mounted Lamp and Table Power Outlet, both designed for the Linear System Series, have a special power solution with special plugs.

Linear Mounted Lamp — 23,2 cm / 9.1"

Height — 36,5 cm / 14.4"
Width — 23,2 cm / 9.1"
Depth — 10,7 cm / 4.2"



Linear Mounted Lamp — 209,2 cm / 82.4"

Height — 70,7 cm / 27.8"
Width — 209,2 cm / 82.4"
Depth — 10,7 cm / 4.2"



Linear Pendant Lamp — 87,2 cm / 34.3"

Height — 5,4 cm / 2.1"
Width — 87,2 cm / 34.3"
Depth — 10,7 cm / 4.2"



Linear Pendant Lamp — 169,2 cm / 66.6"

Height — 5,4 cm / 2.1"
Width — 169,2 cm / 66.6"
Depth — 10,7 cm / 4.2"



STEP 4. TABLE POWER OUTLETS

Specify your desired number of Table Power Outlets. Each Table Power Outlet has two outlets (one at each end) and one USB-A and USB-C plug to which standard plugs can be connected.

Note
Linear System Table Power Outlet must be mounted at least 5 cm / 2" from the table edge and requires a power kit for functionality.

Linear System Table Power Outlet — US

Height — 7 cm / 2.8"
Width — 7 cm / 2.8"
Length — 18 cm / 7.1"

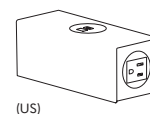

(US)

OPTION A

1. TABLES / 2. ACCESSORIES / 3. LIGHTING / 4. TABLE POWER OUTLET / 5. INTEGRATED POWER / 6. CABLE TRAY

STEP 5. INTEGRATED POWER FOR MOUNTED LAMPS & TABLE POWER OUTLETS

If you'd like to add the Mounted Lamp(s) or Table Power Outlet(s), select the Table Power Kit for the Linear System Table or one of the three Power Configurations that match your selected Linear System Table Configuration.

Note
Each Distribution Block has four outlets to which up to four Linear Mounted Lamps or Linear System Table Power Outlets can be plugged in.

Distribution Block — 4-way

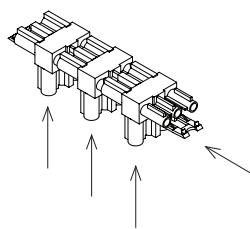

US cable
500 cm / 197" cable

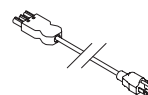

Linear System Table

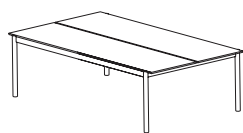

Linear System Power

Power Kit (1 pcs)
500 cm / 197" cable (US)
Distribution Block

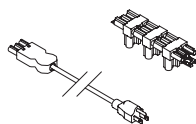

Linear System Table Configuration 1

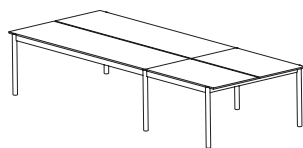

Linear System Power

Power Kit (1 pcs)
500 cm / 197" cable (US)
Distribution Block

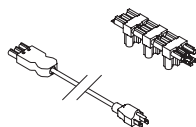

Linear System Table Configuration 2

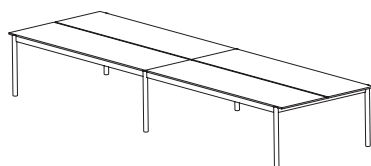

Linear System Power Configuration 2

Power Kit (1 pcs)
500 cm / 197" cable (US)
Distribution Block

Power Kit (1 pcs)
500 cm / 197" cable (US)
Distribution Block

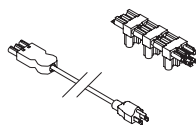

+

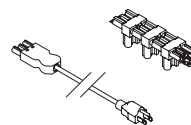

Linear System Table Configuration 3

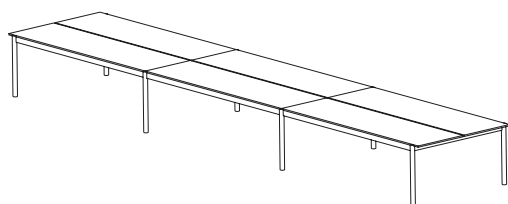

Linear System Power Configuration 3

Power Kit (1 pcs)
500 cm / 197" cable (US)
Distribution Block

Power Kit (1 pcs)
500 cm / 197" cable (US)
Distribution Block

Power Kit (1 pcs)
500 cm / 197" cable (US)
Distribution Block

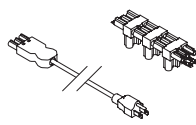

+

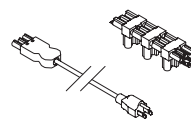

+

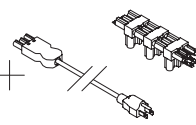

OPTION A
1. TABLES / 2. ACCESSORIES / 3. LIGHTING / 4. TABLE POWER OUTLET / 5. INTEGRATED POWER / 6. CABLE TRAY

Note
The Integrated Power for Linear System Series has unique internal plugs to provide a slim and discreet look. This means that you cannot connect a standard plug to the power without using the Linear Table Power Outlet or changing the standard plug to a matching plug, being the Wieland GSTI8I3 plug.

The Linear Mounted Lamps must be connected to the integrated Power Kit.

Wieland GSTI8I3 plug

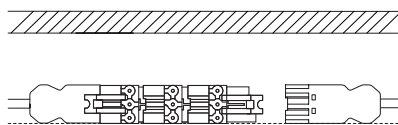

Standard plug (US)

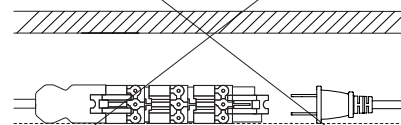

1. Connecting using the Wieland GSTI8I3 plug

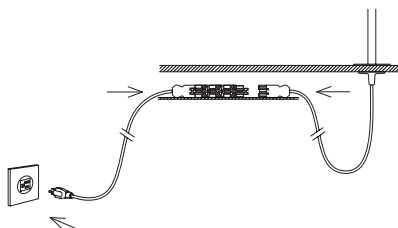

2. Connecting using a standard plug to the Linear Table Power Outlet

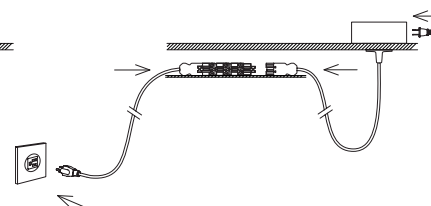

LINEAR TABLE LAMP ONLY

The Linear Table Lamp can either be connected to a standard wall plug or the Table Power Outlet.

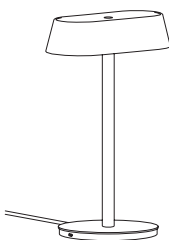

Standard plug

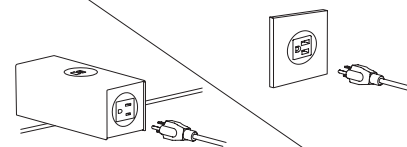

Linear Table Power Outlet

Alternatively, you can connect it to the integrated Power Kit by replacing the plug with a custom Wieland GSTI8I3 plug that is included with the lamp. Kindly refer to the Linear Table Lamp manual for instructions.

Integrated Table Power Kit (Wieland GSTI8I3 plug)

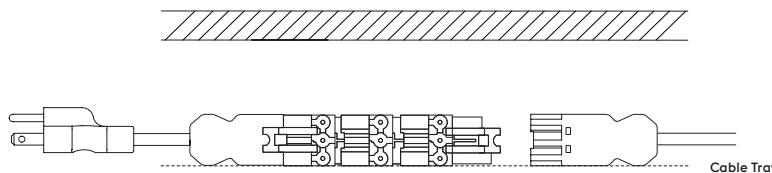

OPTION A

1. TABLES / 2. ACCESSORIES / 3. LIGHTING / 4. TABLE POWER OUTLET / 5. INTEGRATED POWER / 6. CABLE TRAY

STEP 6. CABLE TRAYS

We recommend using 1 Cable Tray for the End Module – 120 cm / 47.2" and up to 3 Cable Trays for the Linear Table, End Module – 240 cm / 94.2" and the Middle Module – 240 cm / 94.2".

Linear System Cable Tray

Height – 3 cm / 1.2"
 Width – 22 cm / 8.7"
 Depth – 60 cm / 23.7"

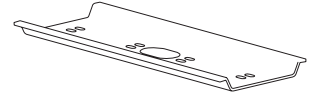

Example:

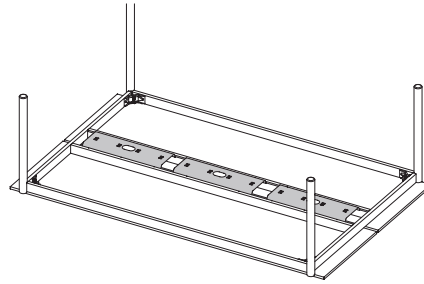

Linear System Table – 240 cm / 94.5"

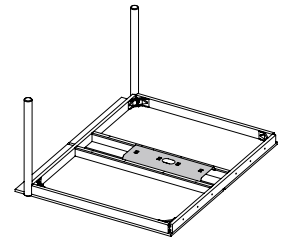

Linear System End Module – 120 cm / 47.2"

OPTION A

1. TABLES / 2. ACCESSORIES / 3. LIGHTING / 4. TABLE POWER OUTLET / 5. INTEGRATED POWER / 6. CABLE TRAY

Option B — Create your own configuration

STEP 1 . TABLES

A)

A configuration must always have End Modules in each end.

Start by defining the total length of your desired configuration, then select two table ends.

Note
Different finishes of tabletops cannot be mixed as they might vary in thickness.

Linear System End Module — 240 cm / 94.5"

Height — 74 cm / 29.1"
Width — 146,9 cm / 57.8"
Length — 240 cm / 94.5"
No of Persons — 4-6



Linear System End Module — 120 cm / 47.2"

Height — 74 cm / 29.1"
Width — 146,9 cm / 57.8"
Length — 120 cm / 47.2"
No of Persons — 2



B)

Next, add the second, and final, End Module or your desired number of Middle Modules, only available in 240 cm / 94.5".

Note
Please note that it is not possible to connect more than two End Modules.

Linear System Middle Module — 240 cm / 94.5"

Width — 146,9 cm / 57.8"
Length — 240 cm / 94.5"
No of Persons — 4-6



C)

Next, you must order 1 set of Connecting Legs every time two modules are connected.

Linear System Connecting Legs

Height — 74 cm / 29.1"

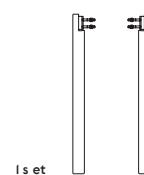

If you'd like a configuration of one End Module — 240 cm / 94.5" and one Middle Module — 240 cm / 94.5" and one End Module — 240 cm / 94.5", you must order two sets of Connecting Legs, as shown in the illustration.

Example

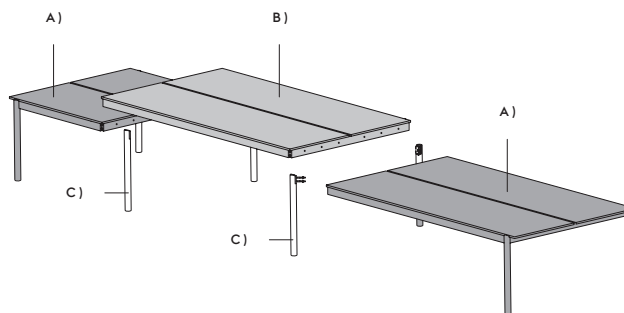

OPTION B

1. TABLES / 2. ACCESSORIES / 3. LIGHTING / 4. TABLE POWER OUTLET / 5. INTEGRATED POWER / 6. CABLE TRAY

STEP 2. ACCESSORIES

Trays

Add your desired number of Linear System Trays.

Note
Trays must be mounted at least 5 cm / 2" from the table edge.

Linear System Tray — Ø24 cm / 9.5"

Height — 15,6 cm / 6.2"
Diameter — 24 cm / 9.5"



Linear System Tray — Ø36 cm / 14.2"

Height — 9,6 cm / 3.8"
Diameter — 36 cm / 14.2"



Linear System Tray — 170 cm / 66.9"

Height — 15 cm / 5.9"
Width — 21 cm / 8.3"
Length — 170 cm / 66.9"

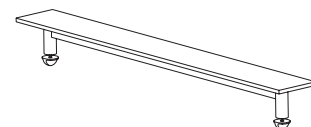

Screens

Add your desired number of Linear System Screens.

Note
We recommend that screens are mounted to the table. They must be placed at least 5 cm / 2" from the table edge.

Linear System Screen — 75 cm / 29.5"

Height — 35 cm / 13.8"
Width — 15 cm / 5.9"
Length — 75 cm / 29.5"

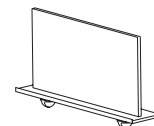

Linear System Screen — 125 cm / 49.2"

Height — 35 cm / 13.8"
Width — 15 cm / 5.9"
Length — 125 cm / 49.2"

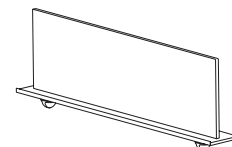

Linear System Screen — 178 cm / 70.1"

Height — 35 cm / 13.8"
Width — 15 cm / 5.9"
Length — 178 cm / 70.1"

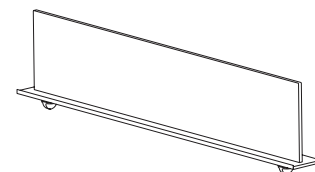

Note
Please note that only the Linear System Screen 125 cm / 49.2" can be mounted across the table.

Example

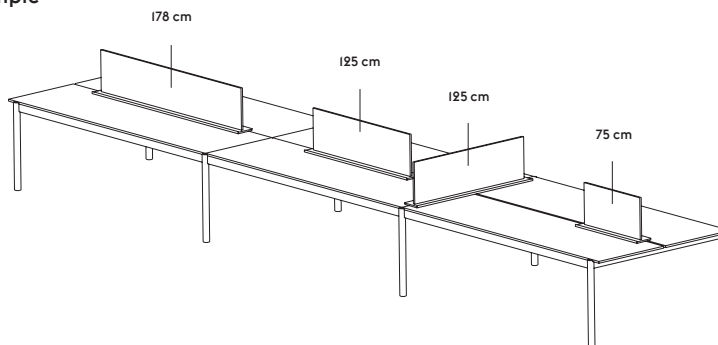

OPTION B
1. TABLES / 2. ACCESSORIES / 3. LIGHTING / 4. TABLE POWER OUTLET / 5. INTEGRATED POWER / 6. CABLE TRAY

STEP 3. LIGHTING

Add your desired number of Linear Lamps.

Note
The Linear Table Lamp has one USB-C plug.

Linear Table Lamp

Height — 36,5 cm / 14.4"
Width — 23,2 cm / 9.1"
Depth — 16,5 cm / 6.5"



Note
Linear Mounted Lamp must be mounted at least 5 cm / 2" from the table edge.

Please be aware that the Linear Mounted Lamp and Table Power Outlet, both designed for the Linear System Series, have a special power solution with special plugs.

Linear Mounted Lamp — 23,2 cm / 9.1"

Height — 36,5 cm / 14.4"
Width — 23,2 cm / 9.1"
Depth — 10,7 cm / 4.2"

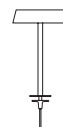

Linear Mounted Lamp — 209,2 cm / 82.4"

Height — 70,7 cm / 27.8"
Width — 209,2 cm / 82.4"
Depth — 10,7 cm / 4.2"



Linear Pendant Lamp — 87,2 cm / 34.3"

Height — 5,4 cm / 2.1"
Width — 87,2 cm / 34.3"
Depth — 10,7 cm / 4.2"



Linear Pendant Lamp — 169,2 cm / 66.6"

Height — 5,4 cm / 2.1"
Width — 169,2 cm / 66.6"
Depth — 10,7 cm / 4.2"



STEP 4. TABLE POWER OUTLETS

Specify your desired number of Table Power Outlets. Each Table Power Outlet has two outlets (one at each end) and one USB-A and USB-C plug to which standard plugs can be connected.

Note
Linear System Table Power Outlet must be mounted at least 5 cm / 2" from the table edge and requires a power kit for functionality.

Linear System Table Power Outlet — US

Height — 7 cm / 2.8"
Width — 7 cm / 2.8"
Length — 18 cm / 7.1"

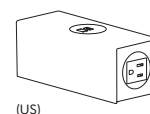

(US)

OPTION B

1. TABLES / 2. ACCESSORIES / 3. LIGHTING / 4. TABLE POWER OUTLET / 5. INTEGRATED POWER / 6. CABLE TRAY

STEP 5. INTEGRATED POWER FOR MOUNTED LAMPS & TABLE POWER OUTLET

If you'd like to add the Mounted Lamp(s) and/or Table Power Outlets, select the Power Kit.

If you add a End Module or a Middle Module — 240 cm / 94.5" add a Power Kit for each table added.

Power Kit (1 pcs)

500 cm / 197" cable (US)
Distribution Block

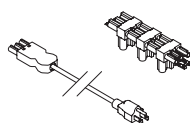

Example 1

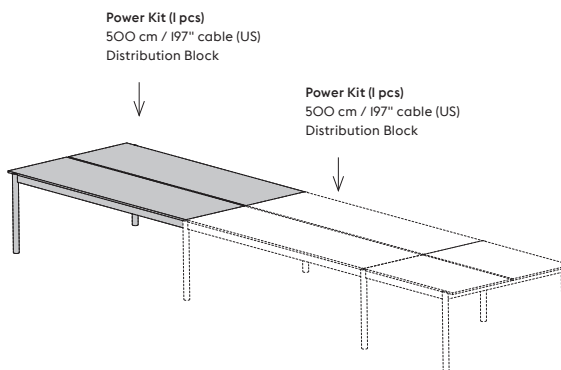

Example 2

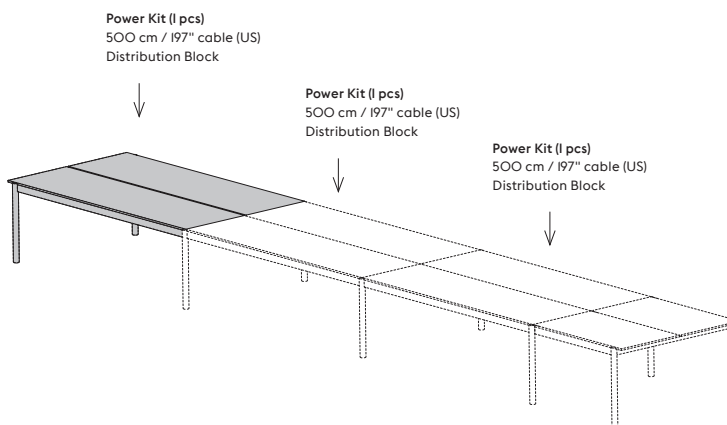

OPTION B

1. TABLES / 2. ACCESSORIES / 3. LIGHTING / 4. TABLE POWER OUTLET / 5. INTEGRATED POWER / 6. CABLE TRAY

LINEAR TABLE LAMP ONLY

The Linear Table Lamp can either be connected to a standard wall plug or the Table Power Outlet.

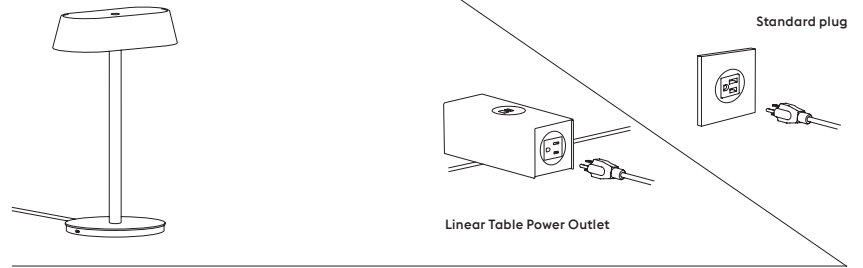

Alternatively, you can connect it to the integrated Table Power Kit by replacing the plug with a custom Wieland GST1813 plug that is included with the lamp. Kindly refer to the Linear Table Lamp manual for instructions.

Integrated Table Power Kit (Wieland GST1813 plug)

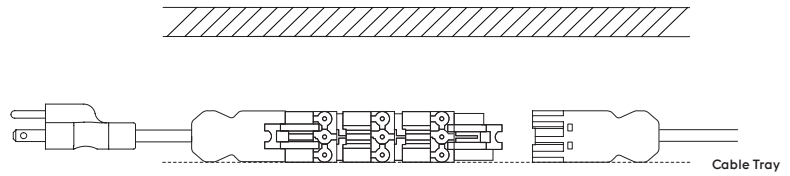

STEP 6. CABLE TRAYS

We recommend using 1 C cable Tray for the End Module – 120 cm / 47.2" and up to 3 Cable Trays for the Linear Table, End Module – 240 cm / 94.2" and the Middle Module – 240 cm / 94.2".

Linear System Cable Tray

Height – 3 cm / 1.2"
Width – 22 cm / 8.7"
Depth – 60 cm / 23.7"

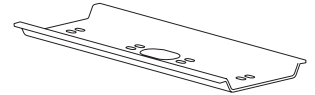

Example:

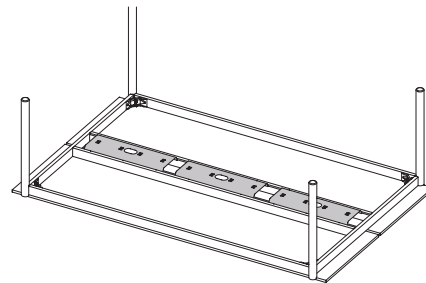

Linear System Table – 240 cm / 94.5"

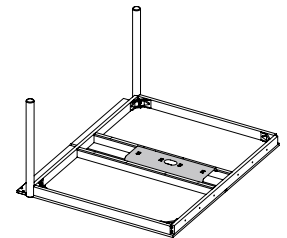

Linear System End Module – 120 cm / 47.2"

OPTION B

1. TABLES / 2. ACCESSORIES / 3. LIGHTING / 4. TABLE POWER OUTLET / 5. INTEGRATED POWER / 6. CABLE TRAY

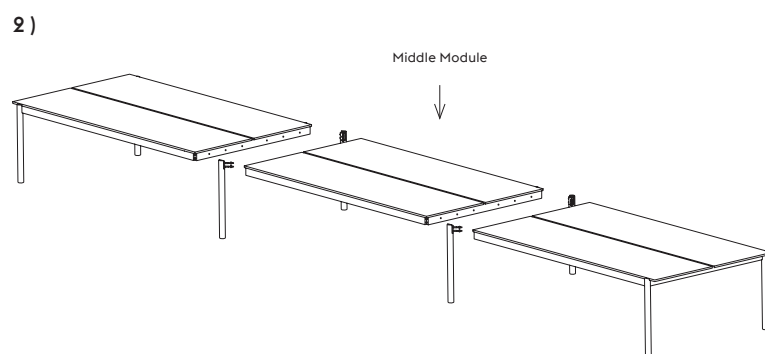
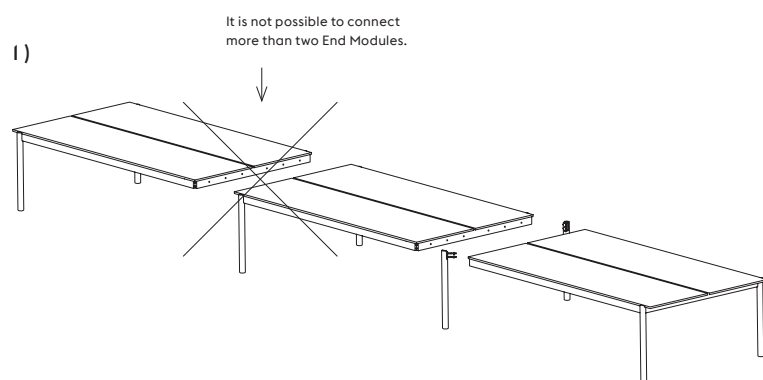

LINEAR SYSTEM MIDDLE MODULE / 142 X 240 CM / 55.9 X 94.5"

Shipper Colli 2
 Gross Weight (kg) 63.15
 Net Weight (kg) 57.65
 Warranty Period 5 years

Pattern No.	Color	Contract Price	Lead Time
Ready-To-Ship US Warehouse			
MLINSYTMM-WHIT-OAK	White Laminate/White ABS/Oak ***	USD 2,781.00	-
MLINSYTMM-BLCK-BLCK	Black Nanolaminate/Black ABS/Black	USD 3,516.00	-
MLINSYTMM-BLCK-OAK	Black Nanolaminate/Black ABS/Oak	USD 3,516.00	-
MLINSYTMM-OAK-OAK	Oak Veneer/Oak	USD 2,886.00	-
MLINSYTMM-BASH-BLCK	Black Lacquered Ash Veneer/Black	USD 2,886.00	-

Shipper Colli 2
Gross Weight (kg) 69.057
Net Weight (kg) 61.8
Warranty Period 5 years

Pattern No.	Color	Contract Price	Lead Time
Ready-To-Ship US Warehouse			
MLINSYTTM-WHIT-OAK	White Laminate/White ABS/Oak ***	USD 3,145.00	-
MLINSYTTM-BLCK-BLCK	Black Nanolaminate/Black ABS/Black	USD 3,880.00	-
MLINSYTTM-BLCK-OAK	Black Nanolaminate/Black ABS/Oak	USD 3,880.00	-
MLINSYTTM-OAK-OAK	Oak Veneer/Oak	USD 3,355.00	-
MLINSYTTM-BASH-BLCK	Black Lacquered Ash Veneer/Black	USD 3,355.00	-

LINEAR SYSTEM TABLE / CONFIGURATION I - W: 142 CM / 55.9"

Shipper Colli	5
Gross Weight (kg)	109.886
Net Weight (kg)	93.895
Warranty Period	5 years

Pattern No.	Color	Contract Price	Lead Time
Ready-To-Ship US Warehouse			
MLINSYTC1-WHIT-OAK	White Laminate/White ABS/Oak	USD 4,671.00	-
MLINSYTC1-BLCK-BLCK	Black Nanolaminate/Black ABS/Black	USD 5,875.00	-
MLINSYTC1-BLCK-OAK	Black Nanolaminate/Black ABS/Oak	USD 5,875.00	-
MLINSYTC1-OAK-OAK	Oak Veneer/Oak	USD 5,245.00	-
MLINSYTC1-BASH-BLCK	Black Lacquered Ash Veneer/Black	USD 5,245.00	-

LINEAR SYSTEM TABLE / CONFIGURATION 2 - W: 142 CM / 55.9"

Shipper Colli 5
 Gross Weight (kg) 141.512
 Net Weight (kg) 122.82
 Warranty Period 5 years

Pattern No.	Color	Contract Price	Lead Time
Ready-To-Ship US Warehouse			
MLINSYTC2-WHIT-OAK	White Laminate/White ABS/Oak ***	USD 5,875.00	-
MLINSYTC2-BLCK-BLCK	Black Nanolaminate/Black ABS/Black	USD 7,555.00	-
MLINSYTC2-BLCK-OAK	Black Nanolaminate/Black ABS/Oak	USD 7,555.00	-
MLINSYTC2-OAK-OAK	Oak Veneer/Oak	USD 6,561.00	-
MLINSYTC2-BASH-BLCK	Black Lacquered Ash Veneer/Black	USD 6,561.00	-

LINEAR SYSTEM END MODULE / 142 X 120 CM / 55.9 X 47.2"

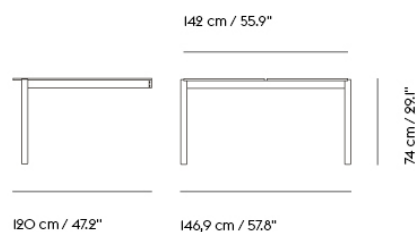
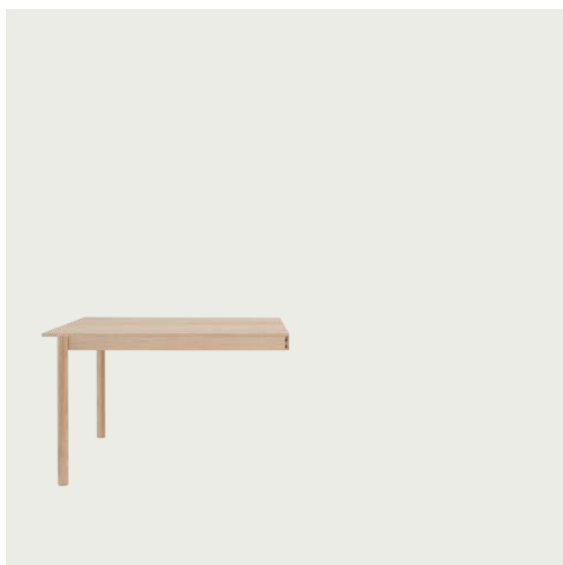

Shipper Colli	2
Gross Weight (kg)	36.371
Net Weight (kg)	31.475
Warranty Period	5 years

Pattern No.	Color	Contract Price	Lead Time
Ready-To-Ship US Warehouse			
MLINSYTEM5647-WHIT-OAK	White Laminate/White ABS/Oak ***	USD 1,836.00	-
MLINSYTEM5647-BLCK-BLCK	Black Nanolaminate/Black ABS/Black	USD 2,361.00	-
MLINSYTEM5647-BLCK-OAK	Black Nanolaminate/Black ABS/Oak	USD 2,361.00	-
MLINSYTEM5647-OAK-OAK	Oak Veneer/Oak	USD 1,836.00	-
MLINSYTEM5647-BASH-BLCK	Black Lacquered Ash Veneer/Black	USD 1,836.00	-

**LINEAR SYSTEM END MODULE / 142 X
240 CM / 55.9 X 94.5"**

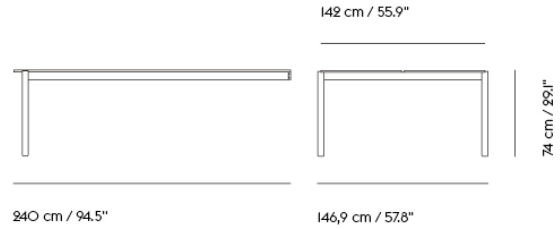

Shipper Colli 2
Gross Weight (kg) 64.806
Net Weight (kg) 59.5
Warranty Period 5 years

Pattern No.	Color	Contract Price	Lead Time
Ready-To-Ship US Warehouse			
MLINSYTEM5695-WHIT-OAK	White Laminate/White ABS/Oak ***	USD 3,355.00	-
MLINSYTEM5695-BLCK-BLCK	Black Nanolaminate/Black ABS/Black	USD 3,831.00	-
MLINSYTEM5695-BLCK-OAK	Black Nanolaminate/Black ABS/Oak	USD 3,831.00	-
MLINSYTEM5695-OAK-OAK	Oak Veneer/Oak	USD 3,355.00	-
MLINSYTEM5695-BASH-BLCK	Black Lacquered Ash Veneer/Black	USD 3,355.00	-

LINEAR SYSTEM CONNECTING LEGS / H: 74 CM

Shipper Colli 1
Gross Weight (kg) 3.6
Net Weight (kg) 3
Warranty Period 5 years

Pattern No.	Color	Contract Price	Lead Time
Ready-To-Ship US Warehouse			
MLINSYTCL-BLCK	Black	USD 310.00	-
MLINSYTCL-OAK	Oak	USD 310.00	-

LINEAR SYSTEM CONFIGURATIONS / CONFIGURATION I - W: 142 CM / 55.9"

Shipper Colli 5
 Gross Weight (kg) 109.886
 Net Weight (kg) 93.895
 Warranty Period 5 years

Pattern No.	Color	Contract Price	Lead Time
Ready-To-Ship US Warehouse			
MLINSYTC1-WHIT-OAK	White Laminate/White ABS/Oak	USD 4,671.00	-
MLINSYTC1-BLCK-BLCK	Black Nanolaminate/Black ABS/Black	USD 5,875.00	-
MLINSYTC1-BLCK-OAK	Black Nanolaminate/Black ABS/Oak	USD 5,875.00	-
MLINSYTC1-OAK-OAK	Oak Veneer/Oak	USD 5,245.00	-
MLINSYTC1-BASH-BLCK	Black Lacquered Ash Veneer/Black	USD 5,245.00	-

LINEAR SYSTEM CONFIGURATIONS / CONFIGURATION 2 - W: 142 CM / 55.9"

Shipper Colli	5
Gross Weight (kg)	141.512
Net Weight (kg)	122.82
Warranty Period	5 years

Pattern No.	Color	Contract Price	Lead Time
Ready-To-Ship US Warehouse			
MLINSYTC2-WHIT-OAK	White Laminate/White ABS/Oak ***	USD 5,875.00	-
MLINSYTC2-BLCK-BLCK	Black Nanolaminate/Black ABS/Black	USD 7,555.00	-
MLINSYTC2-BLCK-OAK	Black Nanolaminate/Black ABS/Oak	USD 7,555.00	-
MLINSYTC2-OAK-OAK	Oak Veneer/Oak	USD 6,561.00	-
MLINSYTC2-BASH-BLCK	Black Lacquered Ash Veneer/Black	USD 6,561.00	-



720 cm / 283.5"

142 cm / 55.9"



74 cm / 29.1"

146,9 cm / 57.8"

Shipper Colli	8
Gross Weight (kg)	217.812
Net Weight (kg)	188.38
Warranty Period	5 years

Pattern No.	Color	Contract Price	Lead Time
Ready-To-Ship US Warehouse			
MLINSYTC3-WHIT-OAK	White Laminate/White ABS/Oak ***	USD 8,766.00	-
MLINSYTC3-BLCK-BLCK	Black Nanolaminat/Black ABS/Black	USD 11,545.00	-
MLINSYTC3-BLCK-OAK	Black Nanolaminat/Black ABS/Oak	USD 11,545.00	-
MLINSYTC3-OAK-OAK	Oak Veneer/Oak	USD 9,340.00	-
MLINSYTC3-BASH-BLCK	Black Lacquered Ash Veneer/Black	USD 9,340.00	-

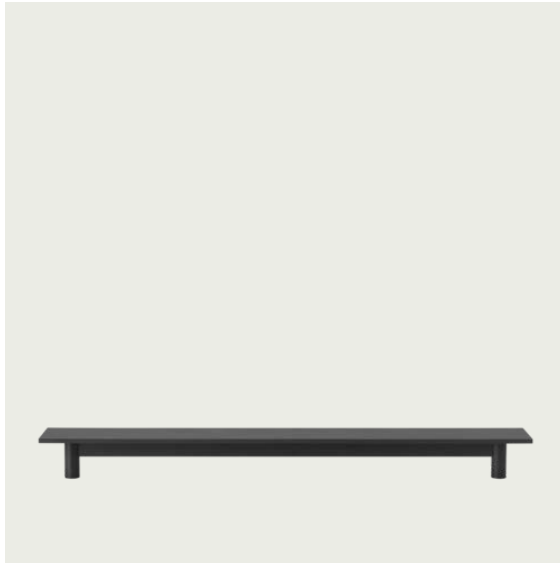

170 cm / 66.9"

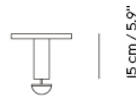

15 cm / 5.9"

21 cm / 8.3"

Shipper Colli	1
Gross Weight (kg)	11.805
Net Weight (kg)	6.7
Warranty Period	5 years

Pattern No.	Color	Contract Price	Lead Time
Ready-To-Ship US Warehouse			
MLINSYTR67-BLCK	Black	USD 450.00	-
MLINSYTR67-OAK	Oak	USD 450.00	-

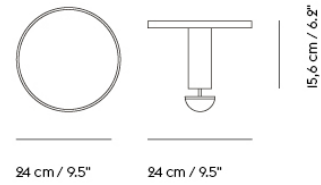

Shipper Colli 1
Gross Weight (kg) 2.805
Net Weight (kg) 0.85
Warranty Period 5 years

Pattern No.	Color	Contract Price	Lead Time
Ready-To-Ship US Warehouse			
MLINSYTT09-BLCK	Black	USD 226.00	-
MLINSYTT09-OAK	Oak	USD 226.00	-

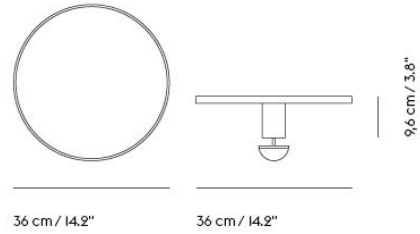

Shipper Colli	1
Gross Weight (kg)	3.603
Net Weight (kg)	1.4
Warranty Period	5 years

Pattern No.	Color	Contract Price	Lead Time
Ready-To-Ship US Warehouse			
MLINSYTT014-BLCK	Black	USD 236.00	-
MLINSYTT014-OAK	Oak	USD 236.00	-

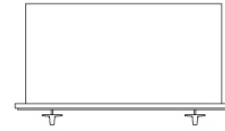
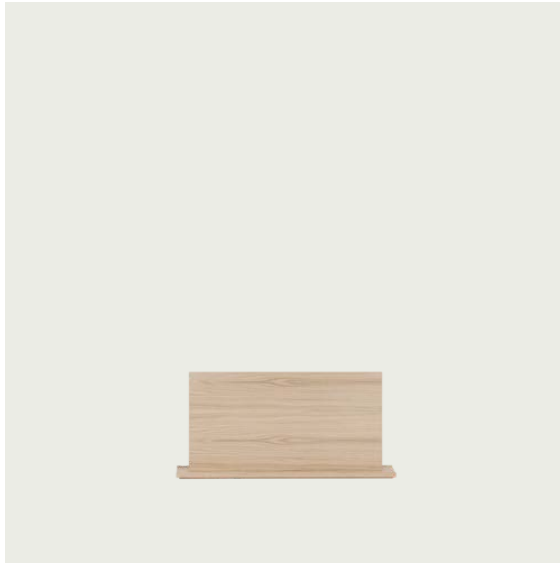

75 cm / 29.5"

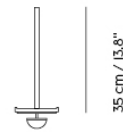

35 cm / 13.8"

15 cm / 5.9"

Shipper Colli	1
Gross Weight (kg)	6.35
Net Weight (kg)	3.9
Additional Information	Colors - Oak or Black
Warranty Period	5 years

Pattern No.	Color	Contract Price	Lead Time
Ready-To-Ship US Warehouse			
MLINSYSW29-BLCK	Black	USD 383.00	-
MLINSYSW29-OAK	Oak	USD 383.00	-



125 cm / 49.2"

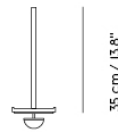

15 cm / 5.9"

Shipper Colli	1
Gross Weight (kg)	9.6
Net Weight (kg)	6.6
Additional Information	Colors - Oak or Black
Warranty Period	5 years

Pattern No.	Color	Contract Price	Lead Time
Ready-To-Ship US Warehouse			
MLINSYSW49-BLCK	Black	USD 520.00	-
MLINSYSW49-OAK	Oak	USD 520.00	-



178 cm / 70.1"

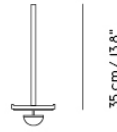

15 cm / 5.9"

Shipper Colli	1
Gross Weight (kg)	13.849
Net Weight (kg)	9.25
Additional Information	Colors - Oak or Black
Warranty Period	5 years

Pattern No.	Color	Contract Price	Lead Time
Ready-To-Ship US Warehouse			
MLINSYSW70-BLCK	Black	USD 681.00	-
MLINSYSW70-OAK	Oak	USD 681.00	-

LINEAR SYSTEM POWER CONFIGURATION



Gross Weight (kg) 0.7
 Please note The connector pins in this product contains lead, CAS no. 7439-92-1
 Warranty Period 5 years

Pattern No.	Color	Contract Price	Lead Time
Ready-To-Ship US Warehouse			
MLINSYPK	Linear System Power Configuration 1	USD 278.00	-
MLINSYPC2	Black - Configuration 2	USD 541.00	-
MLINSYPC3	Black - Configuration 3	USD 807.00	-

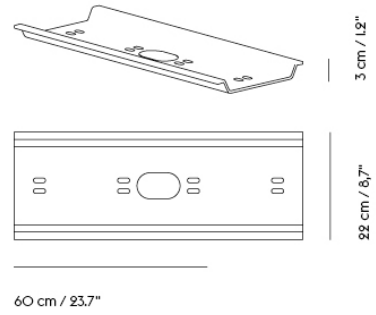

Shipper Colli 1
Gross Weight (kg) 0.212
Net Weight (kg) 0.181
Warranty Period 5 years

Pattern No.	Color	Contract Price	Lead Time
Ready-To-Ship US Warehouse			
MLINSYCT	Dark Grey	USD 135.00	-

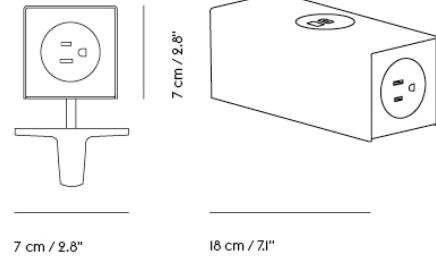

Shipper Colli 1
Gross Weight (kg) 1.5
Net Weight (kg) 1.4
Warranty period 5 years

Pattern No.	Color	Contract Price	Lead Time
Ready-To-Ship US Warehouse			
MLINSYPO-BLCK	Black	USD 667.00	-
MLINSYPO-GREY	Grey	USD 667.00	-

LINEAR SYSTEM SCREEN

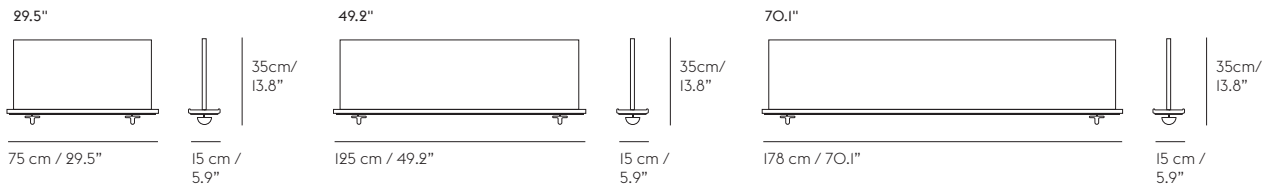

All Variants

Contract Price

All Variants	Pattern No.	Wood Screen	Upholstery Grades			
			A	B	C	E
29.5"	M-LINSYS-W-29	383				
	M-LINSYS-U-29		509	562	614	660
49.2"	M-LINSYS-W-49	520				
	M-LINSYS-U-49		667	734	828	898
70.1"	M-LINSYS-W-70	681				
	M-LINSYS-U-70		933	1,028	1,150	1,206

HOW TO CONFIGURE

Specify:

- Step 1: Choose variant
- Step 2: Choose base color
- Step 3: Choose textile
- Step 4: Choose textile color

ORDER CODE EXAMPLE:

Linear System Screen 49.2" Remix 133

Size	Linear System Screen 49.2"	M-LINSYS-U-49
Textile	Remix M156	
Textile Color	133	133
Final Pattern No:	MLINSYSU49M156133	

Base Finish Options

- BLCK - Anthracite Black
- CHRO - Chrome

Upholstery Options

A	B	C	E
Ocean (M161)*	Canvas (M153)	Hallingdal (M146)	Acca (M12660)
Remix (M156)	Clara (M154)		Beck (M6376)
Wooly (M159)	Fiord (M155)		Divina (M150)
	Hero (M164)		Divina MD (M147)
	Grain (M12659)		Divina Melange (M135)
	Manner (M12665)		Ecriture (M01767)
	Re-Wool (M4586)		Hearth (M12664)
	Sabi (M8404)		Planum (M5904)
	Steelcut (M149)		Twill Weave (M142)
	Steelcut Trio (M139)		Vidar (M158)

*Notes:
Ocean - Color 3, 21, 32, 50, 52, 80 & 601

LINEAR STEEL SERIES

“The Linear Steel Series was designed from the idea of presenting durable materials in a sophisticated and understated expression for outdoor use with its form language inspired by the notion of meetings—the meetings of lines, the meetings of shapes and the meetings of materials. The design is defined by its straight lines for a contemporary yet timeless aesthetic through the details of its folded edges, half-circular intersecting legs and small spacing for easy outflow of water. It is through these subtle elements that the Linear Steel Series translates the values of elegance, longevity and functionality into modern outdoor furniture.”

— Thomas Bentzen



Designed by	Thomas Bentzen
Environment	Outdoor
Country of Production	Table & Bench in Sweden / Table 220 cm, Chairs, Coffee Table & Café Table in Italy / Cover in China / Seat Pad in Vietnam
Assembly Required	Yes - Assembly required for Bench, Table, Coffee Table & Café Table / No - Assembly not required for Chairs
Description	The Linear Steel Series brings new perspectives to modern outdoor furniture through its straight lines alongside the folded edges, half-circular intersecting legs and small spacing for easy removal of water. Kept visually clean for long-lasting aesthetics, the Linear Steel Series finds its distinct character through subtle detailing and a simple expression, allowing for it to complement any outdoor setting.
Material	<p>Armchair, Side Chair, Lounge chair: Made from galvanized steel with a weather-resistant deep matt, UV-resistant powder-coated finish, making the chair suitable for outdoor use. Plastic glides for outdoor use.</p> <p>Café Table & Coffee Table: The tabletop and base are made from galvanized steel with a weather-resistant deep matt, UV-resistant powder-coated finish, making the table suitable for outdoor use. Plastic glides for outdoor use.</p> <p>Table 140 cm, 200 cm, 220 cm: Frame and top are made from welded steel with a weather-resistant deep matt powder coated finish. The top is hot-dip galvanized while legs are aluzinc treated, making them suitable for outdoor use. Legs come with plastic glides.</p> <p>Cover for 200 cm and 140 cm Tables in PVC coated Polyester. Cover for 220 cm table in Polyester with TPU membrane.</p> <p>Seat Pads in upholstered foam with black, anti-slip backing. Upholstered in UV-protected polyester textile. Rope for attachment.</p>

Cleaning & Care

Linear Steel Side Chair, Armchair, Bar Stool & Counter Stool stacks up to 5 chairs on the floor. Linear Steel Lounge Chair stacks up to 4 chairs on the floor.

When cared for properly, the Linear Steel Series is designed to last. Follow these simple rules to care for your design in the best possible way.

Clean the table with a damp cloth after use. If necessary, use a mild detergent or dish-washing liquid, not concentrated. Always wipe with a dry cloth afterward. To minimize the risk of stains and marks, liquids, grease, etc., should be removed immediately. Lacquered surfaces can get scratches and chips if hit by other hard objects. Please wipe away any sand grains from the table before use to prevent scratches. Be careful around the design when handling other hard objects, such as tableware and porcelain. Never stack tables on top of each other, as hitting the surfaces against each other will cause lacquer to chip and scratch.

In case of minor scratches in the paint, Muuto recommends that you contact your local hardware store to get advice on which outdoor paint products to use, to cover the minor scratches.

Cover: Clean with a damp cloth. If necessary, use a mild detergent or dish-washing liquid, not concentrated. Please make sure that both the piece of furniture and the inside of the cover is completely dry before putting the cover on.

Seat pads are water-repellent, and the textile is breathable. However, we recommend taking them inside during rainy weather to ensure a long lifetime of the product. Remove non-greasy stains by carefully dabbing with a lint-free cloth wrung out in clean, warm water. If necessary, clean by dabbing with soapy water.

Color Codes:

Burnt orange: RAL 8001
 Dark Green: RAL 6012
 Anthracite Black: RAL 7021
 Grey: RAL 7044
 Pale Blue: NCS 4020-B

TESTS & CERTIFICATIONS*

ANSI/BIFMA X5.5-2014

Linear Steel Table, Café Tables & Coffee Tables:
 American National Standard for Office Furnishings-Desk Products.

EN 581-1:2017

Outdoor Furniture-General safety for domestic and contract.

EN 581-3:2017

Outdoor Furniture-Mechanical safety for domestic and contract tables.

EN 15372:2016 - L3

Severe Use
 Strength, durability and safety - Requirements for non-domestic tables

EN 1022:2005

Linear Steel Bench and Linear Steel Side Chair:
 Domestic Seating - Determination of stability

EN 16139:2013 - LI

Linear Steel Side Chair:
 General use. Furniture - Strength, durability and safety
 Requirements for non-domestic seating.

EN 16139:2013 - L2

Linear Steel Bench & Lounge Chair:
 General use. Furniture - Strength, durability and safety
 Requirements for non-domestic seating.

ANSI/BIFMA X5.4-2012

American National Standard for Office
 Furnishings - Lounge and Public Seating

EN 581-1:2017

Linear Steel Bar Stool, Counter Stool & Lounge Chair:
 Outdoor Furniture-General safety for domestic and contract.

*Please note that none of the above mentioned test and certifications apply to the Linear Steel Armchair.

LINEAR STEEL TABLE / 140 X 75 CM / 55.1 X 29.5"

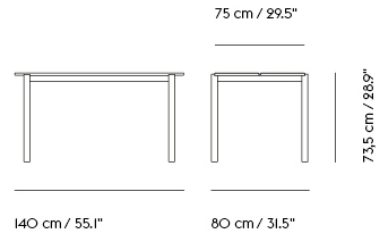

Shipper Colli	3
Gross Weight (kg)	46.25
Net Weight (kg)	40
Warranty Period	10 years

Pattern No.	Color	Contract Price	Lead Time
Ready-To-Ship US Warehouse			
MLINST5530-BLCK	Anthracite Black	USD 1,675.00	-
MLINST5530-BORG	Burnt Orange	USD 1,675.00	-
MLINST5530-DKGN	Dark Green	USD 1,675.00	-
MLINST5530-GREY	Grey	USD 1,675.00	-
MLINST5530-PABU	Pale Blue	USD 1,675.00	-
Extras			
MLINSG	Plastic glides for Linear Steel Table and Bench - Black	USD 21.00	-
MLINSS	Adjustable Feet for Linear Steel Table & Bench	USD 34.00	-
MLINSM	Linear Steel Ground Mounting Kit	USD 142.00	-
MLINSC5530	Outdoor Cover for Linear Steel Table 140 x 75 CM / 55.1 x 29.5	USD 167.00	-

LINEAR STEEL TABLE / 200 X 75 CM / 78.7 X 29.5"

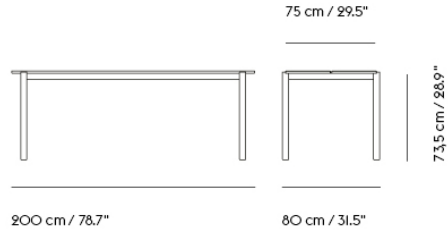

Shipper Colli 3
 Gross Weight (kg) 58.35
 Net Weight (kg) 51
 Warranty Period 10 years

Pattern No.	Color	Contract Price	Lead Time
Ready-To-Ship US Warehouse			
MLINST7930-BLCK	Anthracite Black	USD 1,885.00	-
MLINST7930-BORG	Burnt Orange	USD 1,885.00	-
MLINST7930-DKGN	Dark Green	USD 1,885.00	-
MLINST7930-GREY	Grey	USD 1,885.00	-
MLINST7930-WHIT	Off-White ***	USD 1,885.00	-
MLINST7930-PABU	Pale Blue	USD 1,885.00	-
Extras			
MLINSG	Plastic glides for Linear Steel Table and Bench - Black	USD 21.00	-
MLINSS	Adjustable Feet for Linear Steel Table & Bench	USD 34.00	-
MLINSM	Linear Steel Ground Mounting Kit	USD 142.00	-
MLINSC7930	Linear Steel Cover - Black - 200 x 75cm / 78.7 x 29.5"	USD 184.00	-

LINEAR STEEL TABLE / 220 X 90 CM / 86.6 X 35.5"

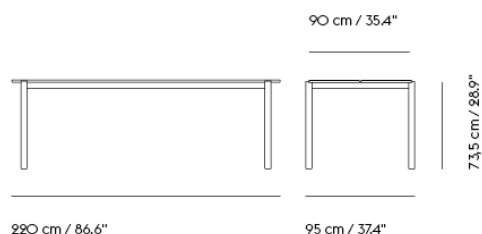

Shipper Colli	3
Gross Weight (kg)	73.1
Net Weight (kg)	62
Warranty Period	10 years

Pattern No.	Color	Contract Price	Lead Time
Ready-To-Ship US Warehouse			
MLINST8635-BLCK	Anthracite Black	USD 2,256.00	-
MLINST8635-BORG	Burnt Orange	USD 2,256.00	-
MLINST8635-DKGN	Dark Green	USD 2,256.00	-
MLINST8635-GREY	Grey	USD 2,256.00	-
MLINST8635-PABU	Pale Blue	USD 2,256.00	-
Extras			
MLINSG	Plastic glides for Linear Steel Table and Bench - Black	USD 21.00	-
MLINSS	Adjustable Feet for Linear Steel Table & Bench	USD 34.00	-
MLINSM	Linear Steel Ground Mounting Kit	USD 142.00	-
MODCV-BLCK	Outdoor Cover for 70/70 Outdoor Table and Linear Steel Table 220 x 90 CM / 86.6 x 35.5	USD 299.00	-

LINEAR STEEL BENCH / 110 X 34 CM / 43.3 X 15.4"

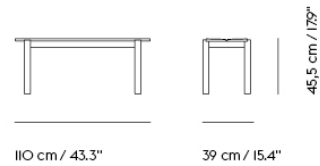

Shipper Colli	2
Gross Weight (kg)	30.132
Net Weight (kg)	22
Warranty Period	10 years

Pattern No.	Color	Contract Price	Lead Time
Ready-To-Ship US Warehouse			
MLINSB43-BLCK	Anthracite Black	USD 877.00	-
MLINSB43-BORG	Burnt Orange	USD 877.00	-
MLINSB43-DKGN	Dark Green	USD 877.00	-
MLINSB43-GREY	Grey	USD 877.00	-
MLINSB43-WHIT	Off-White ***	USD 877.00	-
MLINSB43-PABU	Pale Blue	USD 877.00	-
Extras			
MLINSG	Plastic glides for Linear Steel Table and Bench - Black	USD 21.00	-
MLINSS	Adjustable Feet for Linear Steel Table & Bench	USD 34.00	-
MLINSM	Linear Steel Ground Mounting Kit	USD 142.00	-
MLINSB43PD-DKGY	Bench Seat Pad - Twitell - Dark Grey	USD 198.00	-
MLINSB43PD-LTGY	Bench Seat Pad - Twitell - Light Grey	USD 198.00	-

LINEAR STEEL BENCH / 170 X 34 CM / 66.9 X 15.4"

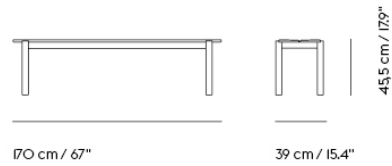

Shipper Colli 2
Gross Weight (kg) 27
Net Weight (kg) 25
Warranty Period 10 years

Pattern No.	Color	Contract Price	Lead Time
Ready-To-Ship US Warehouse			
MLINSB67-BLCK	Anthracite Black	USD 1,206.00	-
MLINSB67-BORG	Burnt Orange	USD 1,206.00	-
MLINSB67-DKGN	Dark Green	USD 1,206.00	-
MLINSB67-GREY	Grey	USD 1,206.00	-
MLINSB67-WHIT	Off-White ***	USD 1,206.00	-
MLINSB67-PABU	Pale Blue	USD 1,206.00	-
Extras			
MLINSG	Plastic glides for Linear Steel Table and Bench - Black	USD 21.00	-
MLINSS	Adjustable Feet for Linear Steel Table & Bench	USD 34.00	-
MLINSM	Linear Steel Ground Mounting Kit	USD 142.00	-
MLINSB67PD-DKGY	Bench Seat Pad - Twitell - Dark Grey	USD 272.00	-
MLINSB67PD-LTGY	Bench Seat Pad - Twitell - Light Grey	USD 272.00	-

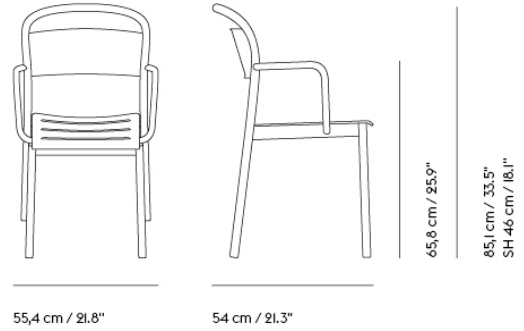

Shipper Colli	1
Gross Weight (kg)	12.4
Net Weight (kg)	8.2
Stacking Information	Linear Steel Armchair stacks up to 5 chairs on the floor.
Warranty Period	5 years

Pattern No.	Color	Contract Price	Lead Time
Ready-To-Ship US Warehouse			
MLINSCHA-BLCK	Anthracite Black	USD 488.00	-
MLINSCHA-BORG	Burnt Orange	USD 488.00	-
MLINSCHA-DKGN	Dark Green	USD 488.00	-
MLINSCHA-GREY	Grey	USD 488.00	-
MLINSCHA-OWHIT	Off-White ***	USD 488.00	-
MLINSCHA-PABU	Pale Blue	USD 488.00	-
Extras			
MLINSCHRPD-DKGY	Chair Seat Pad - Twitell - Dark Grey	USD 100.00	-
MLINSCHRPD-LTGY	Chair Seat Pad - Twitell - Light Grey	USD 100.00	-

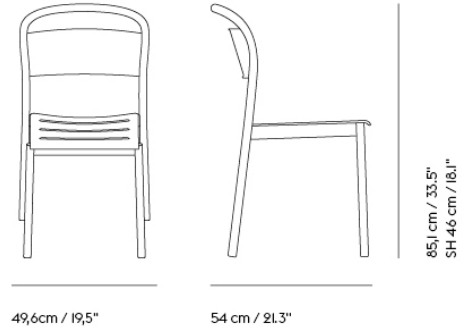

Shipper Colli	1
Gross Weight (kg)	11.45
Net Weight (kg)	8.05
Stacking Information	Linear Steel Side Chair stacks up to 5 chairs on the floor.
Warranty Period	5 years

Pattern No.	Color	Contract Price	Lead Time
Ready-To-Ship US Warehouse			
MLINSCHS-BLCK	Anthracite Black	USD 450.00	-
MLINSCHS-BORG	Burnt Orange	USD 450.00	-
MLINSCHS-DKGN	Dark Green	USD 450.00	-
MLINSCHS-GREY	Grey	USD 450.00	-
MLINSCHS-OWHIT	Off-White ***	USD 450.00	-
MLINSCHS-PABU	Pale Blue	USD 450.00	-
Extras			
MLINSCHRPD-DKGY	Chair Seat Pad - Twitell - Dark Grey	USD 100.00	-
MLINSCHRPD-LTGY	Chair Seat Pad - Twitell - Light Grey	USD 100.00	-

LINEAR STEEL CAFÉ TABLE / 70 X 70 H: 73 CM / 27.6 X 27.6 H: 28.7"

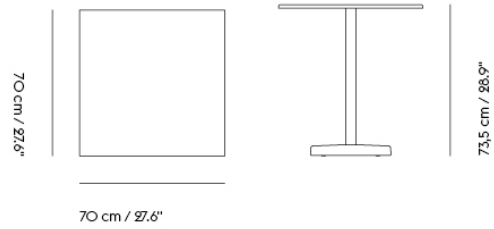

Shipper Colli	3
Gross Weight (kg)	28.704
Net Weight (kg)	26.2
Warranty Period	10 years

Pattern No.	Color	Contract Price	Lead Time
Ready-To-Ship US Warehouse			
MLINSCTR272728-BLCK	Anthracite Black	USD 933.00	-
MLINSCTR272728-BORG	Burnt Orange	USD 933.00	-
MLINSCTR272728-DKGN	Dark Green	USD 933.00	-
MLINSCTR272728-GREY	Grey	USD 933.00	-
MLINSCTR272728-PABU	Pale Blue	USD 933.00	-

**LINEAR STEEL CAFÉ TABLE / 70 X 70 H:
95 CM / 27.6 X 27.6 H: 37.4"**

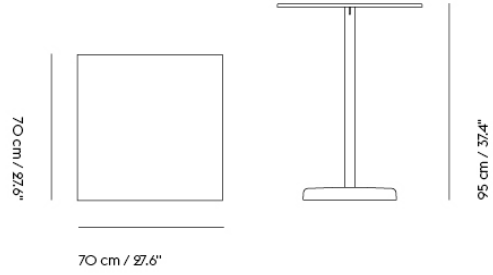

Shipper Colli 3
 Gross Weight (kg) 29.704
 Net Weight (kg) 27
 Warranty Period 10 years

Pattern No.	Color	Contract Price	Lead Time
Ready-To-Ship US Warehouse			
MLINSCTR272737-BLCK	Anthracite Black	USD 971.00	-
MLINSCTR272737-BORG	Burnt Orange	USD 971.00	-
MLINSCTR272737-DKGN	Dark Green	USD 971.00	-
MLINSCTR272737-GREY	Grey	USD 971.00	-
MLINSCTR272737-PABU	Pale Blue	USD 971.00	-

LINEAR STEEL CAFÉ TABLE / 70 X 70 H: 105 CM / 27.6 X 27.6 H: 41.3"

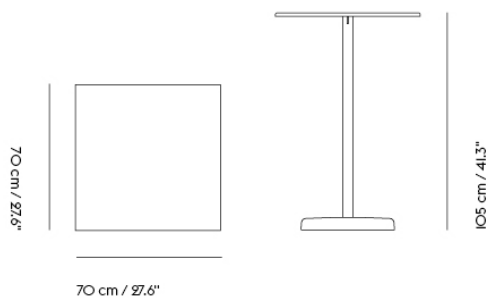

Shipper Colli	3
Gross Weight (kg)	30.104
Net Weight (kg)	27.3
Warranty Period	10 years

Pattern No.	Color	Contract Price	Lead Time
Ready-To-Ship US Warehouse			
MLINSCTR272741-BLCK	Anthracite Black	USD 971.00	-
MLINSCTR272741-BORG	Burnt Orange	USD 971.00	-
MLINSCTR272741-DKGN	Dark Green	USD 971.00	-
MLINSCTR272741-GREY	Grey	USD 971.00	-
MLINSCTR272741-PABU	Pale Blue	USD 971.00	-

LINEAR STEEL CAFÉ TABLE / Ø 70 H: 73 CM / 27.6 H: 28.7"

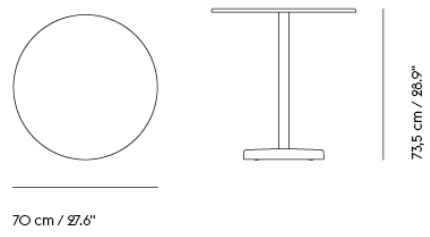

Shipper Colli 3
Gross Weight (kg) 26.704
Net Weight (kg) 24.2
Warranty Period 10 years

Pattern No.	Color	Contract Price	Lead Time
Ready-To-Ship US Warehouse			
MLINSCTO2728-BLCK	Anthracite Black	USD 933.00	-
MLINSCTO2728-BORG	Burnt Orange	USD 933.00	-
MLINSCTO2728-DKGN	Dark Green	USD 933.00	-
MLINSCTO2728-GREY	Grey	USD 933.00	-
MLINSCTO2728-PABU	Pale Blue	USD 933.00	-

**LINEAR STEEL CAFÉ TABLE / Ø 70 H: 95
CM / 27.6 H: 37.4"**

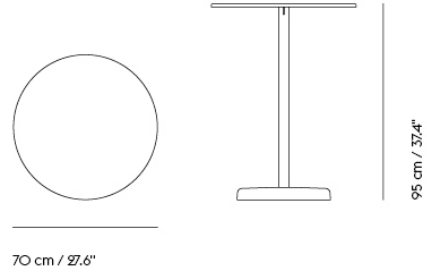

Shipper Colli 3
 Gross Weight (kg) 27.704
 Net Weight (kg) 25
 Warranty Period 10 years

Pattern No.	Color	Contract Price	Lead Time
Ready-To-Ship US Warehouse			
MLINSCTO2737-BLCK	Anthracite Black	USD 971.00	-
MLINSCTO2737-BORG	Burnt Orange	USD 971.00	-
MLINSCTO2737-DKGN	Dark Green	USD 971.00	-
MLINSCTO2737-GREY	Grey	USD 971.00	-
MLINSCTO2737-PABU	Pale Blue	USD 971.00	-

**LINEAR STEEL CAFÉ TABLE / Ø 70 H: 105
CM / 27.6 H: 41.3"**

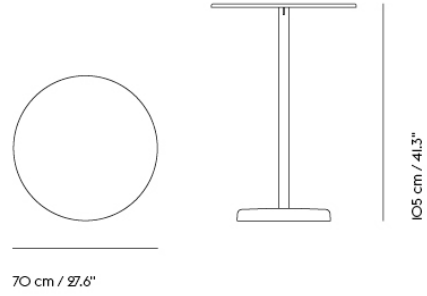

Shipper Colli 3
 Gross Weight (kg) 28.104
 Net Weight (kg) 25.3
 Warranty Period 10 years

Pattern No.	Color	Contract Price	Lead Time
Ready-To-Ship US Warehouse			
MLINSCTO2741-BLCK	Anthracite Black	USD 971.00	-
MLINSCTO2741-BORG	Burnt Orange	USD 971.00	-
MLINSCTO2741-DKGN	Dark Green	USD 971.00	-
MLINSCTO2741-GREY	Grey	USD 971.00	-
MLINSCTO2741-PABU	Pale Blue	USD 971.00	-

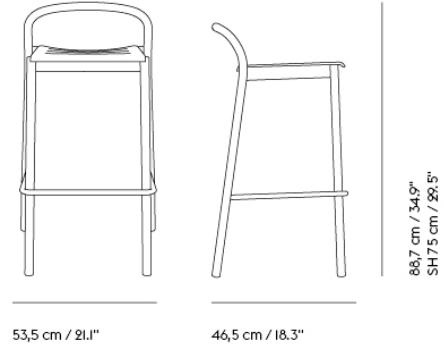

Shipper Colli	1
Gross Weight (kg)	12.7
Net Weight (kg)	9.5
Stacking Information	Linear Steel Bar Stool stacks up to 5 stools on the floor.
Warranty period	5 years

Pattern No.	Color	Contract Price	Lead Time
Ready-To-Ship US Warehouse			
MLINSSTB-BLCK	Anthracite Black	USD 530.00	-
MLINSSTB-BORG	Burnt Orange	USD 530.00	-
MLINSSTB-DKGN	Dark Green	USD 530.00	-
MLINSSTB-GREY	Grey	USD 530.00	-
MLINSSTB-PABU	Pale Blue	USD 530.00	-
Extras			
MLINSSTPD-DKGY	Bar/Counter Seat Pad - Twitell - Dark Grey	USD 89.00	-
MLINSSTPD-LTGY	Bar/Counter Seat Pad - Twitell - Light Grey	USD 89.00	-

LINEAR STEEL COUNTER STOOL 65 CM / 25.6"

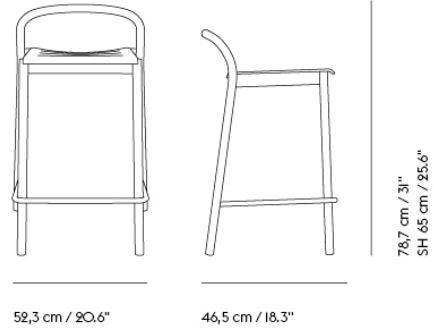

Shipper Colli	1
Gross Weight (kg)	12.1
Net Weight (kg)	8.9
Stacking Information	Linear Steel Counter Stool stacks up to 5 stools on the floor.
Warranty period	5 years

Pattern No.	Color	Contract Price	Lead Time
Ready-To-Ship US Warehouse			
MLINSSTC-BLCK	Anthracite Black	USD 530.00	-
MLINSSTC-BORG	Burnt Orange	USD 530.00	-
MLINSSTC-DKGN	Dark Green	USD 530.00	-
MLINSSTC-GREY	Grey	USD 530.00	-
MLINSSTC-PABU	Pale Blue	USD 530.00	-
Extras			
MLINSSTPD-DKGY	Bar/Counter Seat Pad - Twitell - Dark Grey	USD 89.00	-
MLINSSTPD-LTGY	Bar/Counter Seat Pad - Twitell - Light Grey	USD 89.00	-

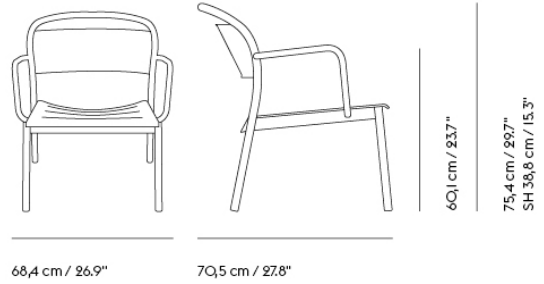

Shipper Colli	1
Gross Weight (kg)	16.35
Net Weight (kg)	13.2
Stacking Information	Linear Steel Lounge Chair stacks up to 4 chairs on the floor.
Warranty Period	10 years

Pattern No.	Color	Contract Price	Lead Time
Ready-To-Ship US Warehouse			
MLINSLC-BLCK	Anthracite Black	USD 929.00	-
MLINSLC-BORG	Burnt Orange	USD 929.00	-
MLINSLC-DKGN	Dark Green	USD 929.00	-
MLINSLC-GREY	Grey	USD 929.00	-
MLINSLC-PABU	Pale Blue	USD 929.00	-
Extras			
MLINSLCPD-DKGY	Lounge Chair Seat Pad - Twitell - Dark Grey	USD 121.00	-
MLINSLCPD-LTGY	Lounge Chair Seat Pad - Twitell - Light Grey	USD 121.00	-

LINEAR STEEL COFFEE TABLE / Ø 42 H: 47 CM / 16.5 H: 18.5"

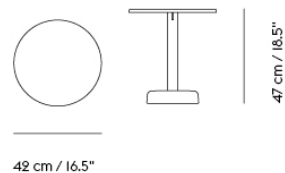

Shipper Colli 3
Net Weight (kg) 7.4
Warranty period 10 years

Pattern No.	Color	Contract Price	Lead Time
Ready-To-Ship US Warehouse			
MLINSCFT01719-BLCK	Anthracite Black	USD 660.00	-
MLINSCFT01719-BORG	Burnt Orange	USD 660.00	-
MLINSCFT01719-DKGN	Dark Green	USD 660.00	-
MLINSCFT01719-GREY	Grey	USD 660.00	-
MLINSCFT01719-PABU	Pale Blue	USD 660.00	-

LINEAR STEEL COFFEE TABLE / Ø 70 H: 40 CM / 27.5 H: 15.5"

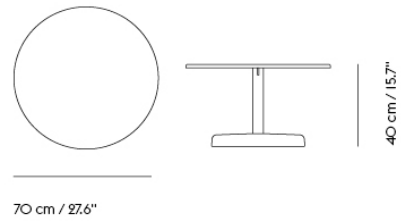

Shipper Colli 3
 Net Weight (kg) 23
 Warranty period 10 years

Pattern No.	Color	Contract Price	Lead Time
Ready-To-Ship US Warehouse			
MLINSCFT02716-BLCK	Anthracite Black	USD 797.00	-
MLINSCFT02716-BORG	Burnt Orange	USD 797.00	-
MLINSCFT02716-DKGN	Dark Green	USD 797.00	-
MLINSCFT02716-GREY	Grey	USD 797.00	-
MLINSCFT02716-PABU	Pale Blue	USD 797.00	-

LINEAR STEEL SERIES

“The Linear Steel Series was designed from the idea of presenting durable materials in a sophisticated and understated expression for outdoor use with its form language inspired by the notion of meetings—the meetings of lines, the meetings of shapes and the meetings of materials. The design is defined by its straight lines for a contemporary yet timeless aesthetic through the details of its folded edges, half-circular intersecting legs and small spacing for easy outflow of water. It is through these subtle elements that the Linear Steel Series translates the values of elegance, longevity and functionality into modern outdoor furniture.”

— Thomas Bentzen



Designed by	Thomas Bentzen
Environment	Outdoor
Country of Production	Table & Bench in Sweden / Table 220 cm, Chairs, Coffee Table & Café Table in Italy / Cover in China / Seat Pad in Vietnam
Assembly Required	Yes - Assembly required for Bench, Table, Coffee Table & Café Table / No - Assembly not required for Chairs
Description	The Linear Steel Series brings new perspectives to modern outdoor furniture through its straight lines alongside the folded edges, half-circular intersecting legs and small spacing for easy removal of water. Kept visually clean for long-lasting aesthetics, the Linear Steel Series finds its distinct character through subtle detailing and a simple expression, allowing for it to complement any outdoor setting.
Material	<p>Armchair, Side Chair, Lounge chair: Made from galvanized steel with a weather-resistant deep matt, UV-resistant powder-coated finish, making the chair suitable for outdoor use. Plastic glides for outdoor use.</p> <p>Café Table & Coffee Table: The tabletop and base are made from galvanized steel with a weather-resistant deep matt, UV-resistant powder-coated finish, making the table suitable for outdoor use. Plastic glides for outdoor use.</p> <p>Table 140 cm, 200 cm, 220 cm: Frame and top are made from welded steel with a weather-resistant deep matt powder coated finish. The top is hot-dip galvanized while legs are aluzinc treated, making them suitable for outdoor use. Legs come with plastic glides.</p> <p>Cover for 200 cm and 140 cm Tables in PVC coated Polyester. Cover for 220 cm table in Polyester with TPU membrane.</p> <p>Seat Pads in upholstered foam with black, anti-slip backing. Upholstered in UV-protected polyester textile. Rope for attachment.</p>

Cleaning & Care

Linear Steel Side Chair, Armchair, Bar Stool & Counter Stool stacks up to 5 chairs on the floor. Linear Steel Lounge Chair stacks up to 4 chairs on the floor.

When cared for properly, the Linear Steel Series is designed to last. Follow these simple rules to care for your design in the best possible way.

Clean the table with a damp cloth after use. If necessary, use a mild detergent or dish-washing liquid, not concentrated. Always wipe with a dry cloth afterward. To minimize the risk of stains and marks, liquids, grease, etc., should be removed immediately. Lacquered surfaces can get scratches and chips if hit by other hard objects. Please wipe away any sand grains from the table before use to prevent scratches. Be careful around the design when handling other hard objects, such as tableware and porcelain. Never stack tables on top of each other, as hitting the surfaces against each other will cause lacquer to chip and scratch.

In case of minor scratches in the paint, Muuto recommends that you contact your local hardware store to get advice on which outdoor paint products to use, to cover the minor scratches.

Cover: Clean with a damp cloth. If necessary, use a mild detergent or dish-washing liquid, not concentrated. Please make sure that both the piece of furniture and the inside of the cover is completely dry before putting the cover on.

Seat pads are water-repellent, and the textile is breathable. However, we recommend taking them inside during rainy weather to ensure a long lifetime of the product. Remove non-greasy stains by carefully dabbing with a lint-free cloth wrung out in clean, warm water. If necessary, clean by dabbing with soapy water.

Color Codes:

Burnt orange: RAL 8001
 Dark Green: RAL 6012
 Anthracite Black: RAL 7021
 Grey: RAL 7044
 Pale Blue: NCS 4020-B

TESTS & CERTIFICATIONS*

ANSI/BIFMA X5.5-2014

Linear Steel Table, Café Tables & Coffee Tables:
 American National Standard for Office Furnishings-Desk Products.

EN 581-1:2017

Outdoor Furniture-General safety for domestic and contract.

EN 581-3:2017

Outdoor Furniture-Mechanical safety for domestic and contract tables.

EN 15372:2016 - L3

Severe Use
 Strength, durability and safety - Requirements for non-domestic tables

EN 1022:2005

Linear Steel Bench and Linear Steel Side Chair:
 Domestic Seating - Determination of stability

EN 16139:2013 - LI

Linear Steel Side Chair:
 General use. Furniture - Strength, durability and safety
 Requirements for non-domestic seating.

EN 16139:2013 - L2

Linear Steel Bench & Lounge Chair:
 General use. Furniture - Strength, durability and safety
 Requirements for non-domestic seating.

ANSI/BIFMA X5.4-2012

American National Standard for Office
 Furnishings - Lounge and Public Seating

EN 581-1:2017

Linear Steel Bar Stool, Counter Stool & Lounge Chair:
 Outdoor Furniture-General safety for domestic and contract.

*Please note that none of the above mentioned test and certifications apply to the Linear Steel Armchair.

LINEAR STEEL CHAIR/LOUNGE CHAIR SEAT PAD

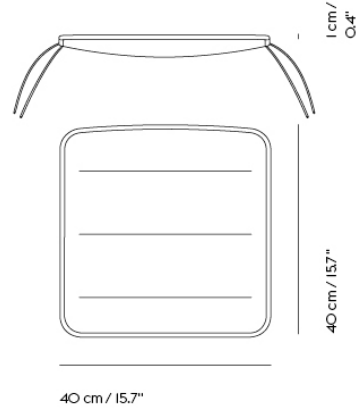
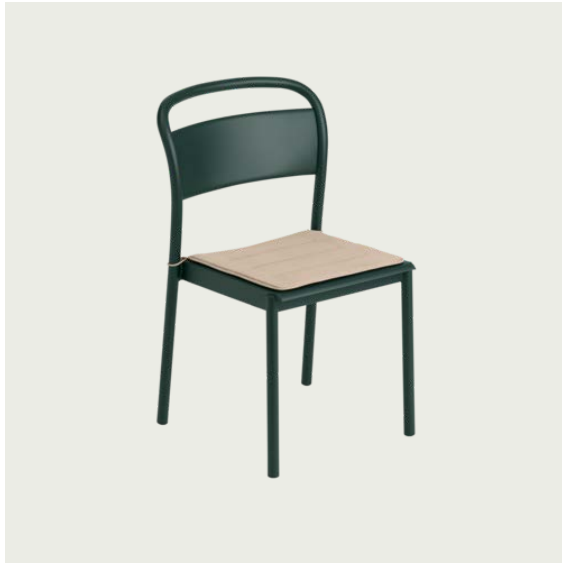

Shipper Colli 1
Gross Weight (kg) 0.19
Net Weight (kg) 0.13
Warranty Period 5 years

Pattern No.	Color	Contract Price	Lead Time
Ready-To-Ship US Warehouse			
MLINSSTPD-DKGY	Bar/Counter Seat Pad - Twitell - Dark Grey	USD 89.00	-
MLINSSTPD-LTGY	Bar/Counter Seat Pad - Twitell - Light Grey	USD 89.00	-
MLINSCHRPD-DKGY	Chair Seat Pad - Twitell - Dark Grey	USD 100.00	-
MLINSCHRPD-LTGY	Chair Seat Pad - Twitell - Light Grey	USD 100.00	-
MLINSLCPD-DKGY	Lounge Chair Seat Pad - Twitell - Dark Grey	USD 121.00	-
MLINSLCPD-LTGY	Lounge Chair Seat Pad - Twitell - Light Grey	USD 121.00	-

LINEAR STEEL BENCH / SEAT PAD / 110 CM / 43.3"

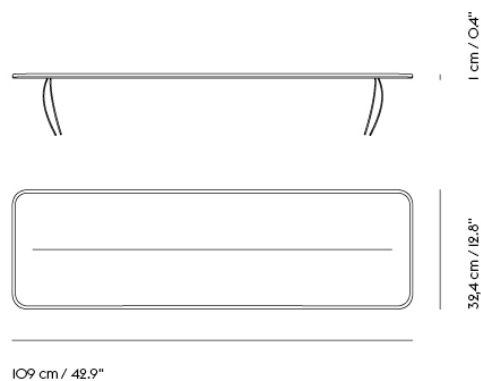

Shipper Colli	1
Gross Weight (kg)	0.97
Net Weight (kg)	0.37
Warranty Period	5 years

Pattern No.	Color	Contract Price	Lead Time
Ready-To-Ship US Warehouse			
MLINSBSP43-BLCK	Patch - Black	USD 163.00	-
MLINSBSP43-GREY	Patch - Grey	USD 163.00	-
MLINSBSP43-WBEG	Patch - Warm Beige	USD 163.00	-
MLINSB43PD-DKGY	Bench Seat Pad - Twitell - Dark Grey	USD 198.00	-
MLINSB43PD-LTGY	Bench Seat Pad - Twitell - Light Grey	USD 198.00	-

LINEAR STEEL BENCH / SEAT PAD / 170 CM / 5'6"

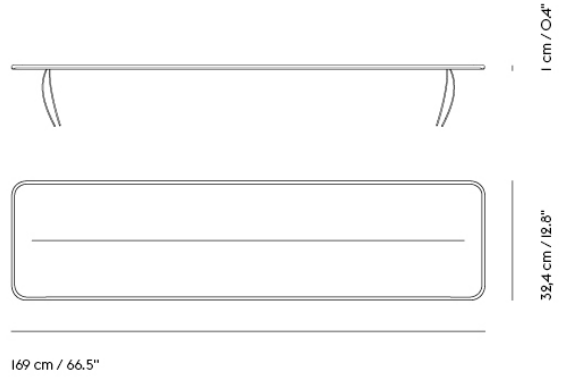

Shipper Colli 1
Gross Weight (kg) 1.48
Net Weight (kg) 0.58
Warranty Period 5 years

Pattern No.	Color	Contract Price	Lead Time
Ready-To-Ship US Warehouse			
MLINSBSP67-BLCK	Patch - Black	USD 226.00	-
MLINSBSP67-GREY	Patch - Grey	USD 226.00	-
MLINSBSP67-WBEG	Patch - Warm Beige	USD 226.00	-
MLINSB67PD-DKGY	Bench Seat Pad - Twitell - Dark Grey	USD 272.00	-
MLINSB67PD-LTGY	Bench Seat Pad - Twitell - Light Grey	USD 272.00	-

LINEAR WOOD SERIES

"The Linear Wood Series was designed from the idea of bringing the warm and friendly sentiment of wood into a timeless, understated shape with its form language inspired by the notion of meetings—the meetings of lines and shapes. The design is defined by its straight lines for a contemporary yet honest aesthetic through the details of its thinly elegant overhang and half-circular intersecting legs. It is through these subtle elements that the Linear Wood Series translates the values of elegance, longevity and functionality into modern Scandinavian design."

— Thomas Bentzen



Designed by	Thomas Bentzen
Environment	Indoor
Country of Production	Latvia
Assembly Required	Yes
Description	The Linear Wood Series brings a simple and elegant perspective to wooden furniture through its modern form language with understated details for a long-lasting expression. Kept visually clean for long-lasting aesthetics, the Linear Wood Series finds its distinct character through subtle detailing and a simple expression.
Material	Top in lacquered oak veneer with veneered plywood aprons and lacquered solid oak legs.
Cleaning & Care	Clean with a damp cloth. If necessary, only use a mild detergent or washing up liquid and not concentrated. Always wipe with a dry cloth afterwards. To minimize the risk of stains and marks, liquid, grease etc. should be removed straight away.

TESTS & CERTIFICATIONS

EN 15372:2008 - L3	Linear Wood Table: Extreme use. Furniture – Strength, durability and safety. Requirements for non-domestic tables.
EN 16139:2013 - L2	Linear Wood Bench: Extreme use. Furniture - Strength, durability and safety. Requirements for non-domestic seating.
EN 1022:2005	Domestic Seating - Determination of stability
ANSI/BIFMA X5.4-2012	American National Standard for Office Furnishings. Lounge and public seating.
VOC CDPH 01350 & VOC BIFMA X7.1.	Linear Wood Series is VOC CDPH 01350 and VOC BIFMA X7.1. tested.

LINEAR WOOD TABLE / 140 X 85 CM / 55.1 X 31.5"

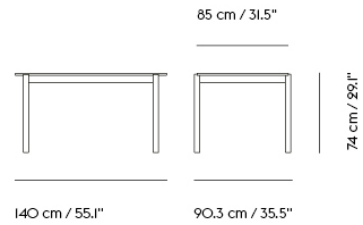

Shipper Colli 1
Gross Weight (kg) 25.5
Net Weight (kg) 18.494
Warranty Period 5 years

Pattern No.	Color	Contract Price	Lead Time
Ready-To-Ship US Warehouse			
MLINWT5532	Oak Veneer/Oak	USD 1,675.00	-
Extras			
70703	70703	USD 23.00	-

LINEAR WOOD TABLE / 200 X 90 CM / 78.7 X 35.4"

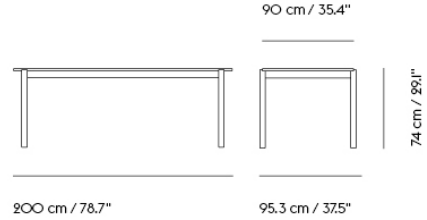

Shipper Colli	1
Gross Weight (kg)	36.6
Net Weight (kg)	28.664
Warranty Period	5 years

Pattern No.	Color	Contract Price	Lead Time
Ready-To-Ship US Warehouse			
MLINWT7933	Oak Veneer/Oak	USD 2,361.00	-
Extras			
70703	70703	USD 23.00	-

LINEAR WOOD TABLE / 260 X 90 CM / 102.4 X 35.4"

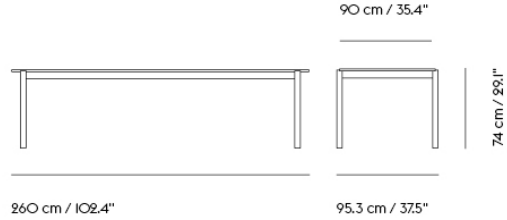

Shipper Colli 1
Gross Weight (kg) 43.6
Net Weight (kg) 34.714
Warranty Period 5 years

Pattern No.	Color	Contract Price	Lead Time
Ready-To-Ship US Warehouse			
MLINWT10336	Oak Veneer/Oak	USD 2,571.00	-
Extras			
70703	70703	USD 23.00	-

LINEAR WOOD BENCH / 110 X 34 CM / 43.3 X 13.4"

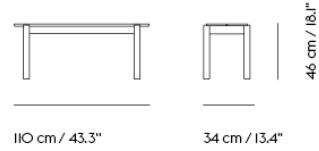

Shipper Colli 1
 Gross Weight (kg) 12
 Net Weight (kg) 7.034
 Warranty Period 10 years

Pattern No.	Color	Contract Price	Lead Time
Ready-To-Ship US Warehouse			
MLINWB43	Oak	USD 902.00	-
Extras			
70703	70703	USD 23.00	-

LINEAR WOOD BENCH / 170 X 34 CM / 67 X 13.4"



170 cm / 66.9"



34 cm / 13.4"

46 cm / 18.1"

Shipper Colli 1
 Gross Weight (kg) 18.4
 Net Weight (kg) 12.894
 Warranty Period 10 years

Pattern No.	Color	Contract Price	Lead Time
Ready-To-Ship US Warehouse			
MLINWB67	Oak	USD 1,150.00	-
Extras			
70703	70703	USD 23.00	-

LOFT CHAIR SERIES

“The Loft Chair Series combines the complementing opposites of robustness and elegance through materials—its wooden seat and metal frame—with a soft, industrial appeal. The design features an archetypical look for a feeling of familiarity while the subtle details, such as its sturdy back legs, gives it a unique expression. The design fits seamlessly into any spatial context while providing maximum comfort to its user.”

— Thomas Bentzen



Designed by	Thomas Bentzen
Environment	Indoor
Country of Production	Latvia
Assembly Required	No
Description	Loft Chair Series exemplifies honest, simple design thanks to an expression inspired by industrial design. The design features contrasting materials with its frame in powder coated steel that is offset by the soft plywood on seat and back, molded to embrace the user's body.
Material	<p>The seat and back are constructed with beech veneer layers and outer oak surface veneers with water-based lacquer. Upholstered seats with textile, imitation leather, or leather. Leather from selected premium leather suppliers. Frame in powder-coated steel. Plastic glides.</p> <p>Oak veneer and Stained Dark Brown: slight color variations can occur due to the material's inherent characteristics.</p>
Cleaning & Care	<p>Clean with a moist cloth first and wipe off excess liquid with a dry cloth. Please note that wooden products will get a patina where the surface color can slightly fade. If cleaning is uneven, the patina may be more noticeable. For wooden products in lighter colors, the patina will be less noticeable.</p> <p>For textile upholstered versions: In case of stains, we generally recommend removing non-greasy stains by carefully dabbing them with a lint-free cloth or sponge wrung out in clean, warm water. Clean by dabbing with soapy water made with a bit of dish soap if necessary. Finally, dab the surface with clean water. We advise visiting Kvadrat.dk, Nevotex.dk, Maharam.com, or Gabriel.dk for further cleaning and maintenance instructions for your chosen textile, as the cleaning methods may vary from one textile to another.</p> <p>Imitation Leather: Clean with lukewarm PH-neutral, soapy water and a soft cloth or soft brush. Do not use solvents or chemical cleaners, but cleaning can be done with alcohol-based cleaners. Finally, wipe with a damp cloth afterward.</p> <p>Leather: As a natural material, leather requires looking after. If you care for the leather correctly, it will become even more beautiful over time.</p> <p>Refine Leather, Easy Leather, and Endure Leather: Regularly clean leather with a dry cloth. Treat the leather at least four times a year using only special leather treatment products. Visit ca-mo.com for further information on cleaning leather.</p> <p>Allure and Grace Leather: Only vacuum clean with a soft brush. Never use soap or water; otherwise, the velvety look and feel will disappear. Do not apply leather grease or soak the leather. Avoid chemical products, such as saddle soap, leather cleaners, or household products.</p>
Spare Parts	Pre-mounted plastic glides included. Felt and plastic glides can be purchased separately.

CUSTOMIZED UPHOLSTERY

Textile upholstery: 0,32 m / 0.35 yds — Leather upholstery: 0,63 m² / 6.78 ft²

TESTS & CERTIFICATIONS

EN 16139:2013 - L2

Extreme use. Furniture - Strength, durability and safety. Requirements for non-domestic seating.

EN 1022:2005

Domestic furniture - Seating - Determination of stability.

ANSI/BIFMA X5.4-2012

American National Standard For Office Furnishings. Lounge and Public Seating.

Declare.

Loft Chair without upholstery and EU/US versions upholstered with a large selection of Kvadrat textiles¹ are Declare Living Building Challenge Red List Approved.

VOC CDPH 01350 & VOC BIFMA X7.1.

Loft Chair without upholstery and EU/US versions upholstered with a large selection of Kvadrat textiles¹ are tested to VOC CDPH 01350 and VOC BIFMA X7.1.

¹Upholstered Muuto products that have the Declare Living Building Challenge Red List Approved certification only have the certification when upholstered with the following Kvadrat textiles: Balder, Canvas, Clara, Clay, Divina, Divina MD, Divina mélange, Fiord, Hallingdal, Hero, Remix, Re-wool, Steelcut, Steelcut Trio, Vidar, Twill weave.

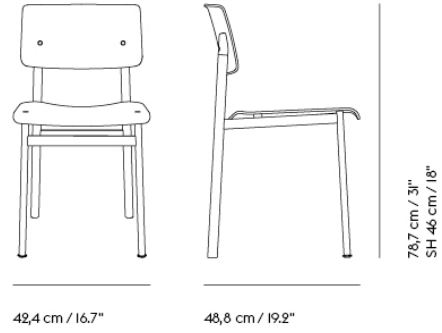

Shipper Colli	1
Gross Weight (kg)	15
Net Weight (kg)	6.6
Base color options	Black, Deep Red, Dusty Green or Grey
Warranty Period	10 years

Pattern No.	Color	Contract Price	Lead Time
Ready-To-Ship US Warehouse			
MLFTCW-BLCK-BLCK	Black/Black	USD 530.00	-
MLFTCW-BLCK-OAK	Oak/Black	USD 530.00	-
MLFTCW-DPRD-OAK	Oak/Deep Red	USD 530.00	-
MLFTCW-DGRN-OAK	Oak/Dusty Green	USD 530.00	-
MLFTCW-GREY-OAK	Oak/Grey	USD 530.00	-
MLFTCW-WHIT-OAK	Oak/White ***	USD 530.00	-
MLFTCW-BLCK-STDB	Stained Dark Brown/Black	USD 530.00	-
Extras			
80168	80I68		-
80169	80I69		-
MGLDLFSPB4	Plastic and felt glides for Loft Series (4 pcs per pack) - Black	USD 21.00	-
MLEAKIT	Leather care set for Refine Leather	USD 27.00	-

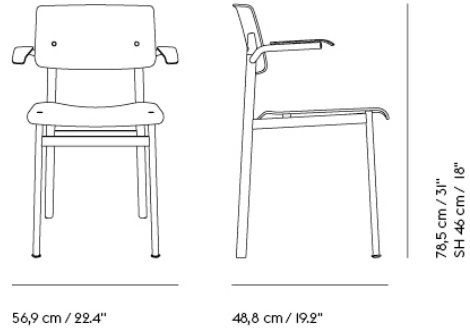

Shipper Colli 1
Gross Weight (kg) 17
Net Weight (kg) 7
Warranty Period 10 Years

Pattern No.	Color	Contract Price	Lead Time
Ready-To-Ship US Warehouse			
MLFTCAW-BLCK-BLCK	Black/Black	USD 688.00	-
MLFTCAW-BLCK-OAK	Oak/Black	USD 688.00	-
MLFTCAW-DPRD-OAK	Oak/Deep Red	USD 688.00	-
MLFTCAW-DGRN-OAK	Oak/Dusty Green	USD 688.00	-
MLFTCAW-GREY-OAK	Oak/Grey	USD 688.00	-
MLFTCAW-BLCK-STDB	Stained Dark Brown/Black	USD 688.00	-
Extras			
80168	80168		-
80169	80169		-
MGLDLFSPB4	Plastic and felt glides for Loft Series (4 pcs per pack) - Black	USD 21.00	-

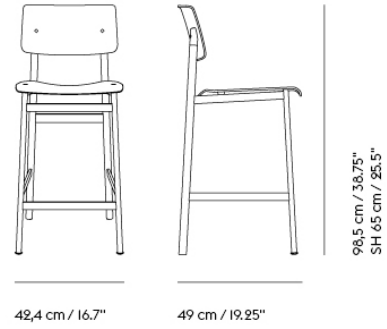

Shipper Colli	1
Gross Weight (kg)	11.55
Net Weight (kg)	8
Base color options	Black, Deep Red, Dusty Green or Grey
Warranty Period	10 years

Pattern No.	Color	Contract Price	Lead Time
-------------	-------	----------------	-----------

Ready-To-Ship US Warehouse

MLFTSTCW-BLCK-BLCK	Black/Black	USD 688.00	-
MLFTSTCW-BLCK-OAK	Oak/Black	USD 688.00	-
MLFTSTCW-DPRD-OAK	Oak/Deep Red	USD 688.00	-
MLFTSTCW-DGRN-OAK	Oak/Dusty Green	USD 688.00	-
MLFTSTCW-GREY-OAK	Oak/Grey	USD 688.00	-
MLFTSTCW-BLCK-STDB	Stained Dark Brown/Black	USD 688.00	-

Extras

80168	80I68		-
80169	80I69		-
MGLDLFSPB4	Plastic and felt glides for Loft Series (4 pcs per pack) - Black	USD 21.00	-
MLEAKIT	Leather care set for Refine Leather	USD 27.00	-

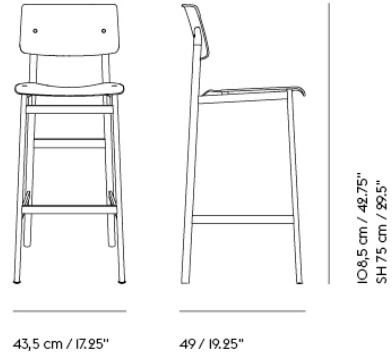
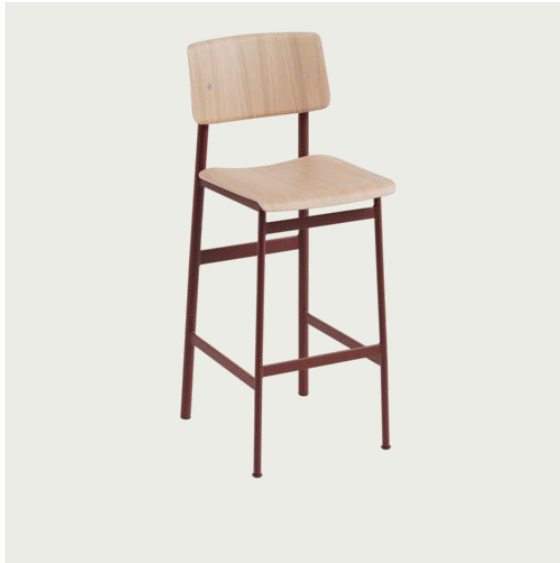

Shipper Colli	1
Gross Weight (kg)	12.05
Net Weight (kg)	8.5
Base color options	Black, Deep Red, Dusty Green or Grey
Warranty Period	10 years

Pattern No.	Color	Contract Price	Lead Time
Ready-To-Ship US Warehouse			
MLFTSTBW-BLCK-BLCK	Black/Black	USD 688.00	-
MLFTSTBW-BLCK-OAK	Oak/Black	USD 688.00	-
MLFTSTBW-DPRD-OAK	Oak/Deep Red	USD 688.00	-
MLFTSTBW-DGRN-OAK	Oak/Dusty Green	USD 688.00	-
MLFTSTBW-GREY-OAK	Oak/Grey	USD 688.00	-
Ready-To-Ship EU Warehouse			
MLFTSTBW-BLCK-STDB	Stained Dark Brown/Black ***	USD 688.00	-
Extras			
80168	80I68		-
80169	80I69		-
MGLDLFSPB4	Plastic and felt glides for Loft Series (4 pcs per pack) - Black	USD 21.00	-
MLEAKIT	Leather care set for Refine Leather	USD 27.00	-

LOFT CHAIR & STOOL



All Upholstery Variants

			Upholstery Grades								
			COM		CIL			COL			
	Description	Pattern No.	A	B	C	E	R	T	U	V	W
Loft Chair	Upholstered Seat	M-LFTC-U	734	776	824	845	866	919	954	1,101	1,206
Loft Counter Stool	Upholstered Seat	M-LFTST-C-U	902	944	1,013	1,028	1,049	1,150	1,150	1,206	1,206
Loft Bar Stool	Upholstered Seat	M-LFTST-B-U	902	944	1,013	1,028	1,049	1,150	1,150	1,206	1,206

HOW TO CONFIGURE

ORDER CODE EXAMPLE: Loft w/upholstered Seat

Loft Chair

Oak/Black Hallingdal 810

Specify:

- Step 1) Choose variant
- Step 2) Choose Base color
- Step 3) Choose Back/seat color
- Step 4) Choose Upholstery
- Step 5) Choose Upholstery color

Variant	Loft Chair Upholstered seat	M-LFT-CU
Base Color	Black	BLCK
Back/seat color	Oak	OAK
Upholstery	Hallingdal	M146
Upholstery Color	226	810
Final Pattern No:	MLFTCUBLCKOAKM146810	

Base/Wood Options

Steel Base and Wooden Seat/back are combined as follows

- BLCK-BLCK - Black/Black wood
- BLCK-OAK - Black/Oak
- DGRN-OAK - Dusty Green/Oak
- BLCK-STDB - Black/Stained Dark Brown wood
- GREY-OAK - Grey/Oak
- DPRD-OAK - Deep Red/Oak
- GREY-STDB - Grey / Stained Dark Brown wood

Upholstery Options

A	B	C	E	R	T	U	V	W
Ocean (M161)* Remix (M156)	Canvas (M153) Clara (M154) Grain (M12659) Manner (M12665) Steelcut (M149) Steelcut Trio (M139)	Hallingdal (M146)	Acca (M12660) Beck (M6376) Divina (M150) Divina MD (M147) Divina Melange (M135) Ecriture (M10767) Hearth (M12664) Twill Weave (M142)	Easy Leather (M141)	Refine Leather (M136)	Endure Leather (M137)	Grace Leather (M12374)	Allure Leather (M12375)

*Notes:
Ocean - Color 3, 21, 32, 50, 52, 80 & 601

MIDST TABLE

“Midst Table is a meeting between the poetic and functional. The name refers to the center and the table being a gravitational point, while its round shape cancels out hierarchy — there is no head of the table. Its shape naturally draws us in towards its middle, encouraging a meeting of minds and eyes. Our design process was one of subtraction and refinement. The Midst Table’s form and construction was inspired by an iconic architectural feature, the column, merging a physical stability and steadfastness with a sense of elegance.”

— TAF Studio



Designed by	TAF Studio
Environment	Indoor
Country of Production	Base: Latvia / Tabletop Linoleum: Sweden / Tabletop Solid Oak & Dark Oiled Oak: Bosnia & Herzegovina
Assembly Required	Yes
Description	A natural focal point of the home, the Midst Table is a generous, round dining table where friends and family gather — and there is always room to squeeze in one more guest. Its refined silhouette is simple yet characteristic, enhanced by distinct detailing and contrasting materiality; matte solid oak or linoleum on a monolithic base made of spun steel with a durable high gloss finish.
Material	Table top in lacquered MDF with a linoleum top or FSC™-certified (FSC-CO28824) solid oak, treated with either a white pigmented or dark oil. Base in powder-coated steel with a protective rubber ring under the base.
Cleaning & Care	<p>Linoleum: Clean the tabletop with a damp cloth. If necessary, only use a mild detergent or washing-up liquid, never concentrated. Always wipe with a dry cloth afterward. To minimize the risk of stains and marks, liquid, grease etc. should be removed straight away. For linoleum versions, linoleum care is recommended 2-3 times a year for optimum saturation of the natural material. Clean base with a microfiber cloth to avoid scratching the high gloss lacquer. If necessary use a small amount of mild dish soap on the cloth.</p> <p>Solid Oak & Dark Oiled Oak: Upon receiving your table, we recommend that the table top and bottom is treated with a special oak wood oil, improving its resistance to stains and fluids. We also recommend that you continue caring for the product by repeating this treatment 2-3 times a year. For products in Solid Oak, we recommend using a tabletop oil with a small amount of white pigment, suitable for food applications*. For products in Dark Oiled Oak, we recommend using a smoked tabletop oil, suitable for food applications*.</p> <p>Avoid placing the table in the immediate distance of a heat source. Do not place hot or wet objects directly on the table, as they can leave a mark on the table top. Metal objects can leave a mark if left on the table for a longer period of time.</p> <p>Spills should immediately be removed to avoid discoloring. Clean the tabletop often and carefully with a soft and dry cloth following the wood grain pattern. The product should not be exposed to excessive humidity, heat or direct sunlight. Clean base with a microfibre cloth to avoid scratching the high gloss paint. If necessary, use a small amount of mild dish soap on the cloth.</p> <p>*Muuto recommends that you contact your local hardware store to get advice on oils for indoor use.</p>

MIDST TABLE

	TESTS & CERTIFICATIONS
EN 15372:2016 - L3	Extreme use. Furniture – Strength, durability and safety. Requirements for non-domestic tables.
ANSI/BIFMA X5.5-2021	American National Standard for Office. Furnishings - Desk Products.
Forest Stewardship Council™	Tabletop in Solid Oak is made from FSC™-certified (FSC-CO28824) wood.
VOC CDPH 01350 & VOC BIFMA X7.1.	Tabletops in Solid Oak and Dark Oiled Oak is VOC CDPH 01350 and VOC BIFMA X7.1. tested.

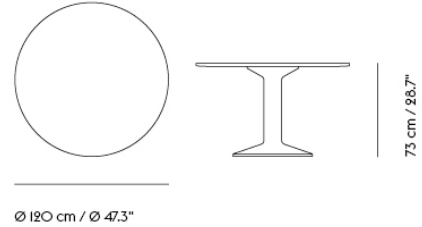

Shipper Colli 2
Gross Weight (kg) 67.09
Net Weight (kg) 48.996
Please note Other color combinations are available upon request
Warranty Period 10 years

Pattern No.	Color	Contract Price	Lead Time
Ready-To-Ship EU Warehouse			
MMDSTT47-BLCK-BLCK	Black Linoleum/Black	USD 4,146.00	-
MMDSTT47-DKRD-DKRD	Dark Red Linoleum/Dark Red	USD 4,146.00	-
MMDSTT47-DOAK-BLCK	Dark Oiled Oak/Black	USD 4,405.00	-
MMDSTT47-DOAK-DKRD	Dark Oiled Oak/Dark Red	USD 4,405.00	-
MMDSTT47-DOAK-GREY	Dark Oiled Oak/Grey	USD 4,405.00	-
MMDSTT47-OAK-BLCK	Oiled Oak/Black	USD 4,405.00	-
MMDSTT47-OAK-DKRD	Oiled Oak/Dark Red	USD 4,405.00	-
MMDSTT47-OAK-GREY	Oiled Oak/Grey	USD 4,405.00	-

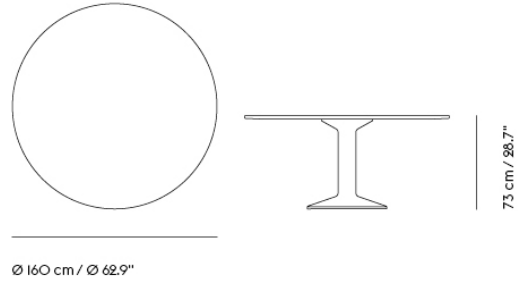

Shipper Colli 2
Gross Weight (kg) 96.98
Net Weight (kg) 74.217
Please note Other color combinations are available upon request
Warranty Period 10 years

Pattern No.	Color	Contract Price	Lead Time
Ready-To-Ship EU Warehouse			
MMDSTT63-BLCK-BLCK	Black Linoleum/Black	USD 5,770.00	-
MMDSTT63-DKRD-DKRD	Dark Red Linoleum/Dark Red	USD 5,770.00	-
MMDSTT63-DOAK-BLCK	Dark Oiled Oak/Black	USD 6,715.00	-
MMDSTT63-DOAK-DKRD	Dark Oiled Oak/Dark Red	USD 6,715.00	-
MMDSTT63-DOAK-GREY	Dark Oiled Oak/Grey	USD 6,715.00	-
MMDSTT63-OAK-BLCK	Oiled Oak/Black	USD 6,715.00	-
MMDSTT63-OAK-DKRD	Oiled Oak/Dark Red	USD 6,715.00	-
MMDSTT63-OAK-GREY	Oiled Oak/Grey	USD 6,715.00	-

MINI STACKED STORAGE SYSTEM

"The design aims at identifying this very intricate space in the world of shelving where storage, display and versatility becomes one. I have moved homes countless of times and it has made me see my belongings in a new light, valuing their ability to adapt to new and ever-changing surroundings to a high degree."

— Julien De Smedt



Designed by	Julien De Smedt
Environment	Indoor
Country of Production	Slovenia
Assembly Required	Yes - please carefully read and fully adhere to the assembly guidelines when assembling your Stacked Storage System.
Description	The Mini Stacked is a wall-hanging alternative to the Stacked Storage System with a lighter expression and smaller dimensions, available across various sizes and colors. The Mini Stacked Storage System is an elegantly functional match for smaller spaces such as kitchens, hallways, bedrooms, and workplace and hospitality settings.
Material	<p>Modules in PU lacquered MDF or Oak veneered fiberboard. Clips are powder-coated bent steel with rubber inserts.</p> <p>Lacquered versions: Every side is cut out of MDF, glued together, and painted with three layers of PU lacquer.</p> <p>Oak versions: Every side is cut out of fiberboard with oak veneer and glued together.</p>
Cleaning & Care	<p>Natural Oak Modules Avoid using any liquid on Natural Veneer Stacked variants. Remove dust from shelves with a soft cloth. Dry any spillages immediately with a soft cloth following the wood grains. The wood should not be exposed to excessive heat, direct sunlight, or humidity. The wood surface finish will naturally fade over time.</p> <p>Lacquered Modules Clean the modules with a damp cloth. If necessary, only use a mild detergent or washing-up liquid, not concentrated. Always wipe with a dry cloth afterward. To minimize the risk of stains and marks, liquid, grease, etc., should be removed immediately. The wood should not be exposed to excessive heat, direct sunlight, or humidity. Take care when placing or moving objects on the surfaces of Stacked as scratches can quickly occur.</p> <p>Metal Surfaces Powder-coated surfaces: Clean with a moist cloth. If necessary, use a little dish soap on the cloth.</p>
Spare Parts	Each Mini Stacked module comes with one color matching clips, while Oak comes with Grey clips. Extra clips available (1 pc) in the colors White, Grey and Brown Green.

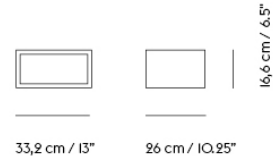

Shipper Colli 1
Gross Weight (kg) 4.2
Net Weight (kg) 2.7
Warranty Period 5 years

Pattern No.	Color	Contract Price	Lead Time
Ready-To-Ship US Warehouse			
MMSTMSM-GREY	Grey ***	USD 226.00	-
MMSTMSM-MBLU	Midnight Blue	USD 226.00	-
MMSTMSM-OAK	Oak	USD 226.00	-
MMSTMSM-WHIT	White	USD 226.00	-

MINI STACKED STORAGE SYSTEM / MEDIUM

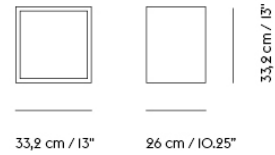

Shipper Colli 1
Gross Weight (kg) 5.5
Net Weight (kg) 3.7
Warranty Period 5 years

Pattern No.	Color	Contract Price	Lead Time
Ready-To-Ship US Warehouse			
MMSTMMD-GREY	Grey ***	USD 226.00	-
MMSTMMD-MBLU	Midnight Blue	USD 226.00	-
MMSTMMD-OAK	Oak	USD 226.00	-
MMSTMMD-OLIGY	Oak/Grey	USD 226.00	-
MMSTMMD-WHIT	White	USD 226.00	-

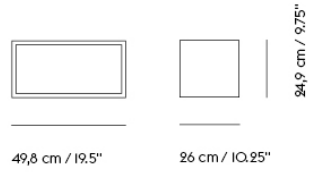

Shipper Colli 1
Gross Weight (kg) 6.195
Net Weight (kg) 4.3
Warranty Period 5 years

Pattern No.	Color	Contract Price	Lead Time
Ready-To-Ship US Warehouse			
MMSTMLG-GREY	Grey ***	USD 236.00	-
MMSTMLG-MBLU	Midnight Blue	USD 236.00	-
MMSTMLG-OAK	Oak	USD 236.00	-
MMSTMLG-WHIT	White	USD 236.00	-

MINI STACKED STORAGE SYSTEM / CLIPS SET OF 5



Shipper Colli	1
Gross Weight (kg)	0.077
Net Weight (kg)	0.071
Warranty Period	5 years

Pattern No.	Color	Contract Price	Lead Time
Ready-To-Ship US Warehouse			
MMSTC-GREY	Grey - Set of 5	USD 39.00	-
MMSTC-LIGY	Light Grey - Set of 5	USD 39.00	-
MMSTC-MBLU	Midnight Blue - Set of 5	USD 39.00	-
MMSTC-WHIT	White - Set of 5	USD 39.00	-
Ready-To-Ship EU Warehouse			
MMSTC-DGRN	Dusty Green - Set of 5	USD 39.00	-

NERD CHAIR SERIES

"The Nerd Chair Series takes a playful approach to the archetypical wooden chair through its innovative integration of seat and back, adding to the design's unique expression. While its details are contemporary and unique in their own way, the overall expression of the design ties in with the honest values of Scandinavian design. The Nerd Chair Series brings new perspectives to Scandinavian design by combining the traditional material of wood with a simple yet eccentric design language, making for a timeless chair that adds character to any space."

— David Geckeler



Designed by	David Geckeler
Environment	Indoor
Country of Production	Latvia
Assembly Required	No
Description	The Nerd Chair Series is designed with a playfully contemporary expression, joined by its wooden Scandinavian materiality. The seamless integration of its back and seat makes for a characterful detail alongside the curved edges of its seat. The series includes a Chair, a Bar Stool and a Counter Stool.
Material	The back and seat are made from form-pressed veneer alongside legs in solid wood, both with a water-based lacquer.
Cleaning & Care	Clean on a regular basis using a damp and clean cloth. Remove stains using a mild mixture of water and detergent. Avoid contact with sharp objects as these can leave scratches in the wood and lacquer.
Spare Parts	Plastic glides included. Option of pre-mounted felt glides upon request for orders above 50 chairs.
Made-To-Order	Counter and Bar Stool: steel foot protect is available as made-to-order.
EN 16139:2013 - L2	TESTS & CERTIFICATIONS Extreme use. Furniture - Strength, durability and safety. Requirements for non-domestic seating.
EN 1092:2005	Domestic furniture - Seating. Determination of stability.
Global GreenTag GreenRate™	Nerd Chair and Bar Stools are Global GreenTag GreenRate Level C certified. <i>Please note that the Global GreenTag Label only applies for contract market orders with a minimum 5-year warranty.</i>
Declare.	Nerd Chair and Bar Stools are Declare Living Building Challenge Red List Approved.
VOC CDPH 01350 & VOC BIFMA X7.1.	Nerd Chair and Bar Stools are tested to VOC CDPH 01350 and VOC/BIFMA X7.1.

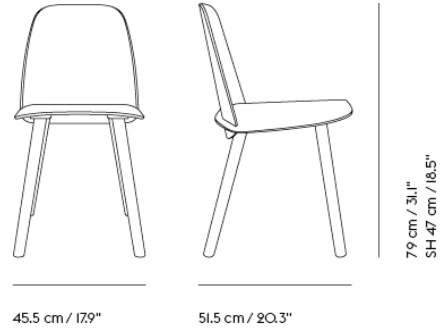

Shipper Colli 1
Gross Weight (kg) 6.9
Net Weight (kg) 4.5
Warranty Period 5 years

Pattern No.	Color	Contract Price	Lead Time
Ready-To-Ship US Warehouse			
MNRDCW-BLCK	Black	USD 572.00	-
MNRDCW-GREN	Green	USD 572.00	-
MNRDCW-GREY	Grey	USD 572.00	-
MNRDCW-MBLU	Midnight Blue	USD 572.00	-
MNRDCW-OAK	Oak	USD 572.00	-
MNRDCW-SYEL	Sand Yellow ***	USD 572.00	-
MNRDCW-STDB	Stained Dark Brown	USD 572.00	-
MNRDCW-TROS	Tan Rose	USD 572.00	-
MNRDCW-WHIT	White	USD 572.00	-
Extras			
MGLDNSWCFB4	Felt glides for Nerd Series and Workshop Chair and Bench (4 pcs per pack) - Black	USD 21.00	-
MGLDNSWCFG4	Felt glides for Nerd Series and Workshop Chair and Bench (4 pcs per pack) - Grey	USD 21.00	-
COM/COL & Specials			
32010	Special Color	USD 650.00	>MOQ: 24 Start-Up Fee: USD 1,195.00
			17-19 weeks

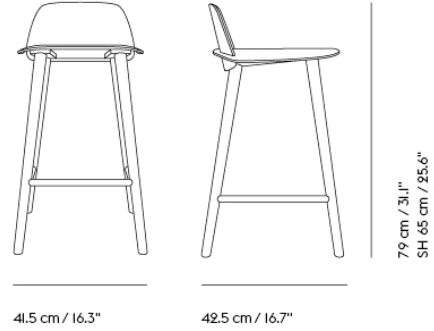

Shipper Colli 1
Gross Weight (kg) 5.6
Net Weight (kg) 4.3
Warranty Period 5 years

Pattern No.	Color	Contract Price	Lead Time
Ready-To-Ship US Warehouse			
MNRDSTCW-BLCK	Black	USD 667.00	-
MNRDSTCW-GREN	Green	USD 667.00	-
MNRDSTCW-GREY	Grey	USD 667.00	-
MNRDSTCW-MBLU	Midnight Blue	USD 667.00	-
MNRDSTCW-OAK	Oak	USD 667.00	-
MNRDSTCW-STD	Stained Dark Brown	USD 667.00	-
MNRDSTCW-TROS	Tan Rose	USD 667.00	-
Ready-To-Ship EU Warehouse			
MNRDSTCW-SYEL	Sand Yellow	USD 667.00	-
Made-To-Order			
MNRDSTCWF-BLCK	Black - With Steel Foot Protect	USD 719.00	13-15 weeks
MNRDSTCWF-GREN	Green - With Steel Foot Protect	USD 719.00	13-15 weeks
MNRDSTCWF-GREY	Grey - With Steel Foot Protect	USD 719.00	13-15 weeks
MNRDSTCWF-MBLU	Midnight Blue - With Steel Foot Protect	USD 719.00	13-15 weeks
MNRDSTCWF-OAK	Oak - With Steel Foot Protect	USD 719.00	13-15 weeks
MNRDSTCWF-SYEL	Sand Yellow - With Steel Foot Protect	USD 719.00	13-15 weeks
MNRDSTCWF-STD	Stained Dark Brown - With Steel Foot Protect	USD 719.00	13-15 weeks
MNRDSTCWF-TROS	Tan Rose - With Steel Foot Protect	USD 719.00	13-15 weeks

Pattern No.	Color	Contract Price	Lead Time
Extras			
MGLDNSWCFB4	Felt glides for Nerd Series and Workshop Chair and Bench (4 pcs per pack) - Black	USD 21.00	-
MGLDNSWCFG4	Felt glides for Nerd Series and Workshop Chair and Bench (4 pcs per pack) - Grey	USD 21.00	-
MFTRSTN	Steel Footrest Protector - Self-Mounting	USD 48.00	-
COM/COL & Specials			
32040	Special Color	USD 719.00	>MOQ: 24 Start-Up Fee: USD 1,195.00
			17-19 weeks

NERD BAR STOOL / 75 CM / 29.5"

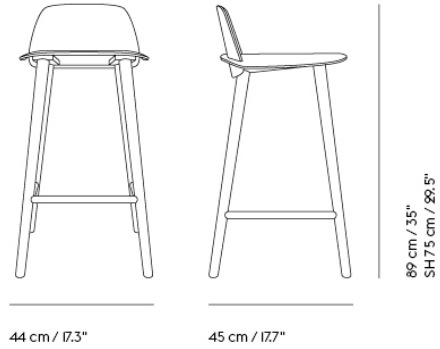

Shipper Colli	1
Gross Weight (kg)	5.6
Net Weight (kg)	4.3
Warranty Period	5 years

Pattern No.	Color	Contract Price	Lead Time
Ready-To-Ship US Warehouse			
MNRDSTBW-BLCK	Black	USD 667.00	-
MNRDSTBW-GREN	Green	USD 667.00	-
MNRDSTBW-GREY	Grey	USD 667.00	-
MNRDSTBW-MBLU	Midnight Blue	USD 667.00	-
MNRDSTBW-OAK	Oak	USD 667.00	-
MNRDSTBW-SYEL	Sand Yellow	USD 667.00	-
MNRDSTBW-STD	Stained Dark Brown	USD 667.00	-
MNRDSTBW-TROS	Tan Rose	USD 667.00	-
MNRDSTBW-WHIT	White	USD 667.00	-
Made-To-Order			
MNRDSTBWF-BLCK	Black - With Steel Foot Protect	USD 719.00	13-15 weeks
MNRDSTBWF-GREN	Green - With Steel Foot Protect	USD 719.00	13-15 weeks
MNRDSTBWF-GREY	Grey - With Steel Foot Protect	USD 719.00	13-15 weeks
MNRDSTBWF-MBLU	Midnight Blue - With Steel Foot Protect	USD 719.00	13-15 weeks
MNRDSTBWF-OAK	Oak - With Steel Foot Protect	USD 719.00	13-15 weeks
MNRDSTBWF-SYEL	Sand Yellow - With Steel Foot Protect	USD 719.00	13-15 weeks
MNRDSTBWF-STD	Stained Dark Brown - With Steel Foot Protect	USD 719.00	13-15 weeks
MNRDSTBWF-TROS	Tan Rose - With Steel Foot Protect	USD 719.00	13-15 weeks

Extras

Pattern No.	Color	Contract Price	Lead Time
MGLDNSWCFB4	Felt glides for Nerd Series and Workshop Chair and Bench (4 pcs per pack) - Black	USD 21.00	-
MGLDNSWCFG4	Felt glides for Nerd Series and Workshop Chair and Bench (4 pcs per pack) - Grey	USD 21.00	-
MFTRSTN	Steel Footrest Protector - Self-Mounting	USD 48.00	-

COM/COL & Specials

32070	Special Color	USD 719.00	>MOQ: 24 Start-Up Fee: USD 1,195.00	17-19 weeks
32140	Special Color - With Steel Foot Protect	USD 755.00	>MOQ: 24 Start-Up Fee: USD 1,195.00	17-19 weeks

OSLO SERIES

“With the Oslo Sofa series, we wanted to create a design that had a light and airy appearance with extensive comfort. Its smooth, embracing curves makes it a both inviting and sculptural design while the slender legs give it an elevated and refined look. The Oslo Series brings a new perspective, with its rounded softness and gentle seat—a friendly design for any setting of the modern home and office.”

— Anderssen & Voll



Designed by	Anderssen & Voll
Environment	Indoor
Country of Production	Poland
Assembly Required	Yes: 1-Seater, 2-Seater & 3-Seater (Sofa Series) No: Lounge Chair, Side Chair, Counter and Bar Stool
Description	Combining modern, geometric lines with a light expression and comfortably soft seat, the Oslo Series brings a refined perspective to the form through its playful lines and embracing back.
Material	<p>Sofa Series & Bench: Seat in molded PU Foam with embedded steel frames and zig-zag springs. Fully upholstered with textile, imitation leather, or leather. Leather from selected premium leather suppliers. Legs in chromed or powder-coated steel with felt glides.</p> <p>Lounge Chair: Seat and back in molded PU foam with embedded steel and wood frame. Fully upholstered with textile, imitation leather, or leather. Leather from selected premium leather suppliers. Tube base in powder-coated steel with plastic glides. Swivel base in powder-coated steel with plastic glides.</p>
Cleaning & Care	<p>Textile: For textile upholstered versions: In case of stains, we generally recommend removing non-greasy stains by carefully dabbing with a lint-free cloth or sponge wrung out in clean, warm water. If necessary, clean by dabbing with soapy water made with a little dish soap. Finally, dab the surface with clean water. We highly recommend that you go to kvadrat.dk for further cleaning and maintenance instructions for your chosen textile, as the cleaning methods may vary from one textile to another.</p> <p>Imitation Leather: Clean with lukewarm PH-neutral, soapy water and a soft cloth or soft brush. Do not use solvents or chemical cleaners, but cleaning can be done with alcohol-based cleaners. Finally, wipe with a damp cloth afterward.</p> <p>Leather: As a natural material, leather requires looking after. If you care for the leather correctly, it will become even more beautiful over time.</p> <p>Refine Leather, Easy Leather, and Endure Leather: Clean leather with a dry cloth regularly. Treat the leather at least four times a year using only special leather treatment products. Visit ca-mo.com for further information on cleaning leather.</p> <p>Allure and Grace Leather: Only vacuum clean with a soft brush. Never use soap or water; otherwise, the velvety look and feel will disappear. Do not apply leather grease or soak the leather. Avoid chemical products, such as saddle soap, leather cleaners, or household products.</p> <p>Base: Clean with a moist cloth. If necessary, use a little dish soap on the cloth.</p>
Spare Parts	For Side Chair, Counter and Bar Stool, plastic glides are included. Felt glides are sold separately.

Side Chair
 Counter & Bar Stool
 1-Seater
 2-Seater
 3-Seater
 Oslo Lounge Chair
 Pouf
 Bench

CUSTOMIZED UPHOLSTERY

Textile upholstery: 1,4 m / 1.5 yds
 Textile upholstery: 1,2 m / 1.3 yds
 Textile upholstery: 2,7 m / 3.0 yds — Leather upholstery: 3 m² / 32.3 ft²
 Textile upholstery: 3,8 m / 4.2 yds — Leather upholstery: 6,5 m² / 69.9 ft²
 Textile upholstery: 4,8 m / 5.3 yds — Leather upholstery: 7,5 m² / 80.7 ft²
 Textile upholstery: 1,9 m / 2.1 yds — Leather upholstery: 2,4 m² / 25.8 ft²
 Textile upholstery: 1,3 m / 1.4 yds — Leather upholstery: 2 m² / 21.5 ft²
 Textile upholstery: 2,0 m / 2.2 yds — Leather upholstery: 3 m² / 32.3 ft²

TESTS & CERTIFICATIONS

EN 16139:2013 - L2

Extreme use. Furniture - Strength, durability and safety.
 Requirements for non-domestic seating.

Please note that this test does not apply to Oslo Bar & Counter Stool

EN 1022:2005

Domestic furniture - Seating - Determination of stability.

Please note that this test does not apply to Oslo Bar & Counter Stool

ANSI/BIFMA X5.1-2017

Oslo Counter & Bar Stool:
 American National Standard for Office Furnishings-General purpose Office Chairs.

ANSI/BIFMA X5.4-2012*

Oslo Sofa Series:
 American National Standard For Office Furnishings. Lounge and Public Seating.
 *Oslo Side Chair is available as Made-To-Order with ANSI/BIFMA X5.4-2012.

ANSI/BIFMA X5.4-2020

Oslo Lounge Chair:
 American National Standard For Office Furnishings. Lounge and Public Seating.

Declare.*

EU/US versions of the Oslo Series that are upholstered with a large selection of Kvadrat textiles¹ are Living Building Challenge Red List Approved as part of Muuto's participation in Declare.

VOC CDPH 01350 &
 VOC BIFMA X7.1.

Oslo Series in EU/US versions upholstered with a large selection of Kvadrat textiles² are tested to VOC CDPH 01350 and VOC BIFMA X7.1.

¹Upholstered Muuto products that have the Declare Living Building Challenge Red List Approved certification only have the certification when upholstered with the following Kvadrat textiles: Canvas, Clara, Divina, Divina MD, Divina mélange, Fiord, Hallingdal, Remix, Steelcut, Steelcut trio, Vidar, Hero, Balder, Ocean.

²Upholstered Muuto products that are tested to VOC CDPH 01350 and VOC BIFMA X7.1 are only compliant when upholstered with the following Kvadrat textiles: Balder, Canvas, Clara, Clay, Divina, Divina MD, Divina mélange, Fiord, Hallingdal, Hero, Ocean, Remix, Re-wool, Steelcut, Steelcut Trio, Still, Vidar, Twill weave.

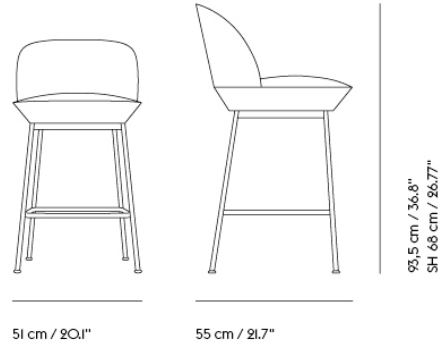

Shipper Colli	1
Gross Weight (kg)	10
Net Weight (kg)	8
Base color options	Chrome or Anthracite Black
Warranty Period	10 years

Pattern No.	Color	Contract Price	Lead Time
Ready-To-Ship US Warehouse			
MOSLSTCU-CHRO-M16132	Ocean 32/Chrome ***	USD 1,045.00	-
Extras			
80173	Grey	USD 6.00	-
MGLDOFVTBPB1	Plastic glides for Oslo, Fiber and Visu with Tube Base (1 pc per pack) - Black	USD 6.00	-
MGLDOFVTBFB4	Felt Glides for Oslo, Fiber and Visu with Tube Base (4 pcs per pack)	USD 21.00	-

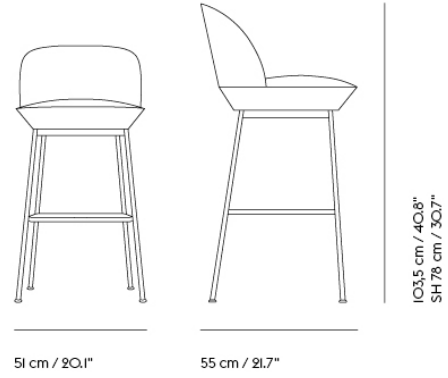

Shipper Colli	I
Gross Weight (kg)	11
Net Weight (kg)	8.2
Base color options	Chrome or Anthracite Black
Warranty Period	10 years

Pattern No.	Color	Contract Price	Lead Time
Ready-To-Ship US Warehouse			
MOSLSTBU-CHRO-M16132	Ocean 32/Chrome ***	USD 1,045.00	-
Extras			
80173	Grey	USD 6.00	-
MGLDOFVTBPP1	Plastic glides for Oslo, Fiber and Visu with Tube Base (1 pc per pack) - Black	USD 6.00	-
MGLDOFVTBFB4	Felt Glides for Oslo, Fiber and Visu with Tube Base (4 pcs per pack)	USD 21.00	-

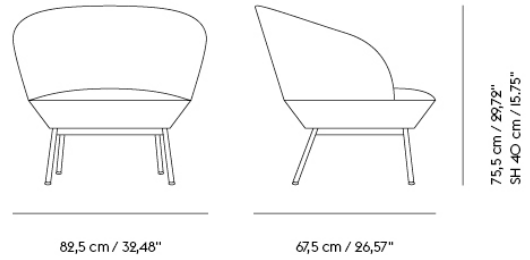

Shipper Colli	1
Gross Weight (kg)	23.5
Net Weight (kg)	21.5
Base color options	Black or Grey
Warranty period	10 years

Pattern No.	Color	Contract Price	Lead Time
Ready-To-Ship US Warehouse			
MOSLLCT-BLCK-M142990	Twill Weave 990/Black	USD 2,935.00	-
MOSLLCT-GREY-M158146	Vidar 146/Grey	USD 2,935.00	-
Extras			
82057	Felt Glides for Oslo Lounge Chair (4 pcs per pack)	USD 21.00	-
MLEAKIT	Leather care set for Refine Leather	USD 27.00	-

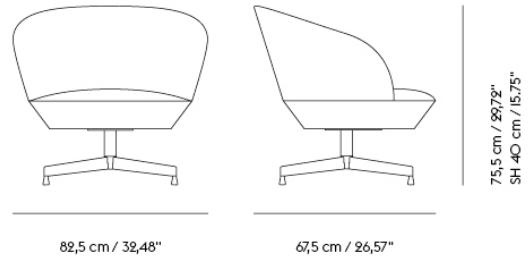

Shipper Colli	1
Gross Weight (kg)	23.5
Net Weight (kg)	21.5
Base color options	Black or Grey
Warranty period	10 years

Pattern No.	Color	Contract Price	Lead Time
Ready-To-Ship US Warehouse			
MOSLLCS-BLCK-M142990	Twill Weave 990/Black	USD 3,621.00	-
MOSLLCS-GREY-M158146	Vidar 146/Grey	USD 3,621.00	-
Extras			
82057	Felt Glides for Oslo Lounge Chair (4 pcs per pack)	USD 21.00	-
MLEAKIT	Leather care set for Refine Leather	USD 27.00	-

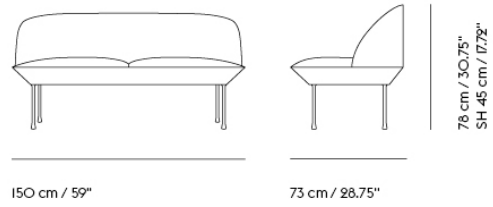

Shipper Colli	1
Gross Weight (kg)	34
Net Weight (kg)	31
Base color options	Black, Chrome, Dark Grey or Grey
Warranty Period	10 years

Pattern No.	Color	Contract Price	Lead Time
Ready-To-Ship US Warehouse			
MOSLSF2-NABL-M158554	Vidar 554/Navy Blue ***	USD 4,615.00	-
Extras			
MLEAKIT	Leather care set for Refine Leather	USD 27.00	-

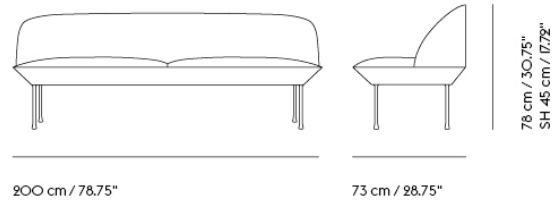

Shipper Colli	1
Gross Weight (kg)	49
Net Weight (kg)	44
Base color options	Black, Chrome, Dark Grey or Grey
Warranty Period	10 years

Pattern No.	Color	Contract Price	Lead Time
Ready-To-Ship US Warehouse			
MOSLSF3-DKGY-M149180	Steelcut 180/Dark Grey ***	USD 4,615.00	-
MOSLSF3-DKGY-M139966	Steelcut Trio 966/Dark Grey	USD 4,615.00	-
MOSLSF3-NABL-M158554	Vidar 554/Navy Blue ***	USD 5,406.00	-
Extras			
MLEAKIT	Leather care set for Refine Leather	USD 27.00	-

OSLO CHAIR & STOOL



OSLO CHAIR

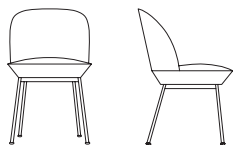

51 cm / 20.08" 56 cm / 22.05"

80,5 cm / 31.7"
SH 45 cm / 17.75"

OSLO COUNTER STOOL

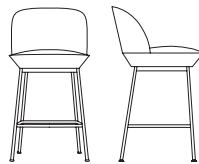

51 cm / 20.1" 55 cm / 21.7"

93,5 cm / 36.8"
SH 65 cm / 25.6"

OSLO BAR STOOL

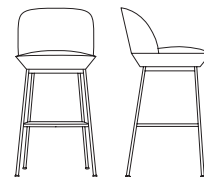

51 cm / 20.1" 55 cm / 21.7"

103,5 cm / 40.8"
SH 75 cm / 29.5"

All Variants

		Upholstery Grades			
		COM			
Pattern No.	A	B	C	E	
Oslo Side Chair	M-OSLS-U	954	1,045	1,150	1,150
Oslo Counter Stool	M-OSLST-C-U	1,045	1,150	1,255	1,255
Oslo Bar Stool	M-OSLST-B-U	1,045	1,150	1,255	1,255

HOW TO CONFIGURE

Specify:

- Step 1: Choose variant
- Step 2: Choose base color
- Step 3: Choose textile
- Step 4: Choose textile color

ORDER CODE EXAMPLE:

Oslo Side Chair in Steelcut Trio 226 w/chrome base

Variant	Oslo Side Chair	MOSLSU
Base Color	Chrome	CHRO
Textile	Steelcut Trio	M139
Textile Color	226	226
Final Pattern No:	MOSLSUCHROM139226	

Base Finish Options

- BLCK - Anthracite Black
- CHRO - Chrome

Upholstery Options

A	B	C	E
Ocean (M161)*	Clara (M154) Colline (M5416) Fiord (M155) Grain (M12659) Manner (M12665) Re-Wool (M4586) Sabi (M8404) Steelcut (M149) Steelcut Trio (M139)	Hallingdal (M146)	Acca (M12660) Beck (M6376) Divina (M150) Divina MD (M147) Divina Melange (M135) Ecriture (M10767) Hearth (M12664) Planum (M5904) Twill Weave (M142) Vidar (M158)

*Notes:
Ocean - Color 3, 21, 32, 50, 52, 80 & 601

OSLO SOFA SERIES



OSLO SOFA 3-SEATER

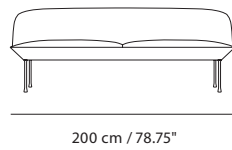

OSLO SOFA 2-SEATER

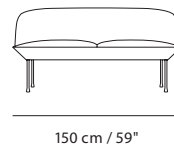

78 cm / 30.75"
SH 45 cm / 17.75"

OSLO SOFA 1-SEATER

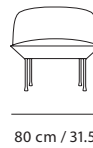

78 cm / 30.75"
SH 45 cm / 17.75"

OSLO BENCH

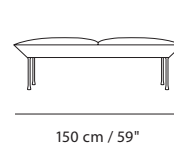

OSLO POUF

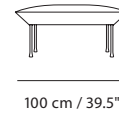

45 cm / 17.75"

Oslo Pouf:
Shipper colli 1
Gross Weight (kg) 17
Net Weight (kg) 16
Warranty Period 10 years

Oslo 1-Seater:
Shipper colli 1
Gross Weight (kg) 23
Net Weight (kg) 20
Warranty Period 10 years

Oslo Sofa 3-Seater:
Shipper colli: 1
Gross Weight (kg) 46
Net Weight (kg) 44
Warranty Period 10 years

Oslo Bench:
Shipper colli: 1
Gross Weight (kg) 34
Net Weight (kg) 32
Warranty Period 10 years

Oslo Sofa 2-Seater:
Shipper colli: 1
Gross Weight (kg) 34
Net Weight (kg) 32
Warranty Period 10 years

All Variants

	Pattern No.	Upholstery Grades								
		A	B	C	E	R	T	U	V	W
Oslo Sofa 2-seater	M-OSLSF-2	3,565	4,090	4,300	4,615	4,776	5,140	5,245	5,721	5,770
Oslo Sofa 3-seater	M-OSLSF-3	4,300	4,615	4,986	5,406	5,616	5,980	6,036	6,561	6,771
Oslo 1-Seater	M-OSLSF-1	2,305	2,515	2,676	2,935	3,096	3,516	3,565	4,090	4,146
Oslo Bench	M-OSLB	2,361	2,571	2,830	3,040	3,096	3,411	3,516	3,726	3,831
Oslo Pouf	M-OSLP	1,836	1,941	2,256	2,305	2,361	2,781	2,830	3,040	3,096

HOW TO CONFIGURE

Specify:
Step 1: Choose variant
Step 2: Choose base color
Step 3: Choose textile
Step 4: Choose textile color

ORDER CODE EXAMPLE:

Oslo 2-seater in Steelcut Trio 226 w/chrome base
Variant Oslo 2-seater MOSLSF2
Base Color Chrome CHRO
Textile Steelcut Trio M139
Textile Color 226
Final Pattern No: MOSLSF2CHROM139226

Base Finish Options

BLCK - Black
CHRO - Chrome
DKGY - Dark Grey
GREY - Grey

Upholstery Options

A	B	C	E	R	T	U	V	W
Ocean (M161)*	Canvas (M153) Clara (M154) Colline (M5416) Fiord (M155) Grain (M12659) Manner (M12665) Re-Wool (M4586) Sabi (M8404) Steelcut (M149) Steelcut Trio (M139)	Hallingdal (M146) Illusion (M12654)	Acca (M12660) Beck (M6376) Divina (M150) Divina MD (M147) Divina Melange (M135) Hearth (M12664) Planum (M5904) Twill Weave (M142) Vidar (M158)	Easy Leather (M141)	Refine Leather (M136)	Endure Leather (M137)	Grace Leather (M12374)	Allure Leather (M12375)

*Notes:
Ocean - Color 3, 21, 32, 50, 52, 80 & 601
Illusion - Black, Blue, Caribou, Chocolate, Ciel, Dark Green,
Dark Caramel, Grey, Light Grey, Mink, Matrine, Petrol,
Stone, Taupe, Tile

OSLO LOUNGE CHAIR



All Upholstery Variants

All Variants

	Pattern No.	Upholstery Grades							
		COM				CIL			
		B	C	E	R	T	U	V	W
Oslo Lounge Chair Tube Base	MOSLLCT	2,571	2,676	2,935	3,096	3,516	3,565	4,090	4,146
Oslo Lounge Chair Swivel Base	MOSLLCS	2,935	3,096	3,621	3,775	4,090	4,146	4,510	4,566

HOW TO CONFIGURE

Specify:

- Step 1: Choose variant
 Step 2: Choose base color
 Step 3: Choose textile
 Step 4: Choose textile color

ORDER CODE EXAMPLE

Oslo Lounge Chair Tube Base in Colline 227

Variant	Oslo Lounge Chair Tube base	MOSLLCT
Base Color	Black	BLCK
Textile	Colline	M5416
Textile Color	227	227
Final Pattern No:	MOSLLCTBLCKM5416227	

Base Finish Options

- BLCK - Black
 GREY - Grey

Upholstery Options

B	C	E	R	T	U	V	W
Canvas (M153) Clara (M154) Fiord (M155) Grain (M12659) Manner (M12665) Re-Wool (M4586) Sabi (M8404) Steelcut (M149) Steelcut Trio (M139)	Hallingdal (M146) Illusion (M12654)	Acca (M12660) Beck (M6376) Divina (M150) Divina MD (M147) Divina Melange (M135) Hearth (M12664) Planum (M5904) Twill Weave (M142) Vidar (M158)	Easy Leather (M141)	Refine Leather (M136)	Endure Leather (M137)	Grace Leather (M12374)	Allure Leather (M12375)

*Notes:

Illusion - Black, Blue, Caribou, Chocolate, Ciel, Dark Green,
 Dark Caramel, Grey, Light Grey, Mink, Matrine, Petrol,
 Stone, Taupe, Tile

OUTLINE SOFA SERIES

"With the Outline Sofa Family, we wanted to create a visually light and elegant design with lots of comfort, translating aspects of modern architecture into the design through juxtaposing elements. Outline is created with slim proportions for a simple and elegant look, complemented by its generous seat and slender legs. There's a calm serenity about the Outline Sofa Family, having a soft and deep seat with clean lines and a strong architectural presence, brought forth by its overlapping forms that bring a refined touch to the expression of the design."

— Anderssen & Voll

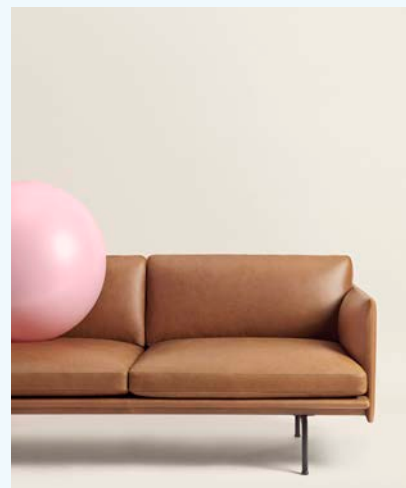

Designed by	Anderssen & Voll
Environment	Indoor
Country of Production	Lithuania or Slovakia
Assembly Required	Yes – Mount legs. Please note that the Highback Sofas 1-Seater, 2-Seater, 3-Seater, Work and Cabin are not preassembled.
Description	The Outline Sofa Family adds new perspectives to the classic Scandinavian design sofas of the 1960's, marrying the ideals of simplicity and function into one. With the design taking its name from its strong outline of a sofa, the Outline Sofa Family is clean and elegant on the outside with a deep seat and soft cushioning on its inside. The Outline Sofa Family has an expression that is at once elegant yet timeless, elevated by its lines referencing architectural shapes alongside its curved armrests, giving the design a distinct appearance across various sizes and variants.
Material	Black powder coated or polished aluminum base with pre-mounted felt glides. Wood and steel construction. Cold foam filling. Fully upholstered with textile, imitation leather or leather. Leather from selected premium leather suppliers. The table unit for the Outline Highback Cabin and Outline Highback Work is made from robust MDF board with matte laminate (black ABS edges).
Cleaning & Care	Textile: In case of stains, we generally recommend removing non-greasy stains by carefully dabbing with a lint-free cloth or sponge wrung out in clean warm water. If necessary, clean by dabbing with soapy water made with a little dish soap. Finally, dab the surface with clean water. We highly recommend that you go to kvadrat.dk for further cleaning and maintenance instructions for your chosen textile, as the cleaning methods may vary from one textile to another. Imitation Leather: Clean with lukewarm PH-neutral soapy water and a soft cloth or soft brush. Do not use solvents or chemical cleaners, but cleaning can be done with alcohol-based cleaners. Finally, wipe with a damp cloth afterwards. Leather: As a natural material, leather requires looking after. If you care for the leather in the right way, it will become even more beautiful over time. Refine Leather, Easy Leather and Endure Leather: Clean leather with a dry cloth regularly. treat the leather at least four times a year using only special leather treatment products. Visit ca-mo.com further information on cleaning leather. Allure and Grace Leather: Only vacuum clean with a soft brush. Never use soap or water otherwise the velvety look and feel will disappear. Do not apply leather grease or soak the leather. Avoid any chemical products, such as saddle soap, leather cleaners or household products. Matte Laminate: Clean the table with a damp cloth. If necessary, only use a mild detergent or washing up liquid and not concentrated. Always wipe with a dry cloth afterwards. To minimize the risk of stains and marks, liquid, grease etc. should be removed straight away. Base: Clean powder coated or polished aluminum surfaces with a lint-free cloth.

Additional Product Information

A Power Outlet including USB and USB-C charger can be added to the Outline Sofa Series. The Power Outlet is available in an EU, US and UK version. Please note that Muuto does not offer installation of the Power Outlet into any Muuto products.

- 2-Seater
- 3-Seater
- 3 ½-Seater
- Chaise Longue
- Corner Sofa
- Pouf
- Chair
- Studio Chair
- Studio Sofa 140 cm / 55.1"
- Studio Sofa 170 cm / 66.9"
- Studio Sofa 220 cm / 86.6"
- Highback 100 1-Seater
- Highback 100 2-Seater
- Highback 100 3-Seater
- Highback 120 1-Seater
- Highback 120 2-Seater
- Highback 120 3-Seater
- Highback Cabin 100 2-seater
- Highback Cabin 100 3-seater
- Highback Cabin 120 2-Seater
- Highback Cabin 120 3-Seater
- Highback Work 100
- Highback Work 120
- Daybed
- Daybed Cushion

CUSTOMIZED UPHOLSTERY

Textile upholstery: 7,9 m / 8.6 yds — Leather upholstery: 17,5 m² / 188.4 ft²
 Textile upholstery: 9 m / 9.8 yds — Leather upholstery: 20,5 m² / 220.7 ft²
 Textile upholstery: 9,4 m / 10.3 yds — Leather upholstery: 21,2 m² / 228.2 ft²
 Textile upholstery: 11,9 m / 13 yds — Leather upholstery: 25,1 m² / 270.2 ft²
 Textile upholstery: 16,5 m / 18 yds — Leather upholstery: 35,6 m² / 383.2 ft²
 Textile upholstery: 2,5 m / 2.7 yds — Leather upholstery: 5,6 m² / 60.3 ft²
 Textile upholstery: 4,8 m / 5.2 yds — Leather upholstery: 9,6 m² / 103.4 ft²
 Textile upholstery: 4,7 m / 5.1 yds — Leather upholstery: 9,4 m² / 101.2 ft²
 Textile upholstery: 6,2 m / 6.8 yds — Leather upholstery: 13,8 m² / 148.6 ft²
 Textile upholstery: 6,8 m / 7.4 yds — Leather upholstery: 14.4 m² / 155 ft²
 Textile upholstery: 8,1 m / 8.9 yds — Leather upholstery: 17,4 m² / 187.3 ft²
 Textile upholstery: 7 m / 7.7 yds — Leather upholstery: 14,2 m² / 152.85 ft²
 Textile upholstery: 10,5 m / 11.5 yds — Leather upholstery: 22,5 m² / 242.2 ft²
 Textile upholstery: 13 m / 14.2 yds — Leather upholstery: 26,5 m² / 285.3 ft²
 Textile upholstery: 7,9 m / 8.3 yds — Leather upholstery: 17,8 m² / 191.6 ft²
 Textile upholstery: 12 m / 13.1 yds — Leather upholstery: 27,6 m² / 297.1 ft²
 Textile upholstery: 14,3 m / 15.6 yds — Leather upholstery: 32,9 m² / 354.1 ft²
 Textile upholstery: 24,8 m / 27.1 yds — Leather upholstery: 53,6 m² / 576.9 ft²
 Textile upholstery: 28,9 m / 31.6 yds — Leather upholstery: 63,1 m² / 679.2 ft²
 Textile upholstery: 26,6 m / 29.1 yds — Leather upholstery: 60,6 m² / 652.3 ft²
 Textile upholstery: 30,9 m / 33.8 yds — Leather upholstery: 70,5 m² / 758.9 ft²
 Textile upholstery: 8,1 m / 8.9 yds — Leather upholstery: 15,8 m² / 170.1.2 ft²
 Textile upholstery: 8,8 m / 9.7 yds — Leather upholstery: 20 m² / 215.5 ft²
 Textile upholstery: 4,9 m / 5.4 yds — Leather upholstery: 8,6 m² / 92.6 ft²
 Textile upholstery: 1 m / 1.1 yds — Leather upholstery: 1 m² / 10.8 ft²

TESTS & CERTIFICATIONS*

- EN 1022:2005 Domestic furniture - Seating - Determination of stability.
Please note that this test does not apply to the Outline Highback 120, Highback Work 120, and Highback Cabin 120
- EN 16139:2013 - L2 Extreme use. Furniture - Strength, durability and safety.
Requirements for non-domestic seating.
- ANSI/BIFMA X5.4-2012 American National Standard for Office Furnishings - Lounge and Public Seating.
Please note that for the Outline Highback Work, only the sofa itself is Bifma-tested (not the built-in table) and therefore only has a 5-year warranty.
- ANSI/BIFMA X5.4-2020 Outline Highback 120, Highback Work 120, and Highback Cabin 120:
American National Standard for Office Furnishings - Lounge and Public Seating.
- ANSI/BIFMA X5.5 Table for Outline Highback Cabin 100 and 120:
American National Standard for Office Furnishings - Desk Products.

*Please note that none of the above mentioned tests apply to the Outline Daybed.

- Declare. EU/US versions of the Outline Sofa Series that are upholstered with a large selection of Kvadrat textiles¹ are Living Building Challenge Red List Approved as part of Muuto's participation in Declare.
- VOC CDPH 01350 & VOC BIFMA X7.1. Outline Sofa Series in EU/US versions upholstered with Easy or Refine Leather and a large selection of Kvadrat textiles¹ are tested to VOC CDPH 01350 and VOC BIFMA X7.1.

¹Upholstered Muuto products that have the Declare Living Building Challenge Red List Approved certification only have the certification when upholstered with the following Kvadrat textiles: Balder, Canvas, Clara, Clay, Divina, Divina MD, Divina mélange, Fiord, Hallingdal, Hero, Remix, Re-wool, Steelcut, Steelcut Trio, Vidar, Twill weave.

The Outline Sofa Family adds new perspectives to the classic Scandinavian design sofas of the 1960's, marrying the ideals of simplicity and function into one. With the design taking its name from its strong outline of a sofa, the Outline family is clean and elegant on the outside with a deep seat and soft cushioning on its inside.

Chair

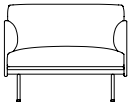

88 cm / 34.6"

2-Seater

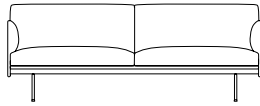

170 cm / 66.9"

3-Seater

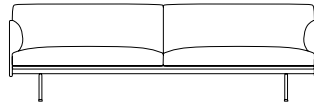

220 cm / 86.6"

3 1/2-Seater

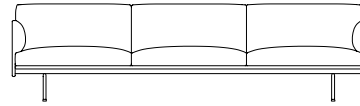

255 cm / 100.4"

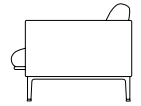

84 cm / 33.1"

71 cm / 28"
SH 40 cm / 15.7"

Chaise Longue Left



263 cm / 103.5"

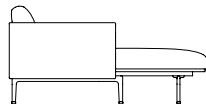

142 cm / 55.9"

71 cm / 28"
SH 40 cm / 15.7"

Chaise Longue Right

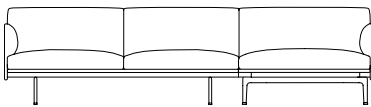

263 cm / 103.5"

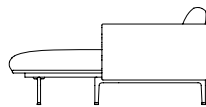

142 cm / 55.9"

71 cm / 28"
SH 40 cm / 15.7"

Corner

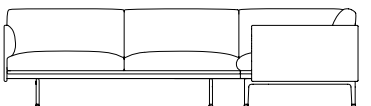

255 cm / 100.4"

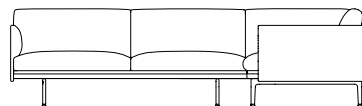

84 cm / 33.1"

71 cm / 28"
SH 40 cm / 15.7"

Pouf

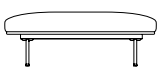

111 cm / 43.7"

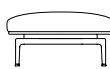

78 cm / 30.7"

40 cm / 15.7"

Daybed & Daybed Cushion



200 cm / 78.8"

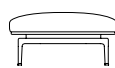

82 cm / 32.3"

40 cm / 15.7"

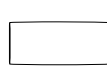

70 cm / 27.6"

40 cm / 15.7"



12 cm / 4.7"

30 cm / 11.8"

Highback I 00 (Also available with SH: 45 cm / 17.7")

1-Seater

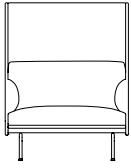

88 cm / 34.7"

2-Seater

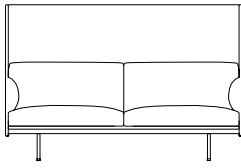

170 cm / 66.9"

3-Seater

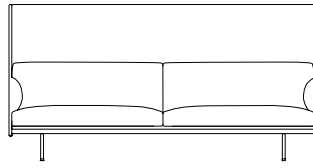

220 cm / 86.6"

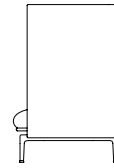

76 cm / 29.9"

115 cm / 45.3"
SH 40 cm / 15.7"

Highback I 20 (Also available with SH: 45 cm / 17.7")

1-Seater

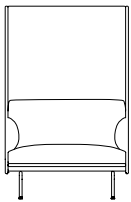

88 cm / 34.7"

2-Seater

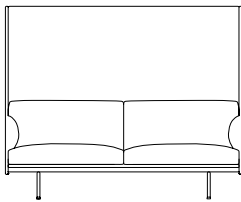

170 cm / 66.9"

3-Seater

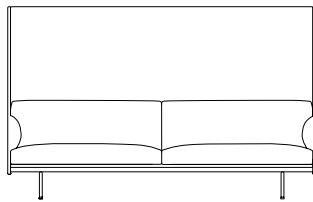

220 cm / 86.6"

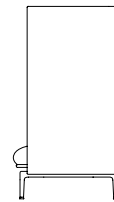

76 cm / 29.9"

140 cm / 55.12"
SH 40 cm / 15.7"

Highback Work I 00 (Also available with SH: 45 cm / 17.7")

Left

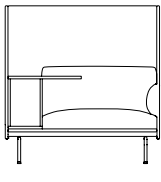

111 cm / 43.7"

Right

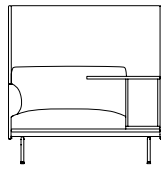

111 cm / 43.7"

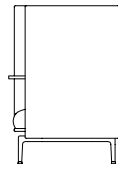

78 cm / 30.7"

115 cm / 45.3"
SH 40 cm / 15.7"

Highback Work I 20 (Also available with SH: 45 cm / 17.7")

Left

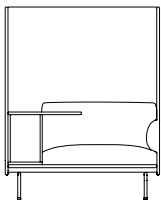

111 cm / 43.7"

Right

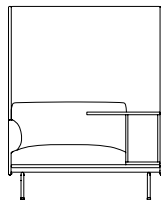

111 cm / 43.7"

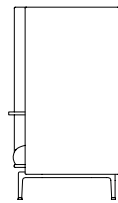

78 cm / 30.7"

140 cm / 55.12"
SH 40 cm / 15.7"

Highback Cabin I OO (Also available with SH: 45 cm / 17.7")

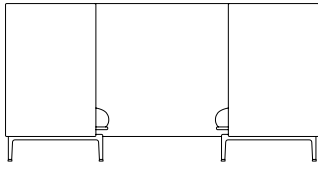

231 cm / 9Q94"

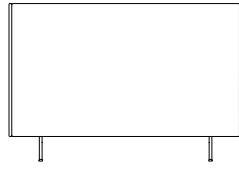

170 cm / 66.9"

115 cm / 45.3"
SH 40 cm / 15.7"

2-Seater

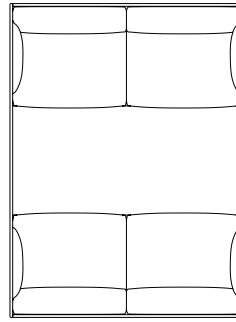

170 cm / 66.9"

3-Seater

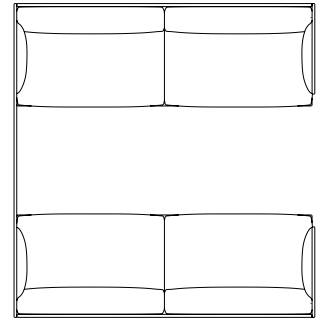

220 cm / 86.6"

Highback Cabin I 2O (Also available with SH: 45 cm / 17.7")

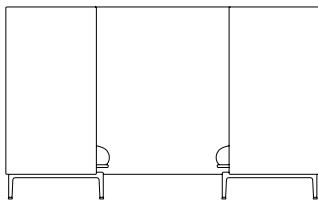

231 cm / 9Q94"

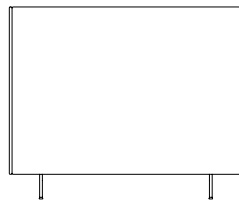

170 cm / 66.9"

140 cm / 55.1 2"
SH 40 cm / 15.7"

2-Seater

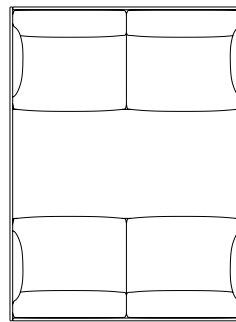

170 cm / 66.9"

3-Seater

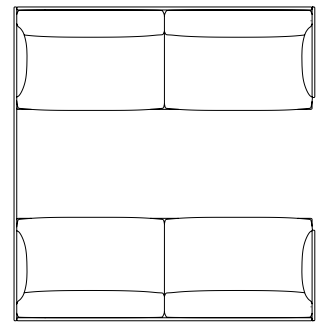

220 cm / 86.6"

Highback Cabin I OO w Table—SH45 cm

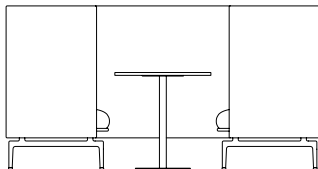

231 cm / 9Q94"
Table W 70cm / 27.56"

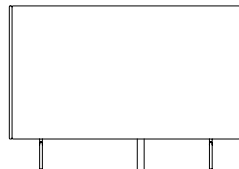

170 cm / 66.9"

120 cm / 47.3"
SH 45 cm / 17.7"

Table H 71 cm / 27.95"

2-Seater

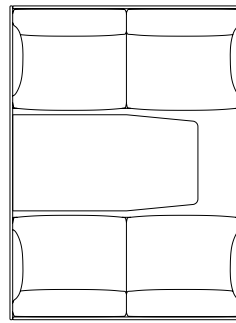

170 cm / 66.9"

Highback Cabin I 2O w Table—SH45 cm

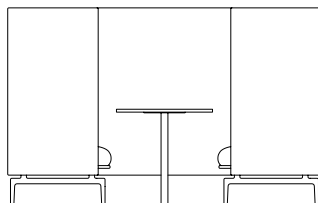

231 cm / 9Q94"
Table W 70cm / 27.56"

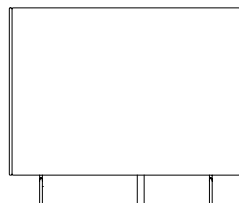

170 cm / 66.9"

145 cm / 57.09"
SH 45 cm / 17.7"

Table H 71 cm / 27.95"

2-Seater

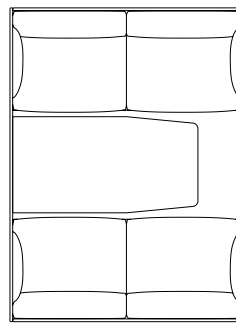

170 cm / 66.9"

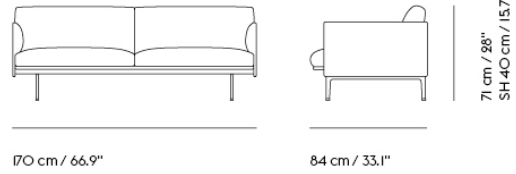

Shipper Colli 1
Gross Weight (kg) 55
Net Weight (kg) 50
Warranty Period 10 years

Pattern No.	Color	Contract Price	Lead Time
Ready-To-Ship US Warehouse			
MOUSF2-BLCK-M156163	Remix l63/Black	USD 4,405.00	-
MOUSF2-BLCK-K23401	Attire l/Black ***	USD 5,140.00	-
MOUSF2-BLCK-M136COGN	Refine Leather Cognac/Black	USD 7,240.00	-
Extras			
99904	99904		-
MLEAKIT	Leather care set for Refine Leather	USD 27.00	-
MPWROUT	Power Outlet - Black	USD 572.00	-

OUTLINE SOFA / 2-SEATER - POLISHED ALUMINUM BASE

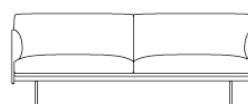

170 cm / 66.9"

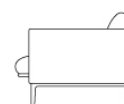

84 cm / 33.1"

71 cm / 28"
SH 40 cm / 15.7"

Shipper Colli	1
Gross Weight (kg)	55
Net Weight (kg)	50
Warranty Period	10 years

Pattern No.	Color	Contract Price	Lead Time
Ready-To-Ship US Warehouse			
MOUTSF2-ALU-M150984	Divina 984/Polished Aluminum ***	USD 5,875.00	-
Ready-To-Ship EU Warehouse			
MOUTSF2-ALU-M10767240	Ecriture 240/Polished Aluminum	USD 5,875.00	-
Extras			
99904	99904		-
MLEAKIT	Leather care set for Refine Leather	USD 27.00	-
MPWROUT	Power Outlet - Black	USD 572.00	-

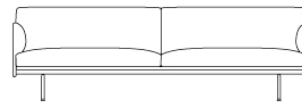

220 cm / 86.6"

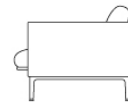

84 cm / 33.1"

71 cm / 28"
SH 40 cm / 15.7"

Shipper Colli	1
Gross Weight (kg)	74
Net Weight (kg)	69
Warranty Period	10 years

Pattern No.	Color	Contract Price	Lead Time
Ready-To-Ship US Warehouse			
MOUSF3-BLCK-M156163	Remix I63/Black	USD 4,825.00	-
MOUSF3-BLCK-K23401	Attire I/Black ***	USD 5,721.00	-
MOUSF3-BLCK-M136COGN	Refine Leather Cognac/Black	USD 8,031.00	-
Extras			
99904	99904		-
MLEAKIT	Leather care set for Refine Leather	USD 27.00	-
MPWROUT	Power Outlet - Black	USD 572.00	-

OUTLINE SOFA / 3-SEATER - POLISHED ALUMINUM BASE

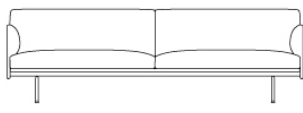

220 cm / 86.6"

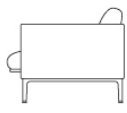

84 cm / 33.1"

71 cm / 28"
SH 40 cm / 15.7"

- Shipper Colli 1
- Gross Weight (kg) 74
- Net Weight (kg) 69
- Warranty Period 10 years

Pattern No.	Color	Contract Price	Lead Time
Ready-To-Ship US Warehouse			
MOUTSF3-ALU-M150984	Divina 984/Polished Aluminum ***	USD 6,561.00	-
Ready-To-Ship EU Warehouse			
MOUTSF3-ALU-M10767240	Ecriture 240/Polished Aluminum	USD 6,561.00	-
Extras			
99904	99904		-
MLEAKIT	Leather care set for Refine Leather	USD 27.00	-
MPWROUT	Power Outlet - Black	USD 572.00	-

VARIANTS MARKED WITH *** WILL BE MADE-TO-ORDER OR DISCONTINUED WHEN OUT OF STOCK FOR MORE INFORMATION VISIT MUUTO.COM

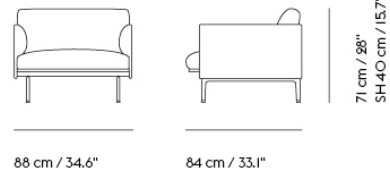

Shipper Colli 1
 Gross Weight (kg) 35
 Net Weight (kg) 30
 Warranty Period 10 years

Pattern No.	Color	Contract Price	Lead Time
Ready-To-Ship US Warehouse			
MOUTC-BLCK-M156163	Remix I63/Black	USD 3,096.00	-
MOUTC-BLCK-K23401	Attire I/Black ***	USD 3,516.00	-
MOUTC-BLCK-M136COGN	Refine Leather Cognac/Black	USD 4,671.00	-
Extras			
99904	99904		-
MLEAKIT	Leather care set for Refine Leather	USD 27.00	-
MPWR0UT	Power Outlet - Black	USD 572.00	-

OUTLINE CHAIR / POLISHED ALUMINUM BASE

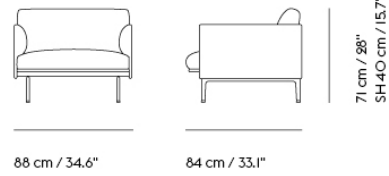

Shipper Colli 1
Gross Weight (kg) 35
Net Weight (kg) 30
Warranty Period 10 years

Pattern No.	Color	Contract Price	Lead Time
Ready-To-Ship US Warehouse			
MOUTC-ALU-M150984	Divina 984/Polished Aluminum ***	USD 4,041.00	-
Ready-To-Ship EU Warehouse			
MOUTC-ALU-M10767240	Ecriture 240/Polished Aluminum	USD 4,041.00	-
Extras			
99904	99904		-
MLEAKIT	Leather care set for Refine Leather	USD 27.00	-
MPWROUT	Power Outlet - Black	USD 572.00	-

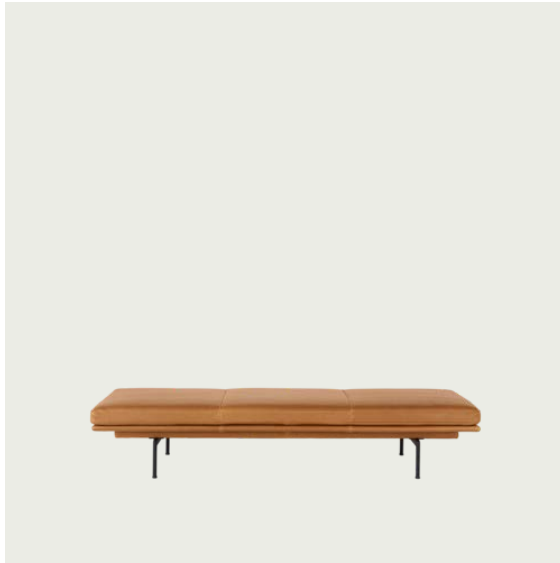

200 cm / 78.8"

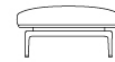

82 cm / 32.3"

40 cm / 15.7"

Shipper Colli	1
Gross Weight (kg)	50
Net Weight (kg)	40
Warranty Period	5 years

Pattern No.	Color	Contract Price	Lead Time
Ready-To-Ship EU Warehouse			
MOUJD-BLCK-M136COGN	Refine Leather Cognac/Black	USD 5,350.00	-
Extras			
99904	99904		-
MLEAKIT	Leather care set for Refine Leather	USD 27.00	-
MPWR0UT	Power Outlet - Black	USD 572.00	-



Shipper Colli 1
Gross Weight (kg) 4
Net Weight (kg) 1.35
Warranty Period 5 years

Pattern No.	Color	Contract Price	Lead Time
Ready-To-Ship EU Warehouse			
MOUTDC-M136COGN	Refine Leather Cognac	USD 629.00	-
Extras			
99904	99904		-
MLEAKIT	Leather care set for Refine Leather	USD 27.00	-

OUTLINE HIGHBACK WORK 100 / LEFT - POLISHED ALUMINUM BASE

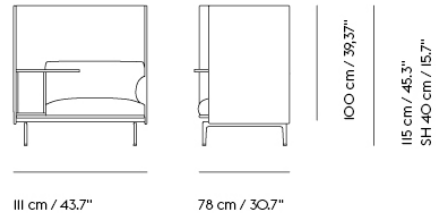

- Shipper Colli 1
- Gross Weight (kg) 83
- Net Weight (kg) 74
- Please note That this product features a table on the left-hand side when facing the product from the front.
- Warranty Period 5 years

Pattern No.	Color	Contract Price	Lead Time
-------------	-------	----------------	-----------

Ready-To-Ship US Warehouse

MOUTHBW16L-ALU-M150984	Divina 984/Polished Aluminum ***	USD 7,506.00	-
------------------------	----------------------------------	--------------	---

Extras

99904	99904		-
MLEAKIT	Leather care set for Refine Leather	USD 27.00	-
MPWROUT	Power Outlet - Black	USD 572.00	-

OUTLINE HIGHBACK WORK 100 / LEFT - BLACK BASE

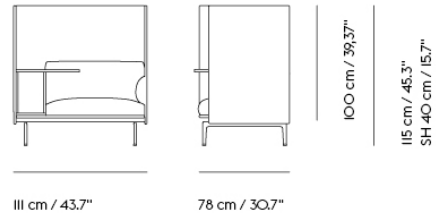

- Shipper Colli 1
- Gross Weight (kg) 83
- Net Weight (kg) 74
- Please note That this product features a table on the left-hand side when facing the product from the front.
- Warranty Period 5 years

Pattern No.	Color	Contract Price	Lead Time
Ready-To-Ship US Warehouse			
MOUTHBW16L-BLCK-M156163	Remix 163/Black	USD 5,980.00	-
Extras			
99904	99904		-
MLEAKIT	Leather care set for Refine Leather	USD 27.00	-
MPWROUT	Power Outlet - Black	USD 572.00	-

OUTLINE HIGHBACK WORK 100 / RIGHT - BLACK BASE

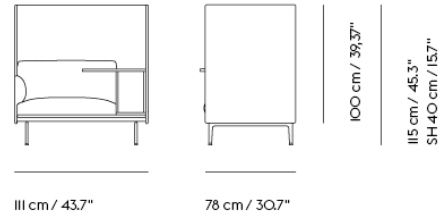

Shipper Colli 1
Gross Weight (kg) 83
Net Weight (kg) 74
Please note That this product features a table on the right-hand side when facing the product from the front.
Warranty Period 5 years

Pattern No.	Color	Contract Price	Lead Time
Ready-To-Ship US Warehouse			
MOUTHBW16R-BLCK-M156163	Remix 163/Black	USD 5,980.00	-
Extras			
99904	99904		-
MLEAKIT	Leather care set for Refine Leather	USD 27.00	-
MPWROUT	Power Outlet - Black	USD 572.00	-

OUTLINE HIGHBACK WORK 100 / RIGHT - POLISHED ALUMINUM BASE

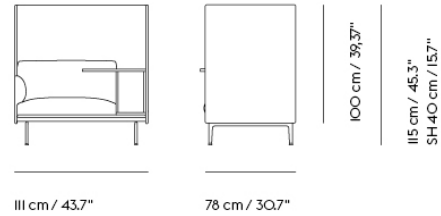

- Shipper Colli 1
- Gross Weight (kg) 83
- Net Weight (kg) 74
- Please note That this product features a table on the right-hand side when facing the product from the front.
- Warranty Period 5 years

Pattern No.	Color	Contract Price	Lead Time
-------------	-------	----------------	-----------

Ready-To-Ship US Warehouse

MOUTHBW16R-ALU-M150984	Divina 984/Polished Aluminum	USD 7,506.00	-
------------------------	------------------------------	--------------	---

Extras

99904	99904		-
MLEAKIT	Leather care set for Refine Leather	USD 27.00	-
MPWROUT	Power Outlet - Black	USD 572.00	-

OUTLINE HIGHBACK SOFA 100 / 1-SEATER - BLACK BASE

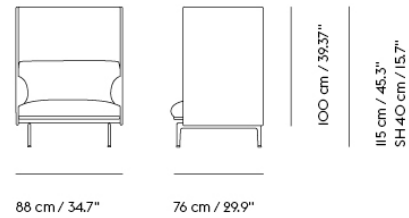

Shipper Colli	1
Gross Weight (kg)	63
Net Weight (kg)	54
Additional Information	Please note that the highback height for this product is 100 cm / 39.4"
Warranty Period	10 years

Pattern No.	Color	Contract Price	Lead Time
Ready-To-Ship US Warehouse			
MOUTHBSF116-BLCK-M156163	Remix 163/Black	USD 4,090.00	-
MOUTHBSF116-BLCK-K23401	Attire 1/Black ***	USD 4,671.00	-
Extras			
99904	99904		-
MLEAKIT	Leather care set for Refine Leather	USD 27.00	-
MPWROUT	Power Outlet - Black	USD 572.00	-

OUTLINE HIGHBACK SOFA 100 / 1-SEATER - POLISHED ALUMINUM BASE

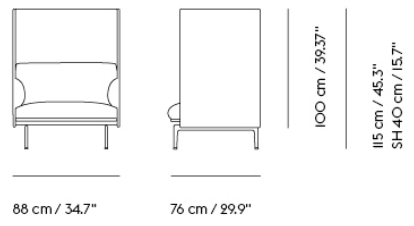

Shipper Colli	1
Gross Weight (kg)	63
Net Weight (kg)	54
Additional Information	Please note that the highback height for this product is 100 cm / 39.4"
Warranty Period	10 years

Pattern No.	Color	Contract Price	Lead Time
Ready-To-Ship US Warehouse			
MOUTHBSF116-ALU-M150984	Divina 984/Polished Aluminum	USD 5,616.00	-
Extras			
99904	99904		-
MLEAKIT	Leather care set for Refine Leather	USD 27.00	-
MPWROUT	Power Outlet - Black	USD 572.00	-

OUTLINE HIGHBACK SOFA 100 / 2-SEATER - BLACK BASE

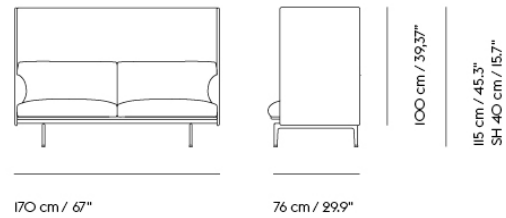

Shipper Colli	1
Gross Weight (kg)	71.6
Net Weight (kg)	71.6
Additional Information	Please note that the highback height for this product is 100 cm / 39.4"
Warranty Period	10 years

Pattern No.	Color	Contract Price	Lead Time
Ready-To-Ship US Warehouse			
MOUTHBSF216-BLCK-M156163	Remix 163/Black	USD 5,511.00	-
MOUTHBSF216-BLCK-K23401	Attire 1/Black ***	USD 6,141.00	-
Extras			
99904	99904		-
MLEAKIT	Leather care set for Refine Leather	USD 27.00	-
MPWROUT	Power Outlet - Black	USD 572.00	-

OUTLINE HIGHBACK SOFA 100 / 2-SEATER - POLISHED ALUMINUM BASE

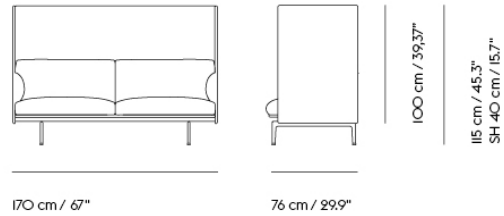

Shipper Colli	1
Gross Weight (kg)	85.84
Net Weight (kg)	71.6
Additional Information	Please note that the highback height for this product is 100 cm / 39.4"
Warranty Period	10 years

Pattern No.	Color	Contract Price	Lead Time
-------------	-------	----------------	-----------

Ready-To-Ship US Warehouse

MOUTHBSF216-ALU-M150984	Divina 984/Polished Aluminum	USD 7,296.00	-
-------------------------	------------------------------	--------------	---

Extras

99904	99904		-
MLEAKIT	Leather care set for Refine Leather	USD 27.00	-
MPWROUT	Power Outlet - Black	USD 572.00	-

OUTLINE SOFA SERIES 1/2



All Variants

	Pattern No.	Base Color	Upholstery Grades									
			A	B	C	E	G	R	T	U	V	W
Outline Chair	M-OUT-C-BLCK	black	3,096	3,516	3,621	3,775	4,090	4,146	4,671	5,616	5,721	6,085
	M-OUT-C-ALU	aluminum	3,355	3,775	3,880	4,041	4,356	4,405	4,986	5,875	5,980	6,351
Outline 2-seater	M-OUT-SF-2-BLCK	black	4,405	5,140	5,406	5,616	5,875	6,876	7,240	8,920	9,081	9,816
	M-OUT-SF-2-ALU	aluminum	4,671	5,406	5,721	5,875	6,141	7,191	7,506	9,186	9,340	10,131
Outline 3-seater	M-OUT-SF-3-BLCK	black	4,825	5,721	5,980	6,295	6,561	7,450	8,031	10,180	10,446	11,545
	M-OUT-SF-3-ALU	aluminum	5,091	5,980	6,246	6,561	6,820	7,765	8,290	10,446	11,020	11,545
Outline 3.5-seater	M-OUT-SF-35-BLCK	black	5,511	6,141	6,876	7,030	7,296	8,920	9,340	12,070	12,070	12,595
	M-OUT-SF-35-ALU	aluminum	5,770	6,456	7,191	7,296	7,555	9,186	9,606	12,595	12,595	13,120
Outline Daybed	M-OUT-D-BLCK	black	3,306	3,775	4,041	4,090	4,356	4,405	5,350	5,980	6,141	6,351
	M-OUT-D-ALU	aluminum	3,565	4,041	4,300	4,356	4,615	4,671	5,616	6,246	6,456	6,610
Outline Daybed cushion	M-OUT-DC		450	520	576	597	614	614	629	719	776	807

HOW TO CONFIGURE

Specify:

- Step 1) Choose Variant + base color
- Step 2) Upholstery option
- Step 3) Upholstery color

ORDER CODE EXAMPLE:

Outline 2-seater sofa in Ocean 80 w/black base

Variant + base color Outline 2-seater sofa MOUTSF2-BLCK
 Upholstery option Ocean M161
 Upholstery Color 80
 Final Pattern No: MOUTSF2BLCKM16180

Base Finish Options

- BLCK - Black
- ALU - Aluminum

Upholstery Options

A	B	C	E	G	R	T	U	V	W
Mode (M2319) Ocean (M161)* Remix (M156)	Cameo (K1443) Canvas (M153) Clara (M154) Colline (M4516) Fiord (M155) Grain (M12659) Manner (M12665) Pebble Weave (M6374) ** Pecora (M6372) *** Prairie (K1925)* Steelcut (M149) Steelcut Trio (M139) Steelcut Quartet (M13042)	Chameleon (K2372) Color Field (K2226) Hallingdal (M146) Illusion (M12654)	Acca (M12660) Aegean (K2074) Balder (M152) Beck (M6376) Divina (M150) Divina MD (M147) Divina Melange (M135) Ecriture (M10767) Hearth (M12664) Premiere (K2294) Twill Weave (M142) Vidar (M158)	Modern Tweed (K2155)	Easy Leather (M141)	Refine Leather (M136)	Endure Leather (M137)	Grace Leather (M12374)	Allure Leather (M12375)

*Notes:
 *Ocean: Color 3, 21, 32, 50, 52, 80 & 601
 Pebble Weave: Color 3, 7, 8, 11, 12, 21
 Pecora: Color 6049, 6083, 6084, 6093, 60112
 *Prairie: All Additive Free (ADF) Colors
 Illusion - Black, Blue, Caribou, Chocolate, Ciel,
 Dark Green, Dark Caramel, Grey, Light Grey, Mink,
 Matrine, Petrol, Stone, Taupe, Tile

OUTLINE SOFA SERIES 2/2

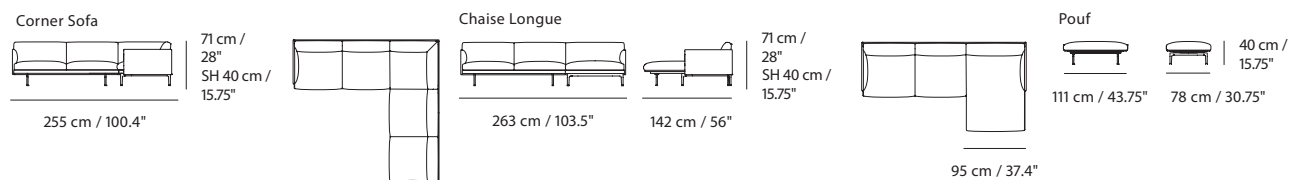

Outline Corner:
Shipper Colli 2
Gross Weight (kg) 122
Net Weight (kg) 112
Warranty Period 10 years

Outline Chaise Longue:
Shipper Colli 2
Gross Weight (kg) 90
Net Weight (kg) 80
Directional modules
Warranty Period 10 years

Right and left refers to the side when facing the product from the front.

Outline Pouf:
Shipper Colli 1
Gross Weight (kg) 23
Net Weight (kg) 17
Warranty Period 10 years

All Variants

	Pattern No.	Base Color	Upholstery Grades									
			A	B	C	E	G	R	T	U	V	W
Outline Corner sofa	M-OUT-CS-BLCK	black	8,556	9,970	11,020	11,545	11,545	14,170	15,745	18,895	20,995	22,045
	M-OUT-CS-ALU	aluminum	9,081	10,495	11,545	12,070	12,070	14,695	16,270	19,420	21,520	23,095
Outline Chaise lounge - left	M-OUT-CL-L-BLCK	black	7,030	7,555	8,500	8,920	9,340	10,446	11,020	13,645	14,695	16,270
	M-OUT-CL-L-ALU	aluminum	7,450	7,975	8,920	9,291	9,760	11,020	11,545	14,170	15,745	16,270
Outline Chaise lounge - right	M-OUT-CL-R-BLCK	black	7,030	7,555	8,500	8,920	9,340	10,446	11,020	13,645	14,695	16,270
	M-OUT-CL-R-ALU	aluminum	7,450	7,975	8,920	9,291	9,760	11,020	11,545	14,170	15,745	16,270
Outline Pouf	M-OUT-P-BLCK	black	1,570	1,836	2,095	2,515	2,571	2,620	2,571	3,306	3,355	3,621
	M-OUT-P-ALU	aluminum	1,836	2,095	2,361	2,781	2,830	2,886	2,830	3,565	3,621	3,880

HOW TO CONFIGURE

Specify:

Step 1) Choose Variant + base color
Step 2) Upholstery option
Step 3) Upholstery color

ORDER CODE EXAMPLE:

Outline 2-seater sofa in Ocean 80 w/black base

Variant + base color	Outline 2-seater sofa	MOUTSF2-BLCK
Upholstery option	Ocean	M161
Upholstery Color	80	80
Final Pattern No:	MOUTSF2BLCKM16180	

Base Finish Options

BLCK - Black
ALU - Aluminum

Upholstery Options

A	B	C	E	G	R	T	U	V	W
Mode (M2319) Ocean (M161)* Remix (M156)	Cameo (K1443) Canvas (M153) Clara (M154) Colline (M4516) Fiord (M155) Grain (M12659) Manner (M12665) Pebble Weave (M6374) ** Pecora (M6372) ** Prairie (K1925)* Steelcut (M149) Steelcut Trio (M139) *** Steelcut Quartet (M13042) ***	Chameleon (K2372) Color Field (K2226) Hallingdal (M146) Illusion (M12654)	Acca (M12660) Aegean (K2074) Balder (M152) Beck (M6376) Divina (M150) Divina MD (M147) Divina Melange (M135) Ecriture (M10767) Hearth (M12664) Premiere (K2294) Twill Weave (M142) Vidar (M158)	Modern Tweed (K2155)	Easy Leather (M141)	Refine Leather (M136)	Endure Leather (M137)	Grace Leather (M12374)	Allure Leather (M12375)

*Notes:

**Ocean: Color 3, 21, 32, 50, 52, 80 & 601

**Pebble Weave: Color 3, 7, 8, 11, 12, 21

**Pecora: Color 6049, 6083, 6084, 6093, 60112

*Prairie: All Additive Free (ADF) Colors

*** Not available on the Outline Corner Sofa or Chaise

Illusion - Black, Blue, Caribou, Chocolate, Ciel, Dark Green, Dark Caramel, Grey, Light Grey, Mink, Matrine, Petrol, Stone, Taupe, Tile

OUTLINE STUDIO SOFA SERIES



140 cm / 55.1" - both heights:
 Shipper Colli 1
 Gross Weight (kg) 41
 Net Weight (kg) 36
 Warranty Period 10 years

170 cm / 66.9" - both heights:
 Shipper Colli 1
 Gross Weight (kg) 64
 Net Weight (kg) 50
 Warranty Period 10 years

220 cm / 86.6" - both heights:
 Shipper Colli 1
 Gross Weight (kg) 70
 Net Weight (kg) 66
 Warranty Period 10 years

All Variants

STUDIO SOFA 220 CM / 86.6"

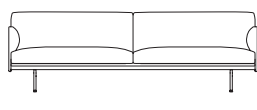

W 220 cm / 86.6"
 SW 200 cm / 78.7"

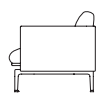

76 cm / 29.9"
 SD 54 cm / 21.3"

71 cm / 28"
 SH 40 cm / 15.7"

STUDIO SOFA 220 CM / 86.6" — SH 45 CM / 17.7"

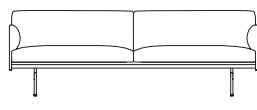

W 220 cm / 86.6"
 SW 200 cm / 78.7"

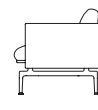

76 cm / 29.9"
 SD 54 cm / 21.3"

76 cm / 29.9"
 SH 45 cm / 17.7"

STUDIO SOFA 170 CM / 66.9"

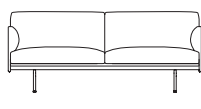

W 170 cm / 66.9"
 SW 150 / 59.1"

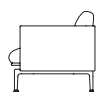

76 cm / 29.9"
 SD 54 cm / 21.3"

71 cm / 28"
 SH 40 cm / 15.7"

STUDIO SOFA 170 CM / 66.9" — SH 45 CM / 17.7"

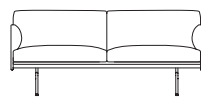

W 170 cm / 66.9"
 SW 150 / 59.1"

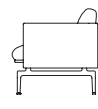

76 cm / 29.9"
 SD 54 cm / 21.3"

76 cm / 29.9"
 SH 45 cm / 17.7"

STUDIO SOFA 140 CM / 55.1"

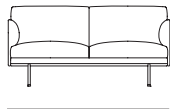

W 140 cm / 55.1"
 SW 120 cm / 47.2"

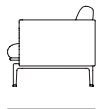

76 cm / 29.9"
 SD 54 cm / 21.3"

71 cm / 28"
 SH 40 cm / 15.75"

STUDIO 140 CM / 55.1" — SH 45 CM / 17.7"

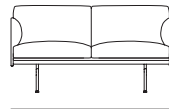

W 140 cm / 55.1"
 SW 120 cm / 47.2"



76 cm / 29.9"
 SD 54 cm / 21.3"

76 cm / 29.9"
 SH 45 cm / 17.7"

STUDIO CHAIR

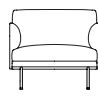

W 78 cm / 30.7"
 SW 60 cm / 23.6"

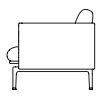

76 cm / 29.9"
 SD 54 cm / 21.3"

STUDIO CHAIR — SH 45 CM / 17.7"



W 78 cm / 30.7"
 SW 60 cm / 23.6"

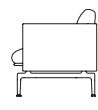

76 cm / 29.9"
 SD 54 cm / 21.3"

76 cm / 29.9"
 SH 45 cm / 17.7"

OUTLINE STUDIO SOFA SERIES

All Variants

Pattern No.	Seat Height	Base Color	Upholstery Grades									
			A	B	C	E	G	R	COL			
Outline Studio 140 cm / 55" Sofa												
M-OUT-SS-16-55-BLCK	15.75"	black	3,831	4,615	4,986	5,140	5,406	5,616	6,246	7,975	8,080	8,290
M-OUT-SS-18-55-BLCK	17.75"	black	3,831	4,615	4,986	5,140	5,406	5,616	6,246	7,975	8,080	8,290
M-OUT-SS-16-55-ALU	15.75"	aluminum	4,090	4,881	5,245	5,406	5,721	5,875	6,505	8,241	8,346	8,556
M-OUT-SS-18-55-ALU	17.75"	aluminum	4,090	4,881	5,245	5,406	5,721	5,875	6,505	8,241	8,346	8,556
Outline Studio 170 cm / 67" Sofa												
M-OUT-SS-16-67-BLCK	15.75"	black	4,090	4,671	5,091	5,350	5,511	6,295	7,240	8,500	8,661	9,291
M-OUT-SS-18-67-BLCK	17.75"	black	4,090	4,671	5,091	5,350	5,511	6,295	7,240	8,500	8,661	9,291
M-OUT-SS-16-67-ALU	15.75"	aluminum	4,356	4,986	5,350	5,616	5,770	6,561	7,506	8,766	8,920	9,550
M-OUT-SS-18-67-ALU	17.75"	aluminum	4,356	4,986	5,350	5,616	5,770	6,561	7,506	8,766	8,920	9,550
Outline Studio 220 cm / 86.5" Sofa												
M-OUT-SS-16-87-BLCK	15.75"	black	4,405	5,245	5,511	5,770	6,141	7,030	8,080	9,550	9,921	11,020
M-OUT-SS-18-87-BLCK	17.75"	black	4,405	5,245	5,511	5,770	6,141	7,030	8,080	9,550	9,921	11,020
M-OUT-SS-16-87-ALU	15.75"	aluminum	4,671	5,511	5,770	6,036	6,456	7,296	8,346	9,816	10,180	11,545
M-OUT-SS-18-87-ALU	17.75"	aluminum	4,671	5,511	5,770	6,036	6,456	7,296	8,346	9,816	10,180	11,545
Outline Studio Chair												
M-OUT-SC-16-BLCK	15.75"	black	2,620	3,096	3,516	3,565	3,775	4,090	4,300	5,140	5,350	5,721
M-OUT-SC-18-BLCK	17.75"	black	2,620	3,096	3,516	3,565	3,775	3,831	4,300	5,140	5,350	5,721
M-OUT-SC-16-ALU	15.75"	aluminum	2,886	3,355	3,775	3,831	4,041	4,146	4,566	5,406	5,616	5,980
M-OUT-SC-18-ALU	17.75"	aluminum	2,886	3,355	3,775	3,831	4,041	4,090	4,566	5,406	5,616	5,980

HOW TO CONFIGURE

ORDER CODE EXAMPLE:

Specify:

Outline Studio 140 cm Seat Height 15.75" w/black base in Ocean 80

- Step 1) Choose Variant + base color
- Step 2) Upholstery option
- Step 3) Upholstery color

Variant + base color: Outline Studio 140 cm Seat Height 15.75" w/black base
 Upholstery option: Ocean
 Upholstery Color: 80
 Final Pattern No: MOUTSF2BLCKM16180

Base Finish Options

- BLCK - Black
- ALU - Aluminum

Upholstery Options

A	B	C	E	G	R	T	U	V	W
Mode (M2319) Ocean (M161)* Remix (M156)	Cameo (K1443) Canvas (M153) Clara (M154) Colline (M4516) Fiord (M155) Grain (M12659) Manner (M12665) Pebble Weave (M6374) ** Pecora (M6372) ** Prairie (K1925)* Steelcut (M149) Steelcut Trio (M139) Steelcut Quartet (M13042)	Chameleon (K2372) Color Field (K2226) Hallingdal (M146) Illusion (M12654)	Acca (M12660) Aegean (K2074) Balder (M152) Beck (M6376) Divina (M150) Divina MD (M147) Divina Melange (M135) Ecriture (M10767) Hearth (M12664) Premiere (K2294) Twill Weave (M142) Vidar (M158)	Modern Tweed (K2155)	Easy Leather (M141)	Refine Leather (M136)	Endure Leather (M137)	Grace Leather (M12374)	Allure Leather (M12375)

*Notes:
 *Ocean: Color 3, 21, 32, 50, 52, 80 & 601
 **Pebble Weave: Color 3, 7, 8, 11, 12, 21
 ***Pecora: Color 6049, 6083, 6084, 6093, 60112
 *Prairie: All Additive Free (ADF) Colors
 Illusion - Black, Blue, Caribou, Chocolate, Ciel, Dark Green, Dark Caramel, Grey, Light Grey, Mink, Matrine, Petrol, Stone, Taupe, Tile

OUTLINE HIGHBACK SOFA SERIES 120CM



Highback Sofa 120 1-seater
 Shipper Colli: 1
 Gross Weight (kg): 35
 Net Weight (kg): 25
 Warranty Period: 10 years

Highback Sofa 120 2-seater
 Shipper Colli: 1
 Gross Weight (kg): 54
 Net Weight (kg): 38
 Warranty Period: 10 years

Highback Work 120
 Shipper Colli: 1
 Gross Weight (kg): 38
 Net Weight (kg): 28
 Warranty Period: 5 years

All Variants

HIGHBACK 3-SEATER 120CM

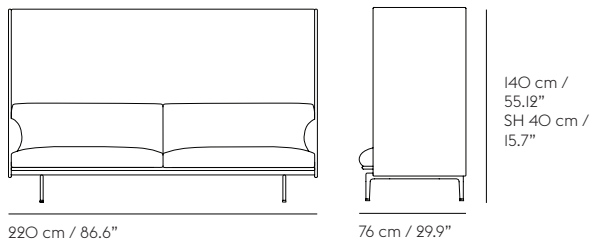

HIGHBACK 3-SEATER 120CM - SH 45CM

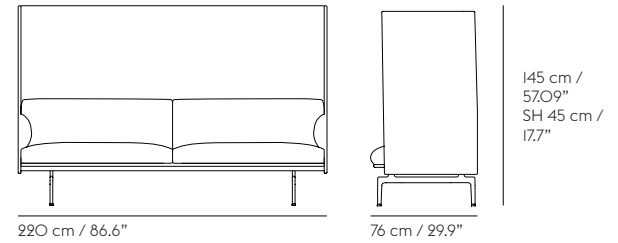

HIGHBACK 2-SEATER 120CM

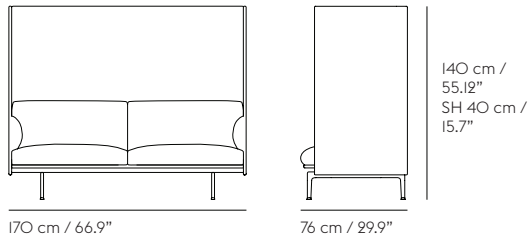

HIGHBACK 2-SEATER 120CM - SH 45CM

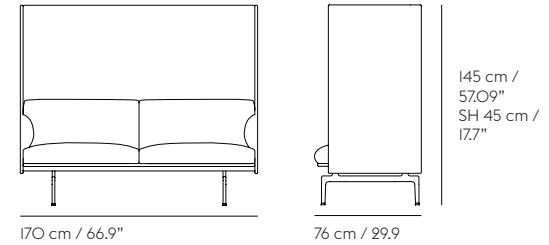

HIGHBACK WORK 120CM - RIGHT

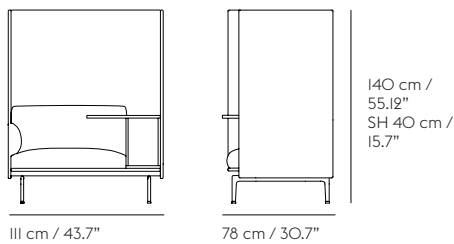

HIGHBACK WORK 120CM - SH 45CM - RIGHT

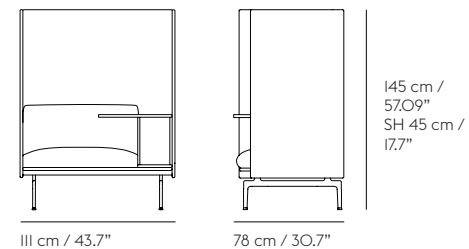

HIGHBACK 1-SEATER 120CM

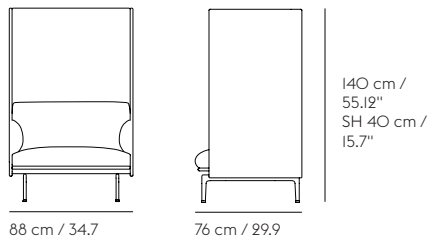

HIGHBACK 1-SEATER 120CM - SH 45CM

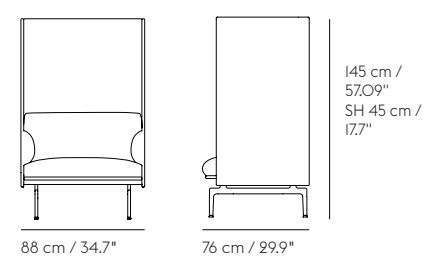

OUTLINE HIGHBACK I-SEATER & WORK

All Variants

				Upholstery Grades									
				COM			CIL			COL			
Pattern No.				A	B	C	E	G	R	T	U	V	W
		Seat Height	Base Color										
Outline Highback 1-seater- 100cm	M-OUT-HBSF-1-16-BLCK	15.75"	black	4,090	4,671	5,091	5,350	5,511	6,295	7,240	8,500	8,661	8,920
	M-OUT-HBSF-1-18-BLCK	17.75"	black	4,090	4,671	5,091	5,350	5,511	6,295	7,240	8,500	8,661	8,920
	M-OUT-HBSF-1-16-ALU	15.75"	aluminum	4,356	4,986	5,350	5,616	5,770	6,561	7,506	8,766	8,920	9,186
	M-OUT-HBSF-1-18-ALU	17.75"	aluminum	4,356	4,986	5,350	5,616	5,770	6,561	7,506	8,766	8,920	9,186
Outline Highback 1-Seater - 120cm	M-OUT-HBSF-1-16-120-BLCK	15.75"	black	4,146	4,671	4,986	5,091		6,715	7,555	8,920	9,081	9,711
	M-OUT-HBSF-1-18-120-BLCK	17.75"	black	4,146	4,671	4,986	5,091		6,715	7,555	8,920	9,081	9,711
	M-OUT-HBSF-1-16-120-ALU	15.75"	aluminum	4,405	4,986	5,245	5,350		6,981	7,821	9,186	9,340	9,970
	M-OUT-HBSF-1-18-120-ALU	17.75"	aluminum	4,405	4,986	5,245	5,350		6,981	7,821	9,186	9,340	9,970
Outline Highback Work - Left - 100cm	M-OUT-HBW-16-L-BLCK	15.75"	black	5,980	6,561	7,030	7,240	7,506	9,186	10,446	11,545	11,545	12,070
	M-OUT-HBW-18-L-BLCK	17.75"	black	5,980	6,561	7,030	7,240	7,506	9,186	10,446	11,545	11,545	12,070
	M-OUT-HBW-16-L-ALU	15.75"	aluminum	6,246	6,820	7,296	7,506	7,765	9,445	11,020	12,070	12,070	12,595
	M-OUT-HBW-18-L-ALU	17.75"	aluminum	6,246	6,820	7,296	7,506	7,765	9,445	11,020	12,070	12,070	12,595
Outline Highback Work - Left - 120cm	M-OUT-HBW-16-L-120-BLCK	15.75"	black	6,246	6,820	7,191	7,296		9,081	10,075	12,070	12,070	12,595
	M-OUT-HBW-18-L-120-BLCK	17.75"	black	6,246	6,820	7,191	7,296		9,081	10,075	12,070	12,070	12,595
	M-OUT-HBW-16-L-120-ALU	15.75"	aluminum	6,505	7,086	7,450	7,555		9,340	10,341	12,070	12,595	13,120
	M-OUT-HBW-18-L-120-ALU	17.75"	aluminum	6,505	7,086	7,450	7,555		9,340	10,341	12,070	12,595	13,120
Outline Highback Work - Right - 100cm	M-OUT-HBW-16-R-BLCK	15.75"	black	5,980	6,561	7,030	7,240	7,506	9,186	10,446	11,545	11,545	12,070
	M-OUT-HBW-18-R-BLCK	17.75"	black	5,980	6,561	7,030	7,240	7,506	9,186	10,446	11,545	11,545	12,070
	M-OUT-HBW-16-R-ALU	15.75"	aluminum	6,246	6,820	7,296	7,506	7,765	9,445	11,020	12,070	12,070	12,595
	M-OUT-HBW-18-R-ALU	17.75"	aluminum	6,246	6,820	7,296	7,506	7,765	9,445	11,020	12,070	12,070	12,595
Outline Highback Work - Right - 120cm	M-OUT-HBW-16-R-120-BLCK	15.75"	black	6,246	6,715	7,191	7,296		9,081	10,075	12,070	12,070	12,595
	M-OUT-HBW-18-R-120-BLCK	17.75"	black	6,246	6,820	7,191	7,296		9,081	10,075	12,070	12,070	12,595
	M-OUT-HBW-16-R-120-ALU	15.75"	aluminum	6,505	7,086	7,450	7,555		9,340	10,341	12,070	12,595	13,120
	M-OUT-HBW-18-R-120-ALU	17.75"	aluminum	6,505	7,086	7,450	7,555		9,340	10,341	12,070	12,595	13,120

HOW TO CONFIGURE

ORDER CODE EXAMPLE:

Specify:

Outline Highback Sofa 2-seater H 15.75" in Ocean 80 w/black legs

SStep 1) Choose Variant + base color

Variant + base color 2-seater, 15.75" SH - black base

M-OUT-HBSF-2-16-BLCK

Step 2) Upholstery option

Upholstery option Ocean

M161

Step 3) Upholstery color

Upholstery Color 80

80

Final Pattern No: MOUTHBSF216BLCKM16180

Base Finish Options

BLCK - Black

ALU - Aluminum

Upholstery Options

A	B	C	E	G	R	T	U	V	W
Mode (M2319)	Cameo (K1443)	Chameleon (K2372)	Acca (M12660)	Modern Tweed (K2155)**	Easy Leather (M141)	Refine Leather (M136)	Endure Leather (M137)	Grace Leather (M12374)	Allure Leather (M12375)
Ocean (M161)*	Canvas (M153)	Color Field (K2226)	Aegean (K2074)						
Remix (M156)	Clara (M154)	Hallingdal (M146)	Balder (M152)						
	Colline (M4516)	Illusion (M12654)	Beck (M6376)						
	Fiord (M155)		Divina (M150)						
	Grain (M12659)		Divina MD (M147)						
	Manner (M12665)		Divina Melange (M135)						
	Pebble Weave (M6374)*		Ecriture (M10767)						
	Pecora (M6372)*		Hearth (M12664)						
	Prairie (K1925)		Premiere (K2294)						
	Steelcut Trio (M139)		Twill Weave (M142)						
	Steelcut Quartet (M13042)		Vidar (M158)						

*Notes:

*Ocean: Color 3, 21, 32, 50, 52, 80 & 601

Pebble Weave: Color 3, 7, 8, 11, 12, 21

Pecora: Color 6049, 6083, 6084, 6093, 60112

*Prairie: All Additive Free (ADF) Colors

**Textiles are not available on the 120cm variants

Illusion - Black, Blue, Caribou, Chocolate, Ciel, Dark Green, Dark Caramel, Grey, Light Grey, Mink, Matrine, Petrol, Stone, Taupe, Tile

OUTLINE HIGHBACK SOFA SERIES



3-seater - both heights:

Shipper Colli	1
Gross Weight (kg)	75
Net Weight (kg)	69
Warranty Period	10 years

2-seater - both heights:

Shipper Colli	1
Gross Weight (kg)	70
Net Weight (kg)	66
Warranty Period	10 years

1-seater - both heights:

Shipper Colli	1
Gross Weight (kg)	63
Net Weight (kg)	54
Warranty Period	10 years

Outline Highback Work - all versions:

Shipper Colli	1
Gross Weight (kg)	83
Net Weight (kg)	74
Warranty Period	5 years

All Variants

HIGHBACK 3-SEATER

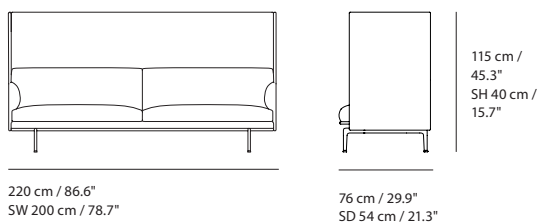

HIGHBACK 3-SEATER — SH 45 CM / 17.7"

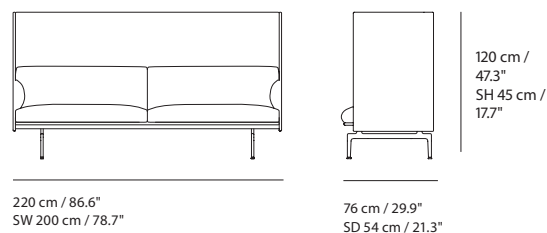

HIGHBACK 2-SEATER

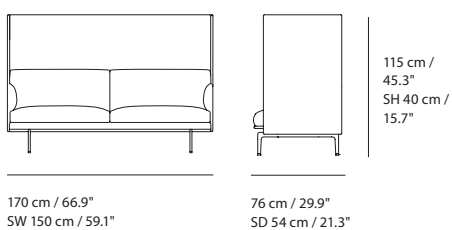

HIGHBACK 2-SEATER — SH 45 CM / 17.7"

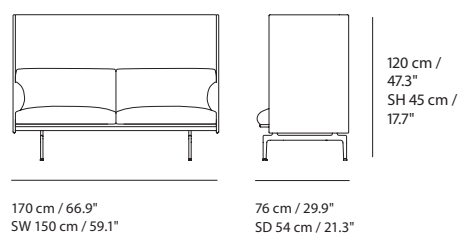

HIGHBACK WORK

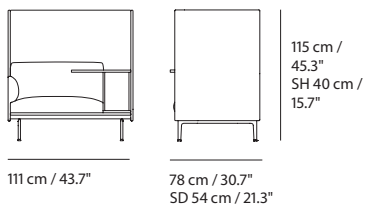

HIGHBACK WORK — SH 45 CM / 17.7"

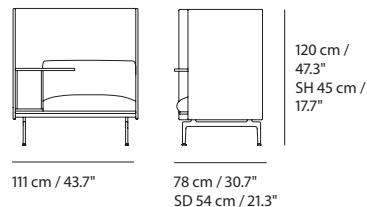

HIGHBACK 1-SEATER

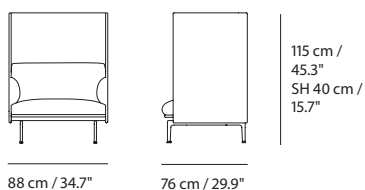

HIGHBACK 1-SEATER — SH 45 CM / 17.7"

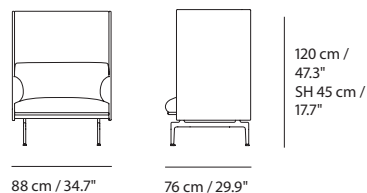

All Variants

				Upholstery Grades									
				COM		CIL			COL				
Pattern No.				A	B	C	E	G	R	T	U	V	W
		Seat Height	Base Color/ hardware										
Outline Highback Sofa	M-OUT-HBSF-2-16-BLCK	15.75"	black	5,511	6,141	6,876	7,030	7,296	8,920	9,970	11,545	12,595	13,645
2-seater - 100cm	M-OUT-HBSF-2-18-BLCK	17.75"	black	5,511	6,141	6,876	7,030	7,296	8,920	9,970	11,545	12,595	13,645
	M-OUT-HBSF-2-16-ALU	15.75"	aluminum	5,770	6,456	7,191	7,296	7,555	9,186	10,236	11,545	12,595	14,170
	M-OUT-HBSF-2-18-ALU	17.75"	aluminum	5,770	6,456	7,191	7,296	7,555	9,186	10,236	11,545	12,595	14,170
Outline Highback Sofa	M-OUT-HBSF-2-16-120-BLCK	15.75"	black	5,875	6,715	7,030	7,240		9,711	11,545	13,645	13,645	14,695
2-seater - 120cm	M-OUT-HBSF-2-18-120-BLCK	17.75"	black	5,875	6,715	7,030	7,240		9,711	11,545	13,645	13,645	14,695
	M-OUT-HBSF-2-16-120-ALU	15.75"	aluminum	6,141	6,981	7,296	7,506		9,970	11,545	13,645	14,170	14,695
	M-OUT-HBSF-2-18-120-ALU	17.75"	aluminum	6,141	6,981	7,296	7,506		9,970	11,545	13,645	14,170	14,695
Outline Highback Sofa	M-OUT-HBSF-3-16-BLCK	15.75"	black	6,295	7,030	7,450	7,975	8,241	9,970	12,070	12,595	14,695	16,270
3-seater - 100cm	M-OUT-HBSF-3-18-BLCK	17.75"	black	6,295	7,030	7,450	7,975	8,241	9,970	12,070	12,595	14,695	16,270
	M-OUT-HBSF-3-16-ALU	15.75"	aluminum	6,561	7,296	7,716	8,241	8,500	10,236	12,070	13,120	14,695	16,270
	M-OUT-HBSF-3-18-ALU	17.75"	aluminum	6,561	7,296	7,716	8,241	8,500	10,236	12,070	13,120	14,695	16,270
Outline Highback Sofa	M-OUT-HBSF-3-16-120-BLCK	15.75"	black	6,715	7,555	8,080	8,290		11,545	13,120	15,745	16,270	17,845
3-seater - 120cm	M-OUT-HBSF-3-18-120-BLCK	17.75"	black	6,715	7,555	8,080	8,290		11,545	13,120	15,745	16,270	17,845
	M-OUT-HBSF-3-16-120-ALU	15.75"	aluminum	6,981	7,821	8,346	8,556		11,545	13,120	15,745	16,270	17,845
	M-OUT-HBSF-3-18-120-ALU	17.75"	aluminum	6,981	7,821	8,346	8,556		11,545	13,120	15,745	16,270	17,845

HOW TO CONFIGURE

ORDER CODE EXAMPLE:

Specify:

Outline Highback Sofa 2-seater H 15.75" in Ocean 80 w/black legs

SStep 1) Choose Variant + base color
Step 2) Upholstery option
Step 3) Upholstery color

Variant + base color 2-seater, 15.75" SH - black base
Upholstery option Ocean
Upholstery Color 80
Final Pattern No: MOUTHBSF216BLCKM16180

Base Finish Options

BLCK - Black
ALU - Aluminum

Upholstery Options

A	B	C	E	G	R	T	U	V	W
Mode (M2319)	Cameo (K1443)	Chameleon (K2372)	Acca (M12660)	Modern Tweed (K2155)**	Easy Leather (M141)	Refine Leather (M136)	Endure Leather (M137)	Grace Leather (M12374)	Allure Leather (M12375)
Ocean (M161)*	Canvas (M153)	Color Field (K2226)	Aegean (K2074)						
Remix (M156)	Clara (M154)	Hallingdal (M146)	Balder (M152)						
	Colline (M4516)	Illusion (M12654)	Beck (M6376)						
	Fiord (M155)		Divina (M150)						
	Grain (M12659)		Divina MD (M147)						
	Manner (M12665)		Divina Melange (M135)						
	Pebble Weave (M6374)*		Ecriture (M10767)						
	Pecora (M6372)*		Hearth (M12664)						
	Prairie (K1925)		Premiere (K2294)						
	Steelcut Trio (M139)		Twill Weave (M142)						
	Steelcut Quartet (M13042)		Vidar (M158)						

*Notes:

*Ocean: Color 3, 21, 32, 50, 52, 80 & 601

Pebble Weave: Color 3, 7, 8, 11, 12, 21

Pecora: Color 6049, 6083, 6084, 6093, 60112

*Prairie: All Additive Free (ADF) Colors

**Textiles are not available on the 120cm variants

Illusion - Black, Blue, Caribou, Chocolate, Ciel,

Dark Green, Dark Caramel, Grey, Light Grey, Mink,

Matrine, Petrol, Stone, Taupe, Tile

OUTLINE HIGHBACK CABIN



Highback Cabin 100 2-seater
 Shipper Colli: 5
 Gross Weight (kg): 69
 Net Weight (kg): 52
 Warranty Period: 10 years

Highback Cabin 100 3-seater
 Shipper Colli: 5
 Gross Weight (kg): 78
 Net Weight (kg): 58
 Warranty Period: 10 years

Highback Cabin 100 2-seater w/ table
 Shipper Colli: 5
 Gross Weight (kg): 98.5
 Net Weight (kg): 75.5
 Warranty Period: 10 years

Highback Cabin 120 2-seater
 Shipper Colli: 5
 Gross Weight (kg): 82
 Net Weight (kg): 58.5
 Warranty Period: 10 years

Highback Cabin 100 2-seater
 Shipper Colli: 5
 Gross Weight (kg): 92
 Net Weight (kg): 65.5
 Warranty Period: 10 years

Highback Cabin 100 2-seater w/ table
 Shipper Colli: 5
 Gross Weight (kg): 111.5
 Net Weight (kg): 82
 Warranty Period: 10 years

All Variants

HIGHBACK CABIN 2-SEATER 100CM

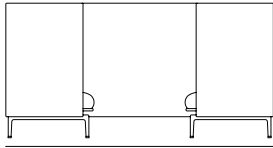

231 cm / 90.94"

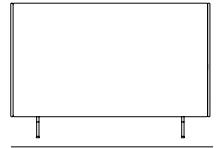

170 cm / 66.9"

115 cm / 45.3"
 SH 40 cm / 15.7"

HIGHBACK CABIN 2-SEATER 100CM - SH 45CM

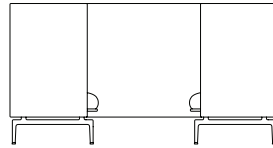

231 cm / 90.94"

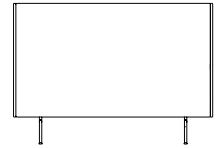

170 cm / 66.9"

120 cm / 47.3"
 SH 45 cm / 17.7"

HIGHBACK CABIN 2-SEATER 120CM

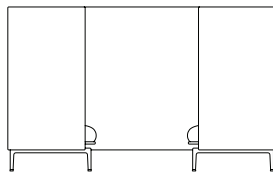

231 cm / 90.94"

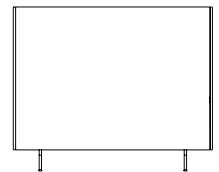

170 cm / 66.9"

140 cm / 55.12"
 SH 40 cm / 15.7"

HIGHBACK CABIN 2-SEATER 120CM - SH 45CM

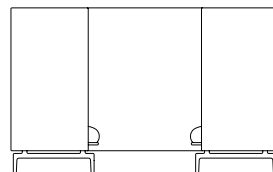

231 cm / 90.94"

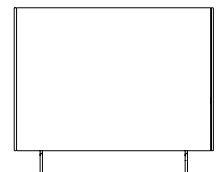

170 cm / 66.9"

145 cm / 57.09"
 SH 45 cm / 17.7"

HIGHBACK CABIN 3-SEATER 100CM

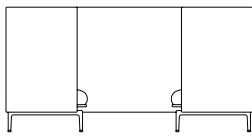

231 cm / 90.94"

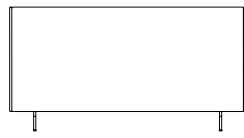

220 cm / 86.6"

115 cm / 45.3"
 SH 40 cm / 15.7"

HIGHBACK CABIN 3-SEATER 100CM - SH 45CM

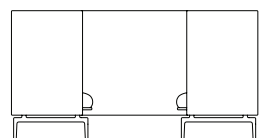

231 cm / 90.94"

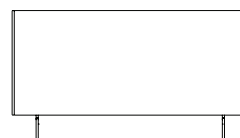

220 cm / 86.6"

120 cm / 47.3"
 SH 45 cm / 17.7"

HIGHBACK CABIN 3-SEATER 120CM

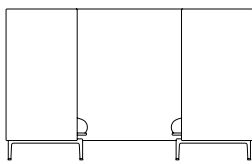

231 cm / 90.94"

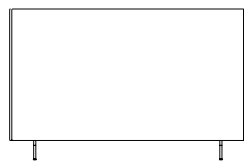

220 cm / 86.6"

140 cm / 55.12"
 SH 40 cm / 15.7"

HIGHBACK CABIN 3-SEATER 120CM - SH 45CM

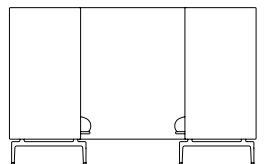

231 cm / 90.94"

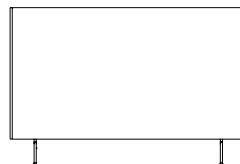

220 cm / 86.6"

145 cm / 57.09"
 SH 45 cm / 17.7"

HIGHBACK CABIN 2-SEATER W/ TABLE 100CM - SH 45CM

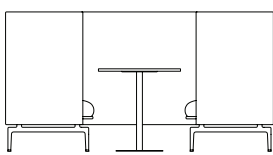

231 cm / 90.94"

Table W 70cm / 27.56"

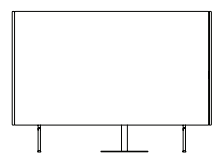

170 cm / 66.9"

120 cm / 47.3"
 SH 45 cm / 17.7"
 Table H 71 cm / 27.95"

HIGHBACK CABIN 2-SEATER 120CM W/ TABLE - SH 45CM

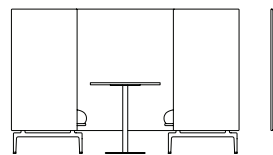

231 cm / 90.94"

Table W 70cm / 27.56"

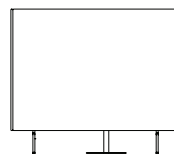

170 cm / 66.9"

145 cm / 57.09"
 SH 45 cm / 17.7"
 Table H 71 cm / 27.95"

OUTLINE HIGHBACK CABIN

All Variants

				Upholstery Grades									
				COM			CIL			COL			
Pattern No.				A	B	C	E	R	T	U	V	W	
		Seat Height	Table option	Base/Hardware color									
Outline Highback Cabin	M-OUT-HBSC-2-16-N-BLCK	15.75"	without Table	black	11,020	13,120	13,645	14,170	18,895	21,520	25,195	25,720	28,345
2-Seater - 100cm	M-OUT-HBSC-2-18-N-BLCK	17.75"	without Table	black	11,020	13,120	13,645	14,170	18,895	21,520	25,195	25,720	28,345
	M-OUT-HBSC-2-18-T-BLCK	17.75"	With Table	black	12,595	14,170	15,220	15,220	19,945	22,570	26,770	27,820	29,395
	M-OUT-HBSC-2-16-N-ALU	15.75"	without Table	aluminum	11,545	13,645	14,170	14,695	19,420	22,045	25,720	26,245	28,870
	M-OUT-HBSC-2-18-N-ALU	17.75"	without Table	aluminum	11,545	13,645	14,170	14,695	19,420	22,045	25,720	26,245	28,870
Outline Highback Cabin	M-OUT-HBSC-2-16-N-120-BLCK	15.75"	without Table	black	12,595	14,695	15,745	15,745	20,995	24,145	28,870	29,395	31,495
2-seater - 120cm	M-OUT-HBSC-2-18-N-120-BLCK	17.75"	without Table	black	12,595	14,695	15,745	15,745	20,995	24,145	28,870	29,395	31,495
	M-OUT-HBSC-2-18-T-120-BLCK	17.75"	With Table	black	14,170	15,745	16,795	17,320	22,570	25,720	30,445	30,970	33,595
	M-OUT-HBSC-2-16-N-120-ALU	15.75"	without Table	aluminum	13,120	15,220	16,270	16,270	21,520	24,670	29,395	29,395	32,545
	M-OUT-HBSC-2-18-N-120-ALU	17.75"	without Table	aluminum	13,120	15,220	16,270	16,270	21,520	24,670	29,395	29,395	32,545
Outline Highback Cabin	M-OUT-HBSC-3-16-N-BLCK	15.75"	without table	black	12,595	14,695	15,220	15,745	21,520	24,670	29,395	29,395	33,070
3-seater - 100cm	M-OUT-HBSC-3-18-N-BLCK	17.75"	without table	black	12,595	14,695	15,220	15,745	21,520	24,670	29,395	29,395	33,070
	M-OUT-HBSC-3-16-N-ALU	15.75"	without table	aluminum	13,120	15,220	15,745	16,270	22,045	25,195	29,920	30,445	33,595
	M-OUT-HBSC-3-18-N-ALU	17.75"	without table	aluminum	13,120	15,220	15,745	16,270	22,045	25,195	29,920	30,445	33,595
Outline Highback Cabin	M-OUT-HBSC-3-16-120-N-BLCK	15.75"	without table	black	14,170	16,270	17,320	17,320	24,145	27,820	33,070	33,595	36,220
3-seater - 120cm	M-OUT-HBSC-3-18-N-120-BLCK	17.75"	without table	black	14,170	16,270	17,320	17,320	24,145	27,820	33,070	33,595	36,220
	M-OUT-HBSC-3-16-N-120-ALU	15.75"	without table	aluminum	14,695	16,795	17,845	17,845	24,670	28,345	33,595	33,595	36,745
	M-OUT-HBSC-3-18-N-120-ALU	17.75"	without table	aluminum	14,695	16,795	17,845	17,845	24,670	28,345	33,595	33,595	36,745

HOW TO CONFIGURE

ORDER CODE EXAMPLE:

Specify:

Outline Highback Cabin 2-seater - 100cm H 17.75" with Table in Balder 752 w/black legs

SStep 1) Choose Variant + base color
 Step 2) Upholstery option
 Step 3) Upholstery color

Variant + base color 2-seater, 15.75" SH, with Table - black base M-OUTH-HBSC-2-18-T-BLCK
 Upholstery option Balder M152
 Upholstery Color 752 752
 Final Pattern No: MOUTHBSC218T120BLCKM152752

Base Finish Options

BLCK - Black
 ALU - Aluminum
 * Aluminum base not available for Cabin w/ Table

Upholstery Options

A	B	C	E	R	T	U	V	W
Mode (M2319)	Cameo (K1443)	Chameleon (K2372)	Acca (M12660)	Easy Leather (M141)	Refine Leather (M136)	Endure Leather (M137)	Grace Leather (M12374)	Allure Leather (M12375)
Ocean (M161)*	Canvas (M153)	Color Field (K2226)	Aegean (K2074)					
Remix (M156)	Clara (M154)	Hallingdal (M146)	Balder (M152)					
	Colline (M4516)	Illusion (M12654)	Beck (M6376)					
	Fiord (M155)		Divina (M150)					
	Grain (M12659)		Divina MD (M147)					
	Manner (M12665)		Divina Melange (M135)					
	Pebble Weave (M6374)*		Ecriture (M10767)					
	Pecora (M6372)*		Hearth (M12664)					
	Steelcut Trio (M139)		Premiere (K2294)					
	Prairie (K1925)		Twill Weave (M142)					
	Steelcut Quarter (M13042)		Vidar (M158)					

*Notes:
 *Ocean: Color 3, 21, 32, 50, 52, 80 & 601
 Pebble Weave: Color 3, 7, 8, 11, 12, 21
 Pecora: Color 6049, 6083, 6084, 6093, 60112
 Illusion - Black, Blue, Caribou, Chocolate, Ciel,
 Dark Green, Dark Caramel, Grey, Light Grey, Mink,
 Matrine, Petrol, Stone, Taupe, Tile

POWER OUTLET

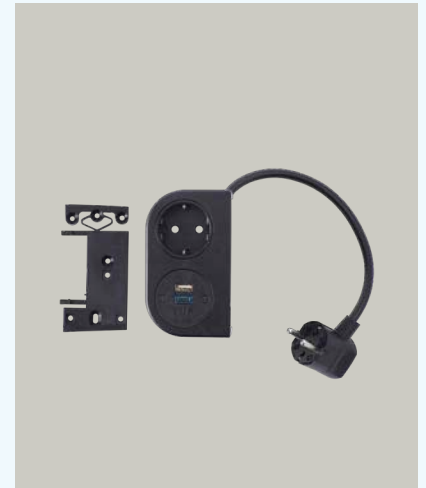

Environment	Indoor
Country of Production	United Kingdom
Assembly Required	Yes. Only need to be mounted if needed.
Cord Length	30 cm / 11.81"
Description	A Power Outlet including USB and USB-C charger. The Power Outlet can be added to the following products: Outline Sofa Series and Rest Sofa Series. Please note that Muuto does not offer installation of the Power Outlet into any Muuto products.
Materials	Outlet and cabinet are made from polycarbonate with a PVC power cord. Mounting bracket is made from nylon.
Cleaning & Care	Clean with a dry cloth.
Additional information	Available in an EU, US and UK version.
	TESTS & CERTIFICATIONS
BS6396* + BS5733-2010 IEC60884-1/IEC60950	UK safety certificate. *Fusing (UK only) International safety certificate
EN61204-3/CISPR22	UL962A / UL60950-1 CSA22.2
CE marking	All units built with UK and European socket types are CE marked by OE Electrics
EN IEC 63000:2018 RoHS	Assessment of electrical and electronic products



Shipper Colli | 1
Gross Weight (kg) | 0.41
Net Weight (kg) | 0.345
Please note | The Power Outlet can be added to the following products: Outline Sofa Series and Rest Sofa Series.
Warranty Period | 5 years

Pattern No.	Color	Contract Price	Lead Time
Ready-To-Ship US Warehouse			
MPWROUT	Power Outlet - Black	USD 572.00	-

REFLECT SIDEBOARD

"Reflect owes its stunning and unique looks to the phenomenon under which it was envisioned: The natural light of Scandinavia. The four corners on each front have a unique thickness and curve that contributes to the light reflections of the drawers."

— Søren Rose



Designed by	Søren Rose Studio
Environment	Indoor
Country of Production	Slovenia
Assembly Required	No
Description	The Reflect Sideboard is a storage unit with equal emphasis on functionality and aesthetics. With a curved surface in wood that echoes light, the Reflect Sideboard is Nordic craftsmanship and design in a modern context.
Material	MDF board with veneer in oak. Solid oak legs and apron. Black version with water-based lacquer. Natural oak version is oiled with white pigment oil.
Cleaning & Care	<p>Oiled Oak: Upon receiving your Sideboard, we recommend that the surfaces are treated with a special oak wood oil, improving its resistance to stains and fluids. We also recommend that you continue caring for the product by repeating this treatment 2-3 times a year. We recommend using a tabletop oil with a small amount of white pigment, suitable for food applications*. Clean the tabletop often and carefully with a soft and dry cloth following the wood's grain patterns. The product should not be exposed to excessive humidity, heat, or direct sunlight. Avoid placing the table in the immediate distance of a heat source. Do not place hot or wet objects directly on the table, as it may leave a mark on the tabletop. Metal objects can leave a mark if left on the table for a longer period of time.</p> <p>Any spills should immediately be removed to avoid discoloring. Clean the table top often and carefully with a soft and dry cloth following the wood's grain patterns.</p> <p>Black Lacquered Oak: Clean the sideboard with a damp cloth. If necessary, only use a mild detergent or washing up liquid that is non-concentrated. Always wipe with a dry cloth afterward. To minimize the risk of stains and marks, liquid, grease etc., should be removed straight away. Avoid placing the table in the immediate distance of a heat source. Do not place hot or wet objects directly on the table, as it may leave a mark on the tabletop. Metal objects can leave a mark if left on the table for a longer period of time.</p> <p>*Muuto recommends that you contact your local hardware store to get advice on oils for indoor use.</p>
EN 16121:2013 - LI	TESTS & CERTIFICATIONS Non-domestic storage furniture requirements for safety, strength, durability and stability
EN 16122:2012	Domestic and non-domestic storage furniture – Test method for the determination of strength, durability and stability

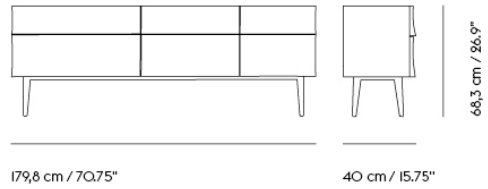

Shipper Colli 1
 Gross Weight (kg) 147.6
 Net Weight (kg) 71
 Warranty Period 5 years

Pattern No.	Color	Contract Price	Lead Time
Ready-To-Ship US Warehouse			
MRFLSBLG-BLCK	Black	USD 4,671.00	-
MRFLSBLG-OAK	Oiled Oak	USD 4,671.00	-

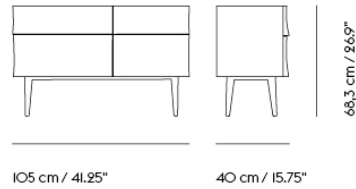

Shipper Colli 1
 Gross Weight (kg) 92
 Net Weight (kg) 50
 Warranty Period 5 years

Pattern No.	Color	Contract Price	Lead Time
Ready-To-Ship EU Warehouse			
MRFLSBSM-BLCK	Black	USD 3,145.00	-
MRFLSBSM-OAK	Oiled Oak	USD 3,145.00	-

RELATE SIDE TABLE

"We were seeking to design a simple, comfortable and easy-to-use side table that would make a natural complement to any lounge, work or home setting. With two soft gentle shapes connected by a bent metal bar, the Relate Side Table makes a subtle yet bold statement, serving a functional purpose while adding a touch of modern design to any space."

— Big-Game



Designed by	Big-Game
Environment	Indoor
Country of Production	Denmark
Assembly Required	Yes
Description	An elegant side table with two planes, connected through a graphic leg for a modern expression. Pull the Relate Side Table up to a sofa to use as a hot desk or place it in any space to hold various objects.
Material	Tabletop in either Linoleum on MDF, oak laminate on MDF, oiled Solid Oak or oiled Smoked Oak. Frame in powder coated steel.
Cleaning & Care	<p>Laminate & Linoleum: Clean the table with a damp cloth. If necessary, only use a mild detergent or washing up liquid and not concentrated. Always wipe with a dry cloth afterwards. To minimize the risk of stains and marks, liquid, grease etc. should be removed straight away. For linoleum versions, linoleum care is recommended for optimal saturation of the natural material 2-3 times a year. It is recommended to clean linoleum versions with a damp cloth and a pH neutral cleaner and wipe dry to remove any residues.</p> <p>Solid Oak & Solid Smoked Oak: Upon receiving your table, we recommend that tabletop and bottom is treated with special oak wood oil, improving its resistance to stains and fluids*. We also recommend that you continue caring for the product by repeating this treatment 2-3 times a year. For products in Solid Oak, we recommend using a tabletop oil with a small amount of white pigment, suitable for food applications*. For products in Smoked Oak, we recommend using a smoked tabletop oil, suitable for food applications*. Clean tabletop often and carefully with a soft and dry cloth following the wood's grain patterns. The product should not be exposed to excessive humidity, heat, or direct sunlight.</p> <p>Avoid placing the table in the immediate distance of a heat source. Do not place hot or wet objects directly on the table, as they can leave a mark on the tabletop. Metal objects can leave a mark if left on the table for a longer period of time.</p> <p>Any spill should immediately be removed to avoid discoloring. Clean the table top often and carefully with a soft and dry cloth following the wood's grain patterns.</p> <p>*Muuto recommends that you contact your local hardware store to get advice on oils for indoor use.</p>

RELATE SIDE TABLE

EN 15379:2016 - L3

TESTS & CERTIFICATIONS

Extreme use. Furniture – Strength, durability and safety. Requirements for non-domestic tables.

VOC CDPH 01350 & VOC BIFMA X7.1.

Relate Side Table in Solid Oak, Smoked Oak, Laminate and Oak Laminate are tested to VOC CDPH 01350 and VOC BIFMA X7.1. Standard Test Method for Determining VOC Emissions from Office Furniture Systems, Components and Seating.

RELATE SIDE TABLE / H 60,5CM / 23.82"

380

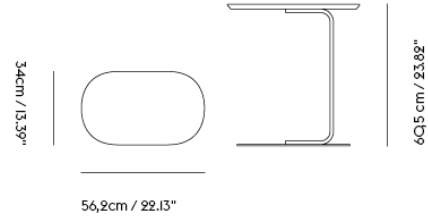

Shipper Colli	1
Gross Weight (kg)	12.577
Net Weight (kg)	11.5
Warranty Period	5 Years

Pattern No.	Color	Contract Price	Lead Time
Ready-To-Ship US Warehouse			
MRELST23-OAK-BLCK	Oak Veneer/Black ***	USD 629.00	-
MRELST23-OAK-OWHT	Oak Veneer/Off-White ***	USD 629.00	-
MRELST23-BLCK-BLCK	Black	USD 576.00	-
MRELST23-BUGY-BUGY	Blue-Grey	USD 576.00	-
MRELST23-DKGN-DKGN	Dark Green	USD 576.00	-
MRELST23-OWHT-OWHT	Off-White	USD 576.00	-
MRELST23-SOAK-OWHT	Solid Oak/Off-White	USD 629.00	-
MRELST23-SMOAK-BLCK	Solid Smoked Oak/Black	USD 629.00	-
Extras			
70704	70704	USD 23.00	-

RELATE SIDE TABLE / H: 73,5 CM / 29"

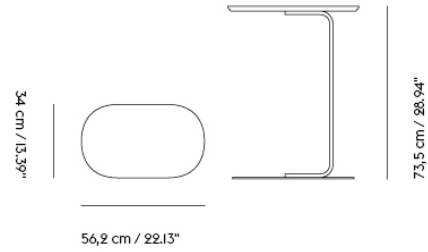

Shipper Colli	1
Gross Weight (kg)	15.65
Net Weight (kg)	14.2
Warranty Period	5 Years

Pattern No.	Color	Contract Price	Lead Time
Ready-To-Ship US Warehouse			
MRELST29-OAK-BLCK	Oak Laminate/Black	USD 667.00	-
MRELST29-OAK-OWHT	Oak Veneer/Off-White ***	USD 667.00	-
MRELST29-BLCK-BLCK	Black	USD 614.00	-
MRELST29-BUGY-BUGY	Blue-Grey	USD 614.00	-
MRELST29-DKGN-DKGN	Dark Green	USD 614.00	-
MRELST29-OWHT-OWHT	Off-White	USD 614.00	-
MRELST29-SOAK-OWHT	Solid Oak/Off-White	USD 667.00	-
MRELST29-SMOAK-BLCK	Solid Smoked Oak/Black	USD 667.00	-
Extras			
70704	70704	USD 23.00	-

REST SOFA SERIES

"The Rest Sofa Series brings a warm and inviting appearance to modern spaces through its deep comfort and friendly lines. With its ultra-soft cushioning and subtle details of its folded armrest and modern outline, the design brings new perspectives to the modern Scandinavian sofa for spending a whole day in."

— Anderssen & Voll



Designed by	Anderssen & Voll
Environment	Indoor
Country of Production	Lithuania
Assembly Required	Yes - Mount legs. Detachable Armrest.
Description	The Rest Sofa combines deep comfort with modern lines and an inherently soft seat. Referencing the ideas of Scandinavian design, the Rest Sofa features subtle details through its small folds, paired with its inviting shape.
Material	Frame and legs are made in FSC™-certified (FSC-CO28824) wood. Frame in plywood and High-Density Fiberboard (HDF), zig-zag springs, cold foam, and wadding. Upholstered in high-quality textiles. Legs in natural solid oak. EU/US version: Standard and high-resilience polyurethane foam.
Cleaning & Care	In case of stains, we generally recommend removing non-greasy stains by carefully dabbing them with a lint-free cloth or sponge wrung out in clean, warm water. Clean by dabbing with soapy water made with a bit of dish soap if necessary. Finally, dab the surface with clean water. We advise visiting Kvadrat.dk , Nevotex.dk , Maharam.com , or Gabriel.dk for further cleaning and maintenance instructions for your chosen textile, as the cleaning methods may vary from one textile to another.
Additional Product Information	A Power Outlet including USB and USB-C charger can be added to the Rest Sofa Series. The Power Outlet is available in an EU, US and UK version. Please note that Muuto does not offer installation of the Power Outlet into any Muuto products.
2-Seater	CUSTOMIZED UPHOLSTERY Textile upholstery: 10,5 m / 11.5 yds
3-Seater	Textile upholstery: 12,7 m / 13.9 yds
Pouf	Textile upholstery: 2,9 m / 3.2 yds
	TESTS & CERTIFICATIONS
EN 1022:2005	Domestic furniture - Seating - Determination of stability.
EN 16139:2013 - L2	Extreme use. Furniture - Strength, durability and safety. Requirements for non-domestic seating.
ANSI/BIFMA X5.4-2020	American National Standard for Office Furnishings - Lounge and Public Seating.
Forest Stewardship Council™	Frame and legs are made in FSC™-certified (FSC-CO28824) wood.

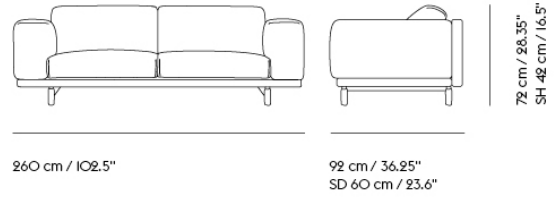

Shipper Colli |
Gross Weight (kg) 109
Net Weight (kg) 104
Warranty Period 10 years

Pattern No.	Color	Contract Price	Lead Time
Ready-To-Ship US Warehouse			
MRSTSF3-M14813	Vancouver I3/Oak ***	USD 5,140.00	-
MRSTSF3-M139133	Steelcut Trio I33/Oak ***	USD 6,036.00	-
Extras			
MLEGSRSF-GREY	Sofa Legs for Rest Sofa 2 and 3-Seater - Grey	USD 198.00	-
MLEGSRSF-BLCK	Sofa Legs for Rest Sofa 2 and 3-Seater - Black	USD 198.00	-
MPWROUT	Power Outlet - Black	USD 572.00	-

REST SOFA

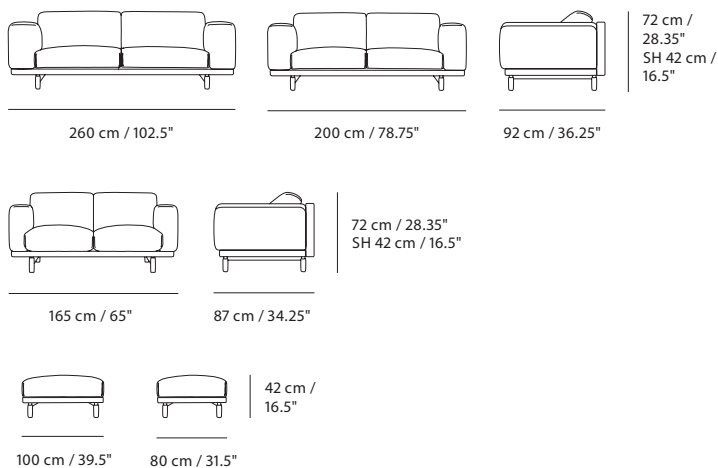

Rest Studio:
 Shipper Colli 1
 Gross Weight (kg) 75
 Net Weight (kg) 70
 Warranty Period 10 years

Rest Pouf:
 Shipper Colli 1
 Gross Weight (kg) 23
 Net Weight (kg) 20
 Warranty Period 10 years

All Variants

		Upholstery Grades			
		A	COM B	CIL C	E
Pattern No.					
2-seater w/ oak legs	M-RSTSF-2	4,615	5,140	5,406	6,036
3-seater w/ oak legs	M-RSTSF-3	5,140	6,036	6,295	7,240
Pouf	M-RSTP	1,570	1,675	1,836	2,305

HOW TO CONFIGURE

Specify:

Step 1) Choose Variant
 Step 2) Textile
 Step 3) Textile color

ORDER CODE EXAMPLE:

Rest 2-seater Sofa in Remix 133

Variant	Rest 2-seater sofa	MRSTSF2
Textile	Remix	M156
Textile Color	133	33
Final Pattern No:	MRSTSF2M156133	

Upholstery Options

A	B	C	E
Remix (M156)	Canvas (M153)	Hallingdal (M146)	Acca (M12660)
Vancouver (M148)	Clara (M154)		Balder (M152)
Wooly (M159)	Colline (M5416)		Beck (M6376)
Ocean (161)*	Fiord (M155)		Clay (M2449)
	Hero (M164)		Divina (M150)
	Grain (M12659)		Divina MD (M135)
	Manner (M12665)		Divina Melange (M147)
	Steelcut (M149)		Ecriture (M10767)
	Steelcut Trio (M139)		Hearth (M12664)
			Planum (M5904)
			Twill Weave (M142)
			Vidar (M158)

*Notes:
 *Ocean: Color 3, 21, 32, 50, 52, 80 & 601

SOFT TABLE SERIES

"I wanted to create something that was subtle yet characterful with the Soft Table Family, making a world of softened surfaces and understated functionalities come together into one. Referencing the archetypal center table, the Soft Table has a quiet presence that allows for it to complement any atmosphere while echoing a modern elegance through its refined lines and slender form."

— Jens Fager



Designed by	Jens Fager
Environment	Indoor
Country of Production	Denmark
Assembly Required	Yes
Description	The Soft Table Series is incredibly versatile, offering a wide range of design possibilities and user-centric features. Both subtle yet characterful with its softened surfaces and understated functionalities, these tables come in a variety of sizes and finishes that will complement any atmosphere and space.
Material	<p>The Soft Table's base is made from powder coated, die-casted aluminum (made with at least 97 % recycled aluminum) and comes with pre-mounted glides. Tabletop in MDF with nanolaminate (Black), laminate (Beige Green & Orange) or linoleum (Grey) surface, in Solid Oiled Oak, Solid Smoked Oak or in Solid Dark Oiled Oak.</p> <p>Laminate, Solid Oiled Oak, Solid Smoked Oak and Solid Dark Oiled Oak tabletops are made using FSC™-certified (FSC-CO28824) wood.</p>
Cleaning & Care	<p>Powder-coated surfaces: Clean with a moist cloth. If necessary, use a little dish soap on the cloth. Wipe with a clean moist cloth afterwards.</p> <p>Laminate & Linoleum: Clean the table with a damp cloth. If necessary, only use a mild detergent or washing-up liquid, and not concentrate. Always wipe with a dry cloth afterward. Liquid, grease, etc., should be removed immediately to minimize the risk of stains and marks. For linoleum versions, linoleum care is recommended for optimal saturation of the natural material 2-3 times a year. It is recommended to clean linoleum versions with a damp cloth and a pH-neutral cleaner and wipe dry to remove any residues.</p> <p>Solid Oiled Oak, Smoked Oak & Dark Oiled Oak: Upon receiving your table, we recommend treating the tabletop and bottom with special oak wood oil, improving its resistance to stains and fluids*. We also recommend you continue caring for the product by repeating this treatment 2-3 times yearly. For products in Solid Oak, we recommend using a tabletop oil with a small amount of white pigment, suitable for food applications*. For products in Smoked Oak or Dark Oiled Oak, we recommend using a smoked tabletop oil, ideal for food applications*. Clean the tabletop often and carefully with a soft, dry cloth following the wood's grain patterns. The product should not be exposed to excessive humidity, heat, or direct sunlight. Avoid placing the table in the immediate distance of a heat source. Do not place hot or wet objects directly on the table; they can leave a mark on the tabletop. Metal objects can leave a mark if left on the table for extended periods. Any spill should immediately be removed to avoid discoloring. Clean the table top often and carefully with a soft, dry cloth following the wood's grain patterns.</p> <p>*Muuto recommends contacting your local hardware store for advice on oils for indoor use.</p>

	TEST & CERTIFICATES
ANSI/BIFMA X5.5-2014	American National Standard for Office Furnishings - Desk Products.
EN 15372:2016 - L3	Severe use. Furniture - Strength, durability and safety. Requirement for non-domestic tables.
Forest Stewardship Council™	The Soft Side Tables with Solid Oiled Oak, Solid Smoked Oak, Solid Dark Oiled Oak and Laminate tabletops are made from FSC™-certified (FSC-CO28824) wood.
EU Ecolabel	The Soft Side Table with Solid Oiled Oak, Solid Smoked Oak, Solid Dark Oiled Oak and Laminate tabletops are EU Ecolabel Certified. By carrying the EU Ecolabel Certification, the product is guaranteed to have a reduced environmental impact throughout the total lifecycle of the product from raw material to disposal.
VOC CDPH 01350 & VOC BIFMA X7.1.	Soft Table Series is tested to VOC CDPH 01350 and VOC BIFMA X7.1. Standard Test Method for Determining VOC Emissions from Office Furniture Systems, Components and Seating.

SOFT SIDE TABLE / Ø 41 H: 40 CM / Ø 16.1" H: 15.7"

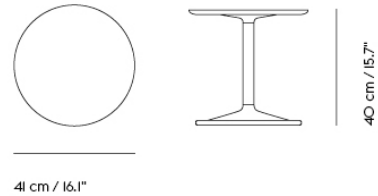

Shipper Colli	2
Gross Weight (kg)	8.873
Net Weight (kg)	7.158
Warranty period	10 years

Pattern No.	Color	Contract Price	Lead Time
Ready-To-Ship US Warehouse			
MSFTSTO1616L-DGRN-DGRN	Dusty Green Laminate/Dusty Green ***	USD 541.00	-
MSFTSTO1616O-OWHT-OWHT	Off-White Linoleum/Off-White ***	USD 541.00	-
MSFTSTO1616L-ORNG-ORNG	Orange Laminate/Orange	USD 541.00	-
MSFTSTO1616N-BLCK-BLCK	Black Nanolaminate/Black	USD 541.00	-
MSFTSTO1616O-GREY-GREY	Grey Linoleum/Grey	USD 541.00	-
MSFTSTO1616W-OWHT-SOAK	Oiled Oak/Off-White	USD 629.00	-
MSFTSTO1616O-GREY-SOAK	Solid Oak/Grey	USD 629.00	-
MSFTSTO1616W-BLCK-SMOAK	Solid Smoked Oak/Black	USD 629.00	-
Ready-To-Ship EU Warehouse			
MSFTSTO1616L-BGRN-BGRN	Beige Green Laminate/Beige Green	USD 541.00	-
Extras			
70707	70707	USD 23.00	-

SOFT SIDE TABLE / Ø 41 H: 48 CM / Ø 16.1" H: 18.9"

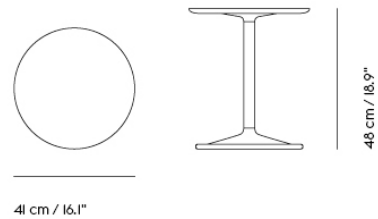

Shipper Colli	2
Gross Weight (kg)	8.873
Net Weight (kg)	7.158
Warranty period	10 years

Pattern No.	Color	Contract Price	Lead Time
Ready-To-Ship US Warehouse			
MSFTSTO1619L-DGRN-DGRN	Dusty Green Laminate/Dusty Green ***	USD 541.00	-
MSFTSTO1619L-ORNG-ORNG	Orange Laminate/Orange	USD 541.00	-
MSFTSTO1619N-BLCK-BLCK	Black Nanolaminate/Black	USD 541.00	-
MSFTSTO1619O-GREY-GREY	Grey Linoleum/Grey	USD 541.00	-
MSFTSTO1619O-OWHT-OWHT	Off-White Linoleum/Off-White ***	USD 541.00	-
MSFTSTO1619W-OWHT-SOAK	Oiled Oak/Off-White	USD 629.00	-
MSFTSTO1619W-BLCK-SMOAK	Oiled Smoked Oak/Black	USD 629.00	-
MSFTSTO1619O-GREY-SOAK	Solid Oak/Grey	USD 629.00	-
Ready-To-Ship EU Warehouse			
MSFTSTO1619L-BGRN-BGRN	Beige Green Laminate/Beige Green	USD 541.00	-
Extras			
70707	70707	USD 23.00	-

SOFT SIDE TABLE / Ø 48 H: 40 CM / Ø 18.9" H: 15.7"

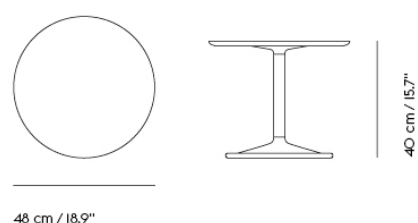

Shipper Colli	2
Gross Weight (kg)	10.776
Net Weight (kg)	8.506
Warranty period	10 years

Pattern No.	Color	Contract Price	Lead Time
Ready-To-Ship US Warehouse			
MSFTSTO1916L-DGRN-DGRN	Dusty Green Laminate/Dusty Green ***	USD 629.00	-
MSFTSTO1916L-ORNG-ORNG	Orange Laminate/Orange	USD 629.00	-
MSFTSTO1916N-BLCK-BLCK	Black Nanolaminate/Black	USD 629.00	-
MSFTSTO1916O-GREY-GREY	Grey Linoleum/Grey	USD 629.00	-
MSFTSTO1916O-OWHT-OWHT	Off-White Linoleum/Off-White ***	USD 629.00	-
MSFTSTO1916W-OWHT-SOAK	Oiled Oak/Off-White	USD 719.00	-
MSFTSTO1916W-BLCK-SMOAK	Oiled Smoked Oak/Black	USD 719.00	-
MSFTSTO1916O-GREY-SOAK	Solid Oak/Grey	USD 719.00	-
Ready-To-Ship EU Warehouse			
MSFTSTO1916L-BGRN-BGRN	Beige Green Laminate/Beige Green	USD 629.00	-
Extras			
70707	70707	USD 23.00	-

SOFT SIDE TABLE / Ø 48 H: 48 CM / Ø 18.9" H: 18.9"

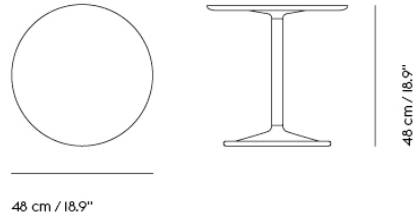

Shipper Colli	2
Gross Weight (kg)	10.776
Net Weight (kg)	8.506
Warranty period	10 years

Pattern No.	Color	Contract Price	Lead Time
Ready-To-Ship US Warehouse			
MSFTSTO1919L-DGRN-DGRN	Dusty Green Laminate/Dusty Green ***	USD 629.00	-
MSFTSTO1919L-ORNG-ORNG	Orange Laminate/Orange	USD 629.00	-
MSFTSTO1919N-BLCK-BLCK	Black Nanolaminate/Black	USD 629.00	-
MSFTSTO19190-GREY-GREY	Grey Linoleum/Grey	USD 629.00	-
MSFTSTO19190-OWHT-OWHT	Off-White Linoleum/Off-White ***	USD 629.00	-
MSFTSTO1919W-OWHT-SOAK	Oiled Oak/Off-White	USD 719.00	-
MSFTSTO1919W-BLCK-SMOAK	Oiled Smoked Oak/Black	USD 719.00	-
MSFTSTO19190-GREY-SOAK	Solid Oak/Grey	USD 719.00	-
Ready-To-Ship EU Warehouse			
MSFTSTO1919L-BGRN-BGRN	Beige Green Laminate/Beige Green	USD 629.00	-
Extras			
70707	70707	USD 23.00	-

SOFT SIDE TABLE / 45 X 45 H: 40 CM / 17.7 X 17.7 H: 15.7"

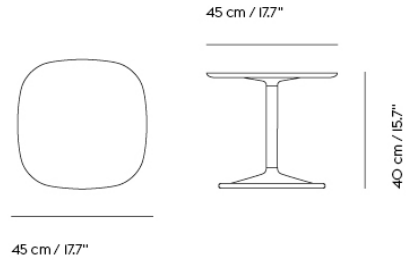

Shipper Colli 2
Gross Weight (kg) 8.939
Net Weight (kg) 7.649
Warranty period 10 years

Pattern No.	Color	Contract Price	Lead Time
Ready-To-Ship US Warehouse			
MSFTSTR171716L-DGRN-DGRN	Dusty Green Laminate/Dusty Green ***	USD 629.00	-
MSFTSTR171716L-ORNG-ORNG	Orange Laminate/Orange ***	USD 629.00	-
MSFTSTR171716N-BLCK-BLCK	Black Nanolaminate/Black ***	USD 629.00	-
MSFTSTR171716O-OWHT-OWHT	Off-White Linoleum/Off-White ***	USD 629.00	-
MSFTSTR171716W-OWHT-SOAK	Oiled Oak/Off-White ***	USD 719.00	-
MSFTSTR171716W-BLCK-SMOAK	Oiled Smoked Oak/Black ***	USD 719.00	-
Extras			
70707	70707	USD 23.00	-

SOFT SIDE TABLE / 45 X 45 H: 48 CM / 17.7 X 17.7 H: 18.9"

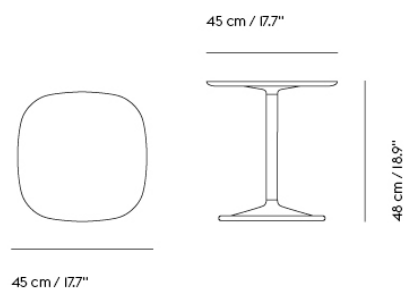

Shipper Colli	2
Gross Weight (kg)	9.02
Net Weight (kg)	7.73
Warranty period	10 years

Pattern No.	Color	Contract Price	Lead Time
Ready-To-Ship US Warehouse			
MSFTSTR171719L-DGRN-DGRN	Dusty Green Laminate/Dusty Green ***	USD 629.00	-
MSFTSTR171719L-ORNG-ORNG	Orange Laminate/Orange ***	USD 629.00	-
MSFTSTR171719N-BLCK-BLCK	Black Nanolaminate/Black ***	USD 629.00	-
MSFTSTR171719O-OWHT-OWHT	Off-White Linoleum/Off-White ***	USD 629.00	-
MSFTSTR171719W-OWHT-SOAK	Oiled Oak/Off-White ***	USD 719.00	-
MSFTSTR171719W-BLCK-SMOAK	Oiled Smoked Oak/Black ***	USD 719.00	-
Extras			
70707	70707	USD 23.00	-

SOFT COFFEE TABLE / Ø 75 H: 42 CM / Ø 27.6 H: 16.5"

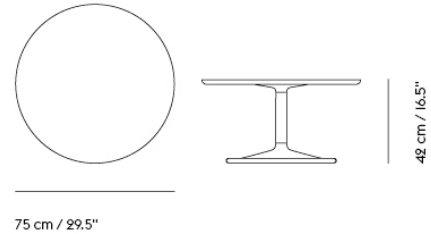

Shipper Colli	3
Gross Weight (kg)	20.923
Net Weight (kg)	16.517
Warranty period	5 years

Pattern No.	Color	Contract Price	Lead Time
Ready-To-Ship US Warehouse			
MSFTCTO3016N-BLCK-BLCK	Black Nanolaminate/Black	USD 1,311.00	-
MSFTCTO3016O-GREY-GREY	Grey Linoleum/Grey	USD 1,206.00	-
MSFTCTO3016W-BLCK-DOAK	Dark Oiled Oak/Black	USD 1,360.00	-
MSFTCTO3016W-GREY-SOAK	Solid Oak/Grey	USD 1,360.00	-
Ready-To-Ship EU Warehouse			
MSFTCTO3016L-BGRN-BGRN	Beige Green Laminate/Beige Green	USD 1,206.00	-

SOFT COFFEE TABLE / Ø 95 H: 42 CM / Ø 37.4 H: 16.5"

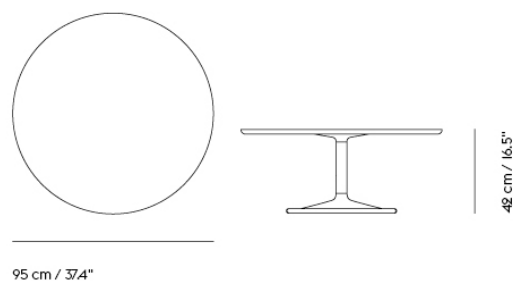
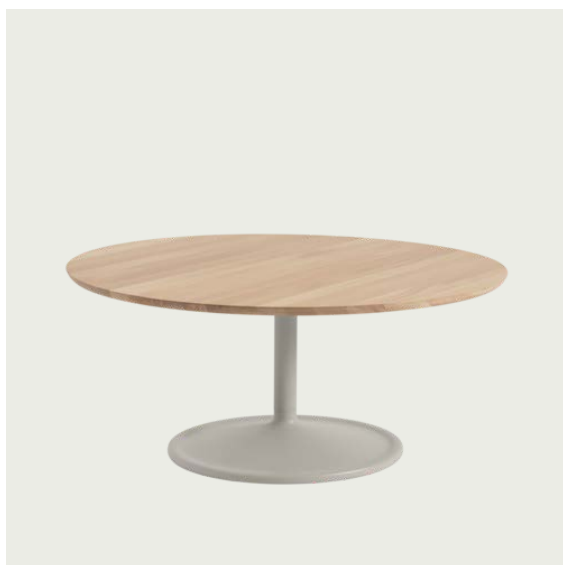

Shipper Colli	3
Gross Weight (kg)	27.823
Net Weight (kg)	22.467
Warranty period	5 years

Pattern No.	Color	Contract Price	Lead Time
Ready-To-Ship US Warehouse			
MSFTCT03716N-BLCK-BLCK	Black Nanolaminate/Black	USD 1,416.00	-
MSFTCT03716O-GREY-GREY	Grey Linoleum/Grey	USD 1,360.00	-
MSFTCT03716W-BLCK-DOAK	Dark Oiled Oak/Black	USD 1,465.00	-
MSFTCT03716W-GREY-SOAK	Solid Oak/Grey	USD 1,465.00	-
Ready-To-Ship EU Warehouse			
MSFTCT03716L-BGRN-BGRN	Beige Green Laminate/Beige Green	USD 1,360.00	-

SOFT COFFEE TABLE / 70 X 70 H: 42 CM / 27.6 X 27.6 H: 16.5"

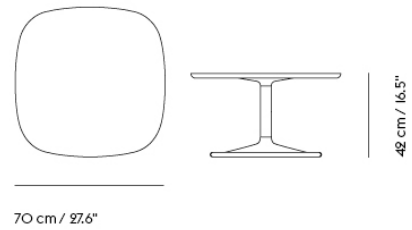

Shipper Colli 3
Gross Weight (kg) 21.823
Net Weight (kg) 17.417
Warranty period 5 years

Pattern No.	Color	Contract Price	Lead Time
Ready-To-Ship US Warehouse			
MSFTCTR303016N-BLCK-BLCK	Black Nanolaminate/Black	USD 1,311.00	-
MSFTCTR303016O-GREY-GREY	Grey Linoleum/Grey	USD 1,206.00	-
MSFTCTR303016W-BLCK-DOAK	Dark Oiled Oak/Black	USD 1,360.00	-
MSFTCTR303016W-GREY-SOAK	Solid Oak/Grey	USD 1,360.00	-
Ready-To-Ship EU Warehouse			
MSFTCTR303016L-BGRN-BGRN	Beige Green Laminate/Beige Green	USD 1,206.00	-

SOFT TABLE / Ø 95 H: 73 CM / Ø 37.4 H: 28.7"

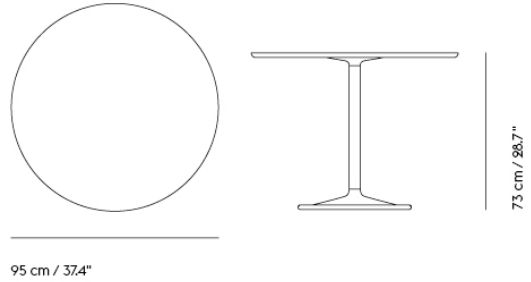

Shipper Colli 3
Gross Weight (kg) 28.3
Net Weight (kg) 22.904
Warranty period 5 years

Pattern No.	Color	Contract Price	Lead Time
Ready-To-Ship US Warehouse			
MSFTT03729N-BLCK-BLCK	Black Nanolaminate/Black	USD 1,465.00	-
MSFTT03729O-GREY-GREY	Grey Linoleum/Grey	USD 1,416.00	-
MSFTT03729W-BLCK-DOAK	Dark Oiled Oak/Black	USD 1,570.00	-
MSFTT03729W-GREY-SOAK	Solid Oak/Grey	USD 1,570.00	-
Ready-To-Ship EU Warehouse			
MSFTT03729L-BGRN-BGRN	Beige Green Laminate/Beige Green	USD 1,416.00	-

SOFT TABLE / Ø 95 H: 95 CM / Ø 37.4 H: 37.4"

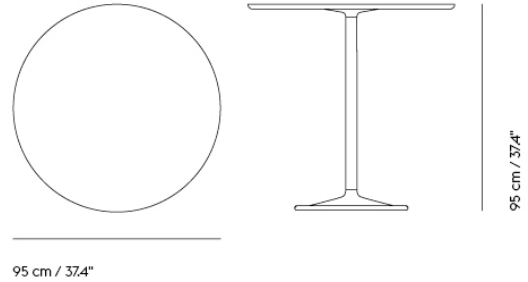

Shipper Colli	3
Gross Weight (kg)	28.623
Net Weight (kg)	23.197
Warranty period	5 years

Pattern No.	Color	Contract Price	Lead Time
Ready-To-Ship US Warehouse			
MSFTT03737N-BLCK-BLCK	Black Nanolaminate/Black	USD 1,570.00	-
MSFTT03737O-GREY-GREY	Grey Linoleum/Grey	USD 1,465.00	-
MSFTT03737W-BLCK-DOAK	Dark Oiled Oak/Black	USD 1,626.00	-
MSFTT03737W-GREY-SOAK	Solid Oak/Grey	USD 1,626.00	-
Ready-To-Ship EU Warehouse			
MSFTT03737L-BGRN-BGRN	Beige Green Laminate/Beige Green	USD 1,465.00	-

SOFT TABLE / Ø 95 H: 105 CM / Ø 37.4 H: 41.3"

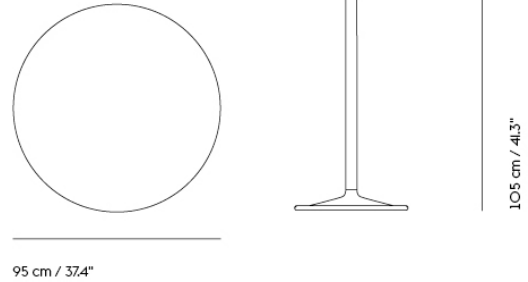

Shipper Colli	3
Gross Weight (kg)	28.777
Net Weight (kg)	23.341
Warranty period	5 years

Pattern No.	Color	Contract Price	Lead Time
Ready-To-Ship US Warehouse			
MSFTT03741N-BLCK-BLCK	Black Nanolaminate/Black	USD 1,570.00	-
MSFTT03741O-GREY-GREY	Grey Linoleum/Grey	USD 1,465.00	-
MSFTT03741W-BLCK-DOAK	Dark Oiled Oak/Black	USD 1,626.00	-
MSFTT03741W-GREY-SOAK	Solid Oak/Grey	USD 1,626.00	-
Ready-To-Ship EU Warehouse			
MSFTT03741L-BGRN-BGRN	Beige Green Laminate/Beige Green	USD 1,465.00	-

SOFT CAFÉ TABLE / 70 X 70 H: 73 CM / 27.6 X 27.6 H: 28.7"

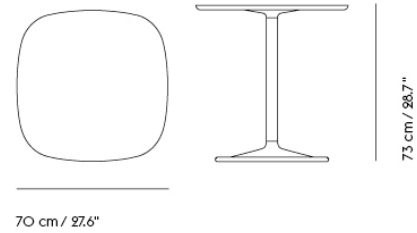

Shipper Colli	3
Gross Weight (kg)	22.3
Net Weight (kg)	17.854
Warranty period	5 years

Pattern No.	Color	Contract Price	Lead Time
Ready-To-Ship US Warehouse			
MSFTCETO2829N-BLCK-BLCK	Black Nanolaminate/Black	USD 1,360.00	-
MSFTCETR282829O-GREY-GREY	Grey Linoleum/Grey	USD 1,311.00	-
MSFTCETR282829W-BLCK-DOAK	Dark Oiled Oak/Black	USD 1,416.00	-
MSFTCETR282829W-GREY-SOAK	Solid Oak/Grey	USD 1,416.00	-
Ready-To-Ship EU Warehouse			
MSFTCETR282829L-BGRN-BGRN	Beige Green Laminate/Beige Green	USD 1,311.00	-
Extras			
70720	70720	USD 24.00	-

SOFT CAFÉ TABLE / 70 X 70 H: 95 CM / 27.6 X 27.6" H: 37.4"

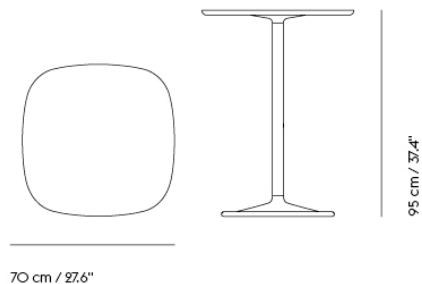

Shipper Colli	3
Gross Weight (kg)	22.623
Net Weight (kg)	18.147
Warranty period	5 years

Pattern No.	Color	Contract Price	Lead Time
Ready-To-Ship US Warehouse			
MSFTCETR282837N-BLCK-BLCK	Black Nanolaminate/Black	USD 1,416.00	-
MSFTCETR282837O-GREY-GREY	Grey Linoleum/Grey	USD 1,360.00	-
MSFTCETR282837W-BLCK-DOAK	Dark Oiled Oak/Black	USD 1,465.00	-
MSFTCETR282837W-GREY-SOAK	Solid Oak/Grey	USD 1,465.00	-
Ready-To-Ship EU Warehouse			
MSFTCETR282837L-BGRN-BGRN	Beige Green Laminate/Beige Green	USD 1,360.00	-
Extras			
70720	70720	USD 24.00	-

**SOFT CAFÉ TABLE / 70 X 70 H: 105 CM /
27.6 X 27.6" H: 41.3"**

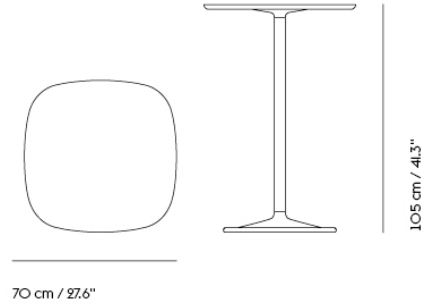

Shipper Colli 3
 Gross Weight (kg) 22.777
 Net Weight (kg) 18.291
 Warranty period 5 years

Pattern No.	Color	Contract Price	Lead Time
Ready-To-Ship US Warehouse			
MSFTCETR282841N-BLCK-BLCK	Black Nanolaminate/Black	USD 1,416.00	-
MSFTCETR282841O-GREY-GREY	Grey Linoleum/Grey	USD 1,360.00	-
MSFTCETR282841W-BLCK-DOAK	Dark Oiled Oak/Black	USD 1,465.00	-
MSFTCETR282841W-GREY-SOAK	Solid Oak/Grey	USD 1,465.00	-
Ready-To-Ship EU Warehouse			
MSFTCETR282841L-BGRN-BGRN	Beige Green Laminate/Beige Green	USD 1,360.00	-
Extras			
70720	70720	USD 24.00	-

SOFT CAFÉ TABLE / Ø 75 H: 73 CM / Ø 27.6 H: 28.7"

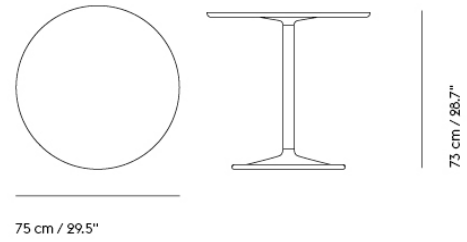

Shipper Colli 3
Gross Weight (kg) 21.4
Net Weight (kg) 16.954
Warranty period 5 years

Pattern No.	Color	Contract Price	Lead Time
Ready-To-Ship US Warehouse			
MSFTCETO2829N-BLCK-BLCK	Black Nanolaminate/Black	USD 1,360.00	-
MSFTCETO2829O-GREY-GREY	Grey Linoleum/Grey	USD 1,311.00	-
MSFTCETO2829W-BLCK-DOAK	Dark Oiled Oak/Black	USD 1,416.00	-
MSFTCETO2829W-GREY-SOAK	Solid Oak/Grey	USD 1,416.00	-
Ready-To-Ship EU Warehouse			
MSFTCETO2829L-BGRN-BGRN	Beige Green Laminate/Beige Green	USD 1,311.00	-
Extras			
70720	70720	USD 24.00	-

SOFT CAFÉ TABLE / Ø 75 H: 95 CM / Ø 27.6" H: 37.4"

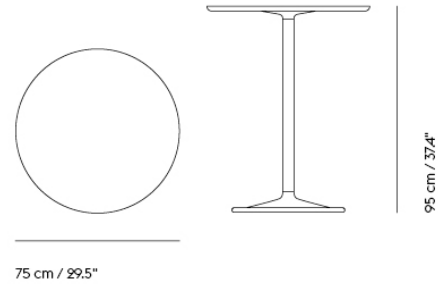

Shipper Colli	3
Gross Weight (kg)	21.723
Net Weight (kg)	17.247
Warranty period	5 years

Pattern No.	Color	Contract Price	Lead Time
Ready-To-Ship US Warehouse			
MSFTCETO2837N-BLCK-BLCK	Black Nanolaminate/Black	USD 1,416.00	-
MSFTCETO2837O-GREY-GREY	Grey Linoleum/Grey	USD 1,360.00	-
MSFTCETO2837W-BLCK-DOAK	Dark Oiled Oak/Black	USD 1,465.00	-
MSFTCETO2837W-GREY-SOAK	Solid Oak/Grey	USD 1,465.00	-
Ready-To-Ship EU Warehouse			
MSFTCETO2837L-BGRN-BGRN	Beige Green Laminate/Beige Green	USD 1,360.00	-
Extras			
70720	70720	USD 24.00	-

SOFT CAFÉ TABLE / Ø 75 H: 105 CM / Ø 27.6" H: 41.3"

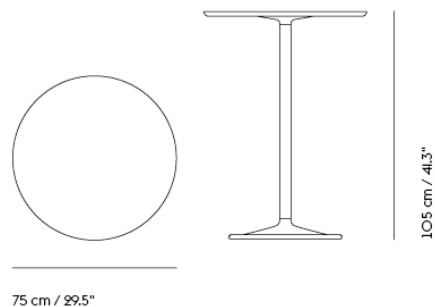

Shipper Colli	3
Gross Weight (kg)	21.877
Net Weight (kg)	17.391
Warranty period	5 years

Pattern No.	Color	Contract Price	Lead Time
Ready-To-Ship US Warehouse			
MSFTCETO2841N-BLCK-BLCK	Black Nanolaminate/Black	USD 1,416.00	-
MSFTCETO2841O-GREY-GREY	Grey Linoleum/Grey	USD 1,360.00	-
MSFTCETO2841W-BLCK-DOAK	Dark Oiled Oak/Black	USD 1,465.00	-
MSFTCETO2841W-GREY-SOAK	Solid Oak/Grey	USD 1,465.00	-
Ready-To-Ship EU Warehouse			
MSFTCETO2841L-BGRN-BGRN	Beige Green Laminate/Beige Green	USD 1,360.00	-
Extras			
70720	70720	USD 24.00	-

STACKED STORAGE SYSTEM

"The design aims at identifying this very intricate space in the world of shelving where storage, display and versatility becomes one. I have moved homes countless of times and it has made me see my belongings in a new light, valuing their ability to adapt to new and ever-changing surroundings to a high degree."

— Julien De Smedt



Designed by	Julien De Smedt
Environment	Indoor
Country of Production	Slovenia
Assembly Required	Yes - please carefully read and fully adhere to the assembly guidelines when assembling your Stacked Storage System.
Description	Being both versatile and functional, the Stacked Storage System can be arranged and rearranged for the exact configuration that you'd like, whether it be as shelving setups, sideboards, bookcases or side table. The design can easily be refreshed by playing around with the space between the modules or mounting the modules with backboard directly onto the wall.
Material	<p>Modules, plinths, and shelves are in PU lacquered MDF or Oak veneered fiberboard. The podium consists of a powder-coated steel frame and a wooden plate made from a PU lacquered MDF or oak veneered fiberboard. Clips are powder-coated bent steel with rubber inserts. The insert is made from bent powder-coated steel with rubber feet.</p> <p>Lacquered versions: Every side is cut out of MDF, glued together, and painted with three layers of PU lacquer.</p> <p>Oak versions: Every side is cut out of fiberboard with oak veneer and glued together.</p>
Cleaning & Care	<p>Natural Oak Modules Avoid using any liquid on Natural Veneer Stacked variants. Remove dust from shelves with a soft cloth. Dry any spillages immediately with a soft cloth following the wood grains. The wood should not be exposed to excessive heat, direct sunlight, or humidity. The wood surface finish will naturally fade over time.</p> <p>Lacquered Modules Clean the modules with a damp cloth. If necessary, only use a mild detergent or washing-up liquid, not concentrated. Always wipe with a dry cloth afterward. To minimize the risk of stains and marks, liquid, grease, etc., should be removed immediately. The wood should not be exposed to excessive heat, direct sunlight, or humidity. Take care when placing or moving objects on the surfaces of Stacked as scratches can quickly occur.</p> <p>Metal Surfaces Powder-coated surfaces: Clean with a moist cloth. If necessary, use a little dish soap on the cloth.</p>

STACKED STORAGE SYSTEM

Additional Product Information	<p>Max. weight per module: 25 kg / 55 lbs (free-standing) and 12 kg / 26.5 lbs (wall-mounted). Max. total weight: 300 kg / 660 lbs when evenly distributed on the Podium. Max. total height: 240 cm / 94.49" and max. 5 modules on top of one another.</p> <p>Modules must always be connected with Clips or be mounted to a wall to ensure stability of the shelving system.</p> <p>Shelves can be positioned in two fixed positions inside modules w. door. Inserts can be placed in open modules and modules w. backboard.</p>
Spare Parts	<p>Each Stacked module comes with two color matching clips, while Oak comes with Grey clips. Extra clips available as Set of 2 in the colors Brown Green, Grey and White.</p>
EN 16121:2013*	<p>TESTS & CERTIFICATIONS</p> <p>All standard configurations are tested according to European standard EN 16121:3013+A1:2017 Test Severity 2. Please follow assembly rules and configuration guidelines when building your Stacked configuration.</p>
EN 16122:2012*	<p>Domestic and non-domestic storage furniture. Test method for the determination of strength, durability and stability.</p> <p>The Stacked Storage System* complies with the European requirements for safety, strength, durability and stability within storage — EN 16121:2013 and EN 16122:2012. *Test approved for single modules and all Stacked Storage System configurations.</p>

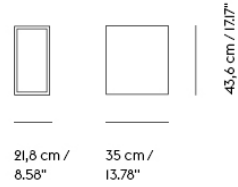
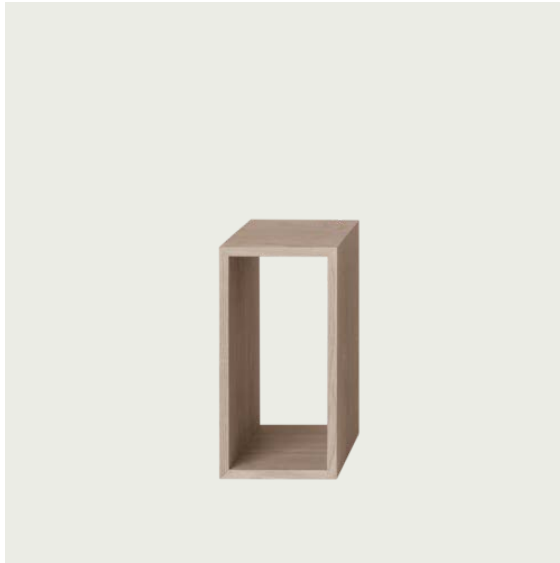

Shipper Colli 1
Gross Weight (kg) 8.9
Net Weight (kg) 6.7
Warranty period 5 years

Pattern No.	Color	Contract Price	Lead Time
Ready-To-Ship US Warehouse			
MSSTMSO-GREY	Grey ***	USD 226.00	-
MSSTMSO-MBLU	Midnight Blue	USD 226.00	-
MSSTMSO-OAK	Oak	USD 226.00	-
MSSTMSO-WHIT	White	USD 226.00	-

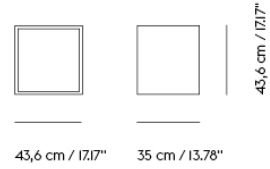

Shipper Colli 1
Gross Weight (kg) 11.9
Net Weight (kg) 9.1
Warranty period 5 years

Pattern No.	Color	Contract Price	Lead Time
Ready-To-Ship US Warehouse			
MSSTMMO-GREY	Grey ***	USD 289.00	-
MSSTMMO-MBLU	Midnight Blue	USD 289.00	-
MSSTMMO-OAK	Oak	USD 289.00	-
MSSTMMO-WHIT	White	USD 289.00	-

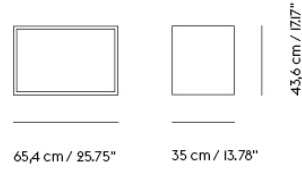

Shipper Colli 1
 Gross Weight (kg) 14.8
 Net Weight (kg) 11.8
 Warranty period 5 years

Pattern No.	Color	Contract Price	Lead Time
Ready-To-Ship US Warehouse			
MSSTMLO-GREY	Grey ***	USD 331.00	-
MSSTMLO-MBLU	Midnight Blue ***	USD 331.00	-
MSSTMLO-OAK	Oak	USD 331.00	-
MSSTMLO-WHIT	White	USD 331.00	-
Ready-To-Ship EU Warehouse			
MSSTMLO-GREY	Grey ***	USD 331.00	-

STACKED STORAGE SYSTEM / SMALL WITH BACKBOARD

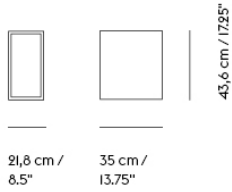

Shipper Colli 1
Gross Weight (kg) 10
Net Weight (kg) 7.2
Warranty period 5 years

Pattern No.	Color	Contract Price	Lead Time
Ready-To-Ship US Warehouse			
MSSTMSB-GREY	Grey ***	USD 257.00	-
MSSTMSB-MBLU	Midnight Blue	USD 257.00	-
MSSTMSB-OAK	Oak	USD 257.00	-
MSSTMSB-WHIT	White	USD 257.00	-

STACKED STORAGE SYSTEM / MEDIUM WITH BACKBOARD

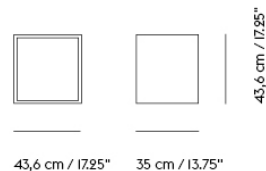
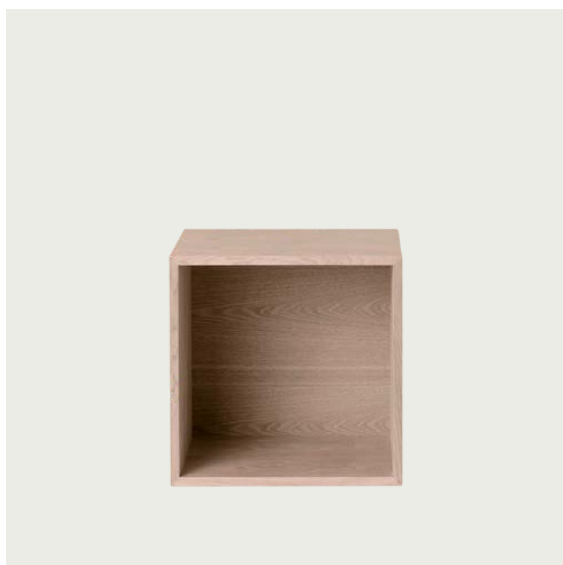

Shipper Colli	1
Gross Weight (kg)	13.3
Net Weight (kg)	10.2
Warranty period	5 years

Pattern No.	Color	Contract Price	Lead Time
Ready-To-Ship US Warehouse			
MSSTMMB-GREY	Grey ***	USD 331.00	-
MSSTMMB-OAK	Oak	USD 331.00	-
MSSTMMB-ODGRN	Oak/Dusty Green	USD 331.00	-
MSSTMMB-OGREY	Oak/Grey	USD 331.00	-
MSSTMMB-WHIT	White	USD 331.00	-

STACKED STORAGE SYSTEM / LARGE WITH BACKBOARD

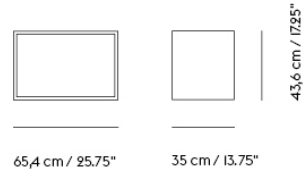

Shipper Colli 1
Gross Weight (kg) 16.42
Net Weight (kg) 12.8
Warranty period 5 years

Pattern No.	Color	Contract Price	Lead Time
Ready-To-Ship US Warehouse			
MSSTMLB-GREY	Grey ***	USD 362.00	-
MSSTMLB-OAK	Oak	USD 362.00	-
MSSTMLB-WHIT	White	USD 362.00	-
Ready-To-Ship EU Warehouse			
MSSTMLB-MBLU	Midnight Blue	USD 362.00	-

STACKED STORAGE SYSTEM / MEDIUM WITH DOOR

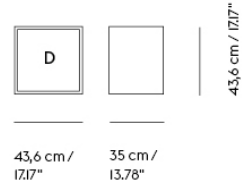

Shipper Colli 1
 Gross Weight (kg) 15.5
 Net Weight (kg) 12.3
 Warranty period 5 years

Pattern No.	Color	Contract Price	Lead Time
Ready-To-Ship US Warehouse			
MSSTMMD-GREY	Grey ***	USD 341.00	-
MSSTMMD-MBLU	Midnight Blue	USD 341.00	-
MSSTMMD-OAK	Oak	USD 341.00	-
MSSTMMD-WHIT	White	USD 341.00	-

STACKED STORAGE SYSTEM / CLIPS SET OF 5



Shipper Colli 1
Gross Weight (kg) 0.194
Net Weight (kg) 0.187
Warranty period 5 years

Pattern No.	Color	Contract Price	Lead Time
Ready-To-Ship US Warehouse			
MSSTC-DGRN	Dusty Green	USD 39.00	-
MSSTC-LIGY	Grey	USD 39.00	-
MSSTC-MBLU	Midnight Blue	USD 39.00	-
MSSTC-WHIT	White	USD 39.00	-
Ready-To-Ship EU Warehouse			
MSSTC-GREY	Grey	USD 39.00	-

STACKED STORAGE SYSTEM / ACOUSTIC PANEL / SMALL

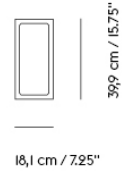

Shipper Colli 1
Gross Weight (kg) 0.25
Net Weight (kg) 0.15
Warranty period 5 years

Pattern No.	Color	Contract Price	Lead Time
Ready-To-Ship EU Warehouse			
MSSTAPSM-AQME	Aqua Mélange	USD 72.00 >MOQ: 2	-
MSSTAPSM-BLME	Black Mélange	USD 72.00 >MOQ: 2	-
MSSTAPSM-GRME	Grey Mélange	USD 72.00 >MOQ: 2	-

STACKED STORAGE SYSTEM / ACOUSTIC PANEL - MEDIUM

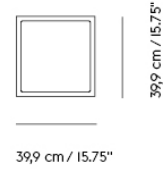
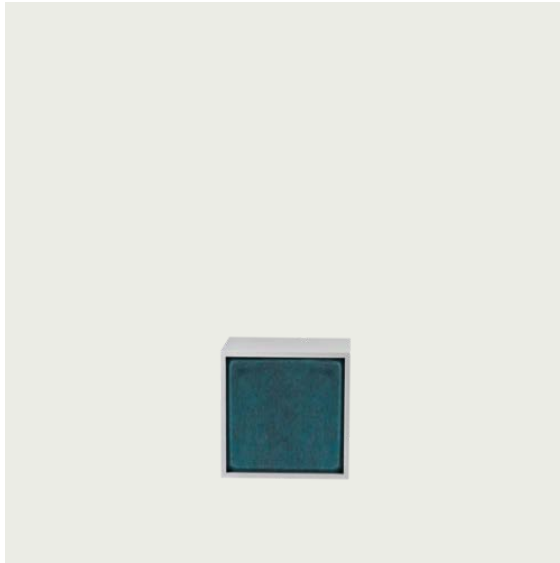

Shipper Colli 1
Gross Weight (kg) 0.4
Net Weight (kg) 0.3
Warranty period 5 years

Pattern No.	Color	Contract Price	Lead Time
Ready-To-Ship EU Warehouse			
MSSTAPMD-AQME	Aqua Mélange	USD 100.00 >MOQ: 2	-
MSSTAPMD-BLME	Black Mélange	USD 100.00 >MOQ: 2	-
MSSTAPMD-GRME	Grey Mélange	USD 100.00 >MOQ: 2	-

STACKED STORAGE SYSTEM / ACOUSTIC PANEL / LARGE

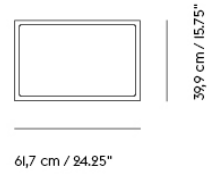

Shipper Colli 1
Gross Weight (kg) 0.6
Net Weight (kg) 0.5
Warranty period 5 years

Pattern No.	Color	Contract Price	Lead Time
Ready-To-Ship EU Warehouse			
MSSTAPLG-BLME	Black Mélange	USD 121.00 >MOQ: 2	-
MSSTAPLG-GRME	Grey Mélange	USD 121.00 >MOQ: 2	-

STILL CAFÉ TABLE

"Our idea for the Still Café Table was to create a design with an apparent function that would fit intuitively into any space without making much visual noise. With its elegant four-legged base across various heights, the design is stripped to its essentials, complemented by the angled edges of its table top."

— Iskos-Berlin



Designed by	Iskos-Berlin
Environment	Indoor
Country of Production	Denmark
Assembly Required	Yes
Description	The Still Café Table is designed with a clean expression and apparent function on a four legged base, complemented by the angled edges of its table top. Available across various heights with either round or square table top, the Still Café Table is an elegant match for any kitchen area, café, restaurant, bar, conference or office setting. The higher versions also function as a hot-desk in workplaces and open areas.
Material	Table top is made from MDF with either a linoleum or nanolaminate finish and lacquered edges. Nanolaminate table tops are made using FSC™-certified (FSC-CO28824) wood. Base is made from die-casted aluminum. The mounting plate and tube are in powder coated steel.
Cleaning & Care	<p>Powder coated surfaces: Clean with a moist cloth. If necessary use a little dish soap on the cloth.</p> <p>Nanolaminate: Clean the table with a damp cloth. If necessary only use a mild detergent or washing up liquid and not concentrated. Always wipe with a dry cloth afterwards. To minimize the risk of stains and marks, liquid, grease etc. should be removed straight away. Treat the surface with a melamine sponge, available in hardware stores, to reduce minor scratches.</p> <p>Linoleum: Clean the table with a damp cloth. If necessary use a mild detergent or washing up liquid and not concentrated. Always wipe with a dry cloth afterwards. To minimize the risk of stains and marks, liquids, grease etc. should be removed straight away. For linoleum versions it is recommended to use a linoleum polish on the surface when needed.</p>
EN 15372:2016 - L3	<p>TESTS & CERTIFICATIONS</p> <p>Extreme use. Furniture – Strength, durability and safety. Requirements for non-domestic tables.</p>
ANSI/BIFMAX5.5-2014	American National Standard for Office. Furnishings - Desk Products.
Forest Stewardship Council™	Nanolaminate table tops are made using FSC™-certified (FSC-CO28824) wood.
VOC CDPH 01350 & VOC BIFMA X7.1.	Still Café Table is tested to VOC CDPH 01350 and VOC BIFMA X7.1. Standard Test Method for Determining VOC Emissions from Office Furniture Systems, Components and Seating.

STILL CAFÉ TABLE / 75 X 65 H: 73 CM / 29.5 X 25.6 H: 28.7"

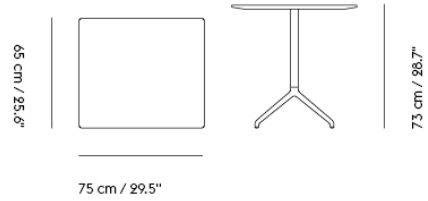

Shipper Colli	2
Gross Weight (kg)	18.3
Net Weight (kg)	13.352
Base color options	Black, White
Warranty Period	10 years

Pattern No.	Color	Contract Price	Lead Time
Ready-To-Ship US Warehouse			
MSTLCTR302629N-BLCK-BLCK	Black Nanolaminate/Anthracite Black	USD 923.00	-
MSTLCTR302629N-WHIT-BLCK	Black Nanolaminate/White	USD 923.00	-
MSTLCTR302629N-BLCK-WHIT	White Nanolaminate/Anthracite Black	USD 923.00	-
MSTLCTR302629N-WHIT-WHIT	White Nanolaminate/White	USD 923.00	-
Made-To-Order			
MSTLCTR302629O-BLCK-BLCK	Black Linoleum/Anthracite Black	USD 923.00	-
MSTLCTR302629O-WHIT-BLCK	Black Linoleum/White	USD 923.00	-
Extras			
70705	70705	USD 23.00	-

STILL CAFÉ TABLE / 75 X 65 H: 95 CM / 29.5 X 25.6 H: 37.4"

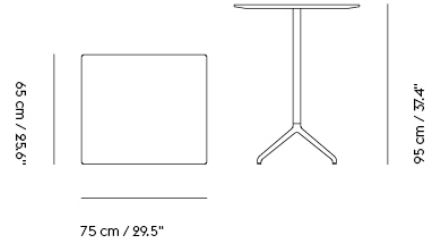

Shipper Colli	2
Gross Weight (kg)	18.7
Net Weight (kg)	13.848
Base color options	White, Black
Warranty Period	10 years

Pattern No.	Color	Contract Price	Lead Time
Made-To-Order			
MSTLCTR3026380-BLCK-BLCK	Black Linoleum/Anthracite Black	USD 975.00	-
MSTLCTR3026380-WHIT-BLCK	Black Linoleum/White	USD 975.00	-
Made-To-Order			
MSTLCTR302638N-BLCK-BLCK	Black Nanolaminate/Anthracite Black	USD 975.00	-
MSTLCTR302638N-WHIT-BLCK	Black Nanolaminate/White	USD 975.00	-
MSTLCTR302638N-BLCK-WHIT	White Nanolaminate/Anthracite Black	USD 975.00	-
MSTLCTR302638N-WHIT-WHIT	White Nanolaminate/White	USD 975.00	-
Extras			
70705	70705	USD 23.00	-

STILL CAFÉ TABLE / 75 X 65 H: 105 CM / 29.5 X 25.6 H: 41.3"

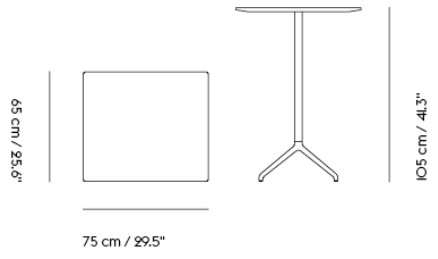

- Shipper Colli 2
- Gross Weight (kg) 19.05
- Net Weight (kg) 14.198
- Base color options White, Black
- Warranty Period 10 years

Pattern No.	Color	Contract Price	Lead Time
Ready-To-Ship US Warehouse			
MSTLCTR302641N-BLCK-BLCK	Black Nanolaminate/Anthracite Black	USD 975.00	-
MSTLCTR302641N-WHIT-BLCK	Black Nanolaminate/White	USD 975.00	-
MSTLCTR302641N-BLCK-WHIT	White Nanolaminate/Anthracite Black	USD 975.00	-
MSTLCTR302641N-WHIT-WHIT	White Nanolaminate/White	USD 975.00	-
Made-To-Order			
MSTLCTR302641O-BLCK-BLCK	Black Linoleum/Anthracite Black	USD 975.00	-
MSTLCTR302641O-WHIT-BLCK	Black Linoleum/White	USD 975.00	-
Extras			
70705	70705	USD 23.00	-

VARIANTS MARKED WITH *** WILL BE MADE-TO-ORDER OR DISCONTINUED WHEN OUT OF STOCK FOR MORE INFORMATION VISIT MUUTO.COM

STILL CAFÉ TABLE / Ø 75 H: 73 CM / Ø 29.5 H: 28.7"

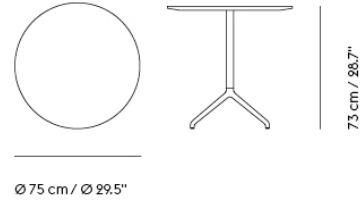

Shipper Colli	2
Gross Weight (kg)	17.1
Net Weight (kg)	12.152
Base color options	Black, White
Warranty Period	10 years

Pattern No.	Color	Contract Price	Lead Time
Ready-To-Ship US Warehouse			
MSTLCTO3029N-BLCK-BLCK	Black Nanolaminate/Anthracite Black	USD 923.00	-
MSTLCTO3029N-WHIT-BLCK	Black Nanolaminate/White	USD 923.00	-
MSTLCTO3029N-BLCK-WHIT	White Nanolaminate/Anthracite Black	USD 923.00	-
MSTLCTO3029N-WHIT-WHIT	White Nanolaminate/White	USD 923.00	-
Made-To-Order			
MSTLCTO30290-BLCK-BLCK	Black Linoleum/Anthracite Black	USD 923.00	-
MSTLCTO30290-WHIT-BLCK	Black Linoleum/White	USD 923.00	-
Extras			
70705	70705	USD 23.00	-

STILL CAFÉ TABLE / Ø 75 H: 95 CM / Ø 29.5 H: 37.4"

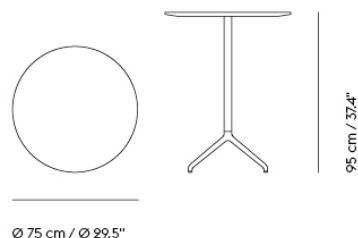

Shipper Colli	2
Gross Weight (kg)	17.5
Net Weight (kg)	12.648
Base color options	Black, White
Warranty Period	10 years

Pattern No.	Color	Contract Price	Lead Time
Made-To-Order			
MSTLCTO30380-BLCK-BLCK	Black Linoleum/Anthracite Black	USD 975.00	-
MSTLCTO30380-WHIT-BLCK	Black Linoleum/White	USD 975.00	-
Made-To-Order			
MSTLCTO3038N-BLCK-BLCK	Black Nanolaminate/Anthracite Black	USD 975.00	-
MSTLCTO3038N-WHIT-BLCK	Black Nanolaminate/White	USD 975.00	-
MSTLCTO3038N-BLCK-WHIT	White Nanolaminate/Anthracite Black	USD 975.00	-
MSTLCTO3038N-WHIT-WHIT	White Nanolaminate/White	USD 975.00	-
Extras			
70705	70705	USD 23.00	-

STILL CAFÉ TABLE / Ø 75 H: 105 CM / Ø 29.5 H: 41.3"

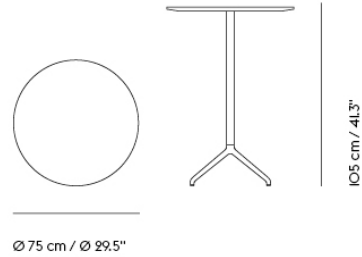

Shipper Colli	2
Gross Weight (kg)	17.85
Net Weight (kg)	12.998
Base color options	Black, White
Warranty Period	10 years

Pattern No.	Color	Contract Price	Lead Time
Ready-To-Ship US Warehouse			
MSTLCTO3041N-BLCK-BLCK	Black Nanolaminate/Anthracite Black	USD 975.00	-
MSTLCTO3041N-WHIT-BLCK	Black Nanolaminate/White	USD 975.00	-
MSTLCTO3041N-BLCK-WHIT	White Nanolaminate/Anthracite Black	USD 975.00	-
MSTLCTO3041N-WHIT-WHIT	White Nanolaminate/White	USD 975.00	-
Made-To-Order			
MSTLCTO3041O-BLCK-BLCK	Black Linoleum/Anthracite Black	USD 975.00	-
MSTLCTO3041O-WHIT-BLCK	Black Linoleum/White	USD 975.00	-
Extras			
70705	70705	USD 23.00	-

STILL CAFÉ TABLE / Ø 65 H: 73 CM / Ø 25.6 H: 28.7"

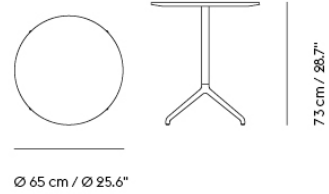

Shipper Colli 2
Gross Weight (kg) 14.7
Net Weight (kg) 10.152
Base color options Black, White
Warranty Period 10 years

Pattern No.	Color	Contract Price	Lead Time
Made-To-Order			
MSTLCTO26290-BLCK-BLCK	Black Linoleum/Anthracite Black	USD 923.00	-
MSTLCTO26290-WHIT-BLCK	Black Linoleum/White	USD 923.00	-
Made-To-Order			
MSTLCTO2629N-BLCK-BLCK	Black Nanolaminate/Anthracite Black	USD 923.00	-
MSTLCTO2629N-WHIT-BLCK	Black Nanolaminate/White	USD 923.00	-
MSTLCTO2629N-BLCK-WHIT	White Nanolaminate/Anthracite Black	USD 923.00	-
MSTLCTO2629N-WHIT-WHIT	White Nanolaminate/White	USD 923.00	-
Extras			
70705	70705	USD 23.00	-

STILL CAFÉ TABLE / Ø 65 H: 95 CM / Ø 25.6 H: 37.4"

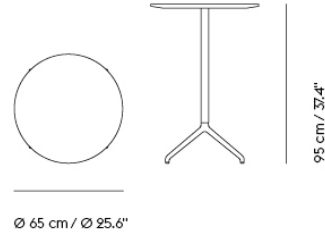

Shipper Colli 2
Gross Weight (kg) 15.1
Net Weight (kg) 10.648
Base color options Black, White
Warranty Period 10 years

Pattern No.	Color	Contract Price	Lead Time
Made-To-Order			
MSTLCTO26380-BLCK-BLCK	Black Linoleum/Anthracite Black	USD 975.00	-
MSTLCTO26380-WHIT-BLCK	Black Linoleum/White	USD 975.00	-
Made-To-Order			
MSTLCTO2638N-BLCK-BLCK	Black Nanolaminate/Anthracite Black	USD 975.00	-
MSTLCTO2638N-WHIT-BLCK	Black Nanolaminate/White	USD 975.00	-
MSTLCTO2638N-BLCK-WHIT	White Nanolaminate/Anthracite Black	USD 975.00	-
MSTLCTO2638N-WHIT-WHIT	White Nanolaminate/White	USD 975.00	-
Extras			
70705	70705	USD 23.00	-

STILL CAFÉ TABLE / Ø 65 H: 105 CM / Ø 25.6 H: 41.3"

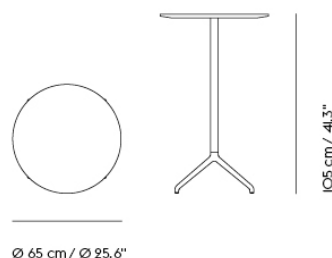

Shipper Colli	2
Gross Weight (kg)	15.45
Net Weight (kg)	10.998
Base color options	Black, White
Warranty Period	10 years

Pattern No.	Color	Contract Price	Lead Time
Made-To-Order			
MSTLCTO26410-BLCK-BLCK	Black Linoleum/Anthracite Black	USD 975.00	-
MSTLCTO26410-WHIT-BLCK	Black Linoleum/White	USD 975.00	-
Made-To-Order			
MSTLCTO2641N-BLCK-BLCK	Black Nanolaminate/Anthracite Black	USD 975.00	-
MSTLCTO2641N-WHIT-BLCK	Black Nanolaminate/White	USD 975.00	-
MSTLCTO2641N-BLCK-WHIT	White Nanolaminate/Anthracite Black	USD 975.00	-
MSTLCTO2641N-WHIT-WHIT	White Nanolaminate/White	USD 975.00	-
Extras			
70705	70705	USD 23.00	-

VISU CHAIR SERIES

"The idea for the Visu Chair Family was to create an elegantly simple interpretation of the archetypal plywood chair. I wanted for the design to have a subdued and timeless character that would add feelings of modern familiarity to any room together with a comfortable seat in form-pressed veneer. Designing the chair as a family that were all aesthetically linked yet could be used for different functions was a study in adapting a design to its surroundings and a process that lasted nearly two years. The Visu Chair Family is a new perspective on the traditional wooden chair, echoing the ideas of Scandinavian design together with a modern expression."

— Mika Tolvanen



Designed by	Mika Tolvanen
Environment	Indoor
Country of Production	Latvia
Assembly Required	No
Description	Bringing lightness into design, the Visu Series combines ergonomic and functional expressions with a quiet silhouette.
Material	<p>Non-upholstered Oak version: Form-pressed veneer shell in water-based lacquer.</p> <p>Non-upholstered colored versions: Shell in form-pressed veneer shell in water-based lacquer.</p> <p>Upholstered version: Shell is made in form-pressed veneer with foam and fully upholstered with textile or leather. Wood Base is form-pressed in veneer with a water-based lacquer. Sled Base in powder coated steel. Swivel Base in die casted aluminum. Swivel foot is casted in one piece. Option of pre-mounted felt glides upon request for orders above 50 chairs.</p>
Cleaning & Care	Clean on a regular basis using a damp and clean cloth. Remove stains using a mild mixture of water and detergent. Avoid contact with sharp objects as these can leave scratches in the wood and lacquer. For textile upholstery versions, please find specific cleaning instructions for your chosen textile at kvadrat.dk. For leather versions, clean leather with a dry cloth regularly. Treat the leather when needed using only special leather treatment products.
Made-To-Order	Visu Chair w. Tube Base and Visu Chair w. Sled Base including Linking Device is only available as made-to-order. The Linking Device can only be mounted by the supplier and therefore must be purchased as a spare part in combination with a chair.

VISU CHAIR SERIES

<p>Chair Counter & Bar Stool Wide Chair Lounge Chair</p>	<p>CUSTOMIZED UPHOLSTERY Textile upholstery: 0,94 m / 1.1 yds — Leather upholstery: 1,54 m² / 16.6 ft² Textile upholstery: 0,73 m / 0.8 yds — Leather upholstery: 1,21 m² / 13.1 ft² Textile upholstery: 1,21 m / 1.3 yds — Leather upholstery: 2,42 m² / 26.1 ft² Textile Upholstery: 1,57 m / 1.72 yds — Leather Upholstery: 3,01 m² / 32.4 ft²</p>
<p>EN 16139:2013 - L2</p>	<p>TESTS & CERTIFICATIONS Extreme use. Furniture - Strength, durability and safety. Requirements for non-domestic seating.</p>
<p>EN 1022:2005</p>	<p>Domestic furniture - Seating - Determination of stability.</p>
<p>ANSI/BIFMA X5.4-2020</p>	<p>Visu Chair with Sled Base: American National Standard for Office Furnishings. Lounge and public seating.</p>
<p>Declare.</p>	<p>Visu Chair Series without upholstery and EU/US versions upholstered with a large selection of Kvadrat textiles¹ are Living Building Challenge Red List Approved as part of Muuto's participation in Declare.</p>
<p>VOC CDPH 01350 & VOC BIFMA X7.1.</p>	<p>Visu Chair Series, without upholstery and EU/US versions upholstered with Easy and Refine Leather and a large selection of Kvadrat textiles¹ are tested to VOC CDPH 01350 and VOC BIFMA X7.1.</p>
<p>Global GreenTag Green- Rate™</p>	<p>Visu Chair Series without upholstery and EU/US versions upholstered with Easy and Refine Leather and a large selection of Kvadrat textiles² is Global GreenTag Green-Rate Level C-certified. <i>Please note: The Global GreenTag Label only applies for contract market orders with a minimum 5-year warranty.</i></p>

¹Upholstered Muuto products that have the Declare Living Building Challenge Red List Approved certification only have the certification when upholstered with the following Kvadrat textiles: Balder, Canvas, Clara, Clay, Divina, Divina MD, Divina mélange, Fiord, Hallingdal, Hero, Remix, Re-wool, Steelcut, Steelcut Trio, Vidar, Twill weave.

²Upholstered EU/US versions of Cover Armchair, Cover Lounge Chair and Cover Side Chair only have the GreenTag certificate when upholstered with the following Kvadrat textiles: Canvas, Clara, Divina, Divina MD, Divina melange, Fiord, Hallingdal, Hero, Remix, Re-wool, Steelcut, Steelcut trio, Twill Weave, Vidar.

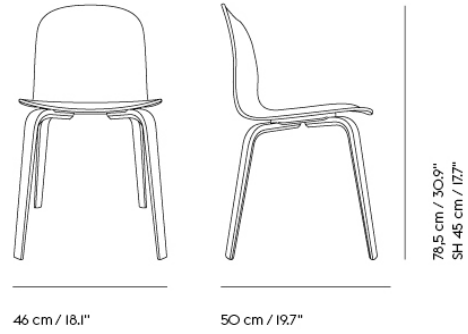

Shipper Colli	1
Gross Weight (kg)	10.2
Net Weight (kg)	4.6125
Base color options	Black, Dark Green, Dusty Green, Grey, Midnight Blue, Oak, Sand or Tan Rose
Warranty Period	5 years

Pattern No.	Color	Contract Price	Lead Time
Ready-To-Ship US Warehouse			
MVISCWODW-BLCK-BLCK	Black/Black	USD 467.00	-
MVISCWODW-DGRN-DGRN	Dusty Green/Dusty Green	USD 467.00	-
MVISCWODW-OAK-OAK	Oak/Oak	USD 467.00	-
MVISCWODW-OAK-WHIT	White/Oak	USD 467.00	-
Ready-To-Ship EU Warehouse			
MVISCWODW-DKGN-DKGN	Dark Green/Dark Green	USD 467.00	-
MVISCWODW-MBLU-MBLU	Midnight Blue/Midnight Blue	USD 467.00	-
MVISCWODW-SAND-SAND	Sand/Sand	USD 467.00	-
MVISCWODW-TROS-TROS	Tan Rose/Tan Rose	USD 467.00	-
Extras			
MGLDVWDFG4	Felt glides for Visu Wood Base (4 pcs per pack) - Grey	USD 21.00	-
MGLDVWDFB4	Felt glides for Visu Wood Base (4 pcs per pack) - Black	USD 21.00	-
MGLDVWDPB4	Plastic Glides for Visu Wood Base (4 pcs per pack) - Black	USD 21.00	-
MLEAKIT	Leather care set for Refine Leather	USD 27.00	-

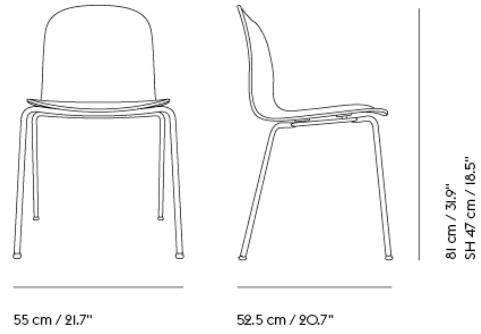

Shipper Colli	1
Gross Weight (kg)	13.5
Net Weight (kg)	5.75
Base color options	Black, Chrome or Grey
Stacking information	Stacking on Trolley: Without upholstery: 17 - With upholstery: 15. Stacking on floor: Without upholstery: 15 - With upholstery: 10.
Warranty Period	10 years

Pattern No.	Color	Contract Price	Lead Time
Ready-To-Ship EU Warehouse			
MVISCTUBW-BLCK-BLCK	Black/Black	USD 394.00	-
Extras			
MGLDOFVTBPB1	Plastic glides for Oslo, Fiber and Visu with Tube Base (1 pc per pack) - Black	USD 6.00	-
MGLDOFVTBFB4	Felt Glides for Oslo, Fiber and Visu with Tube Base (4 pcs per pack)	USD 21.00	-
MCHVST	Chair Hanger for Visu Chair (Sled + Tube base)	USD 93.00	>MOQ: 50 13-15 weeks

VISU CHAIR SLED BASE

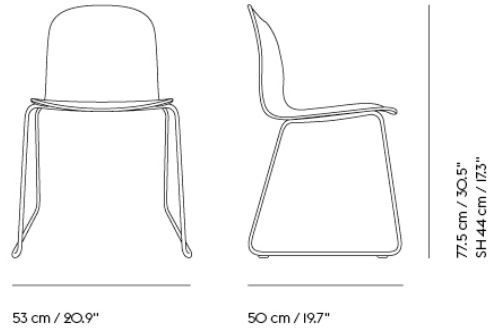

Shipper Colli	1
Gross Weight (kg)	13.5
Net Weight (kg)	5.75
Base color options	Black, Grey or White
Stacking information	Stacking on Trolley: Without upholstery: 17 - With upholstery: 15. Stacking on floor: Without upholstery: 15 - With upholstery: 10
Warranty Period	10 years

Pattern No.	Color	Contract Price	Lead Time
-------------	-------	----------------	-----------

Ready-To-Ship US Warehouse

MVISCSLDW-BLCK-BLCK	Black/Black	USD 394.00	-
MVISCSLDW-GREY-GREY	Grey/Grey ***	USD 394.00	-
MVISCSLDW-WHIT-WHIT	White/White ***	USD 394.00	-

Extras

80101	Clear	USD 6.00	-
MGLDFVSDFT1	Felt Glides for Fiber and Visu with Sled Base (1 pc per pack)	USD 6.00	-
MLDVSLD	Linking Device for Visu Chair Sled Base	USD 48.00	>MOQ: 8 13-15 weeks
MCHVST	Chair Hanger for Visu Chair (Sled + Tube base)	USD 93.00	>MOQ: 50 13-15 weeks

COVER AND VISU CHAIR TRANSPORT TROLLEY

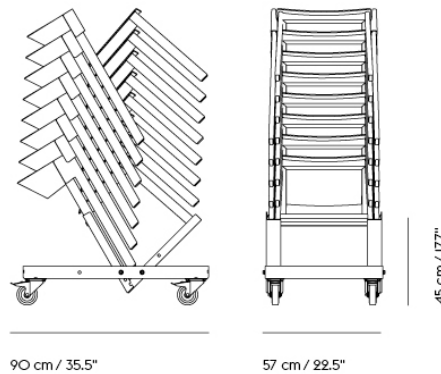

Shipper Colli	1
Gross Weight (kg)	22
Net Weight (kg)	21.5
Please note	This transport trolley can be used for Visu Chair Tube Base, Visu Chair Sled Base and Cover Side Chair.
Stacking information	Stacking on Trolley: Without upholstery: 17. With upholstery: 15. With linking device: 15 Stacking on floor: Without upholstery: 15. With upholstery: 10. With linking device: 8. Cover Side Chair: 4 on floor and 10 on trolley.
Warranty Period	5 years

Pattern No.	Color	Contract Price	Lead Time
Ready-To-Ship US Warehouse			
MTTCV	Black	USD 971.00	-

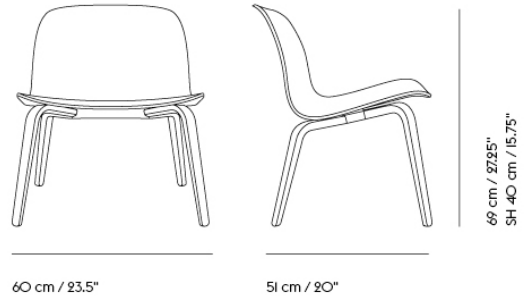

Shipper Colli	1
Gross Weight (kg)	11.5
Net Weight (kg)	9.224
Base color options	Black, Dusty Green, Grey or Oak
Warranty Period	5 years

Pattern No.	Color	Contract Price	Lead Time
Ready-To-Ship US Warehouse			
MVISLW-BLCK-BLCK	Black/Black	USD 667.00	-
MVISLW-GREY-GREY	Grey/Grey - PU Lacquer	USD 667.00	-
MVISLW-OAK-OAK	Oak/Oak	USD 667.00	-
MVISLU-OAK-M155991	Fiord 991/Oak	USD 1,024.00	-
MVISLU-GREY-M4586108	Re-wool 108/ Grey	USD 1,024.00	-
MVISLU-OAK-M136COGN	Refine Leather Cognac/Oak	USD 1,675.00	-
Ready-To-Ship EU Warehouse			
MVISLW-DGRN-DGRN	Dusty Green/Dusty Green	USD 667.00	-
Extras			
MGLDVWDFG4	Felt glides for Visu Wood Base (4 pcs per pack) - Grey	USD 21.00	-
MGLDVWDPB4	Plastic Glides for Visu Wood Base (4 pcs per pack) - Black	USD 21.00	-
MLEAKIT	Leather care set for Refine Leather	USD 27.00	-

VISU COUNTER STOOL WOOD BASE - 65 CM / 25.6"

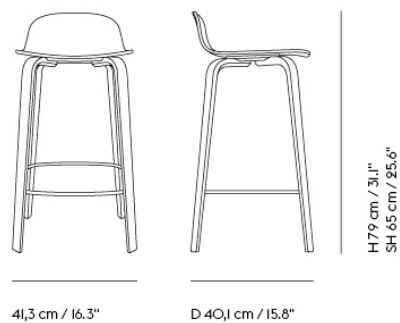
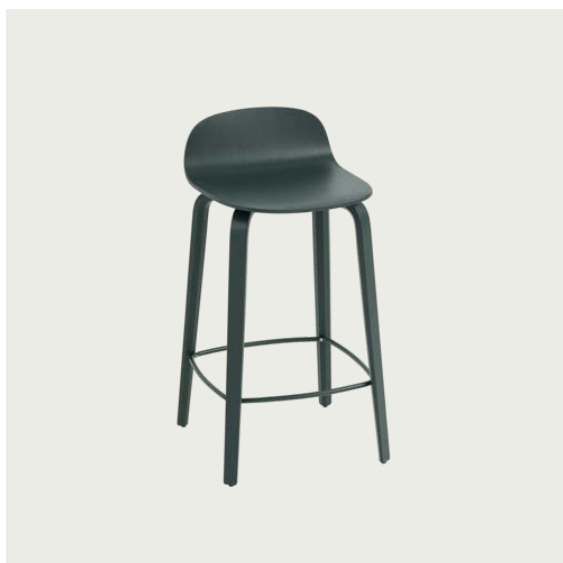

Shipper Colli	1
Gross Weight (kg)	5.6
Net Weight (kg)	4.08
Base color options	Black, Dark Green, Grey, Oak or Tan Rose
Warranty Period	5 years

Pattern No.	Color	Contract Price	Lead Time
Ready-To-Ship US Warehouse			
MVISSTCW-BLCK-BLCK	Black/Black	USD 719.00	-
MVISSTCW-GREY-GREY	Grey/Grey	USD 719.00	-
MVISSTCW-OAK-OAK	Oak/Oak	USD 719.00	-
Ready-To-Ship EU Warehouse			
MVISSTCW-OAK-WHIT	White/Oak	USD 719.00	-
Extras			
MGLDVWDFG4	Felt glides for Visu Wood Base (4 pcs per pack) - Grey	USD 21.00	-
MGLDVWDPB4	Plastic Glides for Visu Wood Base (4 pcs per pack) - Black	USD 21.00	-
MLEAKIT	Leather care set for Refine Leather	USD 27.00	-

VISU BAR STOOL WOOD BASE - 75 CM / 29.5"

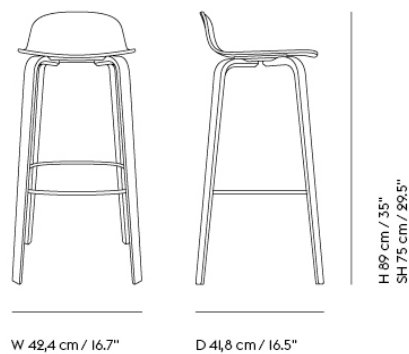

Shipper Colli	1
Gross Weight (kg)	5.7
Net Weight (kg)	4.18
Base color options	Black, Dark Green, Grey, Oak or Tan Rose
Warranty Period	5 years

Pattern No.	Color	Contract Price	Lead Time
Ready-To-Ship US Warehouse			
MVISSTBW-BLCK-BLCK	Black/Black	USD 719.00	-
MVISSTBW-GREY-GREY	Grey/Grey	USD 719.00	-
MVISSTBW-OAK-OAK	Oak/Oak ***	USD 719.00	-
MVISSTBW-TROS-TROS	Tan Rose/Tan Rose	USD 719.00	-
Ready-To-Ship EU Warehouse			
MVISSTBW-OAK-WHIT	White/Oak	USD 719.00	-
Extras			
MGLDVWDFG4	Felt glides for Visu Wood Base (4 pcs per pack) - Grey	USD 21.00	-
MGLDVWDPB4	Plastic Glides for Visu Wood Base (4 pcs per pack) - Black	USD 21.00	-
MLEAKIT	Leather care set for Refine Leather	USD 27.00	-

VISU CHAIR WOOD BASE & VISU LOUNGE CHAIR



46 cm / 18"



51 cm / 20"

78,5 cm / 31"
SH 46 cm / 18"

60 cm / 23.5"



51 cm / 20"

69 cm / 27.25"
SH 40 cm / 15.75"

All Upholstery Variants

Description	Pattern No.	Upholstery Grades									
		A	B	C	E	R	T	U	V	W	
Visu Chair Wood Base	Upholstered Seat	M-VISC-WOD-U	719	786	849	881	933	1,101	1,045	1,416	1,570
Visu Lounge Chair	Upholstered Seat	M-VISL-U	919	1,024	1,101	1,150	1,626	1,675	1,675	2,361	2,515

HOW TO CONFIGURE

Specify:

- Step 1) Choose variant
Step 2) Choose base color
Step 3) Choose textile
Step 4) Choose textile color

ORDER CODE EXAMPLE:

Visu Lounge Chair upholstered in beige Endure Leather

Variant: Visu Lounge Chair
Base color: Oak
Upholstery option: Endure Leather
Upholstery color: Beige
Final Pattern No: MVISLUOAKM137BEIG

Base Color Options

Visu Chair - wood base:
OAK - Oak
BLCK - Black
GREY - Grey
DKGN - Dark Green
TROS - Tan Rose

Visu Lounge Chair - wood base:
OAK - Oak
BLCK - Black
GREY - Grey
DGRN - Dusty Green

Upholstery Options

A	B	C	E	R	T	U	V	W
Ocean (M161)* Remix (M156)	Canvas (M153) Clara (M154) Colline (M5416) Fiord (M155) Grain (M12659) Manner (M12665) Re-Wool (4586) Sabi (M8404) Steelcut (M149) Steelcut Trio (M139)	Hallingdal (M146)	Acca (M12660) Balder (M152) Beck (M6376) Divina (M150) Divina MD (M147) Divina Melange (M135) Ecriture (M01767) Hearth (M12664) Planum (M5904) Twill Weave (M142)	Easy Leather (M141)	Refine Leather (M136)	Endure Leather (M137)	Grace Leather (M12374)	Allure Leather (M12375)

*Notes:
*Ocean: Color 3, 21, 32, 50, 52, 80 & 601

VISU CHAIR TUBE & SLED BASE



78 cm / 30.75"
SH 46 cm / 18"

53,5 cm / 21"

50 cm / 19.75"



78 cm / 30.75"
SH 46 cm / 18"

53,5 cm/21"

48 cm / 19"

All Variants

	Description	Pattern No.	W1	Upholstery Grades				
				A	COM B	CIL C	E	R
Visu Chair Tube Base	Wood Seat	M-VISC-TUB-W	394					
	Upholstered Seat	M-VISC-TUB-U		576	614	681	719	776
Visu Chair Tube Base w Linking Device	Wood Seat	M-VISC-TUB-W-LD	440					
	Upholstered Seat	M-VISC-TUB-U-LD		625	660	730	772	824
Visu Chair Sled Base	Wood Seat	M-VISC-SLD-W	394					
	Upholstered Seat	M-VISC-SLD-U		562	614	681	719	776
Visu Chair Sled Base w Linking Device	Wood Seat	M-VISC-SLD-W-LD	440					
	Upholstered Seat	M-VISC-SLD-U-LD		625	660	730	772	824

HOW TO CONFIGURE

ORDER CODE EXAMPLE:

Specify:

Visu Chair Black Sled Base upholstered in Divina Melange 277

- Step 1) Choose variant
- Step 2) Choose base color
- Step 3) Choose textile
- Step 4) Choose textile color

Variant: Visu Chair Sled Base
 Base color: Black
 Upholstery option: Endure Leather
 Upholstery color: 277
 Final Pattern No: MVISCSLDUBLCKM135277

Base Color Options

Shell Color Options

When ordering wood shell version

Tube base
 BLCK - Black
 GREY - Grey
 CHRO - Chrome

Tube base
 OAK - Oak (W1)
 BLCK - Black (W1)
 GREY - Grey (W1)

Base and wood shell can be combined as follows
 Tube Base
 BLCK/BLCK - Black/Black Shell
 BLCK/STDB - Black/Stained Dark Brown
 GREY/GREY - Grey/Grey Shell
 CHRO/OAK - Chrome/Oak Shell

Sled base
 BLCK - Black
 GREY - Grey
 WHIT - White

Sled base
 WHIT - White (W1)
 BLCK - Black (W1)

Sled base
 BLCK/BLCK - Black/Black Shell
 BLCK/STDB - Black/Stained Dark Brown
 GREY/GREY - Grey/Grey Shell
 WHIT/WHIT - White/White Shell

Upholstery Options

A	B	C	E	R
Ocean (M161)* Remix (M156)	Canvas (M153) Clara (M154) Colline (M5416) Fiord (M155) Grain (M12659) Manner (M12665) Re-Wool (4586) Sabi (M8404) Steelcut (M149) Steelcut Trio (M139)	Hallingdal (M146)	Acca (M12660) Balder (M152) Beck (M6376) Divina (M150) Divina MD (M147) Divina Melange (M135) Ecriture (M01767) Hearth (M12664) Planum (M5904) Twill Weave (M142)	Easy Leather (M141)

*Notes:
 *Ocean: Color 3, 21, 32, 50, 52, 80 & 601

VISU WIDE CHAIR WOOD & SWIVEL BASE

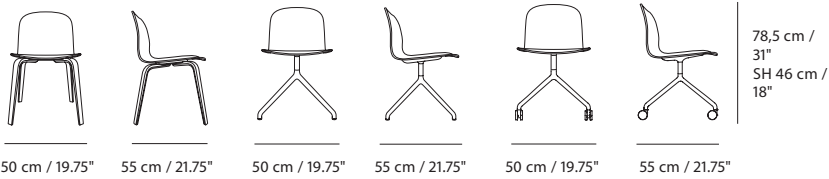

Wood base:
Gross Weight (kg) 4.9
Net Weight (kg) 4.6
Warranty Period 5 years

Swivel base & Swivel base w/castors:
Gross Weight (kg) 7.8
Net Weight (kg) 7.6
Warranty Period 5 years

All Variants

	Description	Pattern No.	W1	Upholstery Grades			COM						
				A	B	C	E	R	COL				
Visu Wide Chair Wood	Wood Seat	M-VISWC-WOD-W	541										
Base	Upholstered Seat	M-VISWC-WOD-U		807	881	933	971	1,024	1,150	1,206	1,836	2,046	
Visu Wide Chair Swivel	Wood Seat	M-VISWC-SWB-W	702										
Base	Upholstered Seat	M-VISWC-SWB-U		971	1,101	1,101	1,150	1,255	1,311	1,360	2,046	2,256	
Visu Wide Chair Swivel	Wood Seat	M-VISWC-SWR-W	776										
Base w. Return	Upholstered Seat	M-VISWC-SWR-U		1,045	1,150	1,206	1,206	1,311	1,311	1,416	2,046	2,256	
Visu Wide Chair Swivel	Wood Seat	M-VISWC-SWC-W	776										
Base w. Castors	Upholstered Seat	M-VISWC-SWC-U		1,045	1,150	1,206	1,206	1,255	1,416	1,416	2,095	2,305	

HOW TO CONFIGURE

ORDER CODE EXAMPLE:

Specify:

Visu Chair Black Sled Base upholstered in Divina Melange 277

Step 1) Choose Variant
Step 2) Base color
Step 3) Textile
Step 4) Textile color

Variant: Visu Chair Sled Base
Base Color: Black
Upholstery option: Endure Leather
Upholstery Color: 277
Final Pattern No.: MVISCSLDUBLCKM135277

Base Color Options

Shell Color Options

When ordering wood shell version

Swivel base & Swivel base w. Return
BLCK - Black

OAK - Oak (W1)
BLCK - Black (W1)

Base and Shell can be combined as follows
Wood base
OAK/OAK - Oak/Oak Shell
BLCK/BLCK - Black/Black Shell

Swivel base w. Castors
BLCK - Black with black castors

Wood base:
OAK - Oak
BLCK - Black

All Swivel bases
BLCK/BLCK - Black/Black Shell
BLCK/OAK - Black/Oak Shell

Upholstery Options

A	B	C	E	R	T	U	V	W
Ocean (M161)* Remix (M156)	Canvas (M153) Clara (M154) Colline (M5416) Fiord (M155) Grain (M12659) Manner (M12665) Re-Wool (4586) Sabi (M8404) Steelcut (M149) Steelcut Trio (M139)	Hallingdal (M146)	Acca (M12660) Balder (M152) Beck (M6376) Divina (M150) Divina MD (M147) Divina Melange (M135) Ecriture (M01767) Hearth (M12664) Planum (M5904) Twill Weave (M142)	Easy Leather (M141)	Refine Leather (M136)	Endure Leather (M137)	Grace Leather (M12374)	Allure Leather (M12375)

*Notes:
Ocean - Color 3, 21, 32, 50, 52, 80 & 601

VISU COUNTER & BAR STOOLS



All Upholstery Variants

Description	Pattern No.	Upholstery Grades									
		A	COM		CIL			COL			
			B	C	E	R	T	U	V	W	
Visu Counter Upholstered Seat	M-VISST-C-U	866	902	1,013	995	1,045	1,101	1,101	1,465	1,570	
Visu Bar Stool Upholstered Seat	M-VISST-B-U	866	902	1,013	995	1,045	1,101	1,101	1,465	1,570	

HOW TO CONFIGURE

ORDER CODE EXAMPLE:

<p>Specify:</p> <p>Step 1) Choose variant</p> <p>Step 2) Choose color</p> <p>Step 3) Choose Textile</p> <p>Step 4) Choose Textile color</p>	<p>Visu Counter Stool upholstered in beige Endure Leather</p> <p>Variant: Visu Counter Stool</p> <p>Base Color: Oak</p> <p>Upholstery option: Endure Leather</p> <p>Upholstery Color: Beige</p> <p>Final Pattern No: MVISSTCUOAKM137BEIG</p>
---	--

Base Color Options

- OAK - Oak
- STDB - Stained Dark Brown
- BLCK - Black
- GREY - Grey
- DKGN - Dark Green
- TROS - Tan Rose

Upholstery Options

A	B	C	E	R	T	U	V	W
Ocean (M161)* Remix (M156)	Canvas (M153) Clara (M154) Colline (M5416) Fiord (M155) Grain (M12659) Manner (M12665) Re-Wool (4586) Sabi (M8404) Steelcut (M149) Steelcut Trio (M139)	Hallingdal (M146)	Acca (M12660) Balder (M152) Beck (M6376) Divina (M150) Divina MD (M147) Divina Melange (M135) Ecriture (M01767) Hearth (M12664) Planum (M5904) Twill Weave (M142)	Easy Leather (M141)	Refine Leather (M136)	Endure Leather (M137)	Grace Leather (M12374)	Allure Leather (M12375)

*Notes:
Ocean - Color 3, 21, 32, 50, 52, 80 & 601

WORKSHOP SERIES

“The Workshop Series is design when pared down to the essence. Deliberately simple in its expression, the designs have an almost archetypal appearance that comes from a wish to make as little noise as possible—the details and joints are doing all the talking.”

— Cecilie Manz



Designed by	Cecilie Manz
Environment	Indoor
Country of Production	Chair, Bench & Coffee Table in Oak Veneer: Latvia Coffee Table in Linoleum & Tables: Denmark
Assembly Required	Chair: No Bench: No Table: Yes Coffee Table in Linoleum: Yes Coffee Table in Oak Veneer: No
Description	The Workshop Series joins together the ideals of Scandinavian craftsmanship and subtle detailing for a deliberately simple and archetypal expression.
Material	<p>Chair: Seat and back in water-based lacquered shape pressed layer glued veneer. Frame and legs in water-based lacquered solid wood.</p> <p>Bench: Frame and legs in solid oak, seat and back in form pressed oak veneer — all parts in FSC™-certified (FSC-CO28824) wood coated with a water-based lacquer. Plastic glides. Oak veneer: slight color variations may occur due to the inherent characteristics of the material.</p> <p>Coffee Table: Frame and legs are made from lacquered solid oak. Black version comes in water-based lacquered oak. Oak version comes with a matte clear water-based lacquer. Table top with a lacquered oak veneer or linoleum finish.</p> <p>Table: Tabletop in lineoleum or oak veneer with a PU-lacquer. Legs and frame in solid oak with a PU-lacquer.</p>
Cleaning & Care	<p>Clean with a damp cloth. If necessary, only use a mild detergent or washing up liquid and not concentrated. Always wipe with a dry cloth afterwards. To minimize the risk of stains and marks, liquid, grease etc. should be removed straight away. For linoleum versions it is recommended to use a linoleum polish on the surface when needed.</p> <p>Bench: Wipe off with moist cloth and remove excess liquid with dry cloth. The Workshop Bench can be cleaned with alcohol disinfectant. However, please note that wooden products will get patina where the surface color can slightly fade. If cleaning is uneven, this may become even more apparent, yet the lacquer will stay in place. For wooden products in lighter colors, the patina will be less apparent.</p>

	TESTS & CERTIFICATIONS*
EN 15372:2016-L3	Extreme use. Furniture – Strength, durability and safety. Requirements for non-domestic tables.
ANSI/BIFMA X5.5-2021	American National Standard For Office. Furnishings - Desk products.
EN 16139:2013 - L1	Workshop Bench: General use. Furniture - Strength, durability and safety Requirements for non-domestic seating.
EN 16139:2013 - L2	Workshop Chair & Bench: Extreme use. Furniture - Strength, durability and safety. Requirements for non-domestic seating.
EN 1022:2005	Workshop Chair & Bench: Domestic furniture - Seating - Determination of stability. <i>Please note: this test does not apply to Workshop Chair in Oregon Pine</i>
VOC CDPH 01350 & VOC BIFMA X7.1.	Workshop Chair and Bench is tested to VOC CDPH 01350 and VOC BIFMA X7.1.
Forest Stewardship Council™	Workshop Bench is made using FSC™-certified (FSC-CO28824) wood.

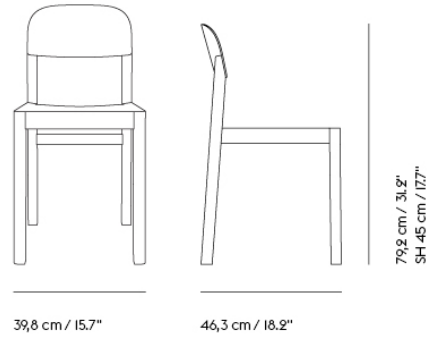

Shipper Colli I
Gross Weight (kg) II
Net Weight (kg) 5.095
Warranty Period 5 years

Pattern No.	Color	Contract Price	Lead Time
Ready-To-Ship US Warehouse			
MWRKCW-BLCK	Black	USD 597.00	-
MWRKCW-OAK	Oak	USD 597.00	-
Extras			
MGLDNSWCFB4	Felt glides for Nerd Series and Workshop Chair and Bench (4 pcs per pack) - Black	USD 21.00	-
MGLDNSWCFG4	Felt glides for Nerd Series and Workshop Chair and Bench (4 pcs per pack) - Grey	USD 21.00	-

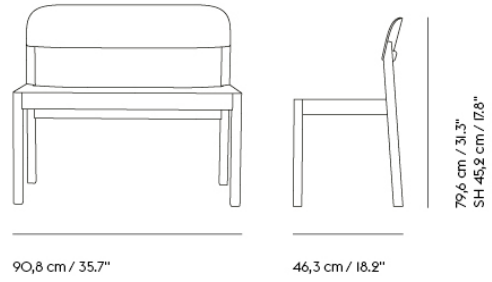

Shipper Colli 1
Gross Weight (kg) 12.76
Net Weight (kg) 9.49
Warranty Period 5 years

Pattern No.	Color	Contract Price	Lead Time
Ready-To-Ship EU Warehouse			
MWRKBW-BLCK	Black	USD 1,360.00	-
MWRKBW-OAK	Oak	USD 1,360.00	-
Extras			
MGLDNSWCFB4	Felt glides for Nerd Series and Workshop Chair and Bench (4 pcs per pack) - Black	USD 21.00	-
MGLDNSWCFG4	Felt glides for Nerd Series and Workshop Chair and Bench (4 pcs per pack) - Grey	USD 21.00	-

WORKSHOP TABLE / 130 X 65 CM / 51 X 25.5"

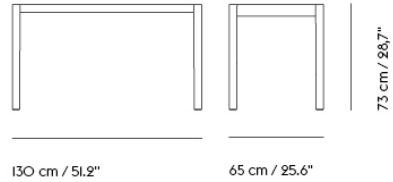

Shipper Colli 1
Gross Weight (kg) 26.25
Net Weight (kg) 22.5
Warranty Period 10 years

Pattern No.	Color	Contract Price	Lead Time
Ready-To-Ship US Warehouse			
MWRKDT5126-BLCK-BLCK	Black Linoleum/Black	USD 2,256.00	-
MWRKDT5126-WMGY-OAK	Warm Grey Linoleum/Oak	USD 2,256.00	-
Extras			
70706	70706	USD 23.00	-

WORKSHOP TABLE / 140 X 92 CM / 55.1 X 36.2"

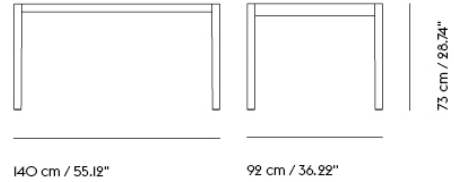

Shipper Colli 1
 Gross Weight (kg) 30
 Net Weight (kg) 25.95
 Warranty Period 10 years

Pattern No.	Color	Contract Price	Lead Time
Ready-To-Ship EU Warehouse			
MWRKDT5536-OAK	Oak Veneer/Oak	USD 2,781.00	-
MWRKDT5536-BLCK-BLCK	Black Linoleum/Black	USD 2,571.00	-
MWRKDT5536-WMGY-OAK	Warm Grey Linoleum/Oak	USD 2,571.00	-
Extras			
70706	70706	USD 23.00	-

WORKSHOP TABLE / 200 X 92 CM / 78.7 X 36.2"

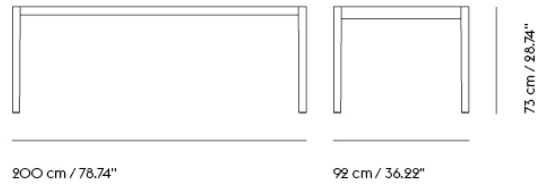

Shipper Colli 1
 Gross Weight (kg) 44
 Net Weight (kg) 39.55
 Warranty Period 10 years

Pattern No.	Color	Contract Price	Lead Time
Ready-To-Ship EU Warehouse			
MWRKDT7836-OAK	Oak Veneer/Oak	USD 3,516.00	-
MWRKDT7836-BLCK-BLCK	Black Linoleum/Black	USD 3,306.00	-
MWRKDT7836-WMGY-OAK	Warm Grey Linoleum/Oak	USD 3,306.00	-
Extras			
70706	70706	USD 23.00	-

**WORKSHOP COFFEE TABLE / 120 X 43 CM
/ 47.2" X 16.9"**

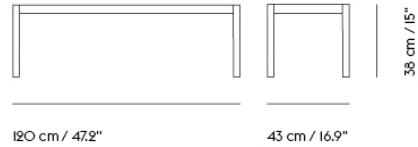

Shipper Colli 1
 Gross Weight (kg) 10.5
 Net Weight (kg) 8.46
 Warranty Period 5 years

Pattern No.	Color	Contract Price	Lead Time
Ready-To-Ship US Warehouse			
MWRKCT4717-BOAK	Black	USD 866.00	-
MWRKCT4717-OAK	Oak Veneer/Oak	USD 866.00	-
MWRKCT4717-BLCK	Black Linoleum/Black	USD 845.00	-
MWRKCT4717-WMGY	Warm Grey Linoleum/Oak	USD 845.00	-
Extras			
70706	70706	USD 23.00	-

WORKSHOP COFFEE TABLE / 86 X 86 CM / 33.9" X 33.9"

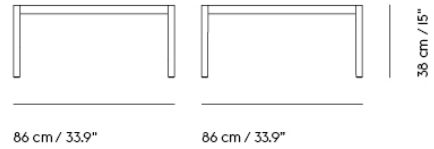

Shipper Colli 1
 Gross Weight (kg) 11.8
 Net Weight (kg) 9.22
 Warranty Period 10 years

Pattern No.	Color	Contract Price	Lead Time
Ready-To-Ship US Warehouse			
MWRKCT3434-BOAK	Black	USD 1,101.00	-
MWRKCT3434-OAK	Oak Veneer/Oak	USD 1,101.00	-
MWRKCT3434-BLCK	Black Linoleum/Black	USD 1,028.00	-
MWRKCT3434-WMGY	Warm Grey Linoleum/Oak	USD 1,028.00	-
Extras			
70706	70706	USD 23.00	-

WRAP LOUNGE CHAIR

“Designing the Wrap Lounge Chair, we had the image of a lounge chair with a soft blanket simply draped around its ample silhouette in mind, playing with models and prototypes to find a fluid way of incarnating this idea. We were driven by the idea of creating a really snug chair with an enveloping feel and generous proportions that don't feel chunky. A highly comfortable lounge chair with lots of personality. The striking and soft, upholstered shell sits in a simple and light steel structure, giving it a visual lightness and a compelling contrast. Wrap Lounge Chair is simple, sophisticated and not least, cleverly made.”



— Normal Studio

Designed by	Normal Studio
Environment	Indoor
Country of Production	Poland
Assembly Required	No
Description	Wrap is a soft lounge chair with a blanket-like textile wrapped around its shell, allowing a deep sense of comfort with a strong sense of character. While its design is guided by the search for ultimate comfort, its generous shape is supported by a light steel frame creating a contrasting image of airy lightness. The draped upholstery is a result of extensive research and development as well as craftsmanship and know-how. The Wrap Lounge Chair is simple, yet refined, combining a sense of ease with a strong design language.
Material	Interior shell made of pressed felt from 100% recycled post-consumer plastic with a steel reinforcement. Wrap Lounge Chair's shell is clad with multiple layers of foam and wadding and finished with textile upholstery. Upholstered in high-quality textiles from Kvadrat and Rohleder. Tube base in powder coated steel with plastic gliders.
Cleaning & Care	<p>Textile:</p> <p>For general care we recommend a gentle vacuum cleaning between the seat and armrest or backrest. In case of stains, we generally recommend removing non-greasy stains by carefully dabbing with a lint-free cloth or sponge wrung out in clean warm water. If necessary, clean by dabbing with soapy water made with a little dish soap. Finally, dab the surface with clean water. We highly recommend that you go to kvadrat.dk for further cleaning and maintenance instructions for your chosen textile, as the cleaning methods may vary from one textile to another.</p> <p>Base:</p> <p>Clean with a moist cloth. If necessary, use a little dish soap on the cloth.</p>
	<p>CUSTOMIZED UPHOLSTERY</p> <p>Textile upholstery: 3,9 m / 4.3 yds</p>
	<p>TESTS & CERTIFICATIONS</p> <p>EN 16139:2013 - L2 Extreme use. Furniture - Strength, durability and safety. Requirements for non-domestic seating.</p> <p>ANSI/BIFMA X5.4- 2020 American National Standard for Office Furnishings Lounge and Public Seating</p> <p>VOC CDPH 01350 & VOC BIFMA X7.1. Wrap Lounge Chair is tested to VOC CDPH 01350 and VOC BIFMA X7.1.</p>

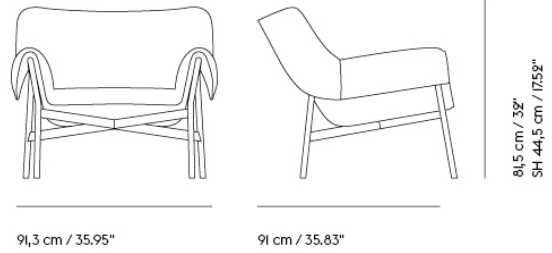

Shipper Colli	1
Gross Weight (kg)	45
Net Weight (kg)	40
Base color options	Grey or Black
Warranty Period	10 years

Pattern No.	Color	Contract Price	Lead Time
Ready-To-Ship US Warehouse			
MWRPLC-BLCK-M8404151	Sabi 151/Black	USD 3,096.00	-
MWRPLC-GREY-M10767240	Ecriture 240/Grey	USD 3,355.00	-

WRAP LOUNGE CHAIR



WRAP LOUNGE CHAIR

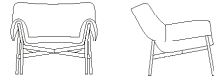

91 cm /
35.8"
SH 44.5 cm /
17.5"

81 cm / 31.9"

91.3 cm / 35.9"

Tube Base
Shipper Coll: 1
Gross Weight (kg): 45
Net Weight (kg): 40
Warranty Period: 10 years

All Upholstery Variants

All Variants

	Pattern No.	Upholstery Grades			
		A	COM	CIL	E
Wrap Lounge Chair	MWRPLC	2,676	3,096	3,201	3,355

HOW TO CONFIGURE

Specify:

- Step 1: Choose variant
- Step 2: Choose base color
- Step 3: Choose textile
- Step 4: Choose textile color

ORDER CODE EXAMPLE

Oslo Lounge Chair Tube Base in Colline 227

Variant	Wrap Lounge Chair
Base Color	Black
Textile	Colline
Textile Color	227
Final Pattern No:	MWRPLCBLCKM5416227

Base Finish Options

- BLCK - Black
- GREY - Grey

UPHOLSTERY OPTIONS

A	B	C	E
Ocean (M161)* Remix (M156)	Canvas (M153) Clara (M154) Colline (M5416) Fiord (M155) Hero (M164) Grain (M12659) Manner (M12665) Re-Wool (M4586) Sabi (M8404) Steelcut (M149) Steelcut Trio (M139)	Hallingdal (M146)	Acca (M12660) Beck (M6376) Divina (M150) Divina MD (M147) Divina Melange (M135) Ecriture (M10767) Hearth (M12664) Planum (M5904) Twill Weave (M142) Vidar (M158)

*Notes:
Ocean - Color 3, 21, 32, 50, 52, 80 & 601

LIGHTING

AMBIT LAMP SERIES

"What defines our attraction to shapes? With the Ambit Lamp Series, we wanted to explore form and proportions in a thorough and meticulous way. We discovered a unique dynamic between linear and rounded shapes that gives the lamp its unique outline, making the Ambit Lamp Series a timeless design that you'll never grow tired of while its handspun aluminum material and contrasting white inner makes for an elegant touch."

— TAF Studio



Designed by	TAF Studio
Environment	Indoor
Country of Production	China
Cord Length	Pendant Lamp and Rail Lamp: 400 cm / 157.5" Wall Lamp: 250 cm / 98.4"
Light Source Included	No
Ceiling Cap Included	Pendant Lamp and Rail Lamp: Yes Wall Lamp: No
Dimmable Function	Rail lamp: Yes (can be dimmed with industry standard phasecut dimmers, if dimmable bulb is used) Ambit Ø16,5: Yes (can be dimmed with industry standard phasecut dimmers) Ambit Ø25, Ø40 and Ø55: Yes (can be dimmed with industry standard phasecut dimmers, if dimmable bulb is used)
Socket Size	Ambit Ø25 and Rail Lamp: E12 Ambit Ø40 and Ø55: E26 Ambit Ø16,5 and Wall Lamp: GX53
Description	Embodying the values of Scandinavian design, the Ambit Lamp Series is as timeless as it is contemporary. Made of hand-spun aluminum that has been hand-painted, the Ambit Lamp Series features clean lines and a white interior that heighten contrasts of its outside shade while enhancing the light emitted in any room of a home, office or commercial space. Use the design on its own or symmetric formations and vibrant clusters.
Material	The lampshade, arm fixture, and wall mount piece are made from aluminum and wet painted. The cord is made from PVC. An extra wall bracket is included in the Ambit Wall Lamp. The lamp is dimmable when hardwired—no dimmer on cable.

Cleaning & Care

Rail Lamp:

The rail for the Ambit Rail Lamp is cut from tubes that are adjusted to fit each other on a lathe machine. Rail made from cast and extruded aluminum.

Wall Lamp:

Arm fixture and wall mount piece for the Ambit Wall Lamp are made from aluminum. An extra wall bracket is included in the Ambit Wall Lamp that allows for the wiring to be integrated into the wall.

Clean the lamp with a soft dry cloth. Always switch off the electricity before cleaning.

TESTS & CERTIFICATIONS

EU:

IEC 60598-1 and IEC 60598-2-1
 Low Voltage Directive (LVD) - 2014/35/EU
 ECO Design Directive - 245/2009/EC
 ROHS Directive - 2011/65/EU amended RoHS 3 Directive 2015/863
 REACH Directive - EC/1907/2006
 WEEE Directive - 2012/19/EU

UK:

BS EN 60598-1 and BS 4533-102.1, EN 60598-2-1
 Electrical Equipment (Safety) Regulations 2016
 Electromagnetic Compatibility Regulations 2016
 The Restriction of the Use of Certain Hazardous Substances in Electrical and Electronic Equipment Regulations 2012
 The Ecodesign for Energy-Related Products and Energy Information (Amendment) (EU Exit) Regulations 2019

The Eurasian Economic Union:

TP TC 004 and TP TC 020

USA/Canada:

UL STD. 1598 / CSA STD. C22.2 NO.250.0

Australia/New Zealand:

AS/NZS 60598.1 and AS/NZS 60598.2.1

*Does not apply to Ambit Pendant Ø16,5 and Ambit Wall Lamp

China:

GB 7000.201 and GB 7000.1

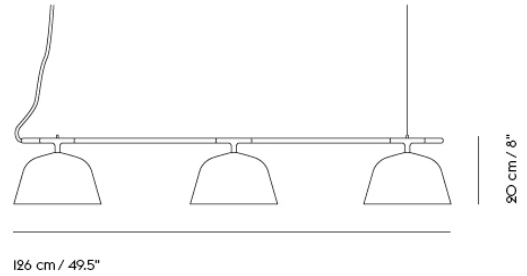

- Shipper Colli 1
- Gross Weight (kg) 4
- Net Weight (kg) 2
- Bulb included No
- Warranty Period 5 years

Pattern No.	Color	Contract Price	Lead Time
Ready-To-Ship US Warehouse			
MAMBRALP-BLCK	Black	USD 1,521.00	-
MAMBRALP-GREY	Grey	USD 1,521.00	-
MAMBRALP-TAUP	Taupe	USD 1,521.00	-
MAMBRALP-WHIT	White	USD 1,521.00	-
Extras			
12330	Ambit Rail/Linear Pendant - Spare kit	USD 23.00	-

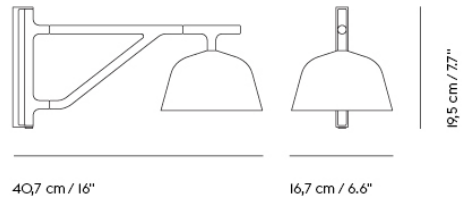

Shipper Colli	1
Gross Weight (kg)	1.734
Net Weight (kg)	1.04
Bulb included	Yes. Not applicable for North America,
Warranty Period	5 years

Pattern No.	Color	Contract Price	Lead Time
Ready-To-Ship US Warehouse			
MAMBWLLP-BLCK	Black	USD 639.00	-
MAMBWLLP-GREY	Grey	USD 639.00	-
MAMBWLLP-TAUP	Taupe	USD 639.00	-
MAMBWLLP-WHIT	White	USD 639.00	-

AMBIT PENDANT LAMP / Ø 16,5 CM / 6.5"

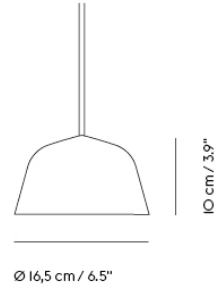

Shipper Colli 1
Gross Weight (kg) 1.0002
Net Weight (kg) 0.69
Bulb included EU version: yes, US version: no
Warranty Period 5 years

Pattern No.	Color	Contract Price	Lead Time
Ready-To-Ship US Warehouse			
MAMBPDLP06-BLCK	Black	USD 299.00	-
MAMBPDLP06-DGRN	Dusty Green	USD 299.00	-
MAMBPDLP06-GREY	Grey	USD 299.00	-
MAMBPDLP06-LTBU	Light Blue	USD 299.00	-
MAMBPDLP06-TAUP	Taupe	USD 299.00	-
MAMBPDLP06-WHIT	White	USD 299.00	-
Extras			
MLPCAPL	Ceiling Cap - White	USD 28.00	-

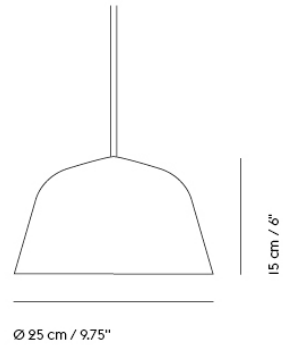

Shipper Colli 1
Gross Weight (kg) 1.1092
Net Weight (kg) 0.7
Bulb included No
Warranty Period 5 years

Pattern No.	Color	Contract Price	Lead Time
Ready-To-Ship US Warehouse			
MAMBPDLP09-BLCK	Black	USD 419.00	-
MAMBPDLP09-DGRN	Dusty Green	USD 419.00	-
MAMBPDLP09-GREY	Grey	USD 419.00	-
MAMBPDLP09-LTBU	Light Blue	USD 419.00	-
MAMBPDLP09-ROS	Rose	USD 419.00	-
MAMBPDLP09-TAUP	Taupe	USD 419.00	-
MAMBPDLP09-WHIT	White	USD 419.00	-
Extras			
MLPCAPL	Ceiling Cap - White	USD 28.00	-

AMBIT PENDANT LAMP / Ø 40 CM / 15.75"

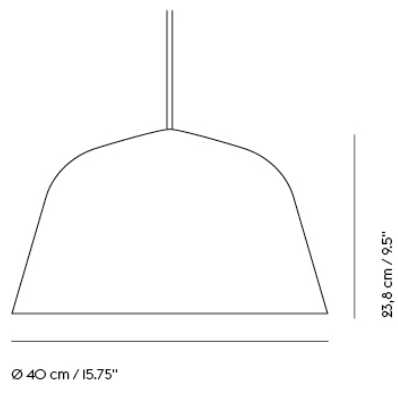

Shipper Colli 1
Gross Weight (kg) 2.9002
Net Weight (kg) 1.53
Bulb included No
Warranty Period 5 years

Pattern No.	Color	Contract Price	Lead Time
Ready-To-Ship US Warehouse			
MAMBPDLP15-BLCK	Black	USD 671.00	-
MAMBPDLP15-DGRN	Dusty Green	USD 671.00	-
MAMBPDLP15-GREY	Grey	USD 671.00	-
MAMBPDLP15-LTBU	Light Blue	USD 671.00	-
MAMBPDLP15-ROS	Rose	USD 671.00	-
MAMBPDLP15-TAUP	Taupe	USD 671.00	-
MAMBPDLP15-WHIT	White	USD 671.00	-
Extras			
MLPCAPL	Ceiling Cap - White	USD 28.00	-

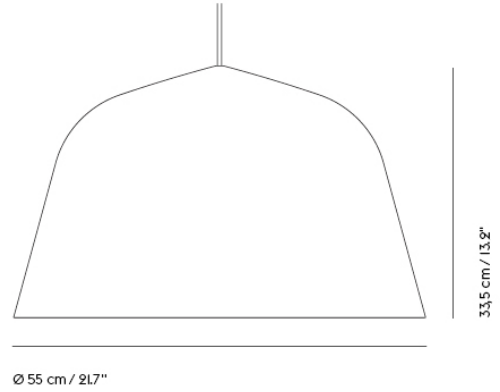

Shipper Colli	1
Gross Weight (kg)	5.585
Net Weight (kg)	2.7
Bulb included	No
Warranty Period	5 years

Pattern No.	Color	Contract Price	Lead Time
Ready-To-Ship US Warehouse			
MAMBPDLP22-BLCK	Black	USD 1,007.00	-
MAMBPDLP22-DGRN	Dusty Green	USD 1,007.00	-
MAMBPDLP22-GREY	Grey	USD 1,007.00	-
MAMBPDLP22-LTBU	Light Blue	USD 1,007.00	-
MAMBPDLP22-TAUP	Taupe	USD 1,007.00	-
MAMBPDLP22-WHIT	White	USD 1,007.00	-
Extras			
MLPCAPL	Ceiling Cap - White	USD 28.00	-

BEAM TABLE LAMP

"The idea for the Beam Table Lamp came while renovating my childhood home. I had made a shelf to use as divider between the hallway and living room and needed a lamp that could at once throw light out into the living room and down the hallway. The Beam Table Lamp mimics a single ray of light that travels through a round tube with its dimmer allowing the user to change the volume of light omitted from both ends of the cylinder shape. Tweak the design to your personal needs through its rotating base and sleek body of anodized aluminum, whether it be as direct lighting or for an ambient glow. With the Beam Table Lamp, you can alter the volume of light omitted, change its direction by the turn of its base and place it on any shelf, table or windowsill for a new perspective on modern lighting."



— Tom Chung

Designed by	Tom Chung
Environment	Indoor
Country of Production	China
Cord Length	250 cm / 98.4"
Light Source Included	Yes - integrated non-replaceable LED
Dimmable Function	Yes
Description	The Beam Table Lamp is a versatile table lamp with a modern expression and intuitive user-friendliness. With light shone from both ends of a cylinder shape, the user can choose between three different volumes of light and gradually alter the volume of light emitted in each end through the turn of a playful dial. The Beam Table Lamp can be altered for any position with its rotating base and sleek body of anodized aluminum, whether it be as direct lighting or for an ambient glow in any home, offices, hotel room and educational areas.
Material	Body in anodized aluminum for a matte feel and vibrant look. Cord in PVC. It has a built-in energy efficient LED bulb. The lifetime of the LED bulb is defined as the time it takes until the light output/lumen maintenance reaches 90% (L90) of the initial output. The integrated bulb has a lifespan/lumen maintenance (L90) of 35,000 hours.
Cleaning & Care	Clean with soft dry cloth only. Always switch off electricity supply before cleaning.

TESTS & CERTIFICATIONS

EU:

IEC 60598-1 and IEC 60598-2-4

Low Voltage Directive (LVD) - 2014/35/EU

ECO Design Directive - 245/2009/EC

ROHS Directive - 2011/65/EU amended RoHS 3 Directive
2015/863

REACH Directive - EC/1907/2006

WEEE Directive - 2012/19/EU

UK:

BS EN 60598-1 and EN 60598-2-4

Electrical Equipment (Safety) Regulations 2016

Electromagnetic Compatibility Regulations 2016

The Restriction of the Use of Certain Hazardous Substances in

Electrical and Electronic Equipment Regulations 2012

The Ecodesign for Energy-Related Products and Energy

Information (Amendment) (EU Exit) Regulations 2019

The Eurasian Economic Union:

TP TC 004 and TP TC 020

USA/Canada:

UL STD. 153 / CSA STD. C22.2 NO.250.4

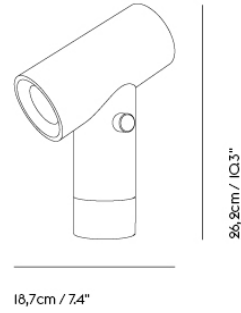

Shipper Colli	1
Gross Weight (kg)	1.72
Net Weight (kg)	1.234
Bulb included	Yes. Integrated non-replaceable LED
Warranty Period	5 years

Pattern No.	Color	Contract Price	Lead Time
Ready-To-Ship US Warehouse			
MBEATBLP-ALUM	Aluminum	USD 492.00	-
MBEATBLP-BLCK	Black	USD 492.00	-
MBEATBLP-GREN	Green	USD 492.00	-
MBEATBLP-UMBR	Umber	USD 492.00	-

CONTROL TABLE LAMP

"The Control Table Lamp is a unique and playful lamp with references to hi-fi and industrial machinery. The light and dimmer is controlled by a switch, referencing volume controls, and is an inviting and simple way of interacting with the user. While designing the lamp, we were inspired by the idea of displaying the different lamp components on a serving plate—almost as a still life. It was a pragmatic approach to making a lamp by the simplest means, a reduced design beyond reduction."

— TAF Studio



Designed by	TAF Studio
Environment	Indoor
Country of Production	China
Cord Length	250 cm / 98.5"
Light Source Included	Yes
Dimmable Function	Yes
Socket Size	E26
Description	The Control Table Lamp places the iconic E26 bulb in a modern context. With the user being able to alter the volume of light emitted according to their preferences through the playful turn of a dial, the Control Table Lamp combines industrial design with Scandinavian values.
Material	The lamp's base is casted in aluminum, polished and finally powder coated. Cord in PVC.
Cleaning & Care	Clean with soft dry cloth only. Always switch off the electricity supply before cleaning.

TESTS & CERTIFICATIONS

EU:

EN 60598-1 and EN 60598-2-4

Low Voltage Directive (LVD) - 2014/35/EU

ECO Design Directive - 245/2009/EC

ROHS Directive - 2011/65/EU amended RoHS 3 Directive 2015/863

REACH Directive - EC/1907/2006

WEEE Directive - 2012/19/EU

UK:

BS EN 60598-1 and EN 60598-2-4

Electrical Equipment (Safety) Regulations 2016

Electromagnetic Compatibility Regulations 2016

The Restriction of the Use of Certain Hazardous Substances in Electrical and Electronic Equipment Regulations 2012

The Ecodesign for Energy-Related Products and Energy Information (Amendment) (EU Exit) Regulations 2019

USA/Canada:

UL STD. 153 / CSA STD. C22.2 NO.250.4

Australia/New Zealand:

AS/NZS 60598.1 and AS/NZS 60598.2.4

*Does not apply to the following colors: Red

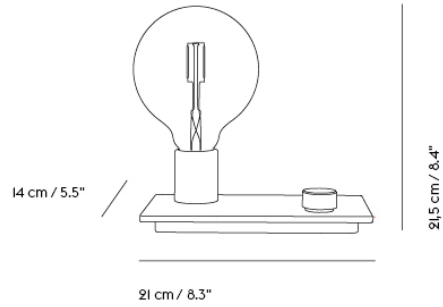

Shipper Colli	1
Gross Weight (kg)	1.4055
Net Weight (kg)	0.9125
Bulb included	Yes
Warranty Period	5 years

Pattern No.	Color	Contract Price	Lead Time
Ready-To-Ship US Warehouse			
MCONTBLP-BLCK	Black	USD 299.00	-
MCONTBLP-GREY	Grey	USD 299.00	-
MCONTBLP-RED	Red	USD 299.00	-
MCONTBLP-WHIT	White	USD 299.00	-

DEDICATE LAMP SERIES

“From a design perspective, the Dedicate Lamp is a harmonious exploration of an iconic form, ingeniously enhancing its functionality while maintaining a strong connection to its original concept. This transformation pays homage to its predecessor, seamlessly melding tradition with innovation.”

— Thomas Bentzen



Designed by	Thomas Bentzen
Environment	Indoor
Country of Production	China
Cord Length	250 cm / 98.4"
Light Source Included	Dimmable, integrated, and non-user replaceable LED light designed for Right to Repair which means that only an electrician can replace the light source.
Dimmable Function	Yes
Description	The Dedicate Lamp is a contemporary take on the classic architect lamp, where design meets functionality seamlessly. Meticulously engineered, the lamp offers integrated cooling ribs, quality lighting, dimming, and an auto-turn-off feature — while guaranteeing steadiness through its flexible arms. Available in various sizes, the Dedicate Lamp caters to diverse lighting needs and design preferences, providing a versatile lighting solution.
Material	The lamp head and hinges are in die-casted aluminum, and the lamp arms are in extruded aluminum. All powder coated. Diffuser in injection molded plastic. Table base in machined steel. Clamp and Wall Mount in die-casted aluminum and screw in stainless steel. Pin in machined steel screw and fixing nut. Integrated dimmable LED light source. Lumen: 750lm on 100% brightness. Lumen Maintenance (80%): >43,000h. Kelvin: 3000K. CRI >90. The lamp comes with a built-in 8-hour timer.
Cleaning & Care	Clean the Dedicate Lamp with a soft, dry cloth only. Always switch off the electricity supply before cleaning.

TESTS & CERTIFICATIONS

EU:

IEC 60598-1 and IEC 60598-2-4

Low Voltage Directive (LVD) - 2014/35/EU

ECO Design Directive - 245/2009/EC

Electromagnetic Compatibility (EMC) Directive - 2014/30/EU

ROHS Directive - 2011/65/EU amended RoHS 3 Directive 2015/863

REACH Directive - EC/1907/2006

WEEE Directive - 2012/19/EU

UK:

BS EN 60598-1 and EN 60598-2-4

Electrical Equipment (Safety) Regulations 2016

Electromagnetic Compatibility Regulations 2016

The Restriction of the Use of Certain Hazardous Substances in Electrical and Electronic Equipment Regulations 2012

The Ecodesign for Energy-Related Products and Energy Information (Amendment) (EU Exit) Regulations 2019

USA/Canada:

UL STD. 153 / CSA STD. C22.2 NO.250.4

Australia/New Zealand:

AS/NZS 60598.1 and AS/NZS 60598.2.4



- Shipper Colli 2
- Gross Weight (kg) 5.26
- Net Weight (kg) 4.41
- Bulb included Dimmable, integrated, and non-user replaceable LED
- Warranty period 5 years

Pattern No.	Color	Contract Price	Lead Time
Ready-To-Ship EU Warehouse			
MDDCLS1TBLP-BLCK	Black	USD 786.00	-
MDDCLS1TBLP-BRGR	Brown Green	USD 786.00	-

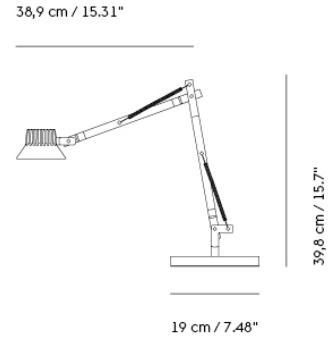

- Shipper Colli 2
- Gross Weight (kg) 5.59
- Net Weight (kg) 4.52
- Bulb included Dimmable, integrated, and non-user replaceable LED
- Warranty period 5 years

Pattern No.	Color	Contract Price	Lead Time
Ready-To-Ship EU Warehouse			
MDDCLS2TBLP/BLCK	Black	USD 835.00	-
MDDCLS2TBLP-BRGR	Brown Green	USD 835.00	-

DEDICATE TABLE LAMP / L2

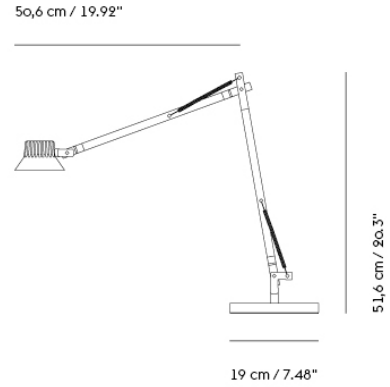

- Shipper Colli 2
- Gross Weight (kg) 5.74
- Net Weight (kg) 4.555
- Bulb included Dimmable, integrated, and non-user replaceable LED
- Warranty period 5 years

Pattern No.	Color	Contract Price	Lead Time
Ready-To-Ship EU Warehouse			
MDDCLL2TBLP-BLCK	Black	USD 835.00	-
MDDCLL2TBLP-BRGR	Brown Green	USD 835.00	-

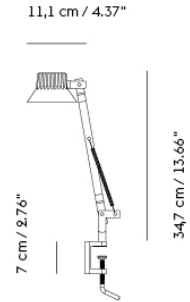

- Shipper Colli 2
- Gross Weight (kg) 0.885
- Net Weight (kg) 0.605
- Bulb included Dimmable, integrated, and non-user replaceable LED
- Warranty period 5 years

Pattern No.	Color	Contract Price	Lead Time
Ready-To-Ship EU Warehouse			
MDDCLS1WC-BLCK	Black	USD 629.00	-
MDDCLS1WC-BRGR	Brown Green	USD 629.00	-

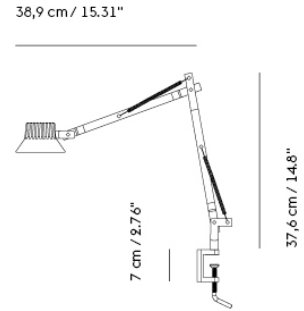
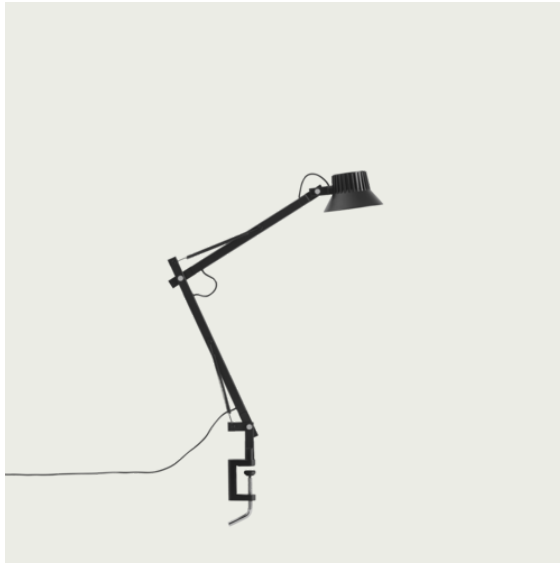

- Shipper Colli 2
- Gross Weight (kg) 1.215
- Net Weight (kg) 0.715
- Bulb included Dimmable, integrated, and non-user replaceable LED
- Warranty period 5 years

Pattern No.	Color	Contract Price	Lead Time
Ready-To-Ship EU Warehouse			
MDDCLS2WC-BLCK	Black	USD 677.00	-
MDDCLS2WC-BRGR	Brown Green	USD 677.00	-

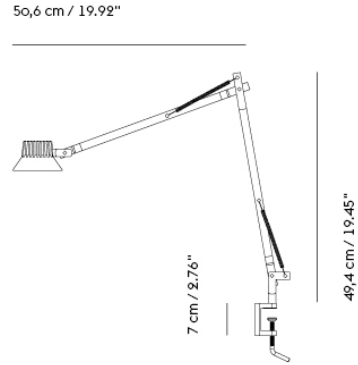

- Shipper Colli 2
- Gross Weight (kg) 1.365
- Net Weight (kg) 0.75
- Bulb included Dimmable, integrated, and non-user replaceable LED
- Warranty period 5 years

Pattern No.	Color	Contract Price	Lead Time
Ready-To-Ship EU Warehouse			
MDDCLL2WC-BLCK	Black	USD 677.00	-
MDDCLL2WC-BRGR	Brown Green	USD 677.00	-

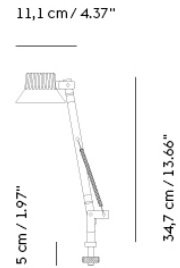

- Shipper Colli 2
- Gross Weight (kg) 0.76407
- Net Weight (kg) 0.58
- Bulb included Dimmable, integrated, and non-user replaceable LED
- Warranty period 5 years

Pattern No.	Color	Contract Price	Lead Time
Ready-To-Ship EU Warehouse			
MDDCLS1WP-BLCK	Black	USD 629.00	-
MDDCLS1WP-BRGR	Brown Green	USD 629.00	-

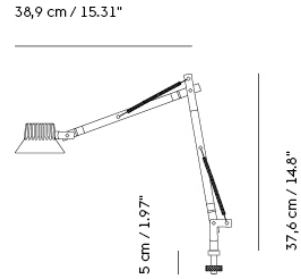

- Shipper Colli 2
- Gross Weight (kg) 1.235
- Net Weight (kg) 0.69
- Bulb included Dimmable, integrated, and non-user replaceable LED
- Warranty period 5 years

Pattern No.	Color	Contract Price	Lead Time
Ready-To-Ship EU Warehouse			
MDDCLS2WP-BLCK	Black	USD 677.00	-
MDDCLS2WP-BRGR	Brown Green	USD 677.00	-

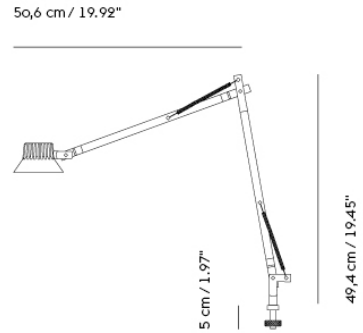

- Shipper Colli 2
- Gross Weight (kg) 1.385
- Net Weight (kg) 0.725
- Bulb included Dimmable, integrated, and non-user replaceable LED
- Warranty period 5 years

Pattern No.	Color	Contract Price	Lead Time
Ready-To-Ship EU Warehouse			
MDDCLL2WP-BLCK	Black	USD 677.00	-
MDDCLL2WP-BRGR	Brown Green	USD 677.00	-

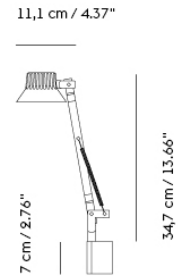

- Shipper Colli 2
- Gross Weight (kg) 0.84
- Net Weight (kg) 0.56
- Bulb included Dimmable, integrated, and non-user replaceable LED
- Warranty period 5 years

Pattern No.	Color	Contract Price	Lead Time
Ready-To-Ship EU Warehouse			
MDDCLS1WLLP-BLCK	Black	USD 629.00	-
MDDCLS1WLLP-BRGR	Brown Green	USD 629.00	-

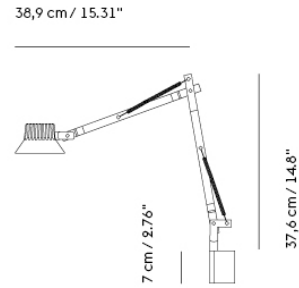

- Shipper Colli 2
- Gross Weight (kg) 1.17
- Net Weight (kg) 0.67
- Bulb included Dimmable, integrated, and non-user replaceable LED
- Warranty period 5 years

Pattern No.	Color	Contract Price	Lead Time
Ready-To-Ship EU Warehouse			
MDDCLS2WLLP-BLCK	Black	USD 677.00	-
MDDCLS2WLLP-BRGR	Brown Green	USD 677.00	-

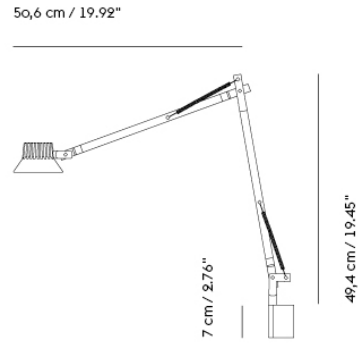

- Shipper Colli 2
- Gross Weight (kg) 1.32
- Net Weight (kg) 0.705
- Bulb included Dimmable, integrated, and non-user replaceable LED
- Warranty period 5 years

Pattern No.	Color	Contract Price	Lead Time
Ready-To-Ship EU Warehouse			
MDDCLL2WLLP-BLCK	Black	USD 677.00	-
MDDCLL2WLLP-BRGR	Brown Green	USD 677.00	-

E27 PENDANT LAMP

"The simplicity of the naked bulb is hard to compete with. It stands for something that feels romantic and contemporary at the same time. The E27 Pendant Lamp departs from the essence of a lamp—the socket—creating a simple yet strong object that celebrates the potential beauty in simplicity."

— Mattias Ståhlbom



Designed by	Mathias Ståhlbom
Environment	Indoor
Country of Production	China
Cord Length	400 cm / 157.5"
Light Source Included	Yes
Dimmable Function	Yes
Socket Size	E26
Description	The E27 Pendant Lamp joins together the ideas of industrial design and Scandinavian simplicity. With its naked LED bulb and sleek in a playful silicone rubber material, the design makes for a simple yet distinctive addition to any space. Use the E27 Pendant Lamp on its own or in clusters for any space of a home, workplace, restaurant, educational institution or retail space.
Material	The E27 Pendant Lamp is pressed in vulcanised silicone rubber under high temperature. The inside plastic socket and PVC cord is assembled by hand.
Cleaning & Care	Clean with soft dry cloth only. Always switch off the electricity supply before cleaning.

TESTS & CERTIFICATIONS

EU:

IEC 60598-1 and IEC 60598-2-1

Low Voltage Directive (LVD) - 2014/35/EU

ECO Design Directive - 245/2009/EC

ROHS Directive - 2011/65/EU amended RoHS 3 Directive 2015/863

REACH Directive - EC/1907/2006

WEEE Directive - 2012/19/EU

UK:

BS EN 60598-1 and BS 4533-102.1, EN 60598-2-1

Electrical Equipment (Safety) Regulations 2016

Electromagnetic Compatibility Regulations 2016

The Restriction of the Use of Certain Hazardous Substances in Electrical and Electronic Equipment Regulations 2012

The Ecodesign for Energy-Related Products and Energy Information (Amendment) (EU Exit) Regulations 2019

USA/Canada:

UL STD. 1598 / CSA STD. C22.2 NO.250.0

Australia/New Zealand:

AS/NZS 60598.1 and AS/NZS 60598.2.1

The Eurasian Economic Union:

TP TC 004 and TP TC 020

China:

GB 7000.201 and GB 7000.1

*Does not apply to the following colors: Beige-Green, Burgundy, Clay Brown

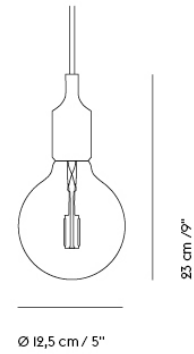

Shipper Colli	1
Gross Weight (kg)	0.7
Net Weight (kg)	0.3
Bulb included	Yes
Warranty Period	5 years

Pattern No.	Color	Contract Price	Lead Time
Ready-To-Ship US Warehouse			
ME27PDLP-DKGY	Dark Grey		-
ME27PDLP-BERO	Beige-Rose	USD 152.00	-
ME27PDLP-BLCK	Black	USD 152.00	-
ME27PDLP-CLBW	Clay Brown	USD 152.00	-
ME27PDLP-DKGN	Dark Green	USD 152.00	-
ME27PDLP-DPRD	Deep Red	USD 152.00	-
ME27PDLP-DLAC	Dusty Lilac	USD 152.00	-
ME27PDLP-LTBU	Light Blue	USD 152.00	-
ME27PDLP-LIGY	Light Grey	USD 152.00	-
ME27PDLP-LTOR	Light Orange	USD 152.00	-
ME27PDLP-MBLU	Midnight Blue	USD 152.00	-
ME27PDLP-MSTD	Mustard	USD 152.00	-
ME27PDLP-OLIV	Olive	USD 152.00	-
ME27PDLP-ORNG	Orange	USD 152.00	-
ME27PDLP-PABU	Pale Blue	USD 152.00	-
ME27PDLP-RED	Red	USD 152.00	-
ME27PDLP-ROSE	Rose	USD 152.00	-
ME27PDLP-TERR	Terracotta ***	USD 152.00	-
ME27PDLP-WHIT	White	USD 152.00	-
ME27PDLP-YELW	Yellow	USD 152.00	-

Pattern No.	Color	Contract Price	Lead Time
Extras			
MLPCRDE27P-BLCK	Unfold / E27 Cord - Black (per linear meter)	USD 4.00	-
MLPCRDE27P-OLIV	Unfold / E27 Cord - Olive (per linear meter)	USD 4.00	-
MLPCRDE27P-BEGN	E27 Cord - Beige-Green (per linear meter)	USD 5.00	-
MLPCRDE27P-BERO	E27 Cord - Beige-Rose (per linear meter)	USD 5.00	-
MLPCRDE27P-BLCK	E27 Cord - Black (per linear meter)	USD 5.00	-
MLPCRDE27P-BLUE	E27 Cord - Blue (per linear meter)	USD 5.00	-
MLPCRDE27P-BURG	E27 Cord - Burgundy (per linear meter)	USD 5.00	-
MLPCRDE27P-CLBW	E27 Cord - Clay Brown (per linear meter)	USD 5.00	-
MLPCRDE27P-LIGN	E27 Cord - Light Green (per linear meter)	USD 5.00	-
MLPCRDE27P-MSTD	E27 Cord - Mustard (per linear meter)	USD 5.00	-
MLPCRDE27P-PABU	E27 Cord - Pale Blue (per linear meter)	USD 5.00	-
MLPCRDE27P-RED	E27 Cord - Red (per linear meter)	USD 5.00	-
MLPCRDE27P-TERR	E27 Cord - Terracotta (per linear meter)	USD 5.00	-
MLPCRDE27P-YELW	E27 Cord - Yellow (per linear meter)	USD 5.00	-
MLPCRDUNFP-ORNG	Unfold / E27 Cord - Orange (per linear meter)	USD 5.00	-
MLPCAPL	Ceiling Cap - White	USD 28.00	-
MBULBLED	Dimmable Bulb for E27 Pendant Lamp	USD 42.00	-
ME27CPY	Multiple Canopy for E27 - White	USD 45.00	-

FLUID PENDANT LAMP

"We wanted to give the lamp a form with a certain softness, towards a more natural language and further removed from pure geometry. Fascinated by the way that surface tension governs the curvature of a resting water droplet, we have tried to capture its essence. The subtle irregularity of the Fluid Pendant Lamp means that their silhouette gently changes depending upon the viewing angle. It also brings a greater light intensity to the lamp's underside—just where you need it."

— Claesson Kovisto Rune



Designed by	Claesson Kovisto Rune
Environment	Indoor
Country of Production	China
Cord Length	350 cm / 137.75"
Light Source Included	Ø42: No / Ø23: Yes
Dimmable Function	Ø42: Yes / Ø23: No
Socket Size	Ø42: E26 / Ø23: G9
Ceiling Cap Included	Yes
Description	Inspired by a resting drop of water, the Fluid Pendant Lamp shows how soft light can diffuse across a space for a cosy atmosphere. The frosted matte surface creates a glowing ambience that fits into any home or casual business setting. Present the design individually or in a group for an intimate atmosphere.
Material	White silk matte opal glass, lid in Nylon 66 with fibre glass.
Cleaning & Care	Clean with soft dry cloth only. Always switch off the electricity supply before cleaning.

TESTS & CERTIFICATIONS

EU:

IEC 60598-1 and IEC 60598-2-1

Low Voltage Directive (LVD) - 2014/35/EU

ECO Design Directive - 245/2009/EC

ROHS Directive - 2011/65/EU amended RoHS 3 Directive 2015/863

REACH Directive - EC/1907/2006

WEEE Directive - 2012/19/EU

UK:

BS EN 60598-1 and BS 4533-102.1, EN 60598-2-1

Electrical Equipment (Safety) Regulations 2016

Electromagnetic Compatibility Regulations 2016

The Restriction of the Use of Certain Hazardous Substances in Electrical and Electronic Equipment Regulations 2012

The Ecodesign for Energy-Related Products and Energy Information (Amendment) (EU Exit) Regulations 2019

The Eurasian Economic Union:

TP TC 004 and TP TC 020

USA/Canada:

UL STD. 1598 / CSA STD. C22.2 NO.250.0

Australia/New Zealand:

AS/NZS 60598.1 and AS/NZS 60598.2.1

China:

GB 7000.201 and GB 7000.1

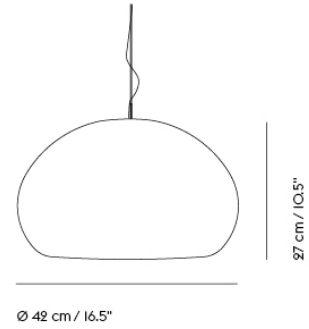

Shipper Colli 1
Gross Weight (kg) 4.95
Net Weight (kg) 3.1
Bulb included No
Warranty Period 5 years

Pattern No.	Color	Contract Price	Lead Time
Ready-To-Ship US Warehouse			
MFLUPDLPLG	Opal White - Large	USD 667.00	-
Extras			
MBULBP	Dimmable Bulb for Fluid Small and Grain Pendant Lamp	USD 37.00	-
MLPCAPW	Ceiling Cap for wire suspension lamps - White	USD 58.00	-

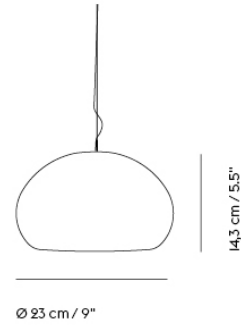

Shipper Colli 1
Gross Weight (kg) 1.55
Net Weight (kg) 0.85
Bulb included Yes
Warranty Period 5 years

Pattern No.	Color	Contract Price	Lead Time
Ready-To-Ship US Warehouse			
MFLUPDLPSM	Opal White - Small	USD 362.00	-
Extras			
MBULBP	Dimmable Bulb for Fluid Small and Grain Pendant Lamp	USD 37.00	-
MLPCAPW	Ceiling Cap for wire suspension lamps - White	USD 58.00	-

GRAIN PENDANT LAMP

"The Grain Pendant Lamp is a versatile light with a warm and welcoming appearance, complemented by a soft form that generously spreads the light underneath. The design is made from a unique mix of bamboo grain and plastic, adding a new perspective to the archetypal pendant lamp through its visual expression and matte touch."

— Jens Fager



Designed by	Jens Fager
Environment	Indoor
Country of Production	China
Cord Length	400 cm / 157.5"
Light Source Included	Yes
Dimmable Function	Yes
Socket Size	G9
Ceiling Cap Included	Yes
Description	The traditional pendant silhouette receives a poetic reinterpretation with the Grain Lamp. Simple and elegant, the lamp has small grains of fiber in its surface, creating a subtle texture and change in the diffusion of light. The pendant includes an LED lightbulb that lasts for up to 10,000 hours and provides a warm, natural glow.
Material	Lamp Shade in mixture of bamboo fibers and polypropylene. PVC cord. The lamp's shade is made under high pressure casting. Shade and electrical components are hereafter assembled by hand.
Cleaning & Care	Clean with a moist cloth. Always switch off the electricity supply before cleaning.

TESTS & CERTIFICATIONS

EU:

IEC 60598-1 and IEC 60598-2-1

Low Voltage Directive (LVD) - 2014/35/EU

ECO Design Directive - 245/2009/EC

ROHS Directive - 2011/65/EU amended RoHS 3 Directive 2015/863

REACH Directive - EC/1907/2006

WEEE Directive - 2012/19/EU

UK:

BS EN 60598-1 and BS 4533-102.1, EN 60598-2-1

Electrical Equipment (Safety) Regulations 2016

Electromagnetic Compatibility Regulations 2016

The Restriction of the Use of Certain Hazardous Substances in Electrical and Electronic Equipment Regulations 2012

The Ecodesign for Energy-Related Products and Energy Information (Amendment) (EU Exit) Regulations 2019

USA/Canada:

UL STD. 1598 / CSA STD. C22.2 NO.250.0

Australia/New Zealand:

AS/NZS 60598.1 and AS/NZS 60598.2.1

China:

GB 7000.201 and GB 7000.1

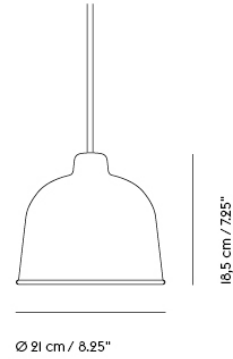

Shipper Colli	1
Gross Weight (kg)	1.17
Net Weight (kg)	0.76
Bulb included	Yes
Warranty Period	5 years

Pattern No.	Color	Contract Price	Lead Time
Ready-To-Ship US Warehouse			
MGRAPDLP-BLCK	Black	USD 303.00	-
MGRAPDLP-BUGY	Blue Grey	USD 303.00	-
MGRAPDLP-DKGN	Dark Green	USD 303.00	-
MGRAPDLP-DGRN	Dusty Green	USD 303.00	-
MGRAPDLP-GREY	Grey	USD 303.00	-
MGRAPDLP-NATU	Nature	USD 303.00	-
MGRAPDLP-WHIT	White	USD 303.00	-
Extras			
MLPCRDGRNP-BUGY	Grain Cord - Blue-Grey (per linear meter)	USD 5.00	-
MLPCRDGRNP-DKGN	Grain Cord - Dark Green (per linear meter)	USD 5.00	-
MLPCRDGRNP-DGRN	Grain Cord - Dusty Green (per linear meter)	USD 5.00	-
MLPCRDGRNP-GREY	Grain Cord - Grey (per linear meter)	USD 5.00	-
MLPCRDGRNP-NATU	Grain Cord - Nature (per linear meter)	USD 5.00	-
MLPCRDGRNP-BLCK	Rime Ø12+Ø25 / Grain Cord - Black (per linear meter)	USD 5.00	-
MLPCRDGRNP-WHIT	Rime Ø12+Ø25 / Grain Cord - White (per linear meter)	USD 5.00	-
MLPCAPL	Ceiling Cap - White	USD 28.00	-
MBULBP	Dimmable Bulb for Fluid Small and Grain Pendant Lamp	USD 37.00	-

LEAF LAMP SERIES

"Combining a light and elegant design with an energy-efficient LED technology, the Leaf Lamp Series has a clean and refined expression. The asymmetric geometry of the design gives it an organic and friendly appearance, inspired by the leaves on a tree. Turn the Leaf Lamp according to your needs and discover how the lamp will subtly transform its shape, adding a graphic and gentle light silhouette to any space."

— Broberg & Ridderstråle



Designed by	Broberg & Ridderstråle
Environment	Indoor
Country of Production	China
Cord Length	180 cm / 71"
Light Source Included	Yes - integrated non-replaceable LED
Dimmable Function	Yes
Description	With its elegantly simple lines, the Leaf Lamp Series brings ambient as well as direct lighting to any space, paired with its organic shape that is inspired by the leaves of a tree. The design features a dimmable LED light alongside a turnable head, allowing for its user to position the light as desired for one's individual space and atmosphere.
Material	Aluminum, brass, colored PVC cord. Leaf is a result of a process combining turned and casted aluminum and steel, with a strong powder coating as paint. It has a build-in energy-efficient LED bulb with a Lumen Maintenance (Lifetime) of L90 BIO 35.000 hours.
Cleaning & Care	Wipe off dust with dry cloth. If necessary use moist cloth, then dry off. Do not use abrasive cleaning agents. Always switch off the electricity supply before cleaning.

TESTS & CERTIFICATIONS

EU:

IEC 60598-1 and IEC 60598-2-4

Low Voltage Directive (LVD) - 2014/35/EU

ECO Design Directive - 245/2009/EC

ROHS Directive - 2011/65/EU amended RoHS 3 Directive 2015/863

REACH Directive - EC/1907/2006

WEEE Directive - 2012/19/EU

UK:

BS EN 60598-1 and EN 60598-2-4

Electrical Equipment (Safety) Regulations 2016

Electromagnetic Compatibility Regulations 2016

The Restriction of the Use of Certain Hazardous Substances in Electrical and Electronic Equipment Regulations 2012

The Ecodesign for Energy-Related Products and Energy Information (Amendment) (EU Exit) Regulations 2019

USA/Canada:

UL STD. 153 / CSA STD. C22.2 NO.250.4

Australia/New Zealand:

AS/NZS 60598.1 and AS/NZS 60598.2.4

*Does not apply to the following colors: Copper Brown, Dark Green

LEAF TABLE LAMP

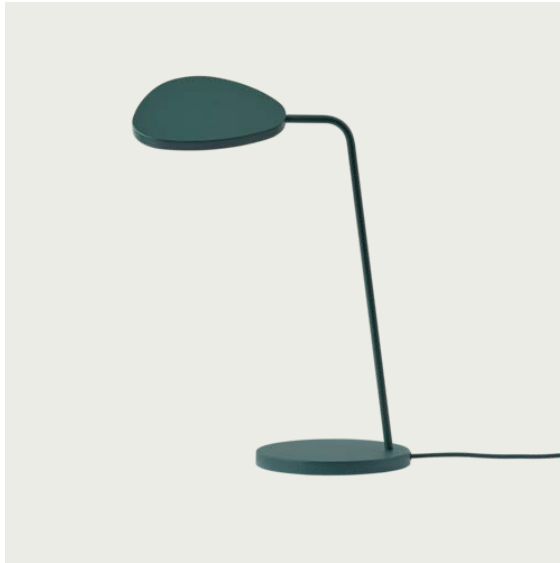

15,5 x 18,5 cm / 6" x 7.25"

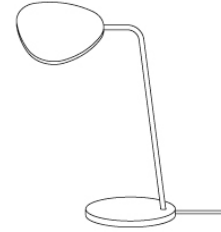

41,5 cm / 16.35"

18 cm / 7"

Shipper Colli	1
Gross Weight (kg)	2.5
Net Weight (kg)	1.75
Bulb included	Yes. Integrated non-replaceable LED
Warranty Period	5 years

Pattern No.	Color	Contract Price	Lead Time
Ready-To-Ship US Warehouse			
MLEATBLP-BLCK	Black	USD 492.00	-
MLEATBLP-CPBN	Copper Brown	USD 492.00	-
MLEATBLP-DKGN	Dark Green	USD 492.00	-
MLEATBLP-GREY	Grey	USD 492.00	-
MLEATBLP-WHIT	White	USD 492.00	-

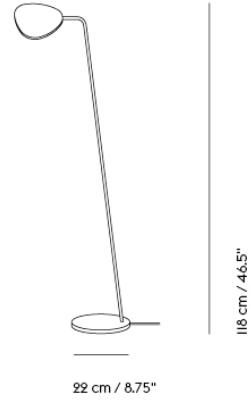
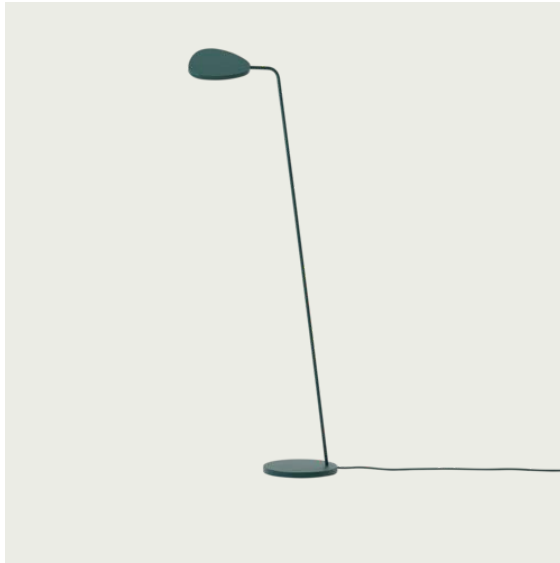

Shipper Colli	1
Gross Weight (kg)	5.2
Net Weight (kg)	2.8
Bulb included	Yes. Integrated non-replaceable LED
Warranty Period	5 years

Pattern No.	Color	Contract Price	Lead Time
Ready-To-Ship US Warehouse			
MLEAFLLP-BLCK	Black	USD 671.00	-
MLEAFLLP-CPBN	Copper Brown	USD 671.00	-
MLEAFLLP-DKGN	Dark Green	USD 671.00	-
MLEAFLLP-GREY	Grey	USD 671.00	-
MLEAFLLP-WHIT	White	USD 671.00	-

LINEAR LAMP SERIES

“The Linear Lamp Series is designed from the idea of creating smaller atmospheres through modern light, bringing a sense of intimacy to larger spaces. With their elegant expression, subtle details and inherent functionality, the designs create space for both being and working on your own as well as making for a friendly environment when in the company of others. Use the Linear Lamp Series in any space in need of modern, functional lighting.”

— Thomas Bentzen



Designed by	Thomas Bentzen
Environment	Indoor
Country of Production	China
Cord Length	Table Lamp: 250 cm / 98.4". Mounted Lamp: 150 cm / 59.1". Pendant Lamp: 400 cm / 157.5"
Light Source Included	Yes - integrated, dimmable, non-replaceable LED module.
Dimmable Function	Yes: Table Lamp and Mounted Lamp / No: Pendant Lamp
Description	Designed from the idea of creating smaller spaces within larger settings, the Linear Lamp Series by Thomas Bentzen is created with subtlety at its heart—simple lines, inviting functionalities and dimmable light that can be adjusted to any setting. The Linear Table & Mounted Lamps hint toward the archetypal library lamp with a modern expression, paired with the extensive functionality of dimmability. Available in two sizes, the Linear Mounted Lamp brings a friendly canopy of light to any space.
Material	Linear Pendant Lamp: Powder coated lamp head in pressure die-casted and extruded aluminum. Linear Table Lamp & Linear Mounted Lamp: Powder coated lamp head in extruded aluminum. Diffuser in polycarbonate. PVC cord.
Cleaning & Care	Clean with a moist cloth. If necessary, use a little dish soap on the cloth.

TESTS & CERTIFICATIONS

EU:

Linear Table / Linear Mounted:

IEC 60598-1 and IEC 60598-2-4

Linear Pendant:

IEC 60598-1 and IEC 60598-2-1

Low Voltage Directive (LVD) - 2014/35/EU

ECO Design Directive - 245/2009/EC

ROHS Directive - 2011/65/EU amended RoHS 3 Directive 2015/863

REACH Directive - EC/1907/2006

WEEE Directive - 2012/19/EU

UK:

Linear Table / Linear Mounted:

BS EN 60598-1 and EN 60598-2-4

Linear Pendant:

BS 4533-102.1, EN 60598-2-1

Electrical Equipment (Safety) Regulations 2016

Electromagnetic Compatibility Regulations 2016

The Restriction of the Use of Certain Hazardous Substances in Electrical and Electronic Equipment Regulations 2012

The Ecodesign for Energy-Related Products and Energy Information (Amendment) (EU Exit) Regulations 2019

US/Canada:

Linear Table/Linear Mounted:

UL 153 / CSA C22.2 No. 250.4

Linear Pendant:

UL STD. 1598 / CSA STD. C22.2 No. 250.0

Australia/New Zealand:

Linear Table / Linear Mounted:

AS/NZS 60598.1

AS/NZS 60598.2.4

Linear Pendant:

AS/NZS 60598.2.1



- Shipper Colli 1
- Gross Weight (kg) 1.832
- Net Weight (kg) 1.3
- Bulb included Yes. Integrated, dimmable, non-replaceable LED module.
- Warranty Period 5 years

Pattern No.	Color	Contract Price	Lead Time
Ready-To-Ship US Warehouse			
MLINLTBLP-BLCK	Black	USD 492.00	-
MLINLTBLP-GREY	Grey	USD 492.00	-

LINEAR MOUNTED LAMP / 209,2 CM / 82.4"

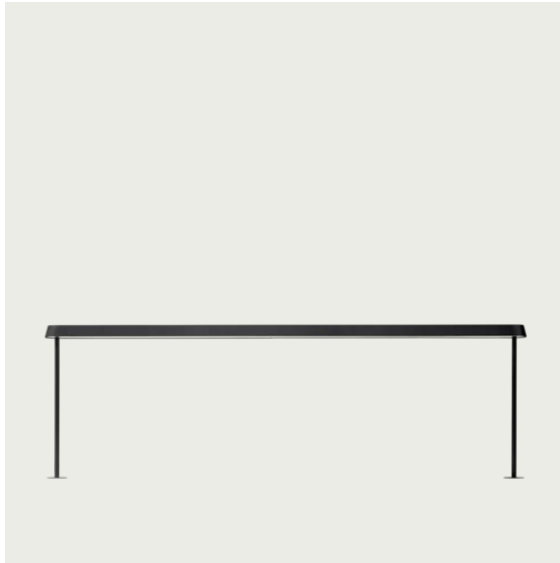

- Shipper Colli 1
- Gross Weight (kg) 7.8
- Net Weight (kg) 4.8
- Please note Only usable with Linear System Power Kit. The connector pins in this product contains lead, CAS no. 7439-92-1.
- Bulb included Yes. Integrated LED.
- Warranty Period 5 years

Pattern No.	Color	Contract Price	Lead Time
Ready-To-Ship US Warehouse			
MLINSYML82-BLCK	Black	USD 2,046.00	-
MLINSYML82-GREY	Grey	USD 2,046.00	-

LINEAR MOUNTED LAMP / 23,2 CM / 9.1"

499

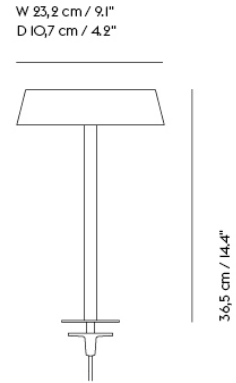

Shipper Colli	1
Gross Weight (kg)	1.5
Net Weight (kg)	1
Please note	1. Only usable with Linear System Power Kit. The connector pins in this product contains lead, CAS no. 7439-92-
Bulb included	Yes. Integrated LED.
Warranty Period	5 years

Pattern No.	Color	Contract Price	Lead Time
Ready-To-Ship US Warehouse			
MLINSYML9-BLCK	Black	USD 614.00	-
MLINSYML9-GREY	Grey	USD 614.00	-

LINEAR PENDANT LAMP / 169,2 CM / 66.6"

500



W 169,2 cm / 66.6"
D 10,7 cm / 4.2"

5,4 cm / 2.1"

Shipper Colli	1
Gross Weight (kg)	4.9
Net Weight (kg)	3.3
Bulb included	Yes. Integrated LED.
Warranty Period	5 years

Pattern No.	Color	Contract Price	Lead Time
Ready-To-Ship US Warehouse			
MLINLPDLP66-BLCK	Black	USD 1,465.00	-
MLINLPDLP66-GREY	Grey	USD 1,465.00	-
Extras			
12330	Ambit Rail/Linear Pendant - Spare kit	USD 23.00	-

LINEAR PENDANT LAMP / 87,2 CM / 34.3"

501



W 87,2 cm / 34,3"
D 10,7 cm / 4,2"

Shipper Colli	1
Gross Weight (kg)	3.2
Net Weight (kg)	2.2
Bulb included	Yes. Integrated LED.
Warranty Period	5 years

Pattern No.	Color	Contract Price	Lead Time
Ready-To-Ship US Warehouse			
MLINLPDLP34-BLCK	Black	USD 1,101.00	-
MLINLPDLP34-GREY	Grey	USD 1,101.00	-
Extras			
12330	Ambit Rail/Linear Pendant - Spare kit	USD 23.00	-

POST LAMP SERIES

"The Post Lamp Series came from the idea of exploring the flexibility of the magnetic joint, giving the user the freedom to position and dim the lamp's light units according to individual needs. Designed with a sculptural expression, simple lines and a refined finish, the Post Lamp Series represents a new perspective through its graphic character and forward-thinking functionality."

— Earnest Studio



Designed by	Earnest Studio
Environment	Indoor
Country of Production	China
Cord Length	Lighting units: 250 cm / 98.4" / Power Hub: 200 cm / 78.7"
Light Source Included	Yes - integrated, dimmable, replaceable LED module.
Dimmable Function	Yes
Description	The Post Lamp Series is an innovative lighting design with an archetypal appearance, graphic character and forward-thinking functionalities. Exploring the utmost flexibility of a magnetic joint, the user can position, dim and turn the lamp according to individual needs. Arrange the cord of the design in linear or playful formations on the wall, using its cable drop. Additional lighting units can be purchased as spare part and plugged into power hub.
Material	Lighting unit in powder coated magnesium with silicone cord and opal diffuser. Cable drops in ABS with magnet. Post Table Lamp power supply with ABS connector and PVC cord. Post Floor Lamp and Wall Lamp power hub in powder coated plastic with PVC cord. Post Wall Lamp Wall mounting bracket in powder coated steel and wall cable drops in powder coated steel with magnet and repositionable adhesive tape. Post Floor Lamp and Table Lamp Base in powder coated steel.
Cleaning & Care	Clean with soft dry cloth only. Always switch off the electricity supply before cleaning.

TESTS & CERTIFICATIONS

EU:

IEC 60598-1 and IEC 60598-2-4

Low Voltage Directive (LVD) - 2014/35/EU

ECO Design Directive - 245/2009/EC

ROHS Directive - 2011/65/EU amended RoHS 3 Directive 2015/863

REACH Directive - EC/1907/2006

WEEE Directive - 2012/19/EU

UK:

BS EN 60598-1 and EN 60598-2-4

Electrical Equipment (Safety) Regulations 2016

Electromagnetic Compatibility Regulations 2016

The Restriction of the Use of Certain Hazardous Substances in Electrical and Electronic Equipment Regulations 2012

The Ecodesign for Energy-Related Products and Energy Information (Amendment) (EU Exit) Regulations 2019

USA/Canada:

UL STD. 153 / CSA STD. C22.2 NO.250.4

Australia/New Zealand:

AS/NZS 60598.1 / 60598.2.4

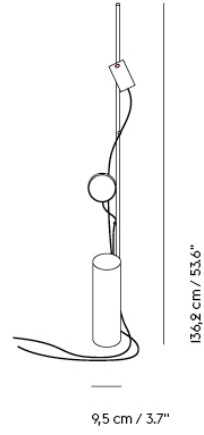
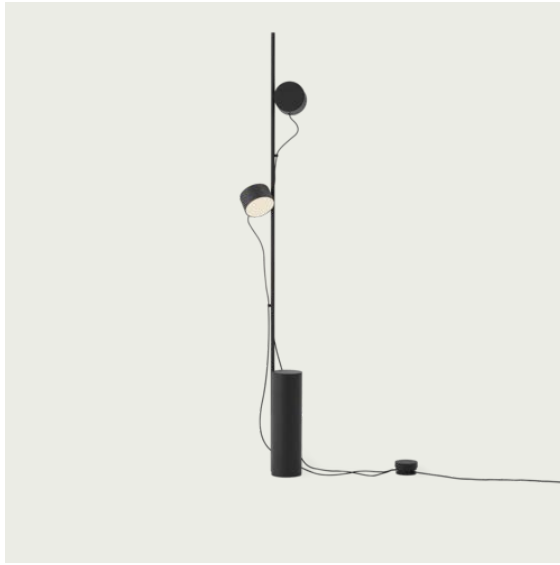

- Shipper Colli 1
- Gross Weight (kg) 12.5
- Net Weight (kg) 10.2
- Bulb included Yes. Integrated non-replaceable LED
- Warranty Period 5 years

Pattern No.	Color	Contract Price	Lead Time
Ready-To-Ship US Warehouse			
MPOSFLP	Black	USD 1,206.00	-
Extras			
MPLCD	Extra Cable Drops - Black	USD 49.00	-

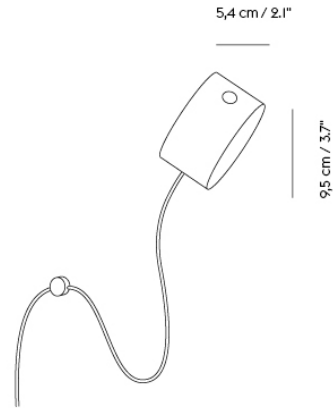

- Shipper Colli |
- Gross Weight (kg) | 1.05
- Net Weight (kg) | 0.55
- Bulb included | Yes. Integrated non-replaceable LED
- Warranty Period | 5 years

Pattern No.	Color	Contract Price	Lead Time
Ready-To-Ship US Warehouse			
MPOSWLLP	Black	USD 492.00	-
Extras			
MPOSWMNT	Extra Wall Mount - Black	USD 41.00	-

PULL FLOOR LAMP

"The Pull Floor Lamp brings a new perspective to the traditional floor light through its playful personality and warm, Scandinavian materials. With its partially hidden cord connecting the elements of the design and allowing for adjusting of its shade, the Pull Lamp can be tweaked to the mood and needs of any space, enhancing the expression of the design as well as the ambience of the room."

— Whatswhat



Designed by	Whatswhat
Environment	Indoor
Country of Production	Denmark
Cord Length	200 cm / 78,7"
Light Source Included	No
Dimmable Function	Yes - dimmable switch included
Socket Size	E26
Description	Taking cues from the materiality of Scandinavian design with a playful approach, the Pull Floor Lamp's combines the warmth of oak with an adjustable shade, allowing for its direction of light to be altered according to your given spatial needs.
Material	Natural oak wood with white covered plast composite. Wood parts are handmade by manual lathe and wood carving machines. Shade is hand crafted and handled carefully through every step. Cord in PVC.
Cleaning & Care	Wipe off dust with dry cloth. If necessary use moist cloth, then dry off. Always clean along the grains of the wood. Always switch off the electricity supply before cleaning.

TESTS & CERTIFICATIONS

EU:

IEC 60598-1 and IEC 60598-2-4
 Low Voltage Directive (LVD) - 2014/35/EU
 ECO Design Directive - 245/2009/EC
 ROHS Directive - 2011/65/EU amended RoHS 3 Directive 2015/863
 REACH Directive - EC/1907/2006
 WEEE Directive - 2012/19/EU

UK:

BS EN 60598-1 and EN 60598-2-4
 Electrical Equipment (Safety) Regulations 2016
 Electromagnetic Compatibility Regulations 2016
 The Restriction of the Use of Certain Hazardous Substances in Electrical and Electronic Equipment Regulations 2012
 The Ecodesign for Energy-Related Products and Energy Information (Amendment) (EU Exit) Regulations 2019

USA/Canada:

UL STD. 153 / CSA STD. C22.2 NO.250.4

PULL FLOOR LAMP

507

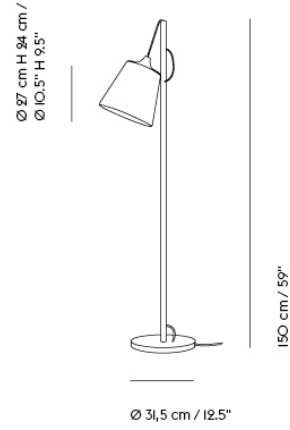

Shipper Colli	1
Gross Weight (kg)	6.75
Net Weight (kg)	3.75
Bulb included	No
Warranty Period	5 years

Pattern No.	Color	Contract Price	Lead Time
Ready-To-Ship US Warehouse			
MPULFLLP-GREYW	Grey/White	USD 786.00	-
MPULFLLP-OAKW	Oak/White	USD 786.00	-

RIME PENDANT LAMP

"The Rime Lamp Series merges timeless appeal with contemporary design, featuring a translucent shade that offers a sophisticated, graphic statement. We aimed to craft minimalist lamps that embody elegance through the glass form, achieving a delicate presence. Inspired by the natural curves of acorns, we shaped the Pendant and Wall lamps to reflect gentle lines while drawing from the muted beauty of frost and ice for the lamp's glass, ensuring a softly diffused light."

— TAF Studio



Designed by	TAF Studio / 2020
Environment	Indoor
Country of Production	Poland
Cord Length	400 cm / 157.5"
Light Source Included	Wall Lamp: Yes Ø25, Ø37 and Ø45: No
Dimmable Function	Yes - If dimmable bulb is used
Socket Size	Wall Lamp: G9 / Ø25: E12 / Ø37 and Ø45: E26
Ceiling Cap Included	Yes - for pendant lamp Ø25: Ø9 / 3.5" H 5,6 cm / 2.2 Ø37 and Ø45: Ø11 / 4.3" H 3,5 / 1.4"
Description	<p>The Rime Lamp Series brings an elegant perspective to the glass light through its semitransparent glass that has been sandblasted for a refined expression. The design features a characteristic form, inspired by the shape of acorns, complemented by its powder coated elements for a subtle touch.</p> <p>*Please note that the availability of sizes and/or colors of this product are subject to regional stock levels.</p>
Material	<p>Pendant: Mouth-blown glass shade. Aluminum, powder coated top-piece and pendant tube. PVC cord.</p> <p>Wall lamp: Mouth-blown glass shade. Wall bracket in aluminum, pressure die-casted and powder coated.</p> <p>Wall bracket in steel and chrome plated.</p>
Cleaning & Care	Clean with a moist cloth. If necessary, use a little dish soap on the cloth. Always switch off the electricity supply before cleaning.

TESTS & CERTIFICATIONS

EU:

IEC 60598-1 and IEC 60598-2-1

Low Voltage Directive (LVD) - 2014/35/EU

ECO Design Directive - 245/2009/EC

ROHS Directive - 2011/65/EU amended RoHS 3 Directive 2015/863

REACH Directive - EC/1907/2006

WEEE Directive - 2012/19/EU

UK:

BS EN 60598-1 and BS 4533-102.1, EN 60598-2-1

Electrical Equipment (Safety) Regulations 2016

Electromagnetic Compatibility Regulations 2016

The Restriction of the Use of Certain Hazardous Substances in Electrical and Electronic Equipment Regulations 2012

The Ecodesign for Energy-Related Products and Energy Information (Amendment) (EU Exit) Regulations 2019

USA/Canada*:

UL STD. I598 / CSA STD. C22.2 NO.250.0

Australia/New Zealand**:

AS/NZS 60598.1 and AS/NZS 60598.2.1

* Does not apply to Rime Ø12 and Rime Wall

** Does not apply to Rime Wall

RIME PENDANT LAMP / Ø 25 CM / 9.8"

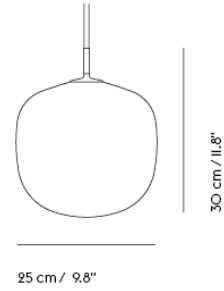

Shipper Colli	1
Gross Weight (kg)	3.4
Net Weight (kg)	1.5
Bulb included	No
Warranty Period	5 years

Pattern No.	Color	Contract Price	Lead Time
Ready-To-Ship US Warehouse			
MRIMPDLP09-BLCK	Black	USD 509.00	-
MRIMPDLP09-WHIT	White	USD 509.00	-
Extras			
MLPCRDGRNP-BLCK	Rime Ø12+Ø25 / Grain Cord - Black (per linear meter)	USD 5.00	-
MLPCRDGRNP-WHIT	Rime Ø12+Ø25 / Grain Cord - White (per linear meter)	USD 5.00	-
MLPCAPL	Ceiling Cap - White	USD 28.00	-

RIME PENDANT LAMP / Ø 37 CM / 14.6"

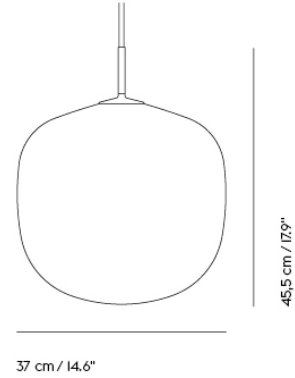

Shipper Colli	1
Gross Weight (kg)	5.25
Net Weight (kg)	3.3
Bulb included	No
Warranty Period	5 years

Pattern No.	Color	Contract Price	Lead Time
Ready-To-Ship US Warehouse			
MRIMPDLP14-BLCK	Black	USD 667.00	-
MRIMPDLP14-WHIT	White	USD 667.00	-
Extras			
MLPCRDRIMP-BLCK	Rime Cord Ø37 + Ø45 cm - Black (per linear meter)	USD 10.00	-
MLPCRDRIMP-WHIT	Rime Cord Ø37 + Ø45 cm - White (per linear meter)	USD 10.00	-
MLPCAPL	Ceiling Cap - White	USD 28.00	-

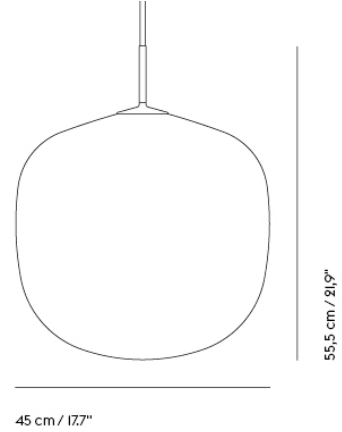

Shipper Colli	1
Gross Weight (kg)	8.5
Net Weight (kg)	4
Bulb included	No
Warranty Period	5 years

Pattern No.	Color	Contract Price	Lead Time
Ready-To-Ship US Warehouse			
MRIMPDLP17-BLCK	Black	USD 902.00	-
MRIMPDLP17-WHIT	White	USD 902.00	-
Extras			
MLPCRDRIMP-BLCK	Rime Cord Ø37 + Ø45 cm - Black (per linear meter)	USD 10.00	-
MLPCRDRIMP-WHIT	Rime Cord Ø37 + Ø45 cm - White (per linear meter)	USD 10.00	-
MLPCAPL	Ceiling Cap - White	USD 28.00	-

SET TABLE LAMP

"A common misconception is that making something new requires new materials, technologies, or production processes. In fact, the most interesting ideas come from looking a bit differently at something very familiar. For this project, I chose to explore the screw thread as a tool for modulation. Adjusting the distance between the reflector and the light source not only dims the light, but also changes the radius of light cast. The result is a lamp able to intuitively shift between illuminating small and larger surfaces."

— Jamie Wolfond



Designed by	Jamie Wolfond
Environment	Indoor
Country of Production	China
Cord Length	250 cm / 98.4"
Light Source Included	Dimmable, integrated, and non-user replaceable LED light designed for Right to Repair which means that only an electrician can replace the light source.
Dimmable Function	Yes
Description	With its distinctive blend of industrial and sculptural design, the Set Lamp features an upward-facing light that shines through an aluminum shade, emitting a bright yet indirect glow. The lamp's adjustable shade height, facilitated by threads on the body, allows for a tactile rotation and enables personalized changes in angle and light intensity. This unique lamp exudes character and seamlessly blends into a variety of spaces—whether placed on the floor, windowsills, sideboards, or any preferred location—making a bold statement as a distinctive centerpiece.
Material	The lamp body and shade are in anodized aluminum. The underside of the shade is powder coated aluminum. Light can be controlled using the inline dimmer or rotating the lamp shade. Dimmable, integrated, and non-user replaceable LED light designed for Right to Repair means that only an electrician can replace the light source. Lumen: 800lm on 100% brightness. Lumen Maintenance (80%) : 50,000h. Kelvin: 2700K. CRI >90.
Cleaning & Care	Clean with a soft, dry cloth only. Always switch off the electricity supply before cleaning.

TESTS & CERTIFICATIONS

EU:

IEC 60598-1 and IEC 60598-2-4
 Low Voltage Directive (LVD) - 2014/35/EU
 ECO Design Directive - 2009/125/EC
 ROHS Directive - 2011/65/EU amended RoHS 3 Directive 2015/863
 REACH Directive - EC/1907/2006
 WEEE Directive - 2012/19/EU

UK:

Electromagnetic Compatibility Regulations 2016
 The Restriction of the Use of Certain Hazardous Substances in Electrical and Electronic Equipment Regulations 2012
 The Ecodesign for Energy-Related Products and Energy Information (Amendment) (EU Exit) Regulations 2019

USA/Canada:

UL STD. I53 and CAN/CSA C22.2 NO.250.4-14

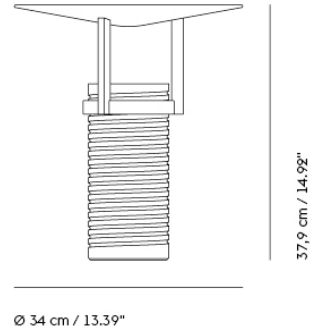

- Shipper Colli 1
- Gross Weight (kg) 9.34
- Net Weight (kg) 6.11
- Bulb included Dimmable, integrated, and non-user replaceable LED
- Warranty Period 5 years

Pattern No.	Color	Contract Price	Lead Time
Ready-To-Ship US Warehouse			
MSETTBLP	Aluminum	USD 1,150.00	-

STRAND LAMP SERIES

"The Strand Pendant Lamp is formed from a sprayed cocoon material with its cloud-like appearance that tightly clings to a spinning steel frame. It consists of tiny strands for a complex, intriguing structure that shrouds the light source while acting as its diffuser. With its see-through expression, the cocoon material allows for the Strand Pendant Lamp to filter light for a warm, comfortable glow. Designed in various sizes and shapes, the Strand Pendant Lamp hovers lightly in space, bringing comfort, harmony and a refined sensitivity into any room."

— Benjamin Hubert



Designed by	Benjamin Hubert
Environment	Indoor
Country of Production	Italy
Cord Length	Ø28 & Ø40: 300 cm / 118.1" Ø45, Ø60 & Ø80: 500 cm / 196.9" Table: 250 cm / 98.4"
Light Source Included	No
Dimmable Function	Yes - if dimmable bulb is used
Socket Size	E26
Ceiling Cap Included	Yes
Description	<p>The Strand Pendant Lamp is designed with soft, playful forms for a modern expression. The design provides both diffused lighting and direct lighting, the latter through its top and bottom opening. The design is made in a sprayed cocoon material that consists of tiny strands for a complex, intriguing structure that, paired with its modern form, gives the Strand Pendant Lamp an almost cloud-like appearance. With its cocoon material filtering light through for a warm, comfortable glow, the Strand Pendant Lamp hovers lightly in space, bringing comfort, harmony and a refined sensitivity to any room.</p> <p>The Strand Table Lamp references design history while remaining distinctly modern. Its shape is soft and playful, a sculptural design fitted with a hidden light source that illuminates the whole of its monolithic form. The lamp is made in a sprayed cocoon material that consists of tiny strands for a complex, intriguing structure that gives the Strand Table Lamp an almost cloud-like appearance. Filtering light through for a warm, comfortable glow, it brings a sense of comfort, harmony and a refined sensitivity to any room.</p>
Material	<p>The Strand Pendant Lamp is made of a cocoon layer with an inner steel structure, a PVC cord and PVC covered steel wire.</p> <p>The Strand Table Lamp is made of a cocoon layer with inner steel structure, base in iron and aluminum, PVC cord with inline dimmer.</p>
Cleaning & Care	Clean with soft dry cloth only. Always switch off the electricity supply before cleaning.
Additional info	Please note that the Open Ø60, Closed Ø45, Ø60 and Ø80 come with a wire suspension system with three metal wires. Metal wires 490 cm. Cord length 500 cm. Total possible suspension length from ceiling 480 cm.

TESTS & CERTIFICATIONS

EU:

IEC 60598-1

Low Voltage Directive (LVD) - 2014/35/EU

ECO Design Directive - 245/2009/EC

ROHS Directive - 2011/65/EU amended RoHS 3 Directive 2015/863

REACH Directive - EC/1907/2006

WEEE Directive - 2012/19/EU

Strand Pendant Lamp:

IEC 60598-2-1

Strand Table Lamp:

IEC 60598-2-4

UK:

BS EN 60598-1

Electrical Equipment (Safety) Regulations 2016

Electromagnetic Compatibility Regulations 2016

The Restriction of the Use of Certain Hazardous Substances in Electrical and Electronic Equipment Regulations 2012

The Ecodesign for Energy-Related Products and Energy Information (Amendment) (EU Exit) Regulations 2019

Strand Pendant Lamp:

BS 4533-102.1 and EN 60598-2-1

Strand Table Lamp:

BS EN 60598-2-4

USA/Canada:

Strand Pendant Lamp:

UL STD. 1598 / CSA STD. C22.2 NO.250.0

Strand Table Lamp:

UL STD. 153 / CAN/CSA C22.2 NO.250.4-14

Australia/New Zealand:

Strand Pendant Lamp:

AS/NZS 60598.1 and AS/NZS 60598.2.1

Strand Table Lamp:

AS/NZS 60598.1 and AS/NZS 60598.2.4

The Eurasian Economic Union:*

TP TC 004 and TP TC 020

China:*

GB 7000.201 and GB 7000.1

* Does not apply to Strand Table Lamp

STRAND PENDANT LAMP / OPEN - Ø 28 CM / 11"

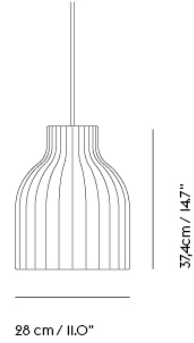

Shipper Colli 1
Gross Weight (kg) 2.35
Net Weight (kg) 1.4
Bulb included No
Warranty Period 5 years

Pattern No.	Color	Contract Price	Lead Time
Ready-To-Ship US Warehouse			
MSTRPDLPO11	White - Open	USD 534.00	-

STRAND PENDANT LAMP / OPEN Ø 40 CM / 16"

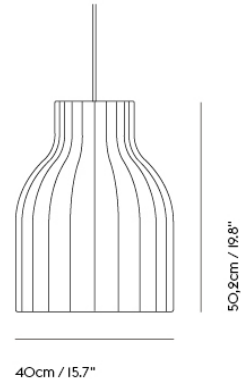

- Shipper Colli 1
- Gross Weight (kg) 3.7
- Net Weight (kg) 2.1
- Bulb included No
- Warranty Period 5 years

Pattern No.	Color	Contract Price	Lead Time
Ready-To-Ship US Warehouse			
MSTRPDLPO16	White - Open	USD 719.00	-

STRAND PENDANT LAMP / OPEN - Ø 60 CM / 23.5"

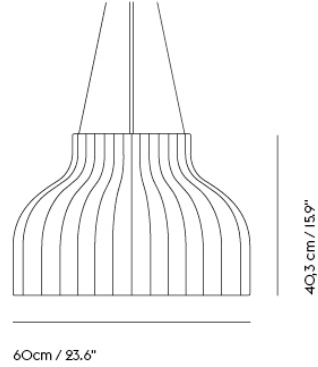

Shipper Colli 1
Gross Weight (kg) 6.6
Net Weight (kg) 4.05
Bulb included No
Warranty Period 5 years

Pattern No.	Color	Contract Price	Lead Time
Ready-To-Ship US Warehouse			
MSTRPDLPO23	White - Open	USD 992.00	-

STRAND PENDANT LAMP / CLOSED Ø 45 CM / 17.7"

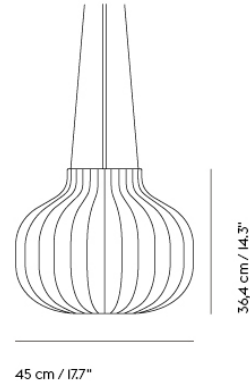

Gross Weight (kg)	4.45
Net Weight (kg)	2.75
Bulb included	No
Warranty Period	5 years

Pattern No.	Color	Contract Price	Lead Time
Ready-To-Ship US Warehouse			
MSTRPDLPC17	White - Closed - Ø 17.7"	USD 1,013.00	-

**STRAND PENDANT LAMP / CLOSED - Ø
60 CM / 23.5"**

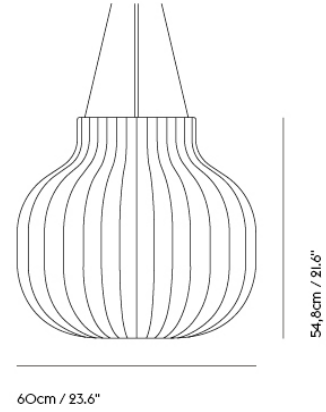

- Shipper Colli 1
- Gross Weight (kg) 8.4
- Net Weight (kg) 5.4
- Bulb included No
- Warranty Period 5 years

Pattern No.	Color	Contract Price	Lead Time
Ready-To-Ship US Warehouse			
MSTRPDLPC23	White - Closed	USD 1,101.00	-

**STRAND PENDANT LAMP / CLOSED - Ø
80 CM / 31.5"**

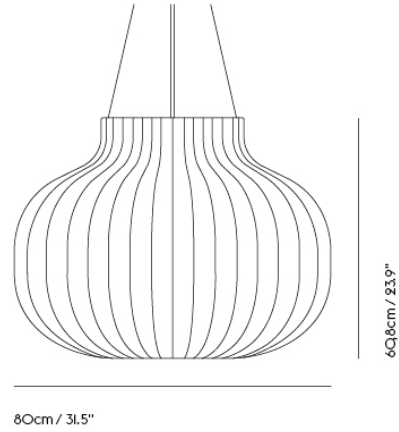

Shipper Colli 1
Gross Weight (kg) 11.05
Net Weight (kg) 6.35
Bulb included No
Warranty Period 5 years

Pattern No.	Color	Contract Price	Lead Time
Ready-To-Ship US Warehouse			
MSTRPDLPC31	White - Closed	USD 1,360.00	-

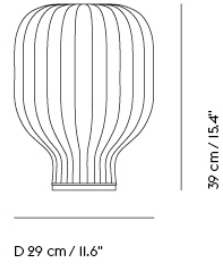

Shipper Colli 1
Gross Weight (kg) 5
Net Weight (kg) 2.9
Bulb included No
Warranty Period 5 years

Pattern No.	Color	Contract Price	Lead Time
Ready-To-Ship US Warehouse			
MSTRTBLP15	White	USD 797.00	-

TIP LAMP SERIES

"The Tip Lamp Series is a simplistic and friendly design featuring a characteristic architectural silhouette. During the design process, we focused on polishing every single detail alongside the design's functionality. I wanted to reduce the design to the very essence of its purpose—intending to create a product that anyone would understand and be able to use in their daily lives. Its molded body gives the Tip Lamp Series a clean and precise look, highlighting its appearance of quality."

— Jens Fager



Designed by	Jens Fager
Environment	Indoor
Country of Production	China
Cord Length	250 cm / 98.5"
Light Source Included	Yes - integrated non-replaceable LED
Dimmable Function	Yes
Description	Created from the idea of stripping a design down to its essentials, the Tip Lamp Series is an example of simple, functional design with careful attention to detail. Offering direct as well as ambient light, the lamp's adjustable head feature an opal diffuser and dimmer function that effortlessly alters the volume of light.
Material	Casted and extruded powder coated aluminum. PVC cord. Tip Wall Lamp backplate in injection-molded plastic. Wall bracket in chrome steel. LED bulb with a Lumen maintenance (Lifetime) of L90 BIO 35.000 hours.
Cleaning & Care	Clean with soft dry cloth only. Always switch off the electricity supply before cleaning.

TESTS & CERTIFICATIONS

EU:

Tip Table / Tip Floor: IEC 60598-1 and IEC 60598-2-4

Tip Wall: IEC 60598-1 and IEC 60598-2-1

Low Voltage Directive (LVD) - 2014/35/EU

ECO Design Directive - 245/2009/EC

ROHS Directive - 2011/65/EU amended RoHS 3 Directive 2015/863

REACH Directive - EC/1907/2006

WEEE Directive - 2012/19/EU

UK:

Tip Table / Tip Floor: BS EN 60598-1 and EN 60598-2-4

Tip Wall: BS EN 60598-1 and BS 4533-102.1, EN 60598-2-1

Electrical Equipment (Safety) Regulations 2016

Electromagnetic Compatibility Regulations 2016

The Restriction of the Use of Certain Hazardous Substances in Electrical and Electronic Equipment Regulations 2012

The Ecodesign for Energy-Related Products and Energy Information (Amendment) (EU Exit) Regulations 2019

USA/Canada*:

Tip Table & Tip Wall: UL STD. 153 / CSA STD. C22.2 NO.250.4

Tip Wall: UL STD. 1598 / CSA STD. C22.2 NO.250.0

Australia/New Zealand*:

Tip Table & Tip Wall: AS/NZS 60598.1 and AS/NZS 60598.2.4

Tip Wall: AS/NZS 60598.1 and AS/NZS 60598.2.1

*Does not apply to the following colors: Copper Brown, Grey and Light Green.

*Does not apply to Tip Floor Lamp



Shipper Colli	1
Gross Weight (kg)	2.4
Net Weight (kg)	1.5
Bulb included	Yes. Integrated non-replaceable LED
Warranty Period	5 years

Pattern No.	Color	Contract Price	Lead Time
Ready-To-Ship US Warehouse			
MTIPTBLP-BLCK	Black	USD 492.00	-
MTIPTBLP-CPBN	Copper Brown	USD 492.00	-
MTIPTBLP-OLIV	Olive	USD 492.00	-
MTIPTBLP-WHIT	White	USD 492.00	-

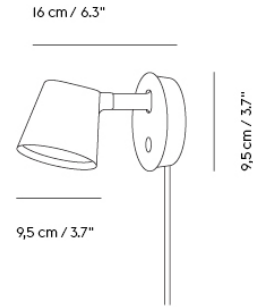

Shipper Colli |
Gross Weight (kg) 0.75
Net Weight (kg) 0.45
Bulb included Yes. Integrated non-replaceable LED
Warranty Period 5 years

Pattern No.	Color	Contract Price	Lead Time
Ready-To-Ship US Warehouse			
MTIPWLLP-BLCK	Black	USD 331.00	-
MTIPWLLP-GREY	Grey	USD 331.00	-
MTIPWLLP-WHIT	White	USD 331.00	-

UNDER THE BELL PENDANT LAMP

"Under The Bell is more than just a lampshade—when situated over a table or in an open space, the bell-shaped light creates its own space within the environment. As such, the design embraces and shelters the people underneath, both in a physical and abstract manner, for an intimate atmosphere. The design is made using fibers from recycled plastic bottles that, along with its unique shape, enables Under The Bell to absorb sound and improve the acoustics of any room."

— Iskos-Berlin



Design by	Iskos-Berlin
Environment	Indoor
Country of Production	Germany
Cord Length	500 cm / 197"
Light Source Included	No
Dimmable Function	Yes - if dimmable bulb is used
Socket Size	E26
Ceiling Cap Included	Yes
Description	Designed in a material that uses up to 41% fibers from recycled plastic bottles, the Under The Bell Pendant Lamp not only brings a tactile and modern expression to any space but also impacts the acoustics of a room through its soft shade, paired with its graphic lines and subtle color palette.
Material	Shade made using up to 41% fibers from recycled plastic bottles. Rubber cord.
Cleaning & Care	Vacuum to remove dust. Clean off any marks with a clean moist cloth. Always switch off the electricity supply before cleaning.

UNDER THE BELL PENDANT LAMP

TESTS & CERTIFICATIONS

EU:

IEC 60598-1 and IEC 60598-2-1

Low Voltage Directive (LVD) - 2014/35/EU

ECO Design Directive - 245/2009/EC

ROHS Directive - 2011/65/EU amended RoHS 3 Directive 2015/863

REACH Directive - EC/1907/2006

WEEE Directive - 2012/19/EU

UK:

BS EN 60598-1 and BS 4533-102.1, EN 60598-2-1

Electrical Equipment (Safety) Regulations 2016

Electromagnetic Compatibility Regulations 2016

The Restriction of the Use of Certain Hazardous Substances in Electrical and Electronic Equipment Regulations 2012

The Ecodesign for Energy-Related Products and Energy Information (Amendment) (EU Exit) Regulations 2019

USA/Canada:

UL STD. 1598 / CSA STD. C22.2 NO.250.0

Australia/New Zealand:

AS/NZS 60598.1 and AS/NZS 60598.2.1

The Eurasian Economic Union:

TP TC 004 and TP TC 020

China:

GB 7000.201 and GB 7000.1

UNDER THE BELL PENDANT LAMP / Ø 55 CM / 21.7"

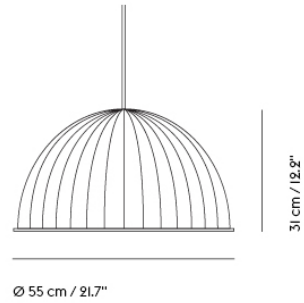

Shipper Colli	1
Gross Weight (kg)	2.35
Net Weight (kg)	1.15
Bulb included	No
Warranty Period	5 years

Pattern No.	Color	Contract Price	Lead Time
-------------	-------	----------------	-----------

Ready-To-Ship US Warehouse

MUTBPDLPSP-BLCK	Black	USD 761.00	-
MUTBPDLPSP-DKGN	Dark Green	USD 761.00	-
MUTBPDLPSP-GREY	Grey	USD 761.00	-
MUTBPDLPSP-WHME	White Mélange	USD 761.00	-

Extras

MLPCRDUTBP-BLCK	Under the Bell Cord - Black (per linear meter)	USD 4.00	-
MLPCRDUTBP-DKGN	Under the Bell Cord - Dark Green (per linear meter)	USD 4.00	-
MLPCRDUTBP-GREY	Under the Bell Cord - Grey (per linear meter)	USD 4.00	-
MLPCRDUTBP-WHME	Under the Bell Cord - White Mélange (per linear meter)	USD 4.00	-
MLPCAPL	Ceiling Cap - White	USD 28.00	-

UNDER THE BELL PENDANT LAMP / Ø 82 CM / 32.25"

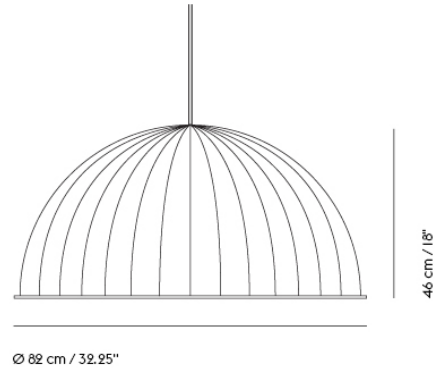

Shipper Colli	1
Gross Weight (kg)	4.95
Net Weight (kg)	2.35
Bulb included	No
Warranty Period	5 years

Pattern No.	Color	Contract Price	Lead Time
Ready-To-Ship US Warehouse			
MUTBPDPLG-BLCK	Black	USD 933.00	-
MUTBPDPLG-DKGN	Dark Green	USD 933.00	-
MUTBPDPLG-GREY	Grey	USD 933.00	-
MUTBPDPLG-WHME	White Mélange	USD 933.00	-
Extras			
MLPCRDUTBP-BLCK	Under the Bell Cord - Black (per linear meter)	USD 4.00	-
MLPCRDUTBP-DKGN	Under the Bell Cord - Dark Green (per linear meter)	USD 4.00	-
MLPCRDUTBP-GREY	Under the Bell Cord - Grey (per linear meter)	USD 4.00	-
MLPCRDUTBP-WHME	Under the Bell Cord - White Mélange (per linear meter)	USD 4.00	-
MLPCAPL	Ceiling Cap - White	USD 28.00	-

UNFOLD PENDANT LAMP

“We wanted to bring a new perspective to the classic industrial light with the Unfold Pendant Lamp, creating an expression that is at once timeless and modern. To achieve this, the design comes in a rubber silicone material for a playful and tactile character along with a matte touch. With its modern and flexible material, the Unfold Pendant Lamp can be folded into a flat box for eco-friendly shipping and a contemporary look.”

— Form Us With Love



Designed by	Form Us With Love
Environment	Indoor
Country of Production	China
Cord Length	350 cm / 137.8"
Light Source Included	No
Dimmable Function	Yes - if dimmable bulb is used
Socket Size	E26
Ceiling Cap Included	Yes
Description	A quirky take on the industrial pendant lampshade, the Unfold Pendant Lamp is useful in any home or professional space. Made of soft silicone rubber, the pendant is available in a wide range of colors to brighten up any room.
Material	Shade in silicone rubber, PVC cord. Diffuser clear frosted opal acrylic material. The shade is pressed in vulcanised rubber under high temperature. Diffuser and socket holder cut by laser.
Cleaning & Care	Clean with soft dry/wet cloth. Always switch off the electricity supply before cleaning.

TESTS & CERTIFICATIONS

EU:

IEC 60598-1 and IEC 60598-2-1

Low Voltage Directive (LVD) - 2014/35/EU

ECO Design Directive - 245/2009/EC

ROHS Directive - 2011/65/EU amended RoHS 3 Directive 2015/863

REACH Directive - EC/1907/2006

WEEE Directive - 2012/19/EU

UK:

BS EN 60598-1 and BS 4533-102.1, EN 60598-2-1

Electrical Equipment (Safety) Regulations 2016

Electromagnetic Compatibility Regulations 2016

The Restriction of the Use of Certain Hazardous Substances in Electrical and Electronic Equipment Regulations 2012

The Ecodesign for Energy-Related Products and Energy Information (Amendment) (EU Exit) Regulations 2019

USA/Canada:

UL STD. 1598 / CSA STD. C22.2 NO.250.0

Australia/New Zealand:

AS/NZS 60598.1 and AS/NZS 60598.2.1

The Eurasian Economic Union:

TP TC 004 and TP TC 020

China:

GB 7000.201 and GB 7000.1

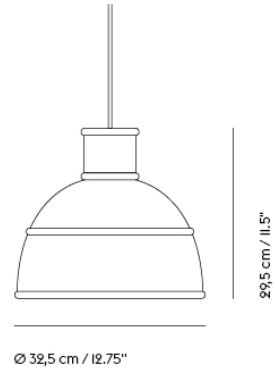

Shipper Colli	1
Gross Weight (kg)	1.8
Net Weight (kg)	1.26
Bulb included	No
Warranty Period	5 years

Pattern No.	Color	Contract Price	Lead Time
Ready-To-Ship US Warehouse			
MUNFPDLP-BEGN	Beige-Green	USD 362.00	-
MUNFPDLP-BERO	Beige-Rose	USD 362.00	-
MUNFPDLP-BLCK	Black	USD 362.00	-
MUNFPDLP-BURG	Burgundy	USD 362.00	-
MUNFPDLP-DKGY	Dark Grey	USD 362.00	-
MUNFPDLP-DRED	Dusty Red	USD 362.00	-
MUNFPDLP-GREN	Green	USD 362.00	-
MUNFPDLP-LIGY	Light Grey	USD 362.00	-
MUNFPDLP-MSTD	Mustard	USD 362.00	-
MUNFPDLP-OLIV	Olive	USD 362.00	-
MUNFPDLP-TERR	Terracotta	USD 362.00	-
MUNFPDLP-WHIT	White	USD 362.00	-
MUNFPDLP-YELW	Yellow	USD 362.00	-

Extras

MLPCRDUUNFP-BERO	Unfold Cord - Beige-Rose (per linear meter)	-
MLPCRDE27P-BLCK	Unfold / E27 Cord - Black (per linear meter)	USD 4.00
MLPCRDE27P-OLIV	Unfold / E27 Cord - Olive (per linear meter)	USD 4.00
MLPCRDE27P-TERR	Unfold Cord - Terracotta (per linear meter)	USD 4.00
MLPCRDUUNFP-ORNG	Unfold / E27 Cord - Orange (per linear meter)	USD 5.00
MLPCRDUUNFP-BEGN	Unfold Cord - Beige-Green (per linear meter)	USD 5.00

Pattern No.	Color	Contract Price	Lead Time
MLPCRDUNFP-BURG	Unfold Cord - Burgundy (per linear meter)	USD 5.00	-
MLPCRDUNFP-CLBW	Unfold Cord - Clay Brown (per linear meter)	USD 5.00	-
MLPCRDUNFP-DKGY	Unfold Cord - Dark Grey (per linear meter)	USD 5.00	-
MLPCRDUNFP-DRED	Unfold Cord - Dusty Red (per linear meter)	USD 5.00	-
MLPCRDUNFP-GREN	Unfold Cord - Green (per linear meter)	USD 5.00	-
MLPCRDUNFP-YELW	Unfold Cord - Yellow (per linear meter)	USD 5.00	-
MLPCAPL	Ceiling Cap - White	USD 28.00	-

ACCESSORIES

AMPLE THROW

"The Ample Throw is about comfort. Being rich and soft, the design is made in baby llama wool that has been lovingly knit—the best of nature, translated into a deeply refined comfort."

— Aiayu

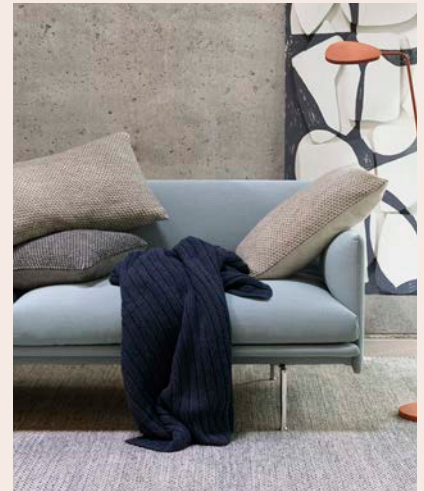

Designed by	Aiayu
Environment	Indoor
Country of Production	Bolivia
Description	<p>With its plentiful character and simple surface, the Ample Throw—designed by Copenhagen-based designers Aiayu—brings large comfort and warmth to its user. The throw is made in 100% baby llama wool, a light and ultra-soft material with heat-controlling abilities that will keep you warm on winter mornings and cool you down on summer nights.</p> <p>The wool has been sourced in Bolivia with the factory cleaning 100% of its water post-production while reusing 75% of it. The factory also holds the WRAP-certification, ensuring production under lawful, humane and ethical conditions.</p>
Material	The Ample Throw is made from 100% baby llama wool.
Cleaning & Care	<p>This product is made from 100% baby llama wool - a self-cleaning fiber that requires less washing than other materials. Simply air your product at first. If the need to wash it arises, hand wash is recommended at 30 degrees C using high-quality soap. Soak the product in water for 10 - 15 minutes before rinsing it in 30 degrees C water. Avoid twisting or pressing the water out. Let the product dry flat.</p>

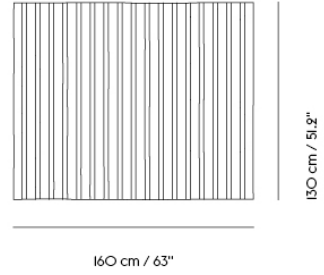

Shipper Colli 1
Gross Weight (kg) 1.6
Net Weight (kg) 1.5
Warranty Period 5 years

Pattern No.	Color	Contract Price	Lead Time
Ready-To-Ship US Warehouse			
MAMPTH-DKGY	Dark Grey	USD 541.00	-
MAMPTH-MBLU	Midnight Blue	USD 541.00	-

ARCED MIRROR

"The Arced Mirror's characteristic shape is both angular and rounded, blending my research on material extrusions with the classical shape of windows I see on my way to work in Sydney. I wanted to take a form that fits in a variety of environments, and put a subtle twist on it: the milled details and stained wood material make for a modern interpretation on a traditional form. That gives it a sense of familiarity whilst being pared back and sophisticated."

— Rhys Copper



Designed by	Rhys Copper
Environment	Indoor
Contry of Production	Slovenia
Description	Blending a traditional wooden mirror style with a modern touch, the Arced Mirror comes in two versatile sizes and features a subtle frame recess, giving it a charming window-like allure. The mirror is treated with a wood stain color and finished with a clear matte lacquer that brings forth the natural character and grain of the spruce wood. Available in three colors— Light Grey, Light Green, and Light Lilac, each offering a distinct and unique expression.
Material	Frame made from FSC™-certified (FSC-CO28824) spruce wood. Clear mirror glass. The spruce wood frame is treated with a wood stain color and finished with a clear matte lacquer. The backside is enclosed by a black backboard.
Cleaning & Care	To avoid damage from oxidation, please do not hang the Arced Mirror in surroundings with wet elements or high humidity, such as bathrooms or outdoors. To clean the Arced Mirror, use a mild glass spray and wipe with a soft, dry cloth immediately after spraying. Do not use acids or alkaline cleaning products. Ensure the areas between the frame and glass are dry. Avoid spraying the spruce wood frame. Make sure that the mirror is dry when cleaning is done.

TESTS & CERTIFICATIONS

Forest Stewardship Council™ Frame made from FSC™-certified (FSC-CO28824) wood.

ARCED MIRROR / 80 X 55 CM / 31.5 X 21.65"

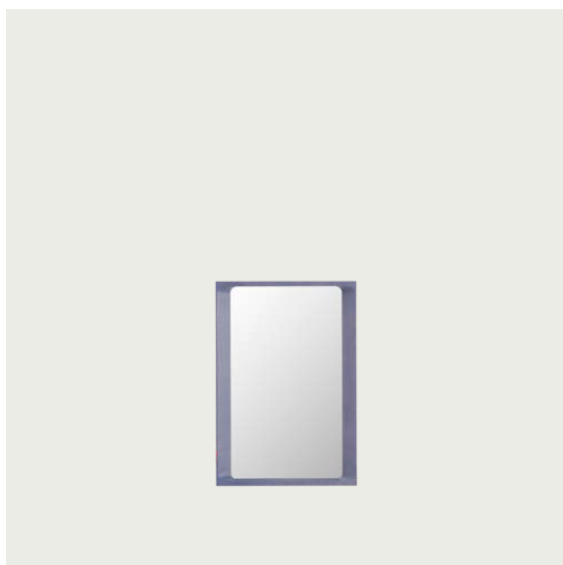

Shipper Colli	I
Gross Weight (kg)	11
Net Weight (kg)	8.5
Warranty period	5 years

Pattern No.	Color	Contract Price	Lead Time
Ready-To-Ship EU Warehouse			
MARCMIR3222-LGRN	Light Green	USD 929.00	-
MARCMIR3222-LLIL	Light Lilac	USD 929.00	-

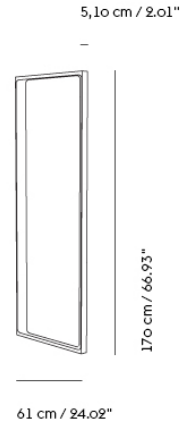
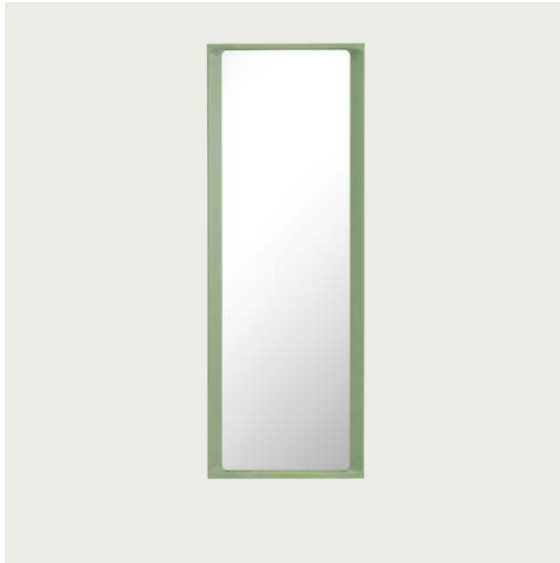

Shipper Colli 1
Gross Weight (kg) 24
Net Weight (kg) 19.5
Warranty period 5 years

Pattern No.	Color	Contract Price	Lead Time
Ready-To-Ship EU Warehouse			
MARCMIR6724-LGRN	Light Green	USD 1,731.00	-
MARCMIR6724-LLIL	Light Lilac	USD 1,731.00	-

ATTACH COAT HOOK

"The Attach Coat Hook arose from an interest in the meeting of two elementary shapes: a cylinder and a rectangular box. From there, the design was created by combining a simple wood cylinder with an anodized aluminum form, joining together industrial and natural materiality. With its contrasting elements, the Attach Coat Hook brings a refined yet sturdy perspective to the modern coat hook."

— Dimitri Bähler



Designed by	Dimitri Bähler
Environment	Indoor
Country of Production	China
Description	The Attach Coat Hook combines industrial and Scandinavian materialities for a playful yet refined take on the simple, modern coat hook, joined by its contrasting round and square forms. Use the design in linear formations for a simple, refined expression or in more vibrant layouts with various colors of the design.
Material	The Attach Coat Hook is made from oak and aluminum, colored with PVD vacuum-treated surface.
Cleaning & Care	Clean with moist cloth, If necessary use a mild detergent. Wipe the surface dry with a lint-free cloth

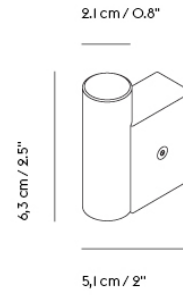

Shipper Colli 1
Gross Weight (kg) 0.24
Net Weight (kg) 0.2
Warranty Period 5 years

Pattern No.	Color	Contract Price	Lead Time
Ready-To-Ship US Warehouse			
MATTCH-ALUM	Oak/Aluminum - Set of 2	USD 89.00	-
MATTCH-BLCK	Oak/Black - Set of 2	USD 89.00	-
MATTCH-BORG	Oak/Burnt Orange - Set of 2	USD 89.00	-
MATTCH-DKGN	Oak/Dark Green - Set of 2	USD 89.00	-
MATTCH-PABU	Oak/Pale Blue - Set of 2	USD 89.00	-

AVAIL COAT RACK

“The emphasis for the Avail Coat Rack was not necessarily to create something different but rather something better—a design that will last for years and give satisfaction in daily life. Through its hooks that can be continuously rearranged while adding notes of color to the warm touch of its oak surface, the Avail Coat Rack evolves with our changing daily needs and reflects our perspectives with its small plateau upon which smaller objects can be placed.”

— Sam Hect & Kim Collin



Designed by	Sam Hect & Kim Collin
Environment	Indoor
Country of Production	Slovenia
Assembly Required	Yes
Description	Designed with Scandinavian materiality at its heart, the Avail Coat Rack brings the ideas of simplicity and functionality into the modern home. The design features 2 metal hooks that can be rearranged forever while also bringing hints of color to the form, allowing for the Avail Coat Rack to evolve as time passes while holding smaller objects on its minute plateau.
Materials	Rack and dots in FSC™-certified (FSC-CO28824) oak that is either oiled or lacquered. Hooks in powder coated steel.
Cleaning & care	Plastic or powder coated surfaces: Clean with a moist cloth. If necessary use a little dish soap on the cloth. Wood and Veneer surfaces: Clean the table with a damp cloth. If necessary only use a mild detergent or washing up liquid and not concentrated. Always wipe with a dry cloth afterwards. To minimize the risk of stains and marks, liquid, grease etc. should be removed straight away.
Forest Stewardship Council™	TESTS & CERTIFICATIONS Rack and dots are made from FSC™-certified (FSC-CO28824) wood.

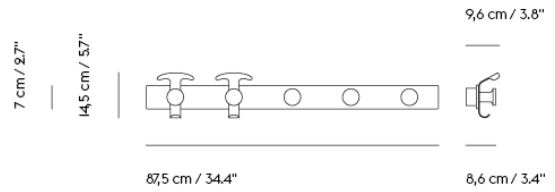
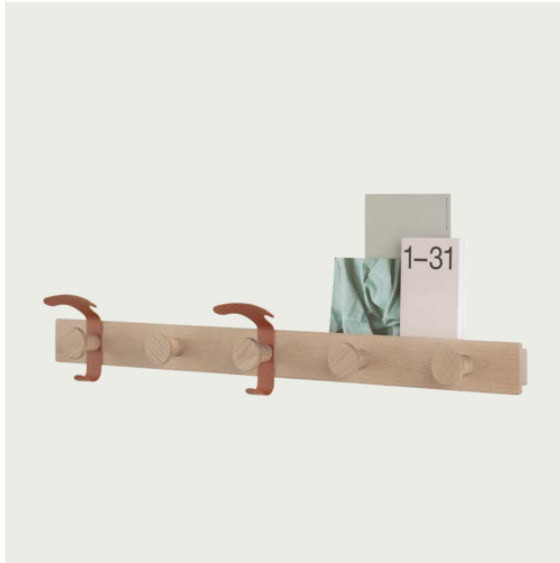

Shipper Colli 1
Gross Weight (kg) 3.14
Net Weight (kg) 2.26
Warranty Period 5 years

Pattern No.	Color	Contract Price	Lead Time
Ready-To-Ship US Warehouse			
MPLCTRK-GREY-GREY	Grey/Grey	USD 278.00	-
MPLCTRK-OAK-BLCK	Oak/Black	USD 278.00	-
MPLCTRK-OAK-GREY	Oak/Grey	USD 278.00	-
MPLCTRK-OAK-CPBN	Oak/Copper Brown	USD 278.00	-

COIL COAT RACK

"Design often finds its function first and its form second. With the Coil Coat Rack, this process was reversed. While I was modeling some ideas by forming paper into different shapes, I realized that the curling form of a rolled-up paper could be combined with hooks and be ideal for a coat rack. With its soft lines and sliding hooks that can be adjusted to one's individual preferences, the Coil Coat Rack is a functionally inviting perspective on the archetypal coat rack."

— Lars Tornøe



Designed by	Lars Tornøe
Environment	Indoor
Contry of Production	China
Description	The Coil Coat Rack finds its new perspective through its coil-shaped form along with its hooks that are brought into play for a simple yet characterful element that breathes function into the design. The design allows for the user to buy additional hooks if needed to make the Coil Coat Rack uniquely theirs. The shape of the design is inspired by the curled-up form of rolled paper.
Material	Anodized aluminum
Cleaning & Care	Clean with moist cloth, If necessary use a mild detergent. Wipe the surface dry with a lint-free cloth
Spare Parts	Hooks

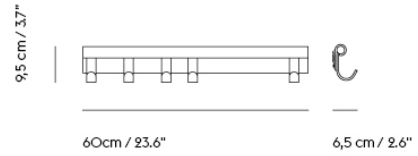

Shipper Colli 1
 Gross Weight (kg) 2
 Net Weight (kg) 1.4
 Warranty Period 5 Years

Pattern No.	Color	Contract Price	Lead Time
Ready-To-Ship US Warehouse			
MCCTR24-BLCK	Black	USD 251.00	-
MCCTR24-DKGN	Dark Green	USD 251.00	-
MCCTR24-PLUM	Plum	USD 251.00	-
Extras			
MCCTRH-BLCK	Extra Coat Hook - Black	USD 36.00	-
MCCTRH-DKGN	Extra Coat Hook - Dark Green	USD 36.00	-
MCCTRH-PLUM	Extra Coat Hook - Plum	USD 36.00	-

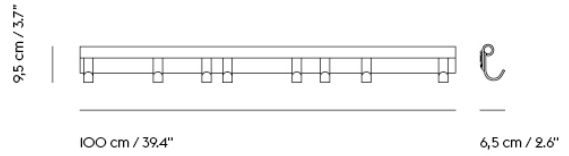

Shipper Colli 1
 Gross Weight (kg) 3.3
 Net Weight (kg) 2.4
 Warranty Period 5 Years

Pattern No.	Color	Contract Price	Lead Time
Ready-To-Ship US Warehouse			
MCCTR39-BLCK	Black	USD 482.00	-
MCCTR39-DKGN	Dark Green	USD 482.00	-
MCCTR39-PLUM	Plum	USD 482.00	-
Extras			
MCCTRH-BLCK	Extra Coat Hook - Black	USD 36.00	-
MCCTRH-DKGN	Extra Coat Hook - Dark Green	USD 36.00	-
MCCTRH-PLUM	Extra Coat Hook - Plum	USD 36.00	-

COMPILE BOOKEND

"The Compile Bookend adds a sculptural feature to your shelving system, with clear lines and multiple display options for your favorite books and magazines. The bookend supports itself, ensuring unrestricted movement and creative freedom of use. It serves as a functional element, adding color and character to shelves at home or in the office."

— Cecilie Manz



Designed by	Cecilie Manz
Environment	Indoor
Country of Production	Sweden
Description	The Compile Bookend is an elegant compliment to any bookshelf, windowsill or desk. It can be placed in several positions to accommodate books of differing sizes. With its clean geometric shape and various colors, the Compile Bookend brings a refined statement to any scenery.
Material	Made from laser cut steel sheets, bent to form, and then coated with high quality powder.
Cleaning & Care	Clean with moist cloth.

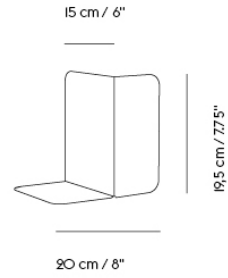

Shipper Colli 1
Gross Weight (kg) 1.026
Net Weight (kg) 0.8
Warranty Period 5 years

Pattern No.	Color	Contract Price	Lead Time
Ready-To-Ship US Warehouse			
MCOMBK-GNBE	Beige-Green	USD 58.00	-
MCOMBK-GREY	Grey	USD 58.00	-
MCOMBK-PLUM	Plum	USD 58.00	-

CORKY SERIES

"The shape of the Corky Carafe is inspired by the archetypal bottle. It is a straightforward combination of glass and cork that functions equally well as a wine carafe, a water jug or even a milk bottle. Corky has a simple and familiar form but with a characteristic and oversized detail. The Corky glasses are small and light companions for the Corky carafe. With a low-key and light expression, they are suited for both everyday use and special occasions with friends and family."

— Andreas Engesvik



Designed by	Andreas Engesvik
Environment	Indoor
Country of Production	China
Description	The Corky Carafe and Glasses are simple and light; a contemporary yet timeless design that will look good in any kitchen, dining area, office or restaurant. The glasses come in two sizes and two colors.
Material	Corky carafe and drinking glasses are mouth-blown and hand-polished. Cork stopper for the Corky Carafe in granulated cork.
Cleaning & Care	Normal hand wash is recommended. Dishwasher approved at maximum 55°C. Wash Cork Stopper in cold water. Not suitable for hot beverages.

TESTS & CERTIFICATIONS

European Parliament and Council Regulation (EC) 1935/2004/EC

Commission Regulation (EC) No 2023/2006 of 22 December 2006 on good manufacturing practice for materials and articles intended to come into contact with food (GMP)

US Food and Drug Administration (FDA) Title 21 Code of Federal Regulations (CFR, 2011 Edition) as applicable

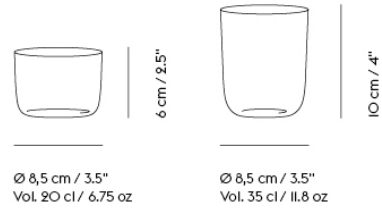

Shipper Colli 1
Gross Weight (kg) 0.7
Net Weight (kg) 0.66
Warranty Period 5 years

Pattern No.	Color	Contract Price	Lead Time
Ready-To-Ship US Warehouse			
MCRKGLL-CLR	Clear - Low	USD 89.00	-
MCRKGLL-GREY	Grey - Low	USD 89.00	-
MCRKGLT-CLR	Clear - Tall	USD 100.00	-
MCRKGLT-GREY	Grey - Tall	USD 100.00	-

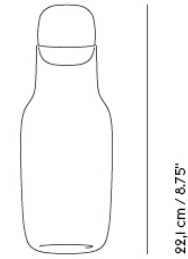

Ø 99 cm / 4"
Vol. 1 liter / 33.8 oz

Shipper Colli 1
Gross Weight (kg) 1
Net Weight (kg) 0.4
Warranty Period 5 years

Pattern No.	Color	Contract Price	Lead Time
Ready-To-Ship US Warehouse			
MCRKCF-CLR	Clear	USD 100.00	-
MCRKCF-GREY	Grey	USD 100.00	-

DOTS COAT HOOK SERIES

"The Dots are a characteristic family of hooks that make a friendly addition to any wall. With their smooth, round edges, they will treat your items with the greatest of care. Designed in multiple sizes, materials and colors, the Dots Coat Hook Series can be arranged in any pattern imaginable to express your personal taste. Oh, and feel free to add more as time goes on: Thats love to welcome one another on the wall."

— Lars Tornøe

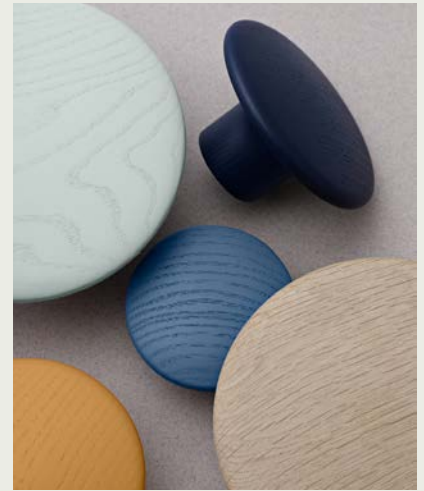

Designed by	Lars Tornøe
Environment	Indoor
Contry of Production	Wood: Slovenia / Metal: China / Ceramic: Portugal
Description	Bringing a friendly expression to the traditional coat hook, the Dots Series is a functionally sculptural design to be arranged on the wall in any pattern and color combination desired. Use it in hallways, bedrooms, kitchens as well as hospitality and workplace areas. Combine the Dots Ceramic, Dots Metal and Dots Wood for a unique expression. Visit our Product Planner to explore the possible configurations: planner.muuto.com/dots
Material	<p>The Dots Ceramic: Made from earthenware with glaze. The Dots Ceramic is made in an organic material. The surface is made with a reactive glaze, giving each single Dots Ceramic a unique expression. Slight color variations may appear as a natural characteristic of the design's materiality.</p> <p>The Dots Metal: Made from anodized solid aluminum. Produced on a CNC lathing machine, carefully lacquered and packed.</p> <p>The Dots Wood: Made from first class oiled oak, walnut and ash wood (colored versions in ash wood). The wood has been carefully selected for this product, as a knot will ruin the design of the product. The wood is cut, glued together in two pieces and processed in a CNC turning lathe. Polished and oiled. This product is made in an organic material. Natural variations in the surface and color can occur as a result of this, giving each single product a unique expression.</p>
Cleaning & Care	<p>Dots Wood & Ceramic Clean with moist cloth.</p> <p>Dots Metal Clean with moist cloth, If necessary use a mild detergent. Wipe the surface dry with a lint-free cloth</p>
Spare part	1 x Mounting screw for each Dots Coat Hook

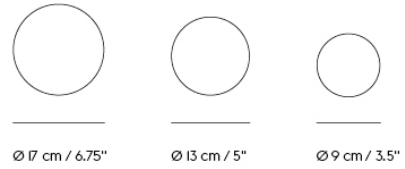
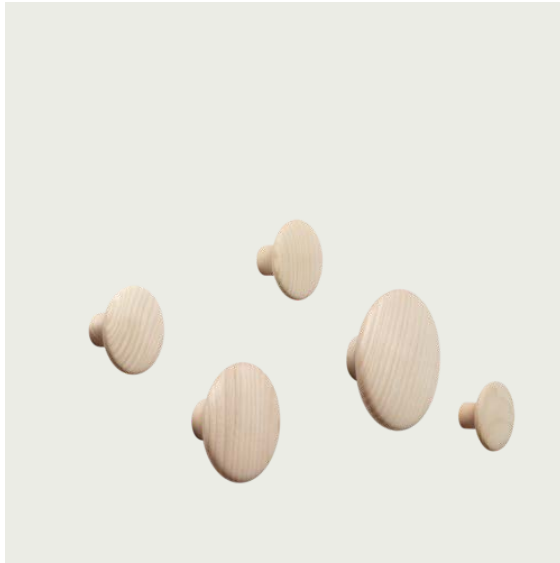

Shipper Colli 1
Gross Weight (kg) 1.2
Net Weight (kg) 0.77
Set of 5 Consists of 1x Ø 17 cm / 6.75", 1x Ø 13 cm / 5" and 3x Ø 9 cm / 3.5"
Warranty Period 5 years

Pattern No.	Color	Contract Price	Lead Time
Ready-To-Ship US Warehouse			
MDOTSWSET-BLCK	Black	USD 156.00	-
MDOTSWSET-GREY	Grey ***	USD 156.00	-
MDOTSWSET-OAK	Oak	USD 156.00	-
MDOTSWSET-OWHT	Off-White	USD 156.00	-
Extras			
MDOTSWC	Screw for Dots Wood and Ceramic	USD 2.00	-

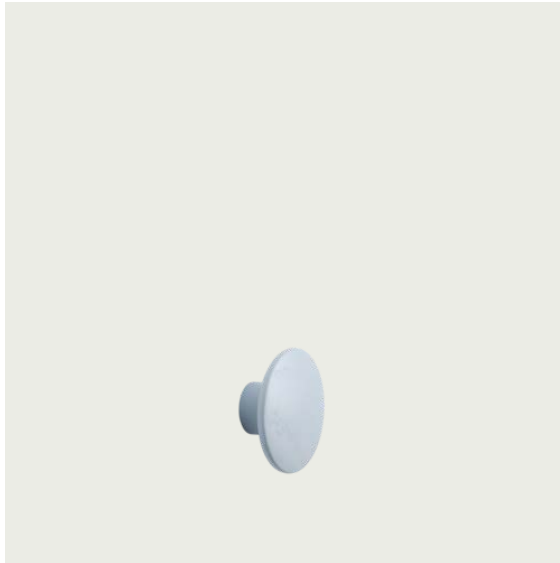

Ø 6,5 cm / 2.5"

Shipper Colli 1
Gross Weight (kg) 0.06
Net Weight (kg) 0.036
Warranty Period 5 years

Pattern No.	Color	Contract Price	Lead Time
Ready-To-Ship US Warehouse			
MDOTSW3-ASH	Ash	USD 27.00	-
MDOTSW3-BLCK	Black	USD 27.00	-
MDOTSW3-BRGR	Brown Green	USD 27.00	-
MDOTSW3-BURG	Burgundy	USD 27.00	-
MDOTSW3-BORG	Burnt Orange	USD 27.00	-
MDOTSW3-DKGN	Dark Green	USD 27.00	-
MDOTSW3-DKGY	Dark Grey	USD 27.00	-
MDOTSW3-DGRN	Dusty Green	USD 27.00	-
MDOTSW3-GREY	Grey	USD 27.00	-
MDOTSW3-LTBU	Light Blue	USD 27.00	-
MDOTSW3-MBLU	Midnight Blue	USD 27.00	-
MDOTSW3-MSTD	Mustard	USD 27.00	-
MDOTSW3-OAK	Oak	USD 27.00	-
MDOTSW3-OWHT	Off-White	USD 27.00	-
MDOTSW3-PABU	Pale Blue	USD 27.00	-
MDOTSW3-PETR	Petroleum	USD 27.00	-
MDOTSW3-SAGN	Sage Green	USD 27.00	-
MDOTSW3-STDB	Stained Dark Brown	USD 27.00	-
MDOTSW3-TAUP	Taupe	USD 27.00	-
MDOTSW3-WHIT	White ***	USD 27.00	-
MDOTSW3-WALN	Walnut	USD 39.00	-

Pattern No.	Color	Contract Price	Lead Time
Extras			
MDOTSWC	Screw for Dots Wood and Ceramic	USD 2.00	-



Ø 9 cm / 3.5"

Shipper Colli 1
Gross Weight (kg) 0.123
Net Weight (kg) 0.08
Warranty Period 5 years

Pattern No.	Color	Contract Price	Lead Time
Ready-To-Ship US Warehouse			
MDOTSW4-ASH	Ash	USD 32.00	-
MDOTSW4-BLCK	Black	USD 32.00	-
MDOTSW4-BRGR	Brown Green	USD 32.00	-
MDOTSW4-BURG	Burgundy	USD 32.00	-
MDOTSW4-BORG	Burnt Orange	USD 32.00	-
MDOTSW4-DKGN	Dark Green	USD 32.00	-
MDOTSW4-DKGY	Dark Grey	USD 32.00	-
MDOTSW4-DGRN	Dusty Green	USD 32.00	-
MDOTSW4-GREY	Grey	USD 32.00	-
MDOTSW4-LTBU	Light Blue	USD 32.00	-
MDOTSW4-MBLU	Midnight Blue	USD 32.00	-
MDOTSW4-OAK	Oak	USD 32.00	-
MDOTSW4-OWHT	Off-White	USD 32.00	-
MDOTSW4-PABU	Pale Blue	USD 32.00	-
MDOTSW4-PETR	Petroleum ***	USD 32.00	-
MDOTSW4-SAGN	Sage Green	USD 32.00	-
MDOTSW4-STDB	Stained Dark Brown	USD 32.00	-
MDOTSW4-TAUP	Taupe	USD 32.00	-
MDOTSW4-WHIT	White ***	USD 32.00	-

Extras

MDOTSWC	Screw for Dots Wood and Ceramic	USD 2.00	-
---------	---------------------------------	----------	---



Ø 13 cm / 5"

Shipper Colli 1
Gross Weight (kg) 0.3
Net Weight (kg) 0.25
Warranty Period 5 years

Pattern No.	Color	Contract Price	Lead Time
Ready-To-Ship US Warehouse			
MDOTSW5-ASH	Ash	USD 39.00	-
MDOTSW5-BLCK	Black	USD 39.00	-
MDOTSW5-BRGR	Brown Green	USD 39.00	-
MDOTSW5-BURG	Burgundy	USD 39.00	-
MDOTSW5-BORG	Burnt Orange	USD 39.00	-
MDOTSW5-DKGN	Dark Green	USD 39.00	-
MDOTSW5-DKGY	Dark Grey	USD 39.00	-
MDOTSW5-DGRN	Dusty Green	USD 39.00	-
MDOTSW5-GREY	Grey	USD 39.00	-
MDOTSW5-LTBU	Light Blue	USD 39.00	-
MDOTSW5-MBLU	Midnight Blue	USD 39.00	-
MDOTSW5-OAK	Oak	USD 39.00	-
MDOTSW5-OWHT	Off-White	USD 39.00	-
MDOTSW5-PABU	Pale Blue	USD 39.00	-
MDOTSW5-PETR	Petroleum	USD 39.00	-
MDOTSW5-SAGN	Sage Green	USD 39.00	-
MDOTSW5-STDB	Stained Dark Brown	USD 39.00	-
MDOTSW5-TAUP	Taupe	USD 39.00	-
MDOTSW5-WHIT	White ***	USD 39.00	-
MDOTSW5-WALN	Walnut	USD 68.00	-

Pattern No.	Color	Contract Price	Lead Time
Ready-To-Ship EU Warehouse			
MDOTSW5-BEGN	Beige-Green ***	USD 39.00	-
Extras			
MDOTSWC	Screw for Dots Wood and Ceramic	USD 2.00	-



Ø 17 cm / 6.75"

Shipper Colli 1
Gross Weight (kg) 0.5
Net Weight (kg) 0.4
Warranty Period 5 years

Pattern No.	Color	Contract Price	Lead Time
Ready-To-Ship US Warehouse			
MDOTSW7-ASH	Ash	USD 42.00	-
MDOTSW7-BLCK	Black	USD 42.00	-
MDOTSW7-BRGR	Brown Green	USD 42.00	-
MDOTSW7-BURG	Burgundy	USD 42.00	-
MDOTSW7-BORG	Burnt Orange	USD 42.00	-
MDOTSW7-DKGN	Dark Green	USD 42.00	-
MDOTSW7-DKGY	Dark Grey	USD 42.00	-
MDOTSW7-DGRN	Dusty Green	USD 42.00	-
MDOTSW7-GREY	Grey	USD 42.00	-
MDOTSW7-LTBU	Light Blue	USD 42.00	-
MDOTSW7-MBLU	Midnight Blue	USD 42.00	-
MDOTSW7-MSTD	Mustard ***	USD 42.00	-
MDOTSW7-OAK	Oak	USD 42.00	-
MDOTSW7-OWHT	Off-White	USD 42.00	-
MDOTSW7-PABU	Pale Blue	USD 42.00	-
MDOTSW7-PETR	Petroleum	USD 42.00	-
MDOTSW7-SAGN	Sage Green	USD 42.00	-
MDOTSW7-STDB	Stained Dark Brown	USD 42.00	-
MDOTSW7-TAUP	Taupe	USD 42.00	-
MDOTSW7-WHIT	White	USD 42.00	-
MDOTSW7-WALN	Walnut	USD 79.00	-

Pattern No.	Color	Contract Price	Lead Time
Extras			
MDOTSWC	Screw for Dots Wood and Ceramic	USD 2.00	-

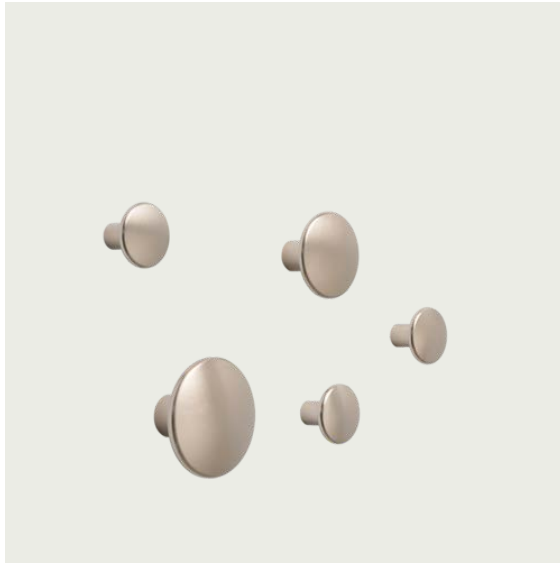

Shipper Colli 1
Gross Weight (kg) 0.485
Net Weight (kg) 0.15
Set of 5 Consists of 1x Ø 5 cm / 2", 1x Ø 3,9 cm / 1.5" and 3x Ø 2,7 cm / 1"
Warranty Period 5 years

Pattern No.	Color	Contract Price	Lead Time
Ready-To-Ship US Warehouse			
MDOTSMSET-ALUM	Aluminum	USD 167.00	-
MDOTSMSET-BLCK	Black	USD 167.00	-
MDOTSMSET-BRAS	Brass	USD 167.00	-
MDOTSMSET-PABU	Pale Blue ***	USD 167.00	-
MDOTSMSET-TAUP	Taupe	USD 167.00	-
MDOTSMSET-UMBR	Umber	USD 167.00	-
Ready-To-Ship EU Warehouse			
MDOTSMSET-DKGN	Dark Green	USD 167.00	-
MDOTSMSET-ROSE	Rose	USD 167.00	-
Extras			
MDOTSMSS	Screw for Dots Metal	USD 9.00	-

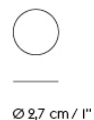
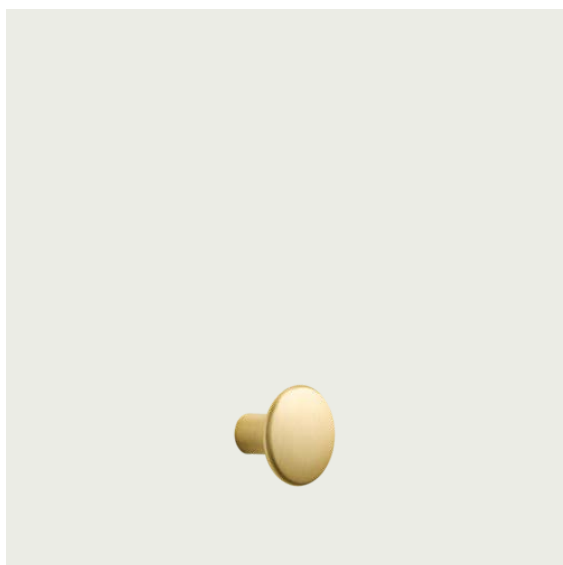

Shipper Colli 1
Gross Weight (kg) 0.11
Net Weight (kg) 0.02
Warranty Period 5 years

Pattern No.	Color	Contract Price	Lead Time
Ready-To-Ship US Warehouse			
MDOTSM1-ALUM	Aluminum	USD 29.00	-
MDOTSM1-BLCK	Black	USD 29.00	-
MDOTSM1-BRAS	Brass	USD 29.00	-
MDOTSM1-DKGN	Dark Green	USD 29.00	-
MDOTSM1-LTGN	Light Green	USD 29.00	-
MDOTSM1-LILC	Lilac	USD 29.00	-
MDOTSM1-PABU	Pale Blue	USD 29.00	-
MDOTSM1-ROSE	Rose	USD 29.00	-
MDOTSM1-TAUP	Taupe	USD 29.00	-
MDOTSM1-UMBR	Umber	USD 29.00	-
Extras			
MDOTSMSS	Screw for Dots Metal	USD 9.00	-

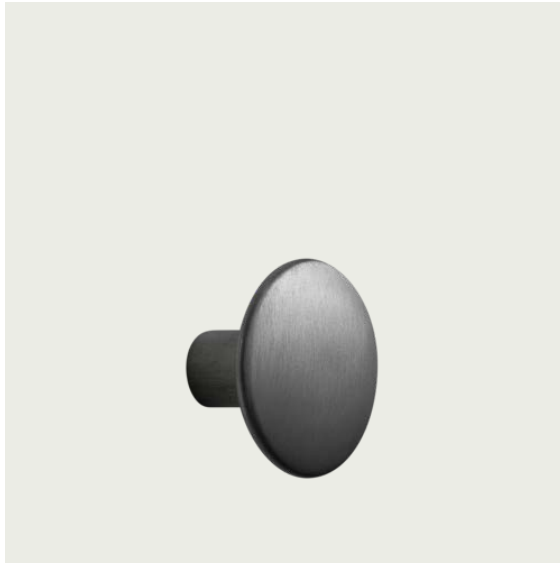

Ø 3,9 cm / 1.5"

Shipper Colli 1
 Gross Weight (kg) 0.14
 Net Weight (kg) 0.04
 Warranty Period 5 years

Pattern No.	Color	Contract Price	Lead Time
Ready-To-Ship US Warehouse			
MDOTSM15-ALUM	Aluminum	USD 40.00	-
MDOTSM15-BLCK	Black	USD 40.00	-
MDOTSM15-BRAS	Brass	USD 40.00	-
MDOTSM15-DKGN	Dark Green	USD 40.00	-
MDOTSM15-LTGN	Light Green	USD 40.00	-
MDOTSM15-LILC	Lilac	USD 40.00	-
MDOTSM15-PABU	Pale Blue	USD 40.00	-
MDOTSM15-ROSE	Rose	USD 40.00	-
MDOTSM15-TAUP	Taupe	USD 40.00	-
MDOTSM15-UMBR	Umber	USD 40.00	-
Extras			
MDOTSMSS	Screw for Dots Metal	USD 9.00	-

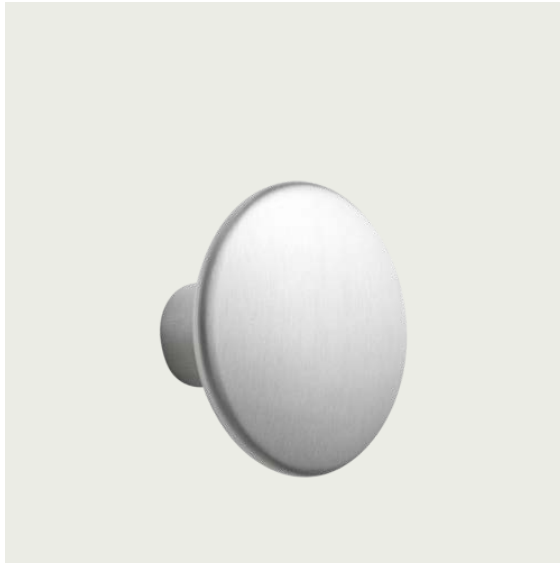

Ø 5 cm / 2"

Shipper Colli 1
Gross Weight (kg) 0.24
Net Weight (kg) 0.07
Warranty Period 5 years

Pattern No.	Color	Contract Price	Lead Time
Ready-To-Ship US Warehouse			
MDOTSM2-ALUM	Aluminum	USD 52.00	-
MDOTSM2-BLCK	Black	USD 52.00	-
MDOTSM2-BRAS	Brass	USD 52.00	-
MDOTSM2-DKGN	Dark Green ***	USD 52.00	-
MDOTSM2-LTGN	Light Green	USD 52.00	-
MDOTSM2-LILC	Lilac	USD 52.00	-
MDOTSM2-PABU	Pale Blue ***	USD 52.00	-
MDOTSM2-ROSE	Rose	USD 52.00	-
MDOTSM2-TAUP	Taupe	USD 52.00	-
MDOTSM2-UMBR	Umber	USD 52.00	-
Extras			
MDOTSMSS	Screw for Dots Metal	USD 9.00	-

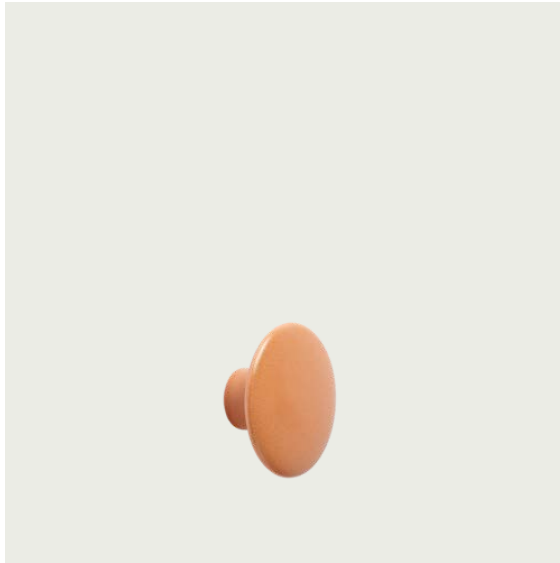

Ø 9 cm / 3.5"

Shipper Colli 1
 Gross Weight (kg) 0.2
 Net Weight (kg) 0.11
 Warranty Period 5 years

Pattern No.	Color	Contract Price	Lead Time
Ready-To-Ship US Warehouse			
MDOTSC4-BORG	Burnt Orange	USD 44.00	-
MDOTSC4-LTBU	Light Blue	USD 44.00	-
MDOTSC4-ROSE	Rose ***	USD 44.00	-
Extras			
MDOTSWC	Screw for Dots Wood and Ceramic	USD 2.00	-



Ø 13 cm / 5"

Shipper Colli 1
 Gross Weight (kg) 0.3
 Net Weight (kg) 0.225
 Warranty Period 5 years

Pattern No.	Color	Contract Price	Lead Time
Ready-To-Ship US Warehouse			
MDOTSC5-BORG	Burnt Orange	USD 58.00	-
MDOTSC5-LTBU	Light Blue	USD 58.00	-
MDOTSC5-ROSE	Rose ***	USD 58.00	-
Extras			
MDOTSWC	Screw for Dots Wood and Ceramic	USD 2.00	-

FOLDED SHELVES

"Inspired by the shadow-play of layers, Folded is based on a seemingly simple bending technique of a single sheet of metal to create pockets which hold and separate your items. Featuring a subtle bolt and hooks for hanging objects, it is a versatile wall mount that can be used in both a practical and a decorative manner—suitable for organizing anything from mail to books, perfumes or spices, or just displaying your favorite belongings, in the hallway, bathroom, bedroom or kitchen."

— Johan Van Hengel



Designed by	Johan Van Hengel
Environment	Indoor
Country of Production	China
Description	Imitating the look of folded paper yet shaped in metal, the Folded Shelves have a contemporary, functional character. The shelves come with two hooks and two bolts for mounting on the wall. The Folded Shelves are a modern and friendly way to add storage to any home or professional space.
Material	Laser cut from metal sheets, these shelves go through a folding process. They are then lacquered with an acrylic powder coating.
Cleaning & Care	Remove dust from shelves with a soft cloth or remove abrasive dust particles. When necessary clean with moist cloth.

FOLDED SHELVES / 29,5 X 40 CM / 11.5 X 15.75"

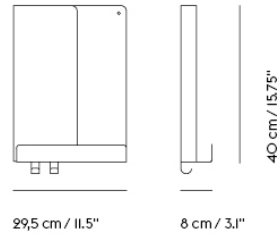

Shipper Colli 1
Gross Weight (kg) 3.5
Net Weight (kg) 2.8
Warranty Period 5 years

Pattern No.	Color	Contract Price	Lead Time
Ready-To-Ship US Warehouse			
MFLDSHXS-BLCK	Black	USD 177.00	-
MFLDSHXS-BUGY	Blue-Grey	USD 177.00	-
MFLDSHXS-BORG	Burnt Orange	USD 177.00	-
MFLDSHXS-DPRD	Deep Red	USD 177.00	-
MFLDSHXS-GREY	Grey	USD 177.00	-
MFLDSHXS-OLIV	Olive	USD 177.00	-

FOLDED SHELVES / 51 X 22 CM / 20 X 8.75"

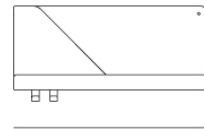

51 cm / 20"



6,9 cm / 2.75"

22 cm / 8.75"

Shipper Colli	1
Gross Weight (kg)	2.9
Net Weight (kg)	2.35
Warranty Period	5 years

Pattern No.	Color	Contract Price	Lead Time
Ready-To-Ship US Warehouse			
MFLDSHSM-BLCK	Black	USD 177.00	-
MFLDSHSM-BUGY	Blue-Grey	USD 177.00	-
MFLDSHSM-BORG	Burnt Orange	USD 177.00	-
MFLDSHSM-DPRD	Deep Red	USD 177.00	-
MFLDSHSM-GREY	Grey	USD 177.00	-
MFLDSHSM-OLIV	Olive	USD 177.00	-

FOLDED SHELVES / 63 X 16,5 CM / 24.75 X 6.5"



63 cm / 24.75"



16,5 cm / 6.5"

12,4 cm / 4.75"

Shipper Colli	1
Gross Weight (kg)	3.4
Net Weight (kg)	2.85
Warranty Period	5 years

Pattern No.	Color	Contract Price	Lead Time
Ready-To-Ship US Warehouse			
MFLDSHMD-BLCK	Black	USD 251.00	-
MFLDSHMD-BUGY	Blue-Grey	USD 251.00	-
MFLDSHMD-BORG	Burnt Orange	USD 251.00	-
MFLDSHMD-DPRD	Deep Red	USD 251.00	-
MFLDSHMD-GREY	Grey	USD 251.00	-
MFLDSHMD-OLIV	Olive	USD 251.00	-

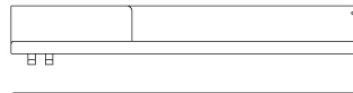

96 cm / 37.75"



13 cm / 5"

Shipper Colli 1
 Gross Weight (kg) 4.2
 Net Weight (kg) 3.55
 Warranty Period 5 years

Pattern No.	Color	Contract Price	Lead Time
Ready-To-Ship US Warehouse			
MFLDShLG-BLCK	Black	USD 324.00	-
MFLDShLG-BUGY	Blue-Grey	USD 324.00	-
MFLDShLG-BORG	Burnt Orange	USD 324.00	-
MFLDShLG-DPRD	Deep Red	USD 324.00	-
MFLDShLG-GREY	Grey	USD 324.00	-
MFLDShLG-OLIV	Olive	USD 324.00	-

**FOLDED SHELVES / PLATFORM / 62 X 5,4
CM / 24.4 X 2"**

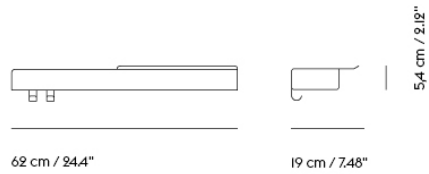

Shipper Colli	1
Gross Weight (kg)	3.1
Net Weight (kg)	2.3
Warranty Period	5 years

Pattern No.	Color	Contract Price	Lead Time
Ready-To-Ship US Warehouse			
MFLDSHPLT-BLCK	Black	USD 324.00	-
MFLDSHPLT-BUGY	Blue-Grey	USD 324.00	-
MFLDSHPLT-BORG	Burnt Orange	USD 324.00	-
MFLDSHPLT-DPRD	Deep Red	USD 324.00	-
MFLDSHPLT-GREY	Grey	USD 324.00	-
MFLDSHPLT-OLIV	Olive	USD 324.00	-

FRAMED MIRROR

"We wanted to create a mirror that was more than merely a reflective surface. Framed is a new perspective to the classic framed mirror; it is a decorative design piece that leads your thoughts to installation art. It adds not only the functionality of a mirror to your home, but with its depth, organic shape and tone-in-tone color, it is almost perceived as an art object on the wall. The Framed Mirror can hang beautifully on your walls alone or combined with other sizes and colors."

— Anderssen & Voll



Designed by	Anderssen & Voll
Environment	Indoor
Country of Production	Vietnam
Description	Made from powder coated steel frames with colored mirror glass, the Framed Mirror is a gently artistic interpretation of the archetypal mirror. Though still functioning as reflecting glass, the colors, shapes and its ability to be arranged in groups gives the mirror a distinct character.
Material	A steel plate is worked through three rounds to shape the mirror's frame. The surface is then powder lacquered using a highly durable acrylic lacquer. Lastly, mirror glass is gently installed, to create the little gap between the mirror's frame and mirror glass.
Cleaning & Care	Clean mirror glass using a mild glass spray and a soft dry cloth.
Additional Information	The mirrors are not suited for use in bathrooms and other wet rooms. Mirrors can be mounted both vertically and horizontally.

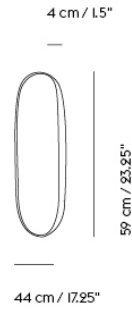
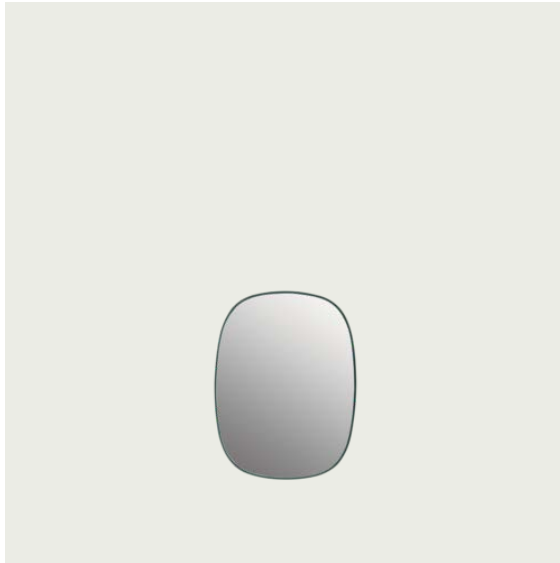

Shipper Colli 1
Gross Weight (kg) 8.5
Net Weight (kg) 5.5
Warranty Period 5 years

Pattern No.	Color	Contract Price	Lead Time
Ready-To-Ship US Warehouse			
MFRMMIRSM-ROSECL	Rose/Clear	USD 450.00	-
MFRMMIRSM-DKGNCL	Dark Green/Clear	USD 450.00	-
MFRMMIRSM-GREYCL	Grey/Clear	USD 450.00	-
MFRMMIRSM-ROSERE	Rose/Rose	USD 450.00	-
MFRMMIRSM-TAUPCL	Taupe/Clear	USD 450.00	-
MFRMMIRSM-TAUPTP	Taupe/Taupe	USD 450.00	-

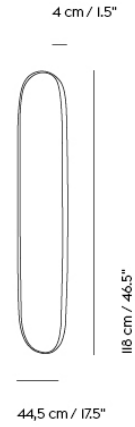
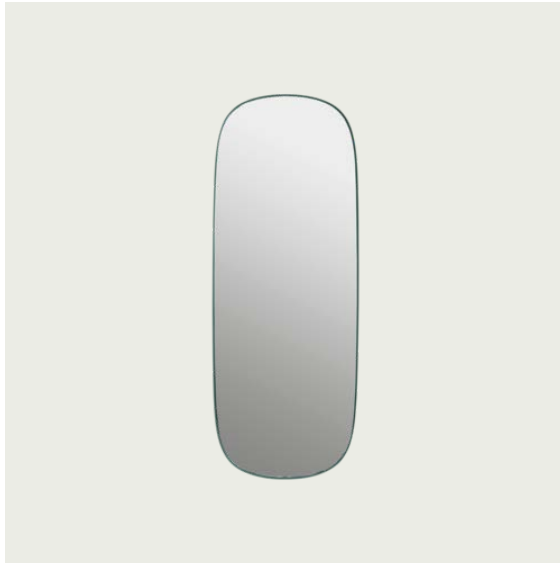

Shipper Colli 1
Gross Weight (kg) 16.2
Net Weight (kg) 11.8
Warranty Period 5 years

Pattern No.	Color	Contract Price	Lead Time
Ready-To-Ship US Warehouse			
MFRMMIRLG-ROSECL	Rose/Clear	USD 849.00	-
MFRMMIRLG-DKGNCL	Dark Green/Clear	USD 849.00	-
MFRMMIRLG-GREYCL	Grey/Clear	USD 849.00	-
MFRMMIRLG-ROSERE	Rose/Rose	USD 849.00	-
MFRMMIRLG-TAUPCL	Taupe/Clear	USD 849.00	-
MFRMMIRLG-TAUPTP	Taupe/Taupe	USD 849.00	-

GROOVE TRIVET

"Trivets are normally stowed away when not in use, yet I wanted to create a beautiful object, which can add to the atmosphere and bear being displayed. The linear grooves in the marble give the trivets a graphic expression and serves as a nice contrast to the natural structures and patterns in the marble. Leave the Groove Trivets on the table even when not in use and let them add character to your interior."

— Hallgeir Homstvedt



Designed by	Hallgeir Homstvedt
Environment	Indoor
Country of Production	China
Description	When used as a trivet for hot or cold items, the carved trenches of the Groove Trivet allows air to flow through, leaving the table underneath it undamaged. Though a functional object, the Groove Trivet can also be used as a decorative piece, whether it be as a tray, stand, or on its own, adding texture to any room. Visual variations of the marble render each piece entirely unique; the trivet is available in two sizes and three colors.
Material	Raw solid marble is cut, shaped and the surface is oiled.
Cleaning & Care	Hand wash only.

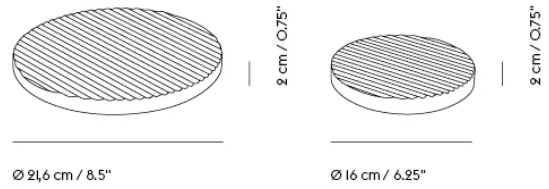

Shipper Colli | 1
Gross Weight (kg) | 1.45
Net Weight (kg) | 1.3
Warranty Period | 5 years

Pattern No.	Color	Contract Price	Lead Time
Ready-To-Ship EU Warehouse			
MGRVT6-GREN	Green - Ø 16 cm / 6.25"	USD 72.00	-
MGRVT6-GREY	Grey - Ø 16 cm / 6.25"	USD 72.00	-
MGRVT9-GREN	Green - Ø 21,6 cm / 8.5"	USD 100.00	-
MGRVT9-GREY	Grey - Ø 21,6 cm / 8.5"	USD 100.00	-

KINK VASE

"My starting point for the Kink Vase was an exploration of how new forms could be created through the digital manipulation of simple shapes. The design combines this appreciation of modern technology with traditional ceramic craft, resulting in a piece that is both contemporary and sculptural. The graphic and playful appearance of the Kink Vase—combined with its double opening, which suggests a new way to arrange flowers infuses its surroundings with joy."

— Earnest Studio



Designed by	Earnest Studio
Environment	Indoor
Country of Production	China
Description	The Kink Vase brings a contemporary form to the archetypal flower vase through a combination of traditional craftsmanship and playful design language. With its double opening, the Kink Vase adds a sculptural sentiment to the room, even when not in use. The design is made in porcelain that has been glazed on the inside for a refined touch.
Material	Pigmented porcelain. Glazed on the inside and raw on the outside. Small variations in the surface and color of the object are a natural and unique trait of the material.
Cleaning & Care	Hand wash only with water or soapy water. The outside of the Kink Vase is raw and should not be cleaned using any object or cloth that can scratch its surface. Only use a wash cloth. Do not use brushes of any kind. Note that vigorous cleaning can damage the finish of the vase over time. Never use chlorine bleach products as it will damage the vase.

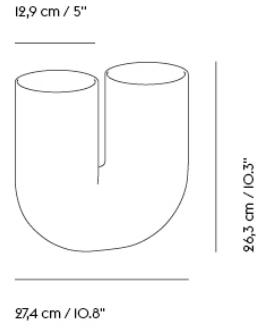

Shipper Colli 1
Gross Weight (kg) 2.4
Net Weight (kg) 1.946
Warranty Period 5 years

Pattern No.	Color	Contract Price	Lead Time
Ready-To-Ship US Warehouse			
MKINVS-DLIL	Dusty Lilac	USD 383.00	-
MKINVS-LTBU	Light Blue	USD 383.00	-
MKINVS-SAND	Sand	USD 383.00	-

LAYER CUSHION

"The idea for the Layer Cushion was to create a soft feel, joined by an understatedly graphic expression of overlapping layers. Knitted in a tactile structure of baby llama wool, the Layer Cushion brings the concepts of comfort and natural materials into everyday life."

— Aiayu



Designed by	Aiayu
Environment	Indoor
Country of Production	Bolivia
Description	The Layer Cushion has a soft feel, joined by a graphic expression of overlapping layers. Knitted in a tactile structure of baby llama wool, the Layer Cushion—designed by Copenhagen-based designers Aiayu—brings the concepts of comfort and natural materials into everyday life.
Material	The pillow case is made from 100% baby llama wool, the inner sham is 100% cotton and the filling consists of 50% feather, 50% polyfiber.
Cleaning & Care	This product is made from 100% baby llama wool—a self-cleaning fiber that requires less washing than other materials. Simply air your product at first. If the need to wash it arises, hand wash is recommended at 30 degrees C using high-quality soap. Soak the product in water for 10 - 15 minutes before rinsing it in 30 degrees C water. Avoid twisting or pressing the water out. Let the product dry flat.

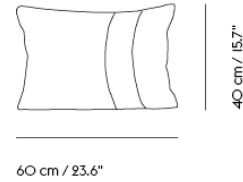

Shipper Colli |
 Gross Weight (kg) | 0.65
 Net Weight (kg) | 0.6
 Warranty Period | 5 years

Pattern No.	Color	Contract Price	Lead Time
Ready-To-Ship US Warehouse			
MLAYCUS1624-DKGN	Dark Green ***	USD 146.00	-
MLAYCUS1624-DKGY	Dark Grey ***	USD 146.00	-
MLAYCUS1624-SDGY	Sand-Grey ***	USD 146.00	-
Ready-To-Ship EU Warehouse			
MLAYCUS1624-MBLU	Midnight Blue ***	USD 146.00	-

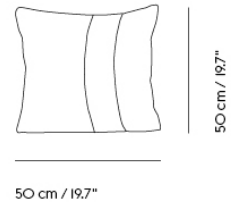

Shipper Colli 1
 Gross Weight (kg) 0.65
 Net Weight (kg) 0.6
 Warranty Period 5 years

Pattern No.	Color	Contract Price	Lead Time
Ready-To-Ship US Warehouse			
MLAYCUS2020-DKGY	Dark Grey ***	USD 146.00	-
MLAYCUS2020-DROS	Dusty Rose ***	USD 146.00	-
MLAYCUS2020-MBLU	Midnight Blue ***	USD 146.00	-
MLAYCUS2020-SDGY	Sand-Grey ***	USD 146.00	-
Ready-To-Ship EU Warehouse			
MLAYCUS2020-DKGN	Dark Green ***	USD 146.00	-

MERE BOWL

"Mere Bowl was inspired by a small porcelain piece Salla made on the pottery wheel in our studio — the contrast between its conical round shape and the strict line of its bottom inspired us to continue experimenting with it. Initially prototyping with paper, we created bowl-like surfaces through folding, later moving from bendable materials to the rigidity of plaster. We wanted it to be as much a humble and utilitarian item as an elegant standalone sculptural form, casting beautiful shadows when empty."

— Studio Kaksikko



Designed by Studio Kaksikko

Environment Indoor

Country of Production Portugal

Description The Mere Bowl is a sculptural centerpiece, one that looks beautiful in a tablespace or space whether it is in use or not. Its characteristic shape is simple yet ingenious, as a line down its middle folds out to the sides forming a bowl. Elevated by a discrete foot, it looks as if floating. Manufactured in tactile ceramic stoneware, it has been coated in a high-gloss glaze that enhances the shadows that form along Mere Bowl's fold. This surface treatment makes the bowl food safe.

Material Made in ceramic stoneware with a high gloss glaze inside & out. The production process makes each bowl unique with small deviations in color, thickness and surface.

Cleaning & Care Handwash only with water or soapy water.

TESTS & CERTIFICATIONS

European Parliament and Council Regulation (EC) 1935/2004/EC

Commission Regulation (EC) No 2023/2006 of 22 December 2006 on good manufacturing practice for materials and articles intended to come into contact with food (GMP)

US Food and Drug Administration (FDA) Title 21 Code of Federal Regulations (CFR, 2011 Edition) as applicable

MERE BOWL / 51,5 X 21,5 CM / 20.5 X 8.5"

586

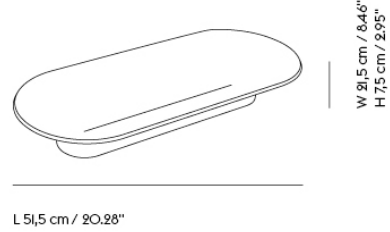

Shipper Colli 1
Gross Weight (kg) 3
Net Weight (kg) 2.3
Warranty Period 5 years

Pattern No.	Color	Contract Price	Lead Time
Ready-To-Ship US Warehouse			
MMERBWL2109-BRGR	Brown Green	USD 226.00	-
MMERBWL2109-LTGN	Light Green	USD 226.00	-
MMERBWL2109-OWHT	Off-White	USD 226.00	-

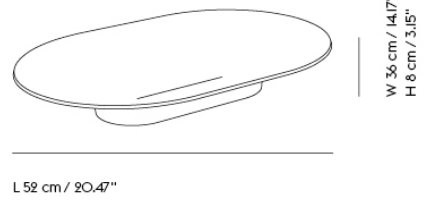

Shipper Colli 1
Gross Weight (kg) 4.2
Net Weight (kg) 3.1
Warranty Period 5 years

Pattern No.	Color	Contract Price	Lead Time
Ready-To-Ship US Warehouse			
MMERBWL2115-BRGR	Brown Green	USD 278.00	-
MMERBWL2115-LTGN	Light Green	USD 278.00	-
MMERBWL2115-OWHT	Off-White	USD 278.00	-

MINGLE CUSHION

"My idea was to create a series of cushions based on the simple intertwinement of color and textile. The process was equally straightforward and complex. It turned out to be an exciting journey through the world of color and texture and in the end we found a combination where the two mingle well and complement each other. The Mingle family, being a very inclusive group, also love to mingle on your sofa."

— Thomas Bentzen



Designed by	Thomas Bentzen
Environment	Indoor
Contry of Production	Turkey
Description	Mingle Cushion is a piece where contrasts harmonize in a compelling mingling of color and materials. Use it front or back, depending on which expression you would like to play with — textured or smooth. Mingle Cushion is available in two sizes and 8 color variants ideal to mix and match.
Material	Cushion cover: Textiles Ecriture/Hero from Kvadrat Inner sham: 55% polyester, 45% cotton Fill: 100% polyester
Cleaning & Care	Cushion cover: professional dry clean only. Inner Cushion: 30 degrees C, no iron, no tumble dry.

MINGLE CUSHION / 45 X 45 CM / 17.7 X 17.7"

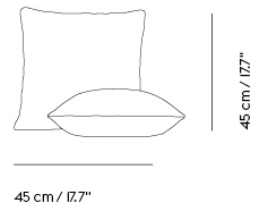

Shipper Colli 1
 Gross Weight (kg) 0.541
 Net Weight (kg) 0.534
 Warranty Period 5 years

Pattern No.	Color	Contract Price	Lead Time
Ready-To-Ship US Warehouse			
MMNGCUS1818-CPBNLTBU	Copper Brown / Light Blue	USD 163.00	-
MMNGCUS1818-LTBUMINT	Light Blue / Mint	USD 163.00	-
MMNGCUS1818-LIGN	Light Green	USD 163.00	-
MMNGCUS1818-LIYW	Light Yellow	USD 163.00	-
MMNGCUS1818-MBLU	Midnight Blue	USD 163.00	-
MMNGCUS1818-PETRROSE	Rose / Petroleum	USD 163.00	-
MMNGCUS1818-SANDLILC	Sand / Lilac	USD 163.00	-
MMNGCUS1818-TAUP	Taupe	USD 163.00	-

MINGLE CUSHION / 35 X 55 CM / 13.7 X 21.7"

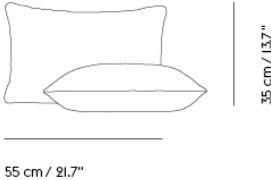

Shipper Colli | 1
Gross Weight (kg) 0.539
Net Weight (kg) 0.532
Warranty Period 5 years

Pattern No.	Color	Contract Price	Lead Time
Ready-To-Ship US Warehouse			
MMNGCUS1422-CPBNLTBU	Copper Brown / Light Blue	USD 163.00	-
MMNGCUS1422-LTBUMINT	Light Blue / Mint	USD 163.00	-
MMNGCUS1422-LIGN	Light Green	USD 163.00	-
MMNGCUS1422-LIYW	Light Yellow	USD 163.00	-
MMNGCUS1422-MBLU	Midnight Blue	USD 163.00	-
MMNGCUS1422-PETROSE	Rose / Petroleum	USD 163.00	-
MMNGCUS1422-SANDLILC	Sand / Lilac	USD 163.00	-
MMNGCUS1422-TAUP	Taupe	USD 163.00	-

PEBBLE RUG

"Pebble Rug is inspired by the sensuous feeling of a pebbled beach with its diverse and tactile surface, inviting you to take off your shoes and walk across it barefooted. With a handwoven structure that references fashion textiles, the Pebble Rug plays with the contrasting materials of its soft, woolen loops, sitting atop a sturdy canvas base in cooling jute yarn. Pebble Rug brings a new perspective to any space through its woolen loops, popping up from the ground like sprouts in a bed of moss, joined by the distinct woven texture of its surface."

— Margrethe Odgaard



Designed by	Margrethe Odgaard
Environment	Indoor
Country of Production	India
Description	Pebble Rug has a diverse and tactile surface, inspired by the sensuous feeling of walking across a pebbled beach. Its handwoven structure contrasts the feel of its soft, woolen loops with a canvas base in a sturdier wool quality. Pebble Rug has a distinct and modern woven texture for any home, hospitality setting, lobby, hotel space or co-working area.
Material	<p>Pebble Rug is hand-woven from 100% New Zealand wool. Backing in 100% cotton, pasted with synthetic latex which ensures that the rug lays smoothly on the floor.</p> <p>Pebble Rug is made from wool. The color of wool may vary due to the wool's natural base color. This means that the Pebble Rug can have slight color variations from one rug to the other as a result of the inherent characteristics of wool, enhancing the natural sentiment of the Pebble Rug.</p> <p>Please note that all sizes of the Pebble Rug have a sizing toleration of + / - 2%, meaning that the dimensions of the rug can differ by a maximum of 2%.</p>
Cleaning & Care	<p>For general care of the rug, we recommend gentle vacuum cleaning on a regular basis. Please use the vacuum cleaner without brush head to avoid tearing of the pebbles. For cleaning of stains or spots, we recommend professional dry cleaning. Avoid cleaning with water, as this will damage the product.</p>

TESTS & CERTIFICATIONS

US Flammability I6 CFR part I630/I631

VOC CDPH 01350 and VOC Bifma X7.1

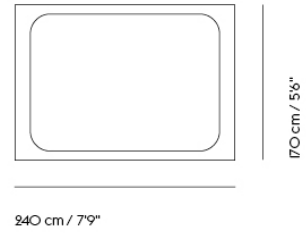

Shipper Colli 1
Gross Weight (kg) 18.4
Net Weight (kg) 17.8
Warranty Period 5 years

Pattern No.	Color	Contract Price	Lead Time
Ready-To-Ship US Warehouse			
MPEBRG6693-BRGR	Brown Green	USD 1,675.00	-
MPEBRG6693-DKGY	Dark Grey	USD 1,675.00	-
MPEBRG6693-PABU	Pale Blue	USD 1,675.00	-

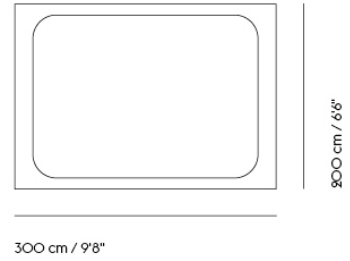

Shipper Colli 1
Gross Weight (kg) 24.3
Net Weight (kg) 22.1
Warranty Period 5 years

Pattern No.	Color	Contract Price	Lead Time
Ready-To-Ship US Warehouse			
MPEBRG78116-BRGR	Brown Green	USD 2,620.00	-
MPEBRG78116-PABU	Pale Blue	USD 2,620.00	-

PLATFORM TRAY

"With the Platform Tray, we wanted to create a design that had duality at its heart, incorporating the ideas of Scandinavian design by involving functionality across different levels: It can sit on a table surface to hold your favorite objects, raising them up on a platform, or it can be picked up and used as a tray for moving elements from one room to the other. This collision of functions—a small table and a small tray—creates room for dynamic contexts as well as still life settings. It is also repeated in the tray's materials: Molded plastic is shared with veneered wood, allowing for the Platform Tray to complement multiple atmospheres."

— Sam Hecht & Kim Colin



Designed by	Sam Hecht & Kim Colin
Environment	Indoor
Country of Production	China
Description	The Platform Tray fuses the function of Scandinavian design with Japanese artisanry to form a stackable tray with a multitude of uses.
Material	Tray in ABS, insert in laminated oak veneer.
Cleaning & Care	The tray, without the oak veneer insert, is dishwasher proof. Clean oak veneer insert with a soft damp cloth and remove excess water with a dry cloth.

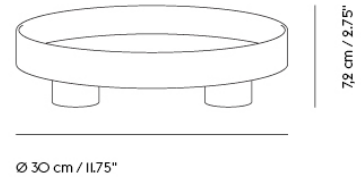
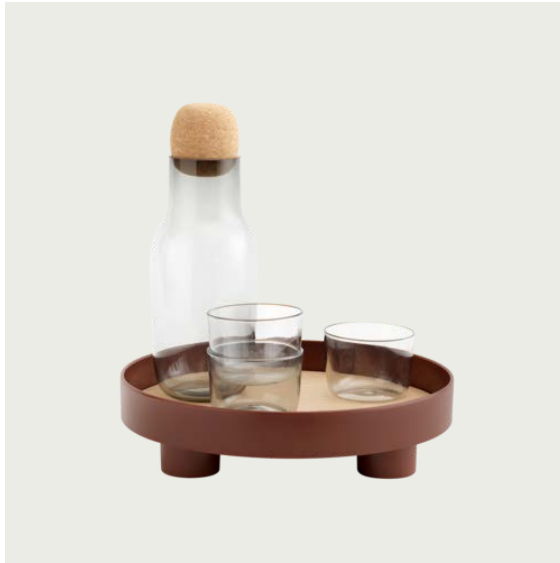

Shipper Colli 1
 Gross Weight (kg) 0.9
 Net Weight (kg) 0.65
 Warranty Period 5 years

Pattern No.	Color	Contract Price	Lead Time
Ready-To-Ship US Warehouse			
MPLTTY-BUGY	Blue Grey	USD 114.00	-
MPLTTY-DKGN	Dark Green	USD 114.00	-
MPLTTY-DKRD	Dark Red	USD 114.00	-
MPLTTY-GREY	Grey	USD 114.00	-

PLY RUG

"Ply Rug is a simple and elegant design that emphasizes the inherent craft of traditional hand weaving. With its broken twill structure that enhances the vibrant and almost three-dimensional pattern of the design, Ply Rug is at once modern and timeless. Made from 100% New Zealand wool, Ply Rug comes with tassel finishes that subtly hint towards traditional craftsmanship, echoing the new perspectives on Scandinavian design."

— Margrethe Odgaard



Designed by	Margrethe Odgaard
Environment	Indoor
Country of Production	India
Description	With its graphic expression and subtle details, the Ply Rug gently hints towards the weaving traditions of the past, communicated through its broken twill weave structure and tassel finishes. Made in 100% wool, the Ply Rug is available in seven colors across seven sizes.
Material	Made from 100% New Zealand wool. A rug pad underneath is recommended to keep the rug in place. Please note that the color of Ply Rug may vary due to the wool's natural base color. Please note that all sizes of the Ply rug have a sizing toleration of + / - 2%, meaning that the dimensions of the rug can differ by a maximum of 2%.
Cleaning & Care	For regular cleaning, vacuum the rugs. Clean stains instantly with sparkling water. The rugs should be turned every 6 months for maintenance purposes.
Spare Parts	Rug pad.

TESTS & CERTIFICATIONS

US Flammability I6 CFR part I630/I631

VOC CDPH 01350 and VOC Bifma X7.1

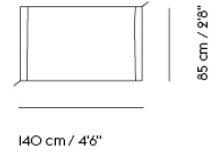

Shipper Colli 1
Gross Weight (kg) 3.4
Net Weight (kg) 2.9
Warranty Period 5 years

Pattern No.	Color	Contract Price	Lead Time
Ready-To-Ship US Warehouse			
MPLYRG3254-BLWH	Black/White	USD 356.00	-
MPLYRG3254-BORG	Burnt Orange	USD 356.00	-
MPLYRG3254-DKGY	Dark Grey ***	USD 356.00	-
MPLYRG3254-GREY	Grey	USD 356.00	-
MPLYRG3254-LROS	Light Rose	USD 356.00	-
MPLYRG3254-MBLU	Midnight Blue ***	USD 356.00	-
MPLYRG3254-OWHT	Off-White	USD 356.00	-
MPLYRG3254-ROSE	Rose ***	USD 356.00	-
MPLYRG3254-YELW	Yellow	USD 356.00	-
Extras			
MPLYPA3254	Rug Pad - 75 x 130 cm / 2'5 x 4'3"	USD 44.00	-

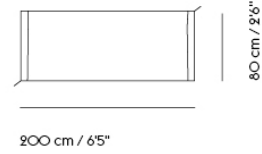

Shipper Colli 1
Gross Weight (kg) 3.8
Net Weight (kg) 2.9
Warranty Period 5 years

Pattern No.	Color	Contract Price	Lead Time
Ready-To-Ship US Warehouse			
MPLYRG3077-BLWH	Black/White	USD 450.00	-
MPLYRG3077-BORG	Burnt Orange	USD 450.00	-
MPLYRG3077-DKGY	Dark Grey ***	USD 450.00	-
MPLYRG3077-GREY	Grey	USD 450.00	-
MPLYRG3077-LROS	Light Rose	USD 450.00	-
MPLYRG3077-MBLU	Midnight Blue ***	USD 450.00	-
MPLYRG3077-OWHT	Off-White	USD 450.00	-
MPLYRG3077-ROSE	Rose ***	USD 450.00	-
MPLYRG3077-YELW	Yellow	USD 450.00	-
Extras			
MPLYPA3077	Rug Pad - 70 x 190 cm / 2'3 x 6'2"	USD 68.00	-

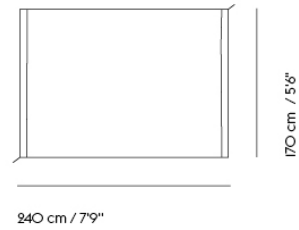

Shipper Colli 1
Gross Weight (kg) 10.5
Net Weight (kg) 8.6
Warranty Period 5 years

Pattern No.	Color	Contract Price	Lead Time
Ready-To-Ship US Warehouse			
MPLYRG6681-BLWH	Black/White	USD 1,028.00	-
MPLYRG6681-BORG	Burnt Orange	USD 1,028.00	-
MPLYRG6681-DKGY	Dark Grey ***	USD 1,028.00	-
MPLYRG6681-GREY	Grey	USD 1,028.00	-
MPLYRG6681-LROS	Light Rose	USD 1,028.00	-
MPLYRG6681-MBLU	Midnight Blue	USD 1,028.00	-
MPLYRG6681-OWHT	Off-White	USD 1,028.00	-
MPLYRG6681-ROSE	Rose	USD 1,028.00	-
MPLYRG6681-YELW	Yellow	USD 1,028.00	-
Extras			
MPLYPA6681	Rug Pad - 160 x 230 cm / 5'2 x 7'5"	USD 89.00	-

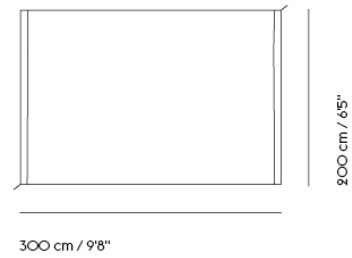

Shipper Colli 1
Gross Weight (kg) 14.7
Net Weight (kg) 12.8
Warranty Period 5 years

Pattern No.	Color	Contract Price	Lead Time
Ready-To-Ship US Warehouse			
MPLYRG78116-BLWH	Black/White	USD 1,626.00	-
MPLYRG78116-BORG	Burnt Orange	USD 1,626.00	-
MPLYRG78116-DKGY	Dark Grey	USD 1,626.00	-
MPLYRG78116-GREY	Grey	USD 1,626.00	-
MPLYRG78116-LROS	Light Rose	USD 1,626.00	-
MPLYRG78116-MBLU	Midnight Blue ***	USD 1,626.00	-
MPLYRG78116-OWHT	Off-White	USD 1,626.00	-
MPLYRG78116-ROSE	Rose	USD 1,626.00	-
MPLYRG78116-YELW	Yellow	USD 1,626.00	-
Extras			
MPLYPA78116	Rug Pad - 190 x 290 cm / 6'2 x 9'5"	USD 110.00	-



Shipper Colli 1
Gross Weight (kg) 24.3
Net Weight (kg) 20.6
Warranty Period 5 years

Pattern No.	Color	Contract Price	Lead Time
Ready-To-Ship US Warehouse			
MPLYRG104140-BLWH	Black/White	USD 2,571.00	-
MPLYRG104140-DKGY	Dark Grey ***	USD 2,571.00	-
MPLYRG104140-GREY	Grey	USD 2,571.00	-
MPLYRG104140-LROS	Light Rose	USD 2,571.00	-
MPLYRG104140-MBLU	Midnight Blue ***	USD 2,571.00	-
MPLYRG104140-OWHT	Off-White	USD 2,571.00	-
MPLYRG104140-ROSE	Rose ***	USD 2,571.00	-
MPLYRG104140-YELW	Yellow	USD 2,571.00	-
Extras			
MPLYPA104140	Rug Pad - 260 x 350 cm / 8'5 x 11'5"	USD 226.00	-

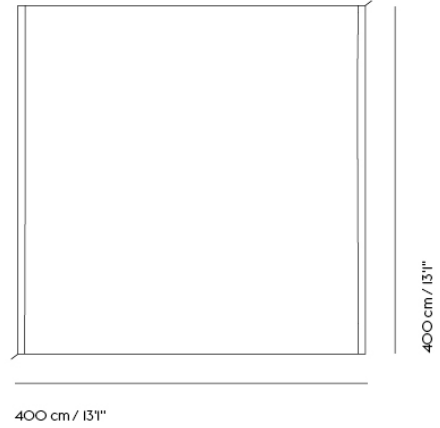

Shipper Colli 1
Gross Weight (kg) 42.8
Net Weight (kg) 34.1
Warranty Period 5 years

Pattern No.	Color	Contract Price	Lead Time
Ready-To-Ship US Warehouse			
MPLYRG157157-MBLU	Midnight Blue ***	USD 4,090.00	-
MPLYRG157157-OWHT	Off-White ***	USD 4,090.00	-
MPLYRG157157-ROSE	Rose ***	USD 4,090.00	-
Extras			
MPLYPA157157	Rug Pad - 380 x 380 cm / 12'5 x 12'5" ***	USD 345.00	-

RAISE CARAFE & GLASS

"It was focal to us that the Raise Carafe & Glass brought a subtle yet characterful ethos to the traditional craft of mouth-blown glass, adding a lightly elegant sentiment in daily life. After working through different ideas and sketches, we were inspired by the generic shapes of bottles and glasses in modernist still life paintings and felt that their silhouettes struck the balance of being at once timeless yet bursting with character. In essence, the Raise Carafe & Glass find their identity through their organic lines, encouraging the pieces to be raised when with friends, family and in everyday life."

— Broberg & Ridderstråle



Designed by	Broberg & Ridderstråle
Environment	Indoor
Contry of Production	Poland
Description	With their shapes inspired by modernist still life paintings yet interpreted in contemporary shapes and colors, the Raise Carafe & Glass have an inviting expression that encourages interaction when in use. With the slight raise of its foot, the glass has an elegant look while hinting its user to raise the glass up to a toast when with friends and family. Use the different colors together for a unique and playful table setting.
Material	Mouth-blown clear or colored glass. The traditional mouth-blown production makes each glass unique with small deviations in color, thickness, shape and surface.
Cleaning & Care	To care for and prolong the life of the Raise Carafe & Glass, we recommend hand-wash as this is the gentlest way of cleaning them. The Raise Carafe & Glass are dishwasher safe, but over time, this will tear on the glass clearness which can be avoided by washing them in hand. Not suitable for hot beverages or dishwasher program above 55°C. Due to the glassware's handmade nature that leads to varying weight and thickness of each piece, we do not recommend stacking more than two glasses on top of each other.

TESTS & CERTIFICATIONS

European Parliament and Council Regulation (EC) 1935/2004/EC

Commission Regulation (EC) No 2023/2006 of 22 December 2006 on good manufacturing practice for materials and articles intended to come into contact with food (GMP)

US Food and Drug Administration (FDA) Title 21 Code of Federal Regulations (CFR, 2011 Edition) as applicable

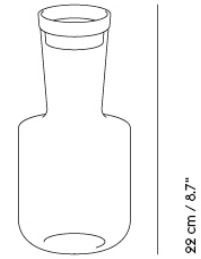

Ø 11 cm / 4.3"
Vol. 1 liter / 33.8 oz

Shipper Colli 1
Gross Weight (kg) 0.85
Net Weight (kg) 0.21
Warranty Period 5 Years

Pattern No.	Color	Contract Price	Lead Time
Ready-To-Ship US Warehouse			
MRSECF-BORG	Burnt Orange	USD 110.00	-
MRSECF-CLR	Clear	USD 110.00	-
MRSECF-DKBU	Dark Blue	USD 110.00	-

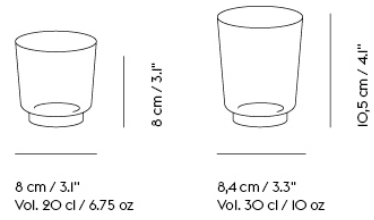
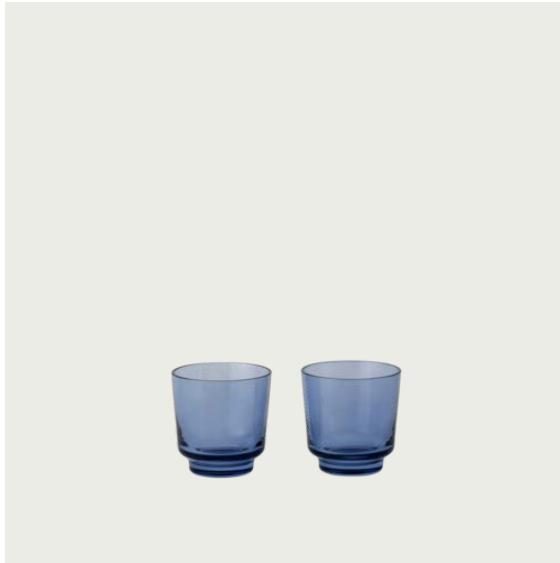

Shipper Colli 1
 Gross Weight (kg) 0.46
 Net Weight (kg) 0.13
 Warranty Period 5 Years

Pattern No.	Color	Contract Price	Lead Time
Ready-To-Ship US Warehouse			
MRSEGL20-BORG	Burnt Orange - 20 cl	USD 58.00	-
MRSEGL20-CLR	Clear - 20 cl	USD 58.00	-
MRSEGL20-DKBU	Dark Blue - 20 cl	USD 58.00	-
MRSEGL30-BORG	Burnt Orange - 30 cl	USD 68.00	-
MRSEGL30-CLR	Clear - 30 cl	USD 68.00	-
MRSEGL30-DKBU	Dark Blue - 30 cl	USD 68.00	-

REDUCE PAPER BIN

"Making Reduce Paper Bin from recycled material was the starting point for us. It was an exercise in reduction; of the design elements involved, our carbon footprint and in the end, the amount of waste in the office. Our process was about finding the most efficient form while making it sculptural and recognizable. Its racetrack shape has the advantage of easily fitting under a desk while the lid is gesture, a fold that gently rests on top of the bin, neatly hiding the trash bag below."

— Studio Tolvanen



Designed by	Studio Tolvanen
Environment	Indoor
Contry of Production	Denmark
Description	Reduce Paper Bin takes its name from the art of reducing; the amount of virgin material used in manufacturing, of rubbish and of form, to create a refined expression of an everyday object. Made using 100% recycled ABS plastic from post-consumer waste, it is a straightforward design with a soft and inviting shape. The beauty is in its details like the tactile, matte surface or the characteristic lid subtly concealing the bin bag. Reduce Paper Bin is an all-around object that feels equally at home in the kitchen, workshop and office.
Material	Produced using 100% recycled ABS plastic from post-consumer waste.
Cleaning & Care	Clean with a moist cloth. If necessary, use a little dish soap on the cloth.
Additional information	Can contain 12 liters.

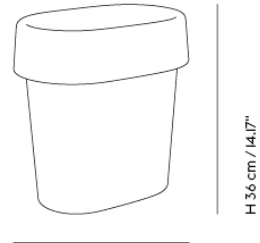

W 25,1 cm / 9.88"
 D 23,6 cm / 9.29"
 Vol. 14 liter / 3.7 gal

Shipper Colli 1
 Gross Weight (kg) 1.7
 Net Weight (kg) 1.36
 Warranty Period 5 years

Pattern No.	Color	Contract Price	Lead Time
Ready-To-Ship US Warehouse			
MRPBN-ANTH	Anthracite	USD 79.00	-
MRPBN-DKRD	Dark Red	USD 79.00	-
MRPBN-GREY	Grey	USD 79.00	-
MRPBN-LTGN	Light Green	USD 79.00	-

RELEVO RUG

"The Relevo rug came to be as it often does; on the drawing board with paper and pencil. We like to create a whole story around a project, this time with a rug that could be a sculpture in its own right, virtually changing the perception of a room. Relevo's swooping lines were inspired by land art and its sometimes furrowed, hypnotic paths in the soil. Relevo means relief in Latin, emblematic of the rug's geometric pattern, made by trimming the hand tufted rug in levels and thereby creating a subtle effect of light and shadow, a compelling visual expression."

— Studiopepe.



Design by	Studiopepe
Environment	Indoor
Country of Production	India
Description	Relevo is a soft rug with a distinctly sculptural quality. Its striking graphic pattern is produced by trimming the tufted wool in different levels, thereby creating an eye-catching shadowplay that gives a sense of being two-tone rather than monochrome. The rug's single rounded corner gives it a unique character, a dynamic expression in any setting.
Material	Made from 100% New Zealand wool, hand-tufted in India. Backing made of 100% cotton. Shedding is a natural occurrence which will decrease over time. Please note that the color of the Relevo Rug may vary depending on the wool's natural base color. Please note that all sizes of the Relevo Rug have a sizing tolerance of +/- 2%, meaning that the dimensions of the rug can differ by a maximum of 2%. Relevo does not require the use of a rug pad due to its weight.
Cleaning & Care	For general care, we recommend gentle vacuum cleaning on a regular basis (a vacuum cleaner without a brush head allows for more gentle vacuum cleaning, not disturbing the fibers of the rug). Excess material is a natural occurrence and will decrease over time. This can be removed with gentle vacuum cleaning. For cleaning of stains or spots, we recommend professional dry cleaning. Avoid cleaning with water, as this will damage the product.

TESTS & CERTIFICATIONS

US Flammability I6 CFR part I630/I63I

VOC CDPH 0I350 and VOC Bifma X7.I

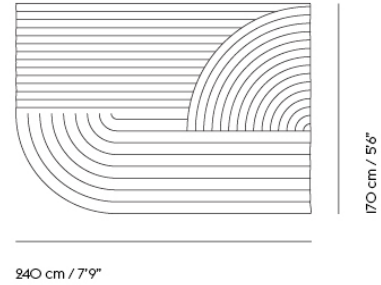

Shipper Colli 1
Gross Weight (kg) 21
Net Weight (kg) 19
Warranty Period 5 Years

Pattern No.	Color	Contract Price	Lead Time
Ready-To-Ship US Warehouse			
MRELVRG6693-BORG	Burnt Orange	USD 1,626.00	-
MRELVRG6693-DKGN	Dark Green	USD 1,626.00	-
MRELVRG6693-OWHT	Off-White	USD 1,626.00	-
MRELVRG6693-SAGN	Sage Green	USD 1,626.00	-

RELEVO RUG / 200 X 300 CM / 6'5" X 9'8"

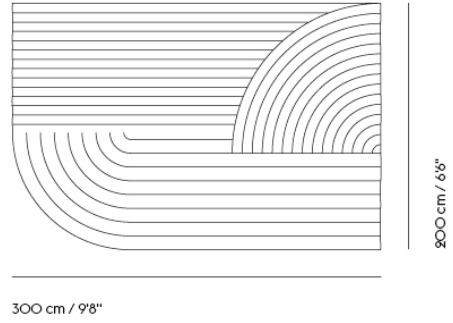

Shipper Colli 1
Gross Weight (kg) 30
Net Weight (kg) 28
Warranty Period 5 Years

Pattern No.	Color	Contract Price	Lead Time
Ready-To-Ship US Warehouse			
MRELVRG78116-BORG	Burnt Orange	USD 2,620.00	-
MRELVRG78116-DKGN	Dark Green	USD 2,620.00	-
MRELVRG78116-OWHT	Off-White	USD 2,620.00	-
MRELVRG78116-SAGN	Sage Green	USD 2,620.00	-

RESTORE SERIES

"I wanted for the Restore Series to have a humble character, allowing for it to easily fit into any environment. With its felt material made using fibers from recycled plastic bottles, the Restore Series has a curious and inviting expression while its corner slits bring a distinct look and added functionality to the design."

— Mika Tolvanen



Designed by	Mika Tolvanen
Environment	Indoor
Country of Production	China
Description	Made from a felt made of recycled plastic bottle fibers, the Restore Series is a functional and versatile storage unit that can be used for almost any object from laundry to blankets to children's toys. The Restore Series comes in a variety of colors and offers a textural, quirky addition to any home or professional space.
Material	The material is PET felt fibers. A percentage of the product comes from recycled plastic bottles, which are granulated, heated and blown like little fibers that are subsequently dyed. The fibers are worked together like mats, which can be pressed over heat-influenced forms that enables the material to maintain its shape.
Cleaning & Care	Vacuum. If necessary use moist cloth.

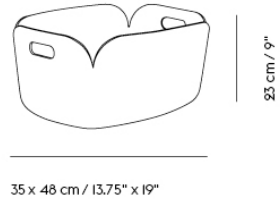

Shipper Colli 1
Gross Weight (kg) 0.9
Net Weight (kg) 0.8
Warranty Period 5 years

Pattern No.	Color	Contract Price	Lead Time
Ready-To-Ship US Warehouse			
MRESBKR-BEGN	Beige-Green	USD 167.00	-
MRESBKR-BLME	Black Mélange	USD 167.00	-
MRESBKR-BRGR	Brown Green	USD 167.00	-
MRESBKR-BORG	Burnt Orange	USD 167.00	-
MRESBKR-DKBW	Dark Brown	USD 167.00	-
MRESBKR-DKGN	Dark Green	USD 167.00	-
MRESBKR-DGRN	Dusty Green	USD 167.00	-
MRESBKR-DLAC	Dusty Lilac	USD 167.00	-
MRESBKR-GREY	Grey Mélange	USD 167.00	-
MRESBKR-LTBU	Light Blue	USD 167.00	-
MRESBKR-MBLU	Midnight Blue	USD 167.00	-
MRESBKR-SAND	Sand	USD 167.00	-

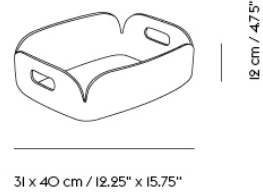

Shipper Colli	1
Gross Weight (kg)	0.55
Net Weight (kg)	0.5
Warranty Period	5 years

Pattern No.	Color	Contract Price	Lead Time
Ready-To-Ship US Warehouse			
MRESTR-BLME	Black Mélange	USD 142.00	-
MRESTR-BRGR	Brown Green	USD 142.00	-
MRESTR-DGRN	Dusty Green	USD 142.00	-
MRESTR-GREY	Grey Mélange	USD 142.00	-
MRESTR-LTBU	Light Blue	USD 142.00	-
MRESTR-MBLU	Midnight Blue	USD 142.00	-
MRESTR-SAND	Sand	USD 142.00	-

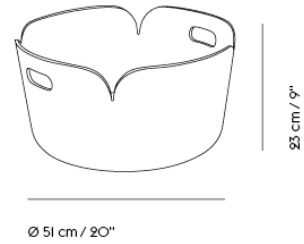

Shipper Colli	1
Gross Weight (kg)	1.2
Net Weight (kg)	1.2
Warranty Period	5 years

Pattern No.	Color	Contract Price	Lead Time
Ready-To-Ship US Warehouse			
MRESBKO-AQUA	Aqua ***	USD 184.00	-
MRESBKO-BLME	Black Mélange	USD 184.00	-
MRESBKO-BRGR	Brown Green	USD 184.00	-
MRESBKO-DGRN	Dusty Green	USD 184.00	-
MRESBKO-GREY	Grey Mélange	USD 184.00	-
MRESBKO-MBLU	Midnight Blue	USD 184.00	-

RHYTHM THROW

"The Rhythm Throw is a soft addition to any home. With its rhythm-like simple knit that brings the natural sheen and character of the yarn into play, the design has a tactile, modern expression. Made in Bolivian baby llama wool for a soft and comfortable feel."

— Aiayu



Designed by	Aiayu
Environment	Indoor
Country of Description	Bolivia
Description	<p>Featuring a tactile, understated structure for a modern look, the Rhythm Throw—designed by Copenhagen-based designers Aiayu—is made in baby llama wool with a rhythm-like structure, providing soft comfort to its user.</p> <p>The wool has been sourced in Bolivia with the factory cleaning 100% of its water post-production while reusing 75% of it. The factory also holds the WRAP-certification, ensuring production under lawful, humane and ethical conditions.</p>
Material	The Rhythm Throw is made from 100% baby llama wool.
Cleaning & Care	This product is made from 100% baby llama wool - a self-cleaning fiber that requires less washing than other materials. Simply air your product at first. If the need to wash it arises, hand wash is recommended at 30 degrees C using high-quality soap. Soak the product in water for 10 - 15 minutes before rinsing it in 30 degrees C water. Avoid twisting or pressing the water out. Let the product dry flat.

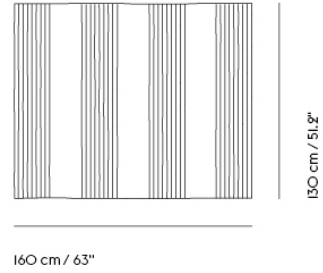

Shipper Colli |
Net Weight (kg) 0.9
Warranty Period 5 years

Pattern No.	Color	Contract Price	Lead Time
Ready-To-Ship US Warehouse			
MRHYTH-LTGY	Light Grey ***	USD 362.00	-
Ready-To-Ship EU Warehouse			
MRHYTH-DKGN	Dark Green ***	USD 362.00	-

RIDGE VASE

"The idea for the Ridge Vase came while traveling through different cities with a vase in mind, searching for details that had an architectural feel. Upon returning to our studio in Finland, we began sketching by hand and making mock-ups in paper and ceramics. With its vertical lines and unique shape, inspired by a doorway in Paris, the Ridge Vase presents a new way to place flowers through a modern expression along with a sculptural character when not in use. The Ridge Vase manipulates the oval form through its refined dent while adding the function of a small handle to use when moving the vase from one room to another."

— Studio Kaksikko



Designed by	Studio Kaksikko
Environment	Indoor
Country of Production	Portugal
Description	The Ridge Vase presents a new way to display flowers through its sculptural expression along with an artful character when not in use. The design features added functionality through its refined dent, allowing flowers to stand upright while also working as a subtle handle when moving the vase from one room to another.
Material	The Terracotta version is made from terracotta. The Off-White version is made from earthenware. Both are glazed on the inside and raw on the outside.
Cleaning & Care	The Ridge Vase's outer is untreated with a raw surface. When cleaning the Ridge Vase, we suggest that all usage of cleaning tools, such as a scrub sponge, that can get stuck in the rough surface is avoided. If the outer of your Ridge Vase needs additional cleaning, we recommend using an uncolored brush, such as a dish or nail brush, dipped in bit of warm water. Not dishwasher approved.

RIDGE VASE / H 16,5 CM / 6.7"

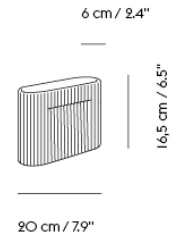
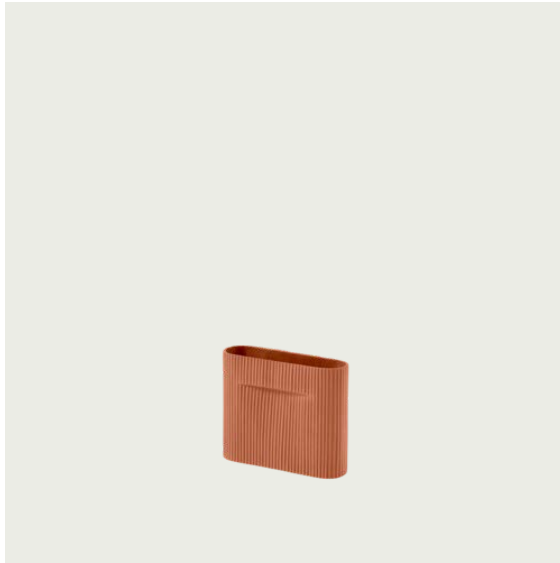

Shipper Colli |
Gross Weight (kg) |
Net Weight (kg) 0.75
Warranty Period 5 years

Pattern No.	Color	Contract Price	Lead Time
Ready-To-Ship US Warehouse			
MRIDVS7-BEIG	Beige	USD 93.00	-
MRIDVS7-OWHT	Off-White	USD 93.00	-
MRIDVS7-TERR	Terracotta	USD 93.00	-

RIDGE VASE / H: 35 CM / 13.8"

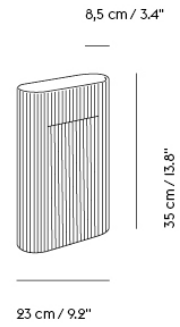

Shipper Colli 1
Gross Weight (kg) 2.5
Net Weight (kg) 1.8
Warranty Period 5 years

Pattern No.	Color	Contract Price	Lead Time
Ready-To-Ship US Warehouse			
MRIDVS14-BEIG	Beige	USD 146.00	-
MRIDVS14-OWHT	Off-White	USD 146.00	-
MRIDVS14-TERR	Terracotta	USD 146.00	-

RIDGE VASE / H: 48,5 CM / 19"

620

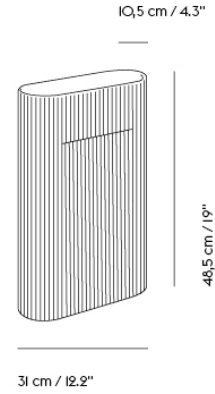

Shipper Colli	1
Gross Weight (kg)	4.8
Net Weight (kg)	4.4
Warranty Period	5 years

Pattern No.	Color	Contract Price	Lead Time
Ready-To-Ship US Warehouse			
MRIDVS19-BEIG	Beige	USD 278.00	-
MRIDVS19-OWHT	Off-White	USD 278.00	-
MRIDVS19-TERR	Terracotta	USD 278.00	-

SILENT VASE

"The Silent Vase was about reducing a vase to the simplest of expressions, allowing for its shapes to take centerstage and add character to the object. With its simple and almost airy expression, the Silent Vase adds an elegantly light touch to any atmosphere, both with and without flowers."

— Andreas Engesvik



Designed by	Andreas Engesvik
Environment	Indoor
Country of Production	China
Description	A form in mouth blown glass, the Silent Vase is Scandinavian design at its subtlest. Available in three sizes and multiple colors, the Silent Vase is a humble yet decorative addition to any space.
Material	Mouth-blown glass, cut and polished.
Cleaning & Care	Regular hand wash. No dishwashing.

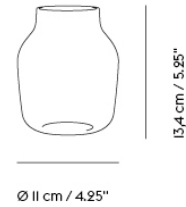
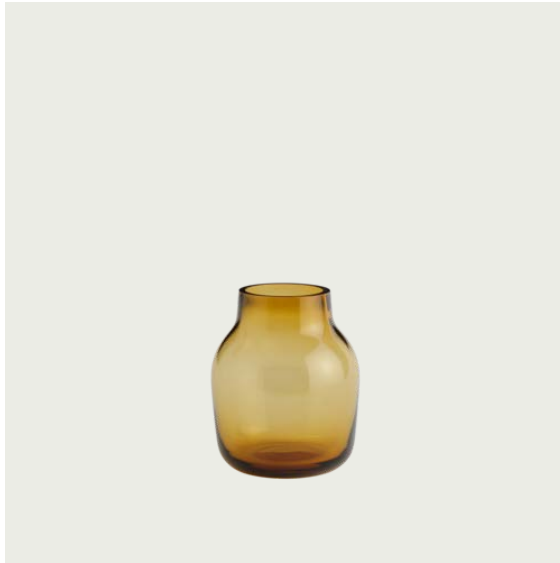

Shipper Colli 1
Gross Weight (kg) 1.6
Net Weight (kg) 1.5
Warranty Period 5 years

Pattern No.	Color	Contract Price	Lead Time
Ready-To-Ship US Warehouse			
MSILVS4-BORG	Burnt Orange	USD 58.00	-
MSILVS4-CLR	Clear	USD 58.00	-
MSILVS4-DKGN	Dark Green	USD 58.00	-

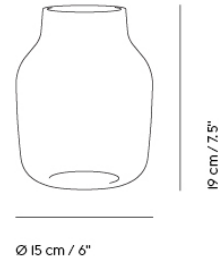

Shipper Colli	1
Gross Weight (kg)	1.85
Net Weight (kg)	1.7
Warranty Period	5 years

Pattern No.	Color	Contract Price	Lead Time
Ready-To-Ship US Warehouse			
MSILVS6-BORG	Burnt Orange	USD 89.00	-
MSILVS6-CLR	Clear	USD 89.00	-
MSILVS6-DKGN	Dark Green	USD 89.00	-

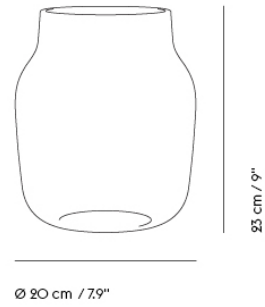

Shipper Colli 1
Gross Weight (kg) 2.4
Net Weight (kg) 2.2
Warranty Period 5 years

Pattern No.	Color	Contract Price	Lead Time
Ready-To-Ship US Warehouse			
MSILVS8-BORG	Burnt Orange	USD 114.00	-
MSILVS8-CLR	Clear	USD 114.00	-
MSILVS8-DKGN	Dark Green	USD 114.00	-

STORY PINBOARD

"We had this childhood memory of a cork pinboard being a magical surface onto which we could pin photos, souvenirs or leaves to create our own little universe, rearranging the objects to create new atmospheres and reflect whatever our mood was at the time. Designing the Story Pinboard was about translating this emotion into a new perspective through the warmth of cork in combination with a modern yet timeless expression."

— Big-Game



Designed by	Big-Game
Environment	Indoor
Country of Production	Portugal
Assembly Required	No
Description	The Story Pinboard brings subtle feelings of Scandinavian design into any work or creative context, whether in the home office, in a kids room or within the workplace. Produced in cork, a material that is sourced from the renewable bark of cork oak trees, the Story Pinboard recyclable in its entirety.
Material	Cork
Cleaning & Care	Wipe with a damp cloth.

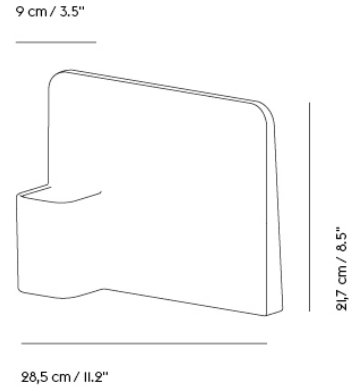
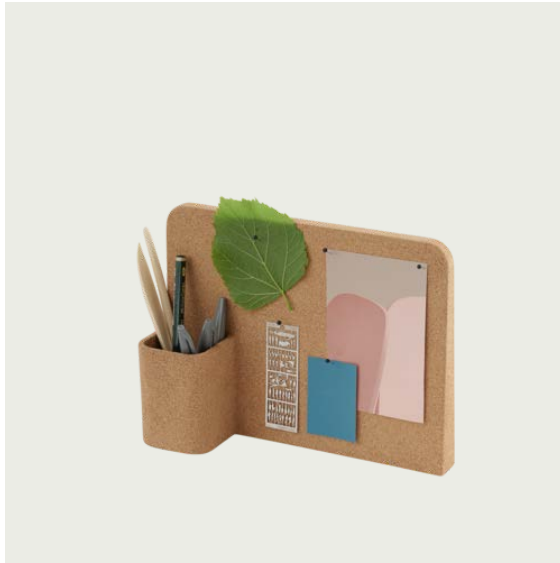

Shipper Colli 1
Gross Weight (kg) 1.15
Net Weight (kg) 0.452
Warranty Period 5 years

Pattern No.	Color	Contract Price	Lead Time
Ready-To-Ship US Warehouse			
MSTPBD	Cork	USD 89.00	-

TUB JUG

"Taking visual cues from the appearance of a fuel container, we wanted to bring a new expression to the traditional table jug. Through its wide opening and handle, the Tub Jug is a simple and useful object to serve as a carafe, watering can or even a vase. Created in ceramics, the Tub Jug features a clear function when in use as well as an aesthetic presence when placed on the table, a sideboard or shelf."

— Atelier BLI19



Designed by	Atelier BLI19
Environment	Indoor
Country of Production	Portugal
Description	The Tub Jug is an industrial carafe with a contemporary expression, echoed through its angled handle and wide opening that bring both function and character to the design. The design is made in glazed ceramics.
Material	The Tub Jug is made from stoneware with glaze.
Cleaning & Care	Clean with sponge and water. Dishwasher approved.

TESTS & CERTIFICATIONS

European Parliament and Council Regulation (EC) 1935/2004/EC

Commission Regulation (EC) No 2023/2006 of 22 December 2006 on good manufacturing practice for materials and articles intended to come into contact with food (GMP)

US Food and Drug Administration (FDA) Title 21 Code of Federal Regulations (CFR, 2011 Edition) as applicable

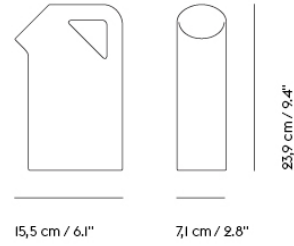

Shipper Colli 1
Gross Weight (kg) 1.3
Net Weight (kg) 1
Warranty Period 5 years

Pattern No.	Color	Contract Price	Lead Time
Ready-To-Ship US Warehouse			
MTUBJG-DKGN	Dark Green	USD 131.00	-
MTUBJG-PBLU	Pale Blue	USD 131.00	-
MTUBJG-SAND	Sand ***	USD 131.00	-

TWINE CUSHION

"With the Twine Cushion, we wanted to explore the possibilities of handknitting through a refined and modern expression. The result is an invitingly tactile design with distinct knitted pebbles, joined by the inherent softness of its baby llama wool material."

— Aiayu



Designed by	Aiayu
Environment	Indoor
Contry of Production	Bolivia
Description	<p>With a refined and modern expression, the Twine Cushion—designed by Copenhagen-based designers Aiayu—has an invitingly tactile character with distinct knitted pebbles, joined by the softness of its baby llama wool material.</p> <p>The wool of its outer has been sourced in Bolivia with the factory cleaning 100% of its water post-production while reusing 75% of it. The factory also holds the WRAP-certification, ensuring production under lawful, humane and ethical conditions.</p>
Material	The pillow case is made from 100% baby llama wool, the inner sham is 100% cotton and the fillling consists of 50% feather, 50% polyfiber.
Cleaning & Care	This product is made from 100% baby llama wool - a self-cleaning fiber that requires less washing than other materials. Simply air your product at first. If the need to wash it arises, hand wash is recommended at 30 degrees C using high-quality soap. Soak the product in water for 10 - 15 minutes before rinsing it.

TWINE CUSHION / 50 X 80 CM / 20 X 31"

630

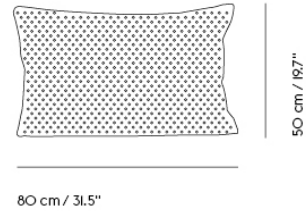

Shipper Colli 1
Gross Weight (kg) 1.2
Net Weight (kg) 0.65
Warranty Period 5 years

Pattern No.	Color	Contract Price	Lead Time
Ready-To-Ship EU Warehouse			
MTWICUS2032-BEGY	Beige-Grey ***	USD 310.00	-

VARJO RUG

“The idea was to create a geometric rug with multiple layers and dimensions. I wanted to give the first layer an easy understandable language and balanced color scheme. When you go one layer deeper a dynamic herringbone pattern arises and brings a new dimension and a surprising twist to the rug. Varjo is Finnish for shadow, which translates to the shadow effects that are created between the layers, as the darkest color block almost rises above the others, creating a three-dimensional expression.”

— Tina Ratzer



Designed by	Tina Ratzer
Environment	Indoor
Country of Production	India
Description	With its name meaning “shadows” in Finnish, the Varjo Rug hints towards how the woven texture creates a sense of shadow and light within the weave. With a unique pattern and discreet color-blocking, the Varjo Rug is hand-woven from 100% New Zealand wool.
Material	100% New Zealand lambswool. The wool is dyed and the rugs are woven by hand.
Cleaning & Care	For regular cleaning, vacuum the rugs. Clean stains instantly with sparkling water. The rugs should be turned every 6 months for maintenance purposes.
Spare Parts	Rug pad

TESTS & CERTIFICATIONS

US Flammability I6 CFR part I630/I631

VOC CDPH 01350 and VOC Bifma X7.1

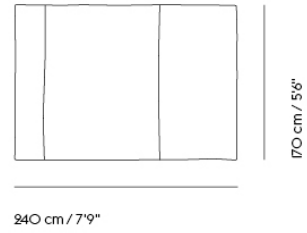

Shipper Colli 1
 Gross Weight (kg) 8.8
 Net Weight (kg) 7.8
 Warranty Period 5 years

Pattern No.	Color	Contract Price	Lead Time
Ready-To-Ship US Warehouse			
MVARRG6693-BLUE	Blue	USD 1,034.00	-
MVARRG6693-DKGN	Dark Green	USD 1,034.00	-
MVARRG6693-DKGY	Dark Grey	USD 1,034.00	-
Extras			
MPLYPA6681	Rug Pad - 160 x 230 cm / 5'2 x 7'5"	USD 89.00	-

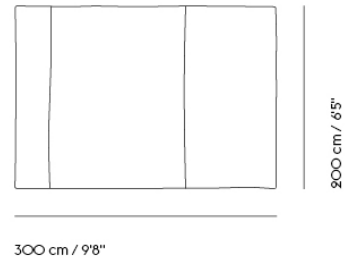

Shipper Colli 1
Gross Weight (kg) 14.7
Net Weight (kg) 12.8
Warranty Period 5 years

Pattern No.	Color	Contract Price	Lead Time
Ready-To-Ship US Warehouse			
MVARRG78116-BLUE	Blue	USD 1,675.00	-
MVARRG78116-DKGN	Dark Green	USD 1,675.00	-
MVARRG78116-DKGY	Dark Grey	USD 1,675.00	-
Extras			
MPLYPA78116	Rug Pad - 190 x 290 cm / 6'2 x 9'5"	USD 110.00	-

WAVE TRAY

"We sought for the Wave Tray to bring a refined sentiment to the otherwise raw materiality of metal; something that we saw typically used in more industrial contexts. Through its organic form in stainless steel that is inspired by the undulations of a wave, from which the design also takes its name, the Wave Tray has a simple, graphic expression that, in pairing with its grander size, makes a true statement. With its unique shape and understated materiality, the Wave Tray brings elegant rhythm, subtle vibrations and a graphic character into everyday life."

— Cara / Davide



Designed by	Cara / Davide
Environment	Indoor
Country of Production	Croatia
Description	The Wave Tray brings a refined sentiment to the otherwise raw materiality of metal. Through its organic form that has been shaped in stainless steel, the expression is inspired by the undulations of a wave. The Wave Tray has a simple yet graphic expression that, paired with its grand sizes, makes a true statement in any setting.
Material	Stainless steel
Cleaning & Care	Clean the surface with a lint-free cloth wrung in lukewarm water and a mild detergent. Wipe the surface with a dry lint-free cloth. Stubborn stains and rust may be removed by carefully cleaning it with a light-abrasive cleaner that is suitable for stainless steel and by only following the lines in the material and never in circles, as this can cause scratches to its surface. Please be aware that this process can change the original polishing finish of the surface.

TESTS & CERTIFICATIONS

European Parliament and Council Regulation (EC) 1935/2004/EC

Commission Regulation (EC) No 2023/2006 of 22 December 2006 on good manufacturing practice for materials and articles intended to come into contact with food (GMP).

US Food and Drug Administration (FDA) Title 21 Code of Federal Regulations (CFR, 2011 Edition) as applicable.

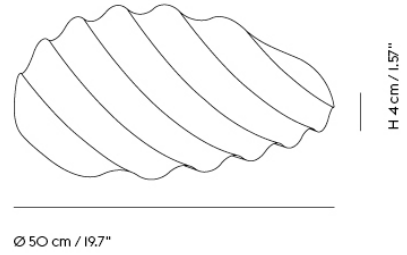

Shipper Colli 1
Gross Weight (kg) 2.8
Net Weight (kg) 2
Warranty Period 5 Years

Pattern No.	Color	Contract Price	Lead Time
Ready-To-Ship US Warehouse			
MWVTY	Steel	USD 278.00	-

PRODUCT

Enfold Sideboard - Low - Oak/Grey
 Enfold Sideboard - Tall - Oak/Dusty Green
 Enfold Sideboard - Tall - Black/Black
 Enfold Sideboard - Tall - Oak/Black
 Enfold Sideboard - Tall - Oak/Grey
 Enfold Sideboard Low 124x45x63cm Black/Black
 Enfold Sideboard Low 124x45x63cm Oak/Deep Red
 Enfold Sideboard Low Long 186x45x48cm Black/Black
 Enfold Sideboard Low Long 186x45x48cm Oak/Black
 Enfold Sideboard Low Long 186x45x48cm Oak/D.Green
 Enfold Sideboard Low Long 186x45x48cm Oak/Deep Red
 Enfold Sideboard Low Long 186x45x48cm Oak/Grey
 Enfold Sideboard Tall 100x45x85cm Oak/Deep Red
 Enfold Sideboard Tall Wide 148x45x85cm Black/Black
 Enfold Sideboard Tall Wide 148x45x85cm Oak/D.Green
 Enfold Sideboard Tall Wide 148x45x85cm Oak/DeepRed
 Enfold Sideboard Tall Wide 148x45x85cm Oak/Grey
 Enfold Sideboard Tall Wide 148x45x85cm Oak/Black
 Fiber ArmChair Tube FSC - Black/Black

Fiber ArmChair Tube FSC - DGRN/DGRN

Fiber ArmChair Tube FSC - Grey/Grey
 Fiber ArmChair Tube FSC - Ochre/Black

Fiber ArmChair Tube FSC - White/White
 Fiber ArmChair Wood BC FSC - Black/Black

Fiber ArmChair Wood BC FSC - DGRN/DGRN

Fiber ArmChair Wood BC FSC - Grey/Grey

Fiber ArmChair Wood BC FSC - Ochre/Oak
 Fiber ArmChair Wood BC FSC - White/Oak
 Fiber Bar Stool Tube H65 FSC - Black/Black

Fiber Bar Stool Tube H65 Grey/Grey-WHEN OOS 58904
 Fiber Bar Stool Tube H65 White/White-OOS 58905
 Fiber Bar Stool Tube H75 Black/Black-OOS 58906

Fiber Bar Stool Tube H75 Grey/Grey-WHEN OOS 58907
 Fiber Bar Stool Tube H75 White/White-OOS 58908
 Fiber Bar Stool w.Back Tube H65 FSC - Black/Black

Fiber Bar Stool w.Back Tube H65 FSC - White/White
 Fiber Bar Stool w.Back Tube H65 Grey/Grey-OOS58918
 Fiber Bar Stool w.Back Tube H75 FSC - Black/Black

Fiber Bar Stool w.Back Tube H75 FSC - Grey/Grey
 Fiber Bar Stool w.Back Tube H75 FSC - OCHRE/BLACK

Fiber Bar Stool w.Back Tube H75 White/White-58922
 Fiber Bar Stool w.Back Wood H65 FSC - Black/Black

Fiber Bar Stool w.Back Wood H65 FSC - Black/STDB
 Fiber Bar Stool w.Back Wood H65 FSC - Grey/Grey
 Fiber Bar Stool w.Back Wood H65 White/Oak-58925
 Fiber Bar Stool w.Back Wood H75 Black/SDBrwn
 Fiber Bar Stool w.Back Wood H75 FSC - Black/Black

Fiber Bar Stool w.Back Wood H75 FSC - White/Oak
 Fiber Bar Stool w.Back Wood H75 Grey/Grey-58927
 Fiber Bar Stool Wood H65 Black/Black- OOS 58911

Fiber Bar Stool Wood H65 Grey/Grey-WHEN OOS 58912
 Fiber Bar Stool Wood H65 White/Oak-WHEN OOS 58913
 Fiber Bar Stool Wood H75 FSC - Black/Black

Fiber Bar Stool Wood H75 FSC - White/Oak
 Fiber Bar Stool Wood H75 Grey/Grey-WHEN OOS 58915
 Fiber Conf Arm Sw Gas Tilt Castor - Remix GREY_133
 Fiber Conf Arm Swivel v2 - Refine - BLCK_Cognac
 Fiber ConfArm SwGas TiltCast v2 Refine-BLCK_Cognac
 Fiber Conference Arm Swivel v2 - Remix - GREY_133
 Fiber Lounge Tube Full Uph Divina BLACK_154
 Fiber Lounge Tube Full Uph Remix GREY_133
 Fiber Lounge Tube Full Uph St. Trio BLACK_236
 Fiber Lounge Wood Full Uph Remix GREY_133
 Fiber Outdoor Armchair Anthracite Black
 Fiber Outdoor Armchair Brown Red
 Fiber Outdoor Armchair Dusty Green
 Fiber Outdoor Armchair Grey
 Fiber Outdoor Side Chair Anthracite Black
 Fiber Outdoor Side Chair Brown Red
 Fiber Outdoor Side Chair Dusty Green
 Fiber Outdoor Side Chair Grey
 Fiber Side A-Base FSC - Chrome/Grey
 Fiber Side A-Base FSC - Chrome/White
 Fiber Side Chair Tube FSC - Black/Black

Fiber Side Chair Tube FSC - DGRN/DGRN
 Fiber Side Chair Tube FSC - Grey/Grey
 Fiber Side Chair Tube FSC - Ochre/Black

Fiber Side Chair Tube FSC - White/White
 Fiber Side Chair Wood BC FSC - Black/Black

Fiber Side Chair Wood BC FSC - DGRN/DGRN

Fiber Side Chair Wood BC FSC - Grey/Grey
 Fiber Side Chair Wood BC FSC - Ochre/Oak
 Fiber Side Chair Wood BC FSC - White/Oak
 Fiber Soft Arm Swivel - Ecriture GREY_240
 Fiber Soft Arm Tube - Ecriture GREY_240
 Fiber Soft Arm Wood - Ecriture OAK_240

COLOR CODES

RAL 7044
 RAL 7033
 RAL 7021
 RAL 7021
 RAL 7044
 RAL 7021
 RAL 8015
 RAL 7021
 RAL 7021
 RAL 7033
 RAL 8015
 RAL 7044
 RAL 8015
 RAL 7021
 RAL 7033
 RAL 8015
 RAL 7044
 RAL 7021
 SHELL: Black, BASE: Black (RAL 7021)

SHELL: Dusty Green, BASE: Dusty Green (RAL 7033)

SHELL: Grey, BASE: Grey RAL 7030
 SHELL: Ochre, BASE: Black (RAL 7021)

SHELL: White, BASE: White (RAL 9010)
 BASE: RAL 7021

BASE: RAL 7033

BASE: RAL 7021

-
 SHELL: Black, BASE: Black (RAL 7021)

SHELL: Grey, BASE: Grey RAL 7030
 SHELL: White, BASE: White (RAL 9010)
 SHELL: Black, BASE: Black (RAL 7021)

SHELL: Grey, BASE: Grey RAL 7030
 SHELL: White, BASE: White (RAL 9010)
 SHELL: Black, BASE: Black (RAL 7021)

SHELL: White, BASE: White (RAL 9010)
 SHELL: Grey, BASE: Grey RAL 7030
 SHELL: Black, BASE: Black (RAL 7021)

SHELL: Grey, BASE: Grey RAL 7030
 SHELL: Ochre, BASE: Black (RAL 7021)

SHELL: White, BASE: White (RAL 9010)
 SHELL: Black, BASE: Black (RAL 7021)

-
 SHELL: Grey, BASE: Grey RAL 7030
 SHELL: White, BASE: Oak
 -
 SHELL: Black, BASE: Black (RAL 7021)

SHELL: White, BASE: Oak
 SHELL: Grey, BASE: Grey RAL 7030
 SHELL: Black, BASE: Black (RAL 7021)

SHELL: Grey, BASE: Grey RAL 7030
 SHELL: White, BASE: Oak
 SHELL: Black, BASE: Black (RAL 7021)

SHELL: White, BASE: Oak
 SHELL: Grey, BASE: Grey RAL 7030
 RAL 7030
 RAL 7021
 RAL 7021
 RAL 7030
 Divina I54 / Black (RAL 7021)
 SHELL: Remix 133, BASE: Grey (Ral 7030)
 Steelcut Trio 236 / Black (RAL 7021)
 SHELL: Remix 133, BASE: Grey (Ral 7030)
 RAL 7021
 RAL 8017
 RAL 7033
 RAL 7044
 RAL 7021
 RAL 8017
 RAL 7033
 RAL 7044
 SHELL: Grey/ BASE: Chrome
 SHELL: White/ BASE: Chrome
 SHELL: Black, BASE: Black (RAL 7021)

SHELL: Grey, BASE: Grey RAL 7030
 SHELL: Grey, BASE: Grey RAL 7030
 SHELL: Ochre, BASE: Black (RAL 7021)

SHELL: White, BASE: White (RAL 9010)
 SHELL: Black, BASE: Black (RAL 7021)

SHELL: Green, BASE: Green (RAL 7033)

SHELL: Grey, BASE: Grey RAL 7030
 SHELL: Ochre, BASE: Oak
 SHELL: White, BASE: Oak
 Base: RAL 7030
 Base: RAL 7030
 Base: RAL 7030

NEAREST MATCH

NCS S 2502-Y, Pantone 413C
 NCS S 5005-G50Y, Pantone 416C
 NCS S 8502-B, Pantone 426C
 NCS S 8502-B, Pantone 426C
 NCS S 2502-Y, Pantone 413C
 NCS S 8502-B, Pantone 426C
 NCS S 6020-Y8OR
 NCS S 8502-B, Pantone 426C
 NCS S 8502-B, Pantone 426C
 NCS S 8502-B, Pantone 426C
 NCS S 5005-G50Y, Pantone 416C
 NCS S 6020-Y8OR
 NCS S 2502-Y, Pantone 413C
 NCS S 6020-Y8OR
 NCS S 8502-B, Pantone 426C
 NCS S 5005-G50Y, Pantone 416C
 NCS S 6020-Y8OR
 NCS S 2502-Y, Pantone 413C
 NCS S 8502-B, Pantone 426C
 SHELL: RAL 7021, NCS S8500-N, BASE: NCS S 8500-N, Pantone 426 C
 SHELL: RAL 7033, NCS S 5005-G50Y, BASE: NCS S 5005-G50Y, Pantone 416 C
 SHELL: RAL 7030, NCS S 4502-Y, BASE: NCS S 4502-Y
 SHELL: RAL IOII, NCS S 3040-Y2OR, BASE: NCS S 8500-N, Pantone 426 C
 SHELL: RAL 9010, NCS S 0502-Y, BASE: NCS S 0502-Y
 SHELL: RAL 7021, NCS S 8500-N, BASE: NCS S 8500-N, Pantone 426 C
 SHELL: RAL 7033, NCS S 5005-G50Y, BASE: NCS S 5005-G50Y, Pantone 416 C
 SHELL: RAL 7021, NCS S 8500-N, BASE: NCS S 8500-N, Pantone 426 C
 SHELL: RAL 9011, NCS S 3040-Y2OR
 SHELL: RAL 9010, NCS S 0502-Y
 SHELL: RAL 7021, NCS S8500-N, BASE: NCS S 8500-N, Pantone 426 C
 SHELL: RAL 7030, NCS S 4502-Y, BASE: NCS S 4502-Y
 SHELL: RAL 9010, NCS S 0502-Y, BASE: NCS S 0502-Y
 SHELL: RAL 7021, NCS S8500-N, BASE: NCS S 8500-N, Pantone 426 C
 SHELL: RAL 7030, NCS S 4502-Y, BASE: NCS S 4502-Y
 SHELL: RAL 9010, NCS S 0502-Y, BASE: NCS S 0502-Y
 SHELL: RAL 7021, NCS S8500-N, BASE: NCS S 8500-N, Pantone 426 C
 SHELL: RAL 7030, NCS S 4502-Y, BASE: NCS S 4502-Y
 SHELL: RAL IOII, NCS S 3040-Y2OR, BASE: NCS S 8500-N, Pantone 426 C
 SHELL: RAL 9010, NCS S 0502-Y, BASE: NCS S 0502-Y
 SHELL: RAL 7021, NCS S8500-N, BASE: NCS S 8500-N, Pantone 426 C
 SHELL: RAL 7021, NCS S 8500-N, BASE: NCS S 8500-N, Pantone 426 C
 SHELL: RAL 9010, NCS S 0502-Y
 SHELL: RAL 7030, NCS S 4502-Y, BASE: NCS S 4502-Y
 SHELL: RAL 9010, NCS S 0502-Y
 SHELL: RAL 7021, NCS S8500-N, BASE: NCS S 8500-N, Pantone 426 C
 SHELL: RAL 7030, NCS S 4502-Y, BASE: NCS S 4502-Y
 SHELL: RAL IOII, NCS S 3040-Y2OR, BASE: NCS S 4502-Y
 NCS S 4502-Y
 NCS S 8500-N, Pantone 426 C
 NCS S 8500-N, Pantone 426 C
 NCS S 4502-Y
 NCS S 8500-N, Pantone 426 C
 NCS S 4502-Y,
 -
 -
 -
 -
 -
 -
 -
 SHELL: RAL 7030, NCS S 4502-Y
 SHELL: RAL 9010, NCS S 0502-Y
 SHELL: RAL 7021, NCS S8500-N, BASE: NCS S 8500-N, Pantone 426 C
 SHELL: RAL 7030, NCS S 4502-Y, BASE: NCS S 4502-Y
 SHELL: RAL 7030, NCS S 4502-Y, BASE: NCS S 4502-Y
 SHELL: RAL IOII, NCS S 3040-Y2OR, BASE: NCS S 8500-N, Pantone 426 C
 SHELL: RAL 9010, NCS S 0502-Y, BASE: NCS S 0502-Y
 SHELL: RAL 7021, NCS S8500-N, BASE: NCS S 8500-N, Pantone 426 C
 SHELL: RAL 7033, NCS S 5005-G50Y, BASE: NCS S 5005-G50Y, Pantone 416 C
 SHELL: RAL 7030, NCS S 4502-Y, BASE: NCS S 4502-Y
 SHELL: RAL IOII, NCS S 3040-Y2OR
 SHELL: RAL 9010, NCS S 0502-Y
 Base: NCS S 4502-Y
 Base: NCS S 4502-Y
 Base: NCS S 4502-Y

PRODUCT

Flow Trolley - 2-Layer - Blue-Grey
 Flow Trolley - 2-Layer - Grey
 Flow Trolley - 3-Layer - Blue-Grey
 Flow Trolley - 3-Layer - Grey
 Linear Steel Armchair - Black
 Linear Steel Armchair - Burnt Orange
 Linear Steel Armchair - Dark Green
 Linear Steel Armchair - Grey
 Linear Steel Armchair - Pale Blue
 Linear Steel Armchair - White
 Linear Steel Bar Stool (H75) - Black
 Linear Steel Bar Stool (H75) - Burnt Orange
 Linear Steel Bar Stool (H75) - Dark Green
 Linear Steel Bar Stool (H75) - Grey
 Linear Steel Bar Stool (H75) - Pale Blue
 Linear Steel Bench Top/Legs Black 110cm V2
 Linear Steel Bench Top/Legs Black 170cm V2
 Linear Steel Bench Top/Legs Burnt Orange 110cm V2
 Linear Steel Bench Top/Legs Burnt Orange 170cm V2
 Linear Steel Bench Top/Legs Dark Green 110cm V2
 Linear Steel Bench Top/Legs Dark Green 170cm V2
 Linear Steel Bench Top/Legs Grey 110cm V2
 Linear Steel Bench Top/Legs Grey 170cm V2
 Linear Steel Bench Top/Legs Pale Blue 110cm V2
 Linear Steel Bench Top/Legs Pale Blue 170cm V2
 Linear Steel Bench Top/Legs White 110cm V2
 Linear Steel Bench Top/Legs - White - 170cm
 Linear Steel Cafe Table Black - H105 - 70x70cm
 Linear Steel Cafe Table Black - H105 - 070cm
 Linear Steel Cafe Table Black - H95 - 70x70cm
 Linear Steel Cafe Table Black - H95 - 070cm
 Linear Steel Cafe Table Burnt Orange H105 70x70cm
 Linear Steel Cafe Table Burnt Orange H105 - 070cm
 Linear Steel Cafe Table Burnt Orange H95 - 70x70cm
 Linear Steel Cafe Table Burnt Orange H95 - 070cm
 Linear Steel Cafe Table Dark Green - H105 - 070cm
 Linear Steel Cafe Table Dark Green - H95 - 70x70cm
 Linear Steel Cafe Table Dark Green - H95 - 070cm
 Linear Steel Cafe Table Dark Green - H105 - 70x70cm
 Linear Steel Cafe Table Grey - H105 - 70x70cm
 Linear Steel Cafe Table Grey - H105 - 070cm
 Linear Steel Cafe Table Grey - H95 - 70x70cm
 Linear Steel Cafe Table Grey - H95 - 070cm
 Linear Steel Cafe Table Pale Blue - H105 - 70x70cm
 Linear Steel Cafe Table Pale Blue - H105 - 070cm
 Linear Steel Cafe Table Pale Blue - H95 - 70x70cm
 Linear Steel Cafe Table Pale Blue - H95 - 070cm
 Linear Steel Cafe Table V2 B, Orange H73 - 70x70cm
 Linear Steel Cafe Table V2 Black - H73 - 70x70cm
 Linear Steel Cafe Table V2 Black - H73 - 070cm
 Linear Steel Cafe Table V2 Burnt Orange H73 - 070cm
 Linear Steel Cafe Table V2 Dark Green - H73 - 070cm
 Linear Steel Cafe Table V2 Dark Green H73 - 70x70cm
 Linear Steel Cafe Table V2 Grey - H73 - 70x70cm
 Linear Steel Cafe Table V2 Grey - H73 - 070cm
 Linear Steel Cafe Table V2 Pale Blue H73 - 70x70cm
 Linear Steel Cafe Table V2 Pale Blue H73 - 070cm
 Linear Steel Coffee Table 042 / H47 - Black
 Linear Steel Coffee Table 042 / H47 - Burnt Orange
 Linear Steel Coffee Table 042 / H47 - Dark Green
 Linear Steel Coffee Table 042 / H47 - Grey
 Linear Steel Coffee Table 042 / H47 - Pale Blue
 Linear Steel Coffee Table 070 / H40 - Black
 Linear Steel Coffee Table 070 / H40 - Burnt Orange
 Linear Steel Coffee Table 070 / H40 - Dark Green
 Linear Steel Coffee Table 070 / H40 - Grey
 Linear Steel Coffee Table 070 / H40 - Pale Blue
 Linear Steel Counter Stool (H65) - Black
 Linear Steel Counter Stool (H65) - Burnt Orange
 Linear Steel Counter Stool (H65) - Dark Green
 Linear Steel Counter Stool (H65) - Grey
 Linear Steel Counter Stool (H65) - Pale Blue
 Linear Steel Lounge Chair - Pale Blue
 Linear Steel Lounge Chair - Black
 Linear Steel Lounge Chair - Burnt Orange
 Linear Steel Lounge Chair - Dark Green
 Linear Steel Lounge Chair - Grey
 Linear Steel Side Chair - Black
 Linear Steel Side Chair - Burnt Orange
 Linear Steel Side Chair - Dark Green
 Linear Steel Side Chair - Grey
 Linear Steel Side Chair - Pale Blue
 Linear Steel Side Chair - White
 Linear Steel Table Top/Legs Black 140x75cm V2
 Linear Steel Table Top/Legs Black 200x75cm V2
 Linear Steel Table Top/Legs Black - 220x90cm V3
 Linear Steel Table Top/Legs Burnt Orange 140x75cm V2
 Linear Steel Table Top/Legs Burnt Orange 200x75cm V2
 Linear Steel Table Top/Legs Burnt Orange 220x90cm V3
 Linear Steel Table Top/Legs Dark Green 140x75cm V2
 Linear Steel Table Top/Legs Dark Green 200x75cm V2
 Linear Steel Table Top/Legs Dark Green 220x90cm V3
 Linear Steel Table Top/Legs Grey 140x75cm V2
 Linear Steel Table Top/Legs Grey 200x75cm V2
 Linear Steel Table Top/Legs Grey - 220x90cm V3
 Linear Steel Table Top/Legs Pale Blue 140x75cm V2
 Linear Steel Table Top/Legs Pale Blue 200x75cm V2
 Linear Steel Table Top/Legs Pale Blue 220x90cm V3
 Linear Steel Table Top/Legs White 200x75cm V2
 Linear Sys. E. Mod. - Lam. - White - 142x120
 Linear Sys. E. Mod. - Lam. - White - 142x240
 Linear Sys. E. Mod. - N. Lam. - BLCK - 142x24
 Linear Sys. E. Mod. - N. Lam. - BLCK - 142x120
 Linear Sys. M. Mod. - Lam - White - 142x240
 Linear Sys. M. Mod. - Oak/B. N. Lam. - 142x240

COLOR CODES

RAL 5008
 RAL 7044
 RAL 5008
 RAL 7044
 Black (RAL 7021)
 Burnt Orange (RAL 8001)
 Dark Green (RAL 6012)
 Grey (RAL 7044)
 Pale Blue (NCS 4020-B)
 White (RAL 1013)
 Black (RAL 7021)
 Burnt Orange (RAL 8001)
 Dark Green (RAL 6012)
 Grey (RAL 7044)
 Pale Blue (NCS 4020-B)
 Black (RAL 7021)
 Black (RAL 7021)
 Burnt Orange (RAL 8001)
 Burnt Orange (RAL 8001)
 Dark Green (RAL 6012)
 Dark Green (RAL 6012)
 Grey (RAL 7044)
 Grey (RAL 7044)
 Pale Blue (NCS 4020-B)
 Pale Blue (NCS 4020-B)
 Off-White (RAL 1013)
 White (RAL 1013)
 Black (RAL 7021)
 Black (RAL 7021)
 Black (RAL 7021)
 Black (RAL 7021)
 Burnt Orange (RAL 8001)
 Burnt Orange (RAL 8001)
 Burnt Orange (RAL 8001)
 Burnt Orange (RAL 8001)
 Dark Green (RAL 6012)
 Dark Green (RAL 6012)
 Dark Green (RAL 6012)
 Dark Green (RAL 6012)
 Grey (RAL 7044)
 Grey (RAL 7044)
 Grey (RAL 7044)
 Grey (RAL 7044)
 Pale Blue (NCS 4020-B)
 Pale Blue (NCS 4020-B)
 Pale Blue (NCS 4020-B)
 Pale Blue (NCS 4020-B)
 Burnt Orange (RAL 8001)
 Black (RAL 7021)
 Black (RAL 7021)
 Burnt Orange (RAL 8001)
 Dark Green (RAL 6012)
 Dark Green (RAL 6012)
 Grey (RAL 7044)
 Grey (RAL 7044)
 Pale Blue (NCS 4020-B)
 Pale Blue (NCS 4020-B)
 RAL 7021
 RAL 8001
 RAL 6012
 RAL 7044
 NCS 4020-B
 RAL 7021
 RAL 8001
 RAL 6012
 RAL 7044
 NCS 4020-B
 RAL 7021
 RAL 8001
 RAL 6012
 Grey (RAL 7044)
 Pale Blue (NCS 4020-B)
 RAL 1013
 Black (RAL 7021)
 Black (RAL 7021)
 Black (RAL 7021)
 Burnt Orange (RAL 8001)
 Burnt Orange (RAL 8001)
 Burnt Orange (RAL 8001)
 Dark Green (RAL 6012)
 Dark Green (RAL 6012)
 Dark Green (RAL 6012)
 Grey (RAL 7044)
 Grey (RAL 7044)
 Grey (RAL 7044)
 Pale Blue (NCS 4020-B)
 Pale Blue (NCS 4020-B)
 Pale Blue (NCS 4020-B)
 Off-White (RAL 1013)
 Formica F1040 Alpino
 Formica F1040 Alpino
 FENIX NTM 0720 Nero Ingo
 FENIX NTM 0720 Nero Ingo
 Formica F1040 Alpino
 FENIX NTM 0720 Nero Ingo

NEAREST MATCH

-
 -
 -
 -
 NCS S 8002-B
 -
 NCS S 8005-B80G, Pantone 447 C
 NCS-S 2502-Y, Pantone 413 C
 -
 NCS S 1005-Y30R
 NCS S 8002-B
 -
 NCS S 8005-B80G, Pantone 447 C
 -
 NCS S 8002-B
 NCS S 8002-B
 -
 NCS S 8005-B80G, Pantone 447 C
 NCS S 8005-B80G, Pantone 447 C
 NCS-S 2502-Y, Pantone 413 C
 NCS-S 2502-Y, Pantone 413 C
 -
 NCS S 1005-Y30R
 NCS S 1005-Y30R
 NCS S 8002-B
 NCS S 8002-B
 NCS S 8002-B
 NCS S 8002-B
 -
 -
 -
 -
 -
 NCS S 8005-B80G, Pantone 447 C
 NCS S 8005-B80G, Pantone 447 C
 NCS S 8005-B80G, Pantone 447 C
 NCS S 8005-B80G, Pantone 447 C
 NCS-S 2502-Y, Pantone 413 C
 NCS-S 2502-Y, Pantone 413 C
 NCS-S 2502-Y, Pantone 413 C
 NCS-S 2502-Y, Pantone 413 C
 -
 NCS S 8002-B
 NCS S 8002-B
 -
 NCS S 8005-B80G, Pantone 447 C
 NCS S 8005-B80G, Pantone 447 C
 NCS-S 2502-Y, Pantone 413 C
 NCS-S 2502-Y, Pantone 413 C
 -
 NCS S 8002-B
 -
 NCS S 8005-B80G, Pantone 447 C
 NCS-S 2502-Y, Pantone 413 C
 -
 NCS S 8002-B
 -
 NCS S 8005-B80G, Pantone 447 C
 NCS-S 2502-Y, Pantone 413 C
 -
 NCS S 8002-B
 -
 NCS S 8005-B80G, Pantone 447 C
 NCS-S 2502-Y, Pantone 413 C
 -
 NCS S 8002-B
 -
 NCS S 8005-B80G, Pantone 447 C
 NCS-S 2502-Y, Pantone 413 C
 -
 NCS S 1005-Y30R
 RAL9010
 RAL9010
 NCS S 8500-N, RAL DESIGN/OOO 25 OO
 NCS S 8500-N, RAL DESIGN/OOO 25 OO
 RAL9010
 NCS S 8500-N, RAL DESIGN/OOO 25 OO

PRODUCT

Linear Sys. T. - Con. 1 - Lam. - White - W142
 Linear Sys. T. - Con. 1 - Lam. - White - W142
 Linear Sys. T. - Con. 1 - Oak./B. N. Lam. - W142
 Linear Sys. T. - Con. 1 - Oak./B. N. Lam. - W142
 Linear Sys. T. - Con. 2 - Lam. - White - W142
 Linear Sys. T. - Con. 2 - Lam. - White - W142
 Linear Sys. T. - Con. 2 - Oak./B. N. Lam. - W142
 Linear Sys. T. - Con. 2 - Oak./B. N. Lam. - W142
 Linear Sys. T. - Con. 3 - Lam. - White - W142
 Linear Sys. T. - Con. 3 - Oak./B. N. Lam. - W142
 Linear Sys. T. - Lam. - White - 24Ocm - W142
 Linear Sys. T. - Oak./B. N. Lam. - 24Ocm - W142
 Loft Bar H65 - Black/Black

Loft Bar H65 - Black/Oak
 Loft Bar H65 - Dusty Green/Oak
 Loft Bar H65 - Oak/Deep Red
 Loft Bar H65 - Oak/Grey
 Loft Bar H75 - Black/Black

Loft Bar H75 - Black/Oak
 Loft Bar H75 - Dusty Green/Oak
 Loft Bar H75 - Oak/Deep Red
 Loft Bar H75 - Oak/Grey
 Loft Chair - Black/Black
 Loft Chair - Black/Oak
 Loft Chair - Dusty Green/Oak
 Loft Chair - Oak/Deep Red
 Loft Chair - Oak/Grey
 Loft Chair - Stained Dark Brown/Black
 Loft Chair - White/Oak
 Loft Chair W. Arm - Black/Black
 Loft Chair W. Arm - Black/Oak
 Loft Chair W. Arm - Oak/Deep Red
 Loft Chair W. Arm - Oak/Dusty Green
 Loft Chair W. Arm - Oak/Grey
 Loft Chair W. Arm - Stained Dark Brown/Black
 Midst Table - Black/Black - Ø12Ocm/47.24in
 Midst Table - Black/Black - Ø16Ocm/63in
 Midst Table - D. Oiled Oak/Black - Ø12Ocm/47.24in
 Midst Table - D. Oiled Oak/D. Red - Ø12Ocm/47in
 Midst Table - D. Oiled Oak/D. Red - Ø16Ocm/63in
 Midst Table - D. Oiled Oak/Grey - Ø12Ocm/47.24in
 Midst Table - D. Oiled Oak/Grey - Ø16Ocm/63in
 Midst Table - D. Red/D. Red - Ø12Ocm/47.24in
 Midst Table - D. Red/D. Red - Ø16Ocm/63in
 Midst Table - Solid Oak/Black - Ø12Ocm/47.24in
 Midst Table - Solid Oak/Black - Ø16Ocm/63in
 Midst Table - Solid Oak/D. Red - Ø12Ocm/47.24in
 Midst Table - Solid Oak/D. Red - Ø16Ocm/63in
 Midst Table - Solid Oak/Grey - Ø12Ocm/47.24in
 Midst Table - Solid Oak/Grey - Ø16Ocm/63in
 Mini Stacked - Grey - Large - 2.0
 Mini Stacked - Grey - Medium - 2.0
 Mini Stacked - Grey - Small - 2.0
 Mini Stacked - Midnight Blue - Large DISC W OOS
 Mini Stacked - Midnight Blue - Small DISC WHEN OOS
 Mini Stacked - Midnight Blue Medium DISC WHEN OOS
 Mini Stacked - White - Large - 2.0
 Mini Stacked - White - Medium - 2.0
 Mini Stacked - White - Small - 2.0
 Mini Stacked Clip set - Dusty Green 5 pcs - 2.0
 Mini Stacked Clip Set - Grey - 5 pcs - 2.0
 Mini Stacked Clip Set - Grey - 5 pcs - 2.0-DISC.OOS
 Mini Stacked Clip Set - MTBL - 5 pcs DISC WHEN OOS
 Mini Stacked Clip set - White 5 pcs. - 2.0
 Mini Stacked OakMedium -W/Light Grey back DISC W O
 Nerd Bar - H65 - Midnight Blue (WL)
 Nerd Bar - H65 - Sand Yellow (WL)
 Nerd Bar - H65 - T. Rose w. Steel foot protect(WL)
 Nerd Bar - H65 -Black (WL)
 Nerd Bar - H65 -Black w. Steel foot protect (WL)
 Nerd Bar - H65 -Green (WL)
 Nerd Bar - H65 -Green w. Steel foot protect (WL)
 Nerd Bar - H65 -Grey (WL)
 Nerd Bar - H65 -Grey w. Steel foot protect (WL)
 Nerd Bar - H65 -Tan Rose (WL)
 Nerd Bar - H75 - Midnight Blue (WL)
 Nerd Bar - H75 - Sand Yellow (WL)
 Nerd Bar - H75 - T. Rose w. Steel foot protect(WL)
 Nerd Bar - H75 - White (WL)
 Nerd Bar - H75 -Black (WL)
 Nerd Bar - H75 -Black w. Steel foot protect (WL)
 Nerd Bar - H75 -Green (WL)
 Nerd Bar - H75 -Green w. Steel foot protect (WL)
 Nerd Bar - H75 -Grey (WL)
 Nerd Bar - H75 -Grey w. Steel foot protect (WL)
 Nerd Bar - H75 -Tan Rose (WL)
 Nerd Bar-H65-Midnight Blue Steel foot protect (WL)
 Nerd Bar-H65-Sand Yellow w. Steel foot protect(WL)
 Nerd Bar-H75-Midnight Blue Steel foot protect (WL)
 Nerd Bar-H75-Sand Yellow w. Steel foot protect(WL)
 Nerd Chair - Black (WL)
 Nerd Chair - Green (WL)
 Nerd Chair - Grey (WL)
 Nerd Chair - Midnight Blue (WL)
 Nerd Chair - Sand Yellow (WL)
 Nerd Chair - Tan Rose (WL)
 Nerd Chair - White (WL)
 OOS ORDER I578O Stacked Clip set White 5 pcs. 2.0
 Oslo - 3 Seater - RAL 7026/Steelcut I8O
 Oslo - S.Trio - 3 Seater - Dark Grey_966
 Oslo - Vidar - 2 Seater - Navy Blue_554
 Oslo - Vidar - 3 Seater - Navy Blue_554

COLOR CODES

Formica FIO4O Alpino
 Formica FIO4O Alpino
 FENIX NTM O72O Nero Lngo
 FENIX NTM O72O Nero Lngo
 Formica FIO4O Alpino
 Formica FIO4O Alpino
 FENIX NTM O72O Nero Lngo
 FENIX NTM O72O Nero Lngo
 Formica FIO4O Alpino
 FENIX NTM O72O Nero Lngo
 Formica FIO4O Alpino
 FENIX NTM O72O Nero Lngo
 SEAT/BACK: Black (RAL 9005), FRAME: Black (RAL 9005)

SEAT/BACK: OAK, FRAME: Black (RAL 9005)
 SEAT/BACK: Oak, FRAME: Dusty Green (RAL 7033)
 SEAT/BACK: OAK, FRAME: Deep Red (RAL 8015)
 SEAT/BACK: OAK, FRAME: Grey (RAL 7044)
 SEAT/BACK: Black (RAL 9005), FRAME: Black (RAL 9005)

SEAT/BACK: OAK, FRAME: Black (RAL 9005)
 SEAT/BACK: Oak, FRAME: Dusty Green (RAL 7033)
 SEAT/BACK: OAK, FRAME: Deep Red (RAL 8015)
 SEAT/BACK: OAK, FRAME: Grey (RAL 7044)
 SEAT/BACK: Black (RAL 9005), FRAME: Black (RAL 9005)
 SEAT/BACK: OAK, FRAME: Black (RAL 9005)
 SEAT/BACK: Oak, FRAME: Dusty Green (RAL 7033)
 SEAT/BACK: OAK, FRAME: Deep Red (RAL 8015)
 SEAT/BACK: OAK, FRAME: Grey (RAL 7044)
 SEAT/BACK: Stained Dark Brown, FRAME: Black (RAL 9005)
 SEAT/BACK: OAK, FRAME: White (RAL 9016)
 SEAT/BACK: Black (RAL 9005), FRAME: Black (RAL 9005)
 SEAT/BACK: OAK, FRAME: Black (RAL 9005)
 SEAT/BACK: OAK, FRAME: Deep Red (RAL 8015)
 SEAT/BACK: Oak, FRAME: Dusty Green (RAL 7033)
 SEAT/BACK: OAK, FRAME: Grey (RAL 7044)
 SEAT/BACK: Stained Dark Brown, FRAME: Black (RAL 9005)
 Forbo - Nero 4023/RAL 9005
 Forbo - Nero 4023/RAL 9005
 Dark Oiled Oak/RAL 9005
 Dark Oiled Oak/RAL 9005
 Dark Oiled Oak/RAL 8017
 Dark Oiled Oak/RAL 8017
 Dark Oiled Oak/RAL 8017
 Dark Oiled Oak/RAL 7044
 Dark Oiled Oak/RAL 7044
 Forbo - Burgundy 4154/RAL 8017
 Forbo - Burgundy 4154/RAL 8017
 Oiled Oak/RAL 9005
 Oiled Oak/RAL 9005
 Oiled Oak/RAL 8017
 Oiled Oak/RAL 8017
 Oiled Oak/RAL 7044
 Oiled Oak/RAL 7044
 Light Grey (NCS 2000-N)
 Light Grey (NCS 2000-N)
 Light Grey (NCS 2000-N)
 Midnight Blue (NCS S 8010-R90B)
 Midnight Blue (NCS S 8010-R90B)
 Midnight Blue (NCS S 8010-R90B)
 RAL 9016
 RAL 9016
 RAL 9016
 Dusty Green (Pantone 5625 C)
 Light Grey (NCS S 2000-N)
 Grey (NCS S 5502-B)
 Midnight Blue (NCS S 8010-R90B)
 RAL 9016
 Oak/Light Grey (NCS 2000-N)
 Midnight Blue (RAL 5004)
 Sand Yellow (RAL 1002)
 Tan Rose (NCS 2030-Y8OR)
 Black (RAL 9017)
 Black (RAL 9017)
 Green (NCS S 6020-G)
 Green (NCS S 6020-G)
 Grey (RAL 7040)
 Grey (RAL 7040)
 Tan Rose (NCS 2030-Y8OR)
 Midnight Blue (RAL 5004)
 Sand Yellow (RAL 1002)
 Midnight Blue (RAL 5004)
 Sand Yellow (RAL 1002)
 Black (RAL 9017)
 Green (NCS S 6020-G)
 Grey (RAL 7040)
 Grey (RAL 7040)
 Tan Rose (NCS 2030-Y8OR)
 Midnight Blue (RAL 5004)
 Sand Yellow (RAL 1002)
 Tan Rose (NCS 2030-Y8OR)
 White (RAL 9016)
 RAL 9016
 RAL 9016
 SEAT: Steelcut I8O / BASE: Dark Grey (RAL 7026)
 SEAT: Steelcut Trio 966 / BASE: Dark Grey (RAL 7026)
 SEAT: Vidar 554 / BASE: Navy Blue (RAL 5004)
 SEAT: Vidar 554 / BASE: Navy Blue (RAL 5004)

NEAREST MATCH

RAL9010
 RAL9010
 NCS S 8500-N, RAL DESIGN/OOO 25 OO
 NCS S 8500-N, RAL DESIGN/OOO 25 OO
 RAL 9010
 RAL 9010
 NCS S 8500-N, RAL DESIGN/OOO 25 OO
 NCS S 8500-N, RAL DESIGN/OOO 25 OO
 RAL 9010
 NCS S 8500-N, RAL DESIGN/OOO 25 OO
 NCS S 8500-N, RAL DESIGN/OOO 25 OO
 RAL 9010
 NCS S 8500-N, RAL DESIGN/OOO 25 OO
 BACK: NCS S 9000-N, Pantone 419C, FRAME: NCS S 9000-N, Pantone 419C
 FRAME: NCS S 9000-N, Pantone 419C
 FRAME: NCS S 5005-G5OY, Pantone 416 C
 FRAME: NCS S 6020-Y8OR
 -
 BACK: NCS S 9000-N, Pantone 419C, FRAME: NCS S 9000-N, Pantone 419C
 FRAME: NCS S 9000-N, Pantone 419C
 FRAME: NCS S 5005-G5OY, Pantone 416 C
 FRAME: NCS S 6020-Y8OR
 -
 FRAME: NCS S 9000-N, Pantone 419C
 FRAME: NCS S 9000-N, Pantone 419C
 FRAME: NCS S 5005-G5OY, Pantone 416 C
 FRAME: NCS S 6020-Y8OR
 -
 -
 FRAME: NCS S 0300-N
 FRAME: NCS S 9000-N, Pantone 419C
 FRAME: NCS S 9000-N, Pantone 419C
 FRAME: NCS S 5005-G5OY, Pantone 416 C
 FRAME: NCS S 6020-Y8OR
 -
 -
 FRAME: NCS S 0300-N
 FRAME: NCS S 9000-N, Pantone 419C
 FRAME: NCS S 9000-N, Pantone 419C
 FRAME: NCS S 5005-G5OY, Pantone 416 C
 FRAME: NCS S 6020-Y8OR
 -
 -
 FRAME: NCS S 9000-N, Pantone 419C
 Base Color: NCS S 9000-N, Pantone 419 C
 Base Color: NCS S 9000-N, Pantone 419 C
 Base Color: NCS S 9000-N, Pantone 419 C
 Base Color: NCS S 9000-N, Pantone 419 C
 Base Color: NCS S 8010-Y9OR
 Base Color: NCS S 8010-Y9OR
 Base Color: NCS S 2502-Y, Pantone 413 C
 Base Color: NCS S 2502-Y, Pantone 413 C
 Base Color: NCS S 8010-Y9OR
 Base Color: NCS S 8010-Y9OR
 Base Color: NCS S 9000-N, Pantone 419 C
 Base Color: NCS S 9000-N, Pantone 419 C
 Base Color: NCS S 8010-Y9OR
 Base Color: NCS S 8010-Y9OR
 Base Color: NCS S 2502-Y, Pantone 413 C
 Base Color: NCS S 2502-Y, Pantone 413 C
 RAL 7047, Pantone 42OC
 RAL 7047, Pantone 42OC
 RAL 7047, Pantone 42OC
 -
 -
 -
 -
 NCS S 0300-N
 NCS S 0300-N
 NCS S 0300-N
 NCS S5010-GIOYY, RAL Design 150 50 10
 RAL 7047, Pantone 42OC
 -
 -
 -
 NCS S 0300-N
 NCS S 3502-B, RAL Design 000 70 00
 NCS S 8505-R8OB, Pantone 532 C
 NCS S 2030-Y1OR, Pantone 7508 C
 Pantone 7606 C, RAL Design 040 70 30
 RAL Design 000 20 00
 RAL Design 000 20 00
 RAL Design 170 40 15
 RAL Design 170 40 15
 NCS 4005-R8OB, Pantone Cool Grey 7C
 NCS 4005-R8OB, Pantone Cool Grey 7C
 Pantone 7606 C, RAL Design 040 70 30
 NCS S 8505-R8OB, Pantone 532 C
 NCS S 2030-Y1OR, Pantone 7508 C
 NCS S 8505-R8OB, Pantone 532 C
 NCS S 2030-Y1OR, Pantone 7508 C
 Pantone 426 C, RAL Design 000 20 00
 RAL Design 170 40 15
 NCS S 4005-R8OB, Pantone Cool Grey 7C
 NCS S 8505-R8OB, Pantone 532 C
 NCS S 2030-Y1OR, Pantone 7508 C
 Pantone 7606 C, RAL Design 040 70 30
 NCS S 0502-G5OY, RAL Design I10 96 02
 NCS S 0300-N
 BASE: NCS S 8005-B2OG, Pantone 446 C
 BASE: NCS S 8005-B2OG, Pantone 446 C
 BASE: NCS S 8505-R8OB, Pantone Black 6 C
 BASE: NCS S 8505-R8OB, Pantone Black 6 C

TEXTILE OPTIONS

Striving to work with the best suppliers, the textiles used for Muuto products are by Danish Kvadrat, American KnollTextiles, Swedish Nevotex along with Italian Arve and German Rohleder—all suppliers that have been selected on the basis of their extensive knowledge within the field and state-of-the-art material qualities.

*Upholstered Muuto products that have the Declare Living Building Challenge Compliant certification only have the certification when upholstered with the following Kvadrat textiles: Canvas, Clara, Coda, Divina, Divina MD, Divina Mélange, Fiord, Hallingdal, Remix, Steelcut, Steelcut Trio, Umami and Vidar.

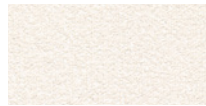

ACCA BY KVADRAT

Designer: Sahco Upholstery.

Composition: 35% viscose, 33% recycled cotton, 25% recycled polyester, 7% recycled polyacrylic.

Durability: 50.000 Martindale / Lightfastness 5-6 (ISO 1-8).

Sustainability: Recycled content. Complies with Greenguard Gold Certification.



101



AEGEAN BY KNOLLTEXTILES

Designer: KnollTextiles

Composition: 35% Acrylic, 15% Cotton, 10% Polyester, 40% Viscose

Durability: 60.000 Wyzenbeek Published / Lightfastness 5 (40hrs)

Sustainability: Clean Air - Silver



1

5 colors available for the Outline Series, Connect Modular Series, Echo Pouf and Fiber Series



Additional colors available for Fiber Series



BALDER BY KVADRAT

Designer: Fanny Aronsen

Composition: 68% new wool, 26% cotton, 6% nylon

Durability: 100.000 Martindale / Lightfastness 6

Sustainability: Natural fibres / Sustainable resource. Complies with Greenguard Gold Certification.



132

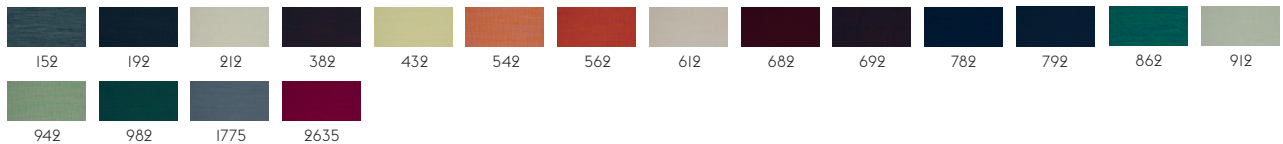

BECK BY MAHARAM

Composition: 78% wool, 22% nylon.

Durability: 100.000 Martindale / Lightfastness AATCC 16.3, 40+ hours.

Sustainability: Complies with Greenguard Gold Certification.



001

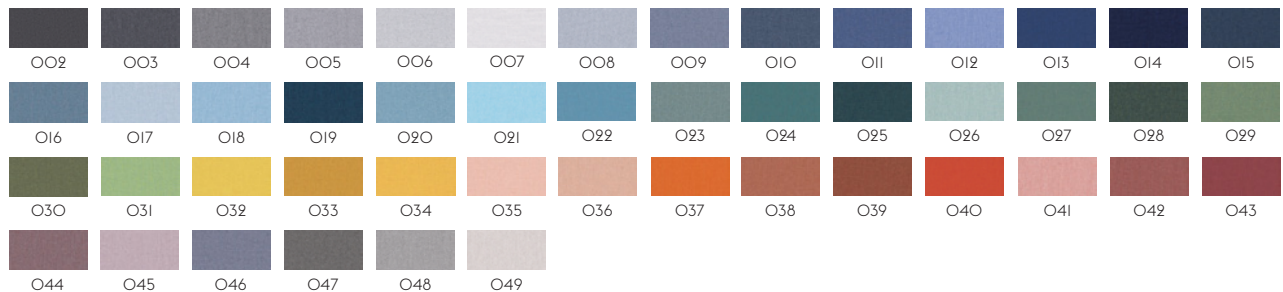

CAMEO BY KNOLLTEXTILES

Designer: KnollTextiles

Composition: 75% Cotton, 25% Viscose.

Durability: 30.000 Wyzenbeek Published / Lightfastness 4 (40hrs)

Sustainability: Greenguard Certification / Clean Air - Silver



1





CANVAS BY KVADRAT

Designer: Giulio Ridolfo.
 Composition: 90% new wool worsted, 10% nylon.
 Durability: 100.000 Martindale / Lightfastness 5-7 (ISO 1-8).
 Sustainability: Complies with both EU ecolabel "The Flower" and Greenguard Gold Certification.

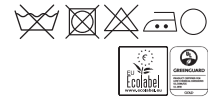

114

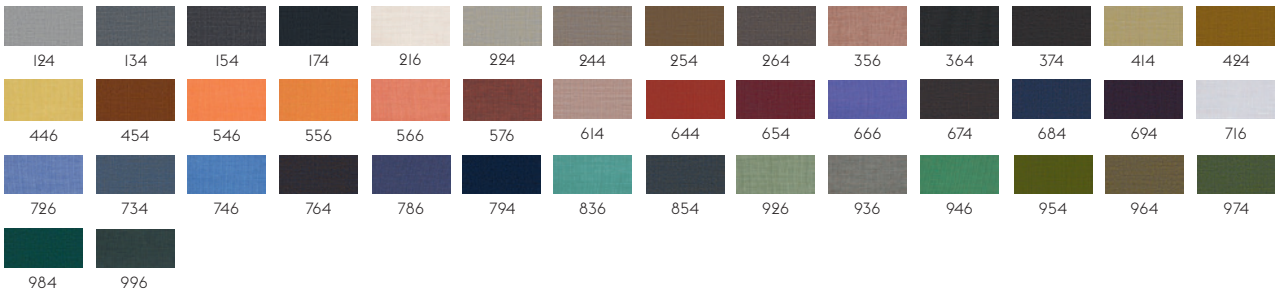

CHAMELEON BY KNOLLTEXTILES

Designer: KnollTextiles
 Composition: 95% Polyurethane, 5% Silicone.
 Durability: 250.000 Wyzenbeek Published
 Sustainability: Clean Air - Gold
 Bleach Cleanable

1

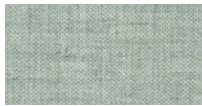

CLARA BY KVADRAT

Designer: Anne Birgitte Hansen.
 Composition: 92% new wool worsted.
 Durability: 80.000 Martindale.
 Sustainability: Complies with both EU ecolabel "The Flower" and Greenguard Gold Certification.

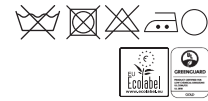

144

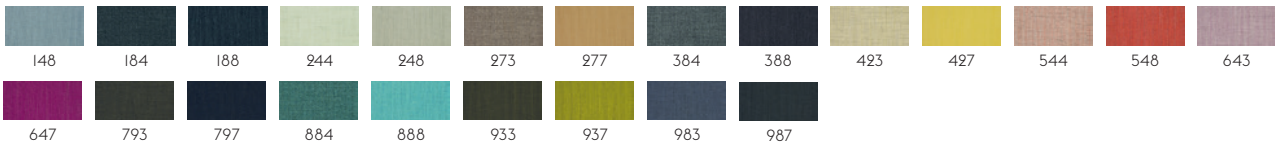

CLAY BY KVADRAT

Designer: Vincent Van Duysen for Kvadrat.
 Composition: 76% Linen, 21% Cotton, 3% Polyester.
 Durability: 45.000 Martindale / Lightfastness 4-6.
 Sustainability: Complies with Greenguard Certification.



1



COLLINE BY KVADRAT

Designer: Frans Dijkmeijer
 Composition: 75% New Wool, Worsted, 17% polyacrylic, 8% Nylon
 Durability: 100.000 Martindale / Lightfastness 7
 Sustainability: Greenguard Gold, HPD, EPD

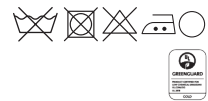

127

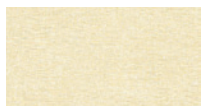
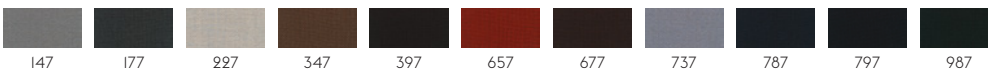

COLOR FIELD BY KNOLLTEXTILES

Designer: KnollTextiles
 Composition: 100% Polyurethane.
 Durability: 250.000 Wyzenbeek Published
 Sustainability: Greenguard Certification / Clean Air - Silver
 Bleach Cleanable

1





DIVINA BY KVADRAT

Designer: Finn Sködt.

Composition: 100% new wool.

Durability: 45.000 Martindale.

Sustainability: Complies with both EU ecolabel "The Flower" and Greenguard Gold Certification.



106

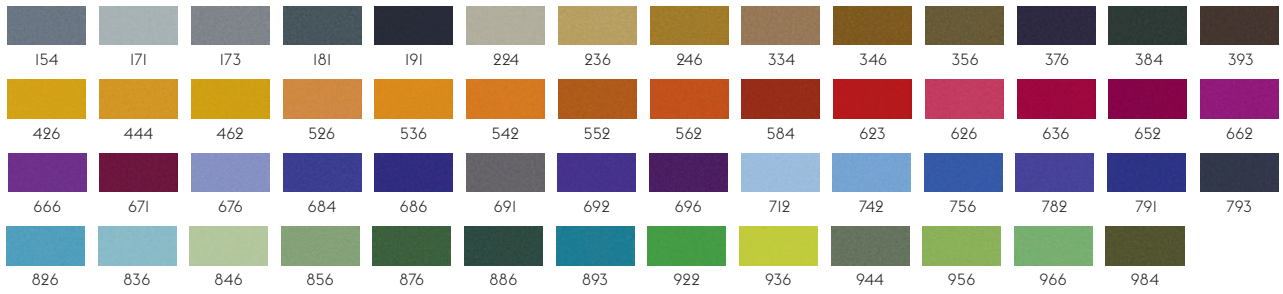

DIVINA MD BY KVADRAT

Designer: Finn Sködt.

Composition: 100% new wool.

Durability: 45.000 Martindale.

Sustainability: Complies with both EU ecolabel "The Flower" and Greenguard Gold Certification.



193

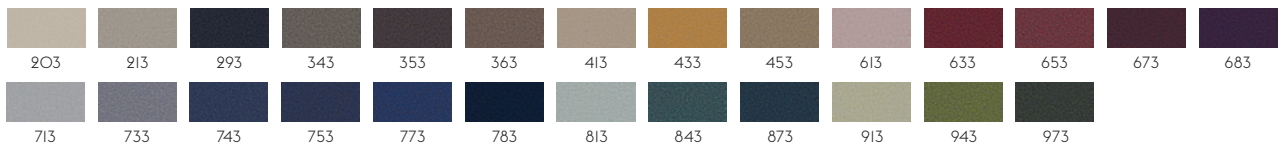

DIVINA MELANGE BY KVADRAT

Designer: Finn Sködt.

Composition: 100% new wool.

Durability: 45.000 Martindale / Lightfastness 6-7.

Sustainability: Complies with both EU ecolabel "The Flower" and Greenguard Gold Certification.

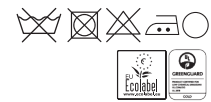

120

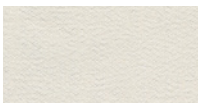
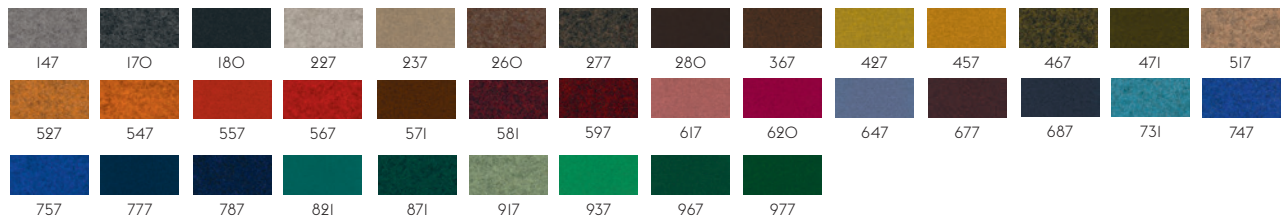

ECRITURE BY KVADRAT

Designer: Sahco.

Composition: 40% polyacrylic, 27% polyester, 18% viscose, 9% linen, 6% cotton.

Durability: 70.000 Martindale / Lightfastness 6.

Sustainability: Complies with Greenguard Gold Certification.



0100

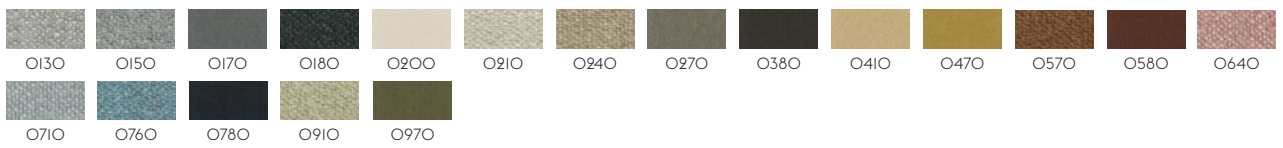

FIORD BY KVADRAT

Designer: Tone Barnung & Louise Sigvardt

Composition: 92% new wool worsted, 8% nylon.

Durability: 60.000 Martindale / Lightfastness 5-6.



101

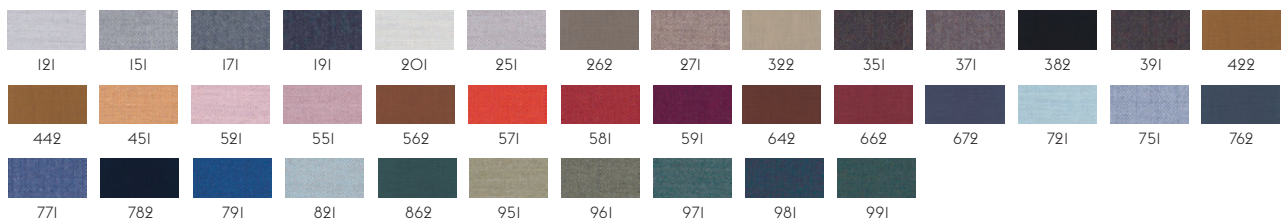



GRAIN BY GABRIEL

Composition: 80% Post-Consumer Recycled Polyester, 20% Polyester
 Durability: 100.000 Martindale / AATCC 16 Light fastness.
 Sustainability: 100% recyclable polyester and meet Möbelfakta requirements



60300

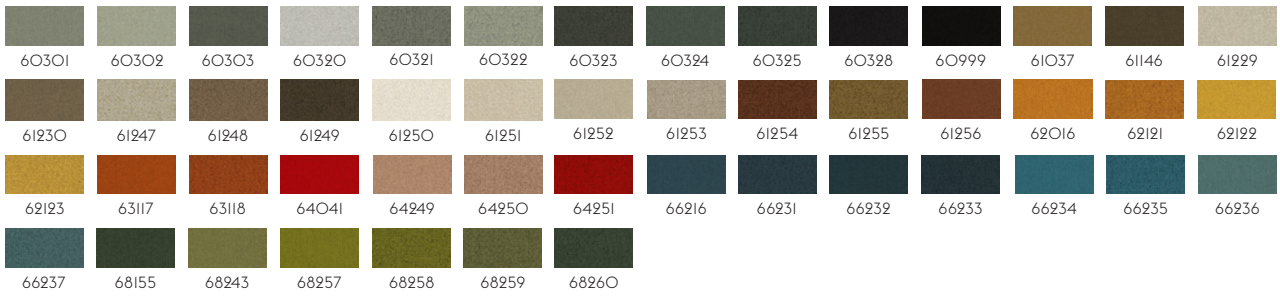

HALLINGDAL 65 BY KVADRAT

Designer: Nanna Ditzel
 Composition: 70% new wool, 30% viscose.
 Durability: 100.000 Martindale / Lightfastness 6-7.
 Sustainability: Complies with both EU ecolabel "The Flower" and Greenguard Gold Certification.

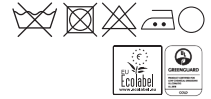

100

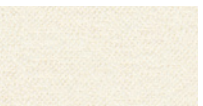
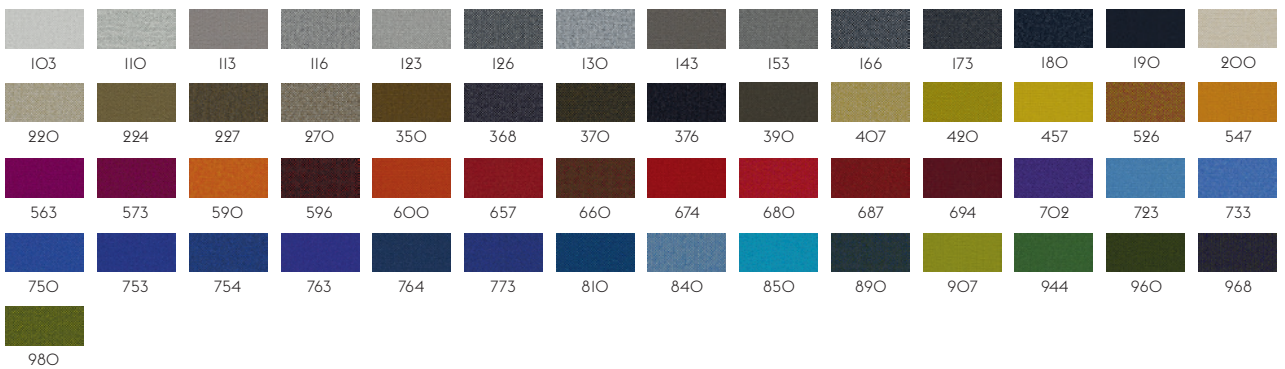

HEARTH BY MAHARAM

Composition: 32% wool, 31% acrylic, 30% cotton, 7% polyester
 Durability: 60.000 Martindale / Lightfastness AATCC 16.3, 40+ hours.
 Sustainability: Complies with Greenguard Gold Certification.



001

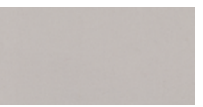

HERO BY KVADRAT

Designer: Patricia Urquiola.
 Composition: 96% new wool, 4% nylon.
 Durability: 45.000 Martindale / Lightfastness 5-6.
 Sustainability: Complies with EU ecolabel "The Flower".

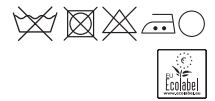

102

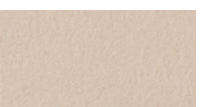
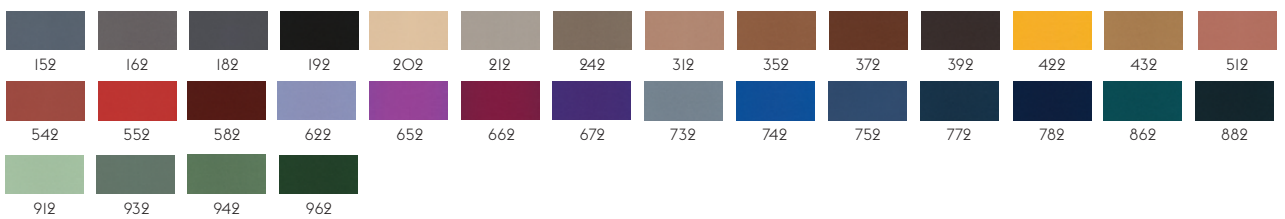

HIGHLAND BY KNOLLTEXTILES

Designer: KnollTextiles
 Composition: 100% Wool
 Durability: 40.000 Martindale 2 / Lightfastness 4 (40hrs 2)
 Sustainability: Greenguard Certification / Clean Air - Silver

1



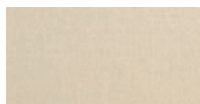

KNOLL HOPSACK BY KNOLLTEXTILES

Designer: KnollTextiles
 Composition: 100% Wool.
 Durability: 40.000 Martindale / Lightfastness 4 (40hrs).
 Sustainability: Greenguard Certification / Clean Air - Silver.



MANNER BY MAHARAM

Composition: 65% Post-Industrial Recycled Polyester, 35% Post-Consumer Recycled Polyester.
 Durability: 300.000 double rubs Wyzenbeek / Lightfastness AATCC I6.3, 40+ hours.
 Sustainability: Complies with Greenguard Gold Certification.



001

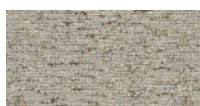
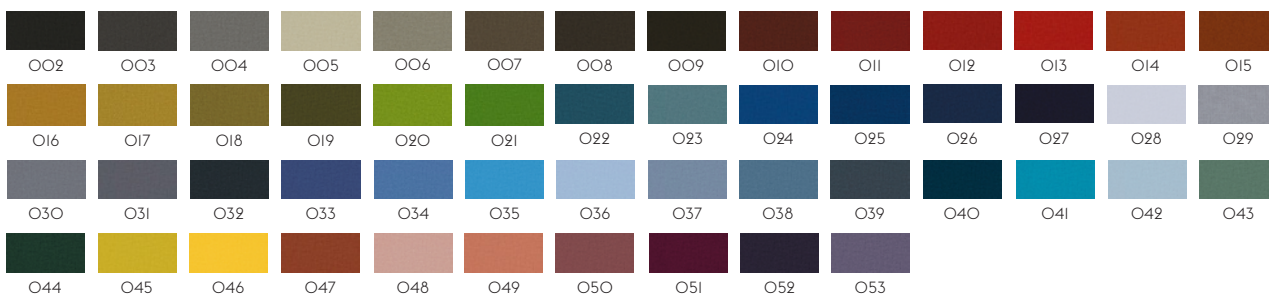

MODERN TWEED BY KNOLLTEXTILES

Designer: KnollTextiles
 Composition: 47% Cotton, 23% Rayon, 14% Polyester, 8% Acrylic, 8% Wool
 Durability: 40.000 Wyzenbeek Published / Lightfastness 4 (40hrs)
 Sustainability: Greenguard Certification / Clean Air - Silver

I

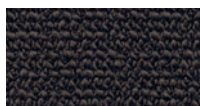
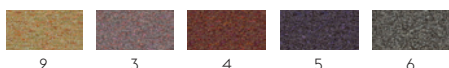

OCEAN BY ROHLEDER

Designer: Rohleder
 Composition: 74% Polyacrylic / 26% Polyester
 Durability: 30.000 Martindale / Lightfastness 5-7 (ISO I-8)



3

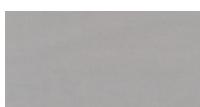

PLANUM BY KVADRAT

Designer: Raw Color.
 Composition: 44% new wool, 42% polyester, 14% nylon.
 Durability: 100.000 Martindale / Lightfastness 5-6 (ISO I-8).
 Sustainability: Complies with Greenguard Certification.



III

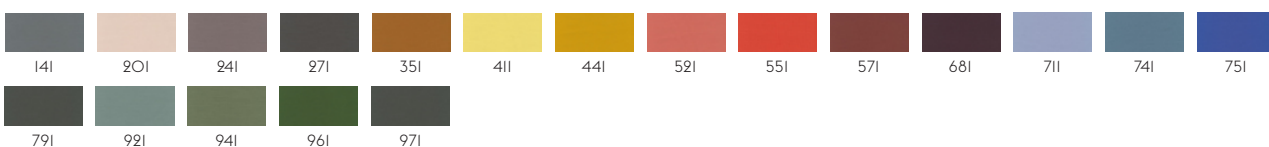

PREMIER SILICONE BY KNOLLTEXTILES

Designer: KnollTextiles
 Composition: 100% SIO Medical Grade Silicone
 Durability: 200.000 Wyzenbeek Published
 Sustainability: Clean Air - Gold
 Bleach Cleanable

I

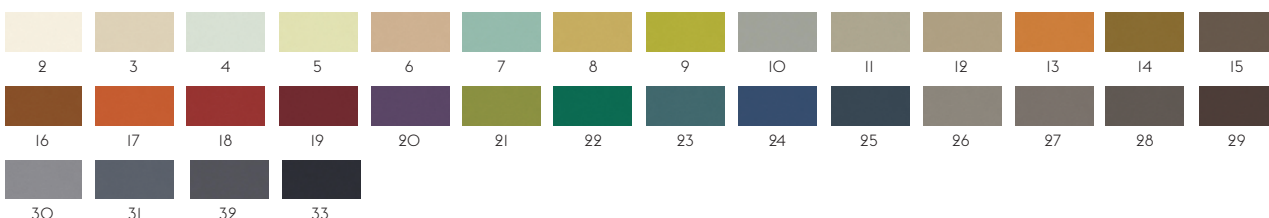

PRAIRIE SILICONE BY KNOLLTEXTILES

Designer: KnollTextiles
 Composition: 100% Non-Phthalate Vinyl
 Durability: 500,000 Wyzenbeek Published / Lightfastness 4 (1000hrs)
 Sustainability: Greenguard Certification / Clean Air - Gold
 Bleach Cleanable

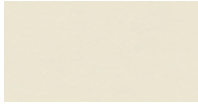

1

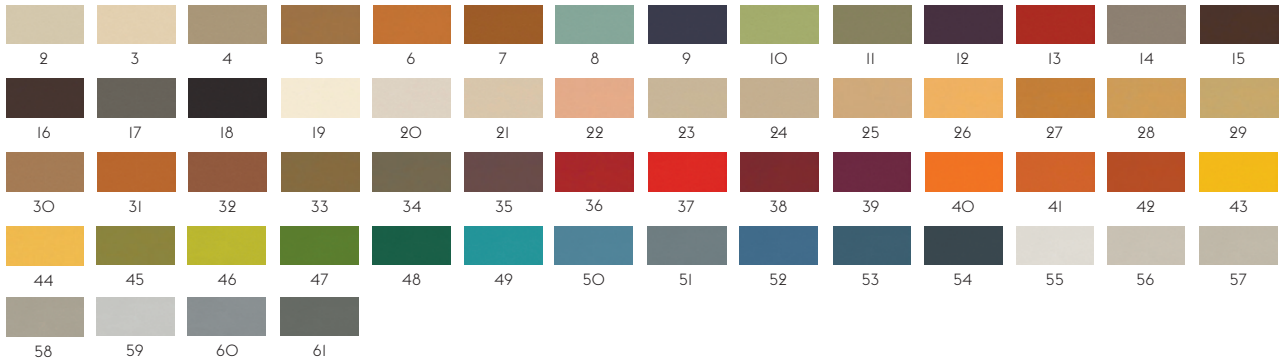

REMIX BY KVADRAT

Designer: Giulio Ridolfo.
 Composition: 90% new wool worsted, 10% nylon.
 Durability: 100,000 Martindale / Lightfastness 5-7 (ISO 1-8)
 Sustainability: Complies with both EU ecolabel "The Flower" and Greenguard Gold Certification.

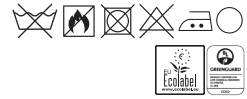

113

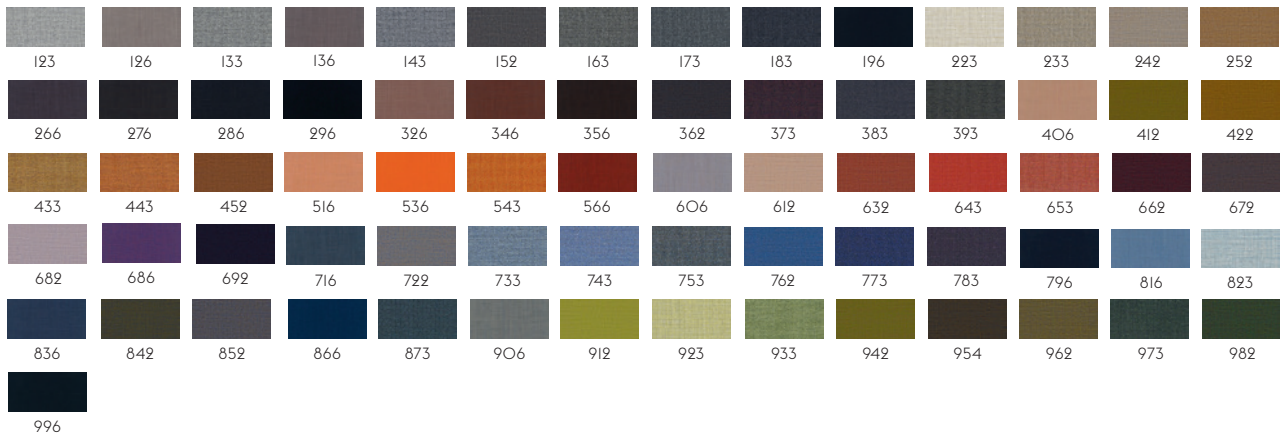

RE-WOOL BY KVADRAT

Designer: Margrethe Odgaard.
 Composition: 45% new wool worsted, 45% recycled wool, 10% nylon.
 Durability: 100,000 Martindale / Lightfastness 5-7 (ISO 1-8).
 Sustainability: Complies with both EU ecolabel "The Flower" and Greenguard Gold Certification.



108

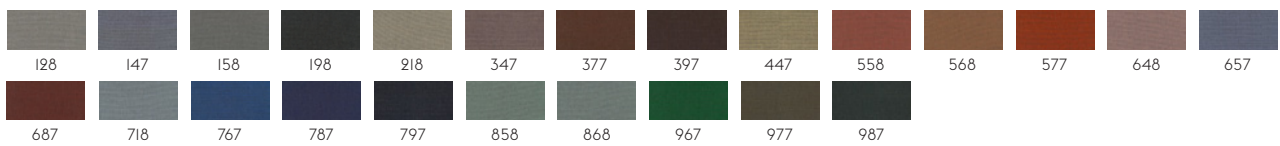

SABI BY KVADRAT

Designer: Louise Sigvardt
 Composition: 65% New Wool, Worsted, 23% Recycled Wool, 12% Nylon
 Durability: 80,000 Martindale / Lightfastness 5-7
 Sustainability: Greenguard Gold, HPD, EPD

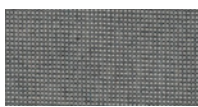
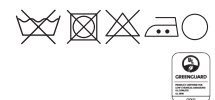

121





STEELCUT BY KVADRAT

Designer: Dijkmeijer & Ridolfo.

Composition: 90% new wool worsted, 10% nylon.

Durability: 80.000 Martindale / Lightfastness 5-7 (ISO 1-8).

Sustainability: Complies with both EU ecolabel "The Flower" and Greenguard Gold Certification.



110

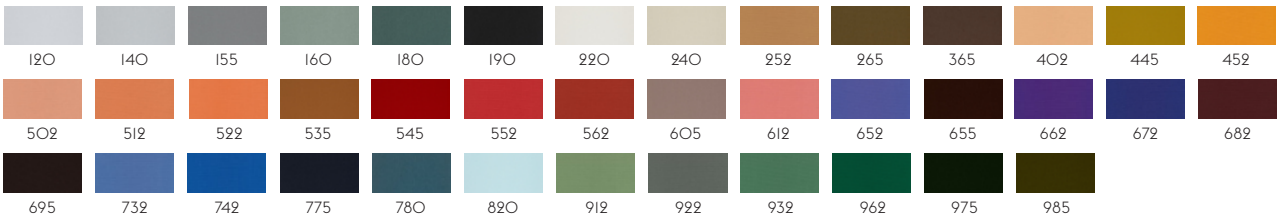

STEELCUT TRIO BY KVADRAT

Designer: Dijkmeijer & Ridolfo

Composition: 90% new wool worsted, 10% nylon.

Durability: 100.000 martindale / Lightfastness 5-7 (ISO 1-8).

Sustainability: Complies with both EU ecolabel "The Flower" and Greenguard Gold Certification.

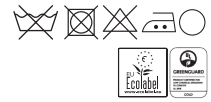

105

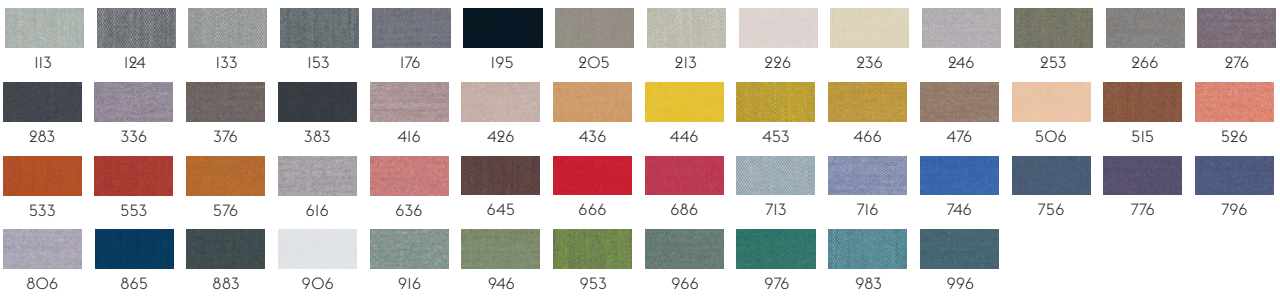

STEELCUT QUARTET BY KVADRAT

Designer: Dijkmeijer & Ridolfo.

Composition: 90% new wool worsted, 10% nylon.

Durability: 100.000 Martindale / Lightfastness 6-7 (ISO 105-B02).

Sustainability: Complies with both EU ecolabel "The Flower" and Greenguard Gold Certification.

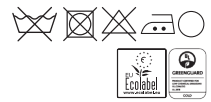

0114

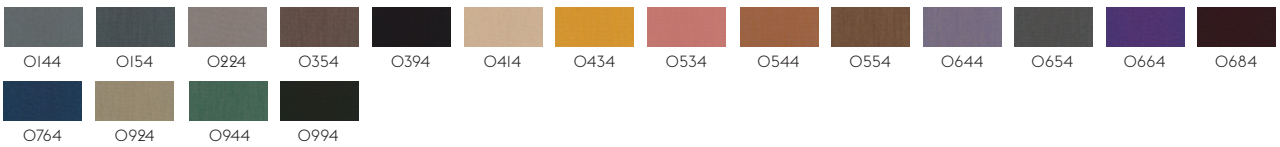

STRETCH APPEAL BY KNOLLTEXTILES

Designer: KnollTextiles

Composition: 78% Wool, 20% Mohair, 2% PU (Elasthan).

Durability: 100.000 Wyzenbeek / Lightfastness 4 (40hrs).

Sustainability: Greenguard Certification / Clean Air - Silver.



2

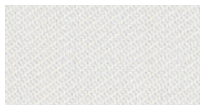

TWILL WEAVE BY KVADRAT

Designer: Jonathan Olivares

Composition: 90% new wool (worsted), 10% nylon

Durability: 60.000 Martindale

Sustainability: Complies with both EU ecolabel "The Flower" and Greenguard Gold Certification.

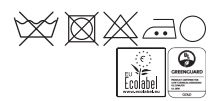

110

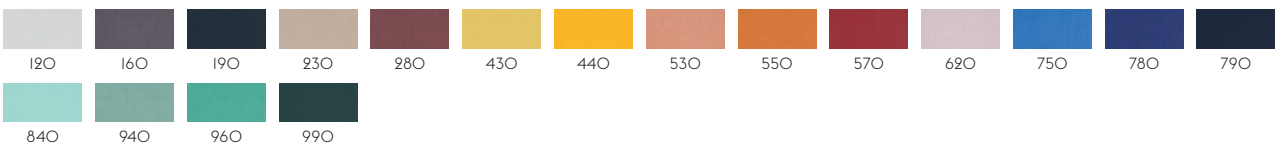



VANCOUVER BY ROSSINI DELLA QUERCIA
 Designer: Gabriella Zecca
 Composition: 52% cotton, 48% acrylic.
 Durability: 40.000 Martindale / Lightfastness 4-5.



4



8 10 12 13 14

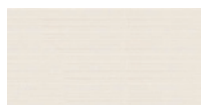

VIBE II BY KNOLLTEXTILES
 Designer: KnollTextiles
 Composition: 100% Polyurethane
 Durability: 100.000 Wyzenbeek Published / Lightfastness 5 (200hrs)
 Sustainability: Clean Air - Gold
 Bleach Cleanable

1

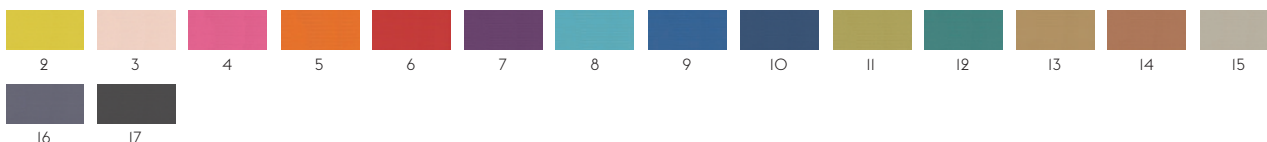

2 3 4 5 6 7 8 9 10 11 12 13 14 15
 16 17

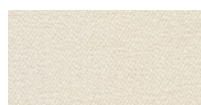

VIDAR BY KVADRAT
 Designer: Raf Simons & Fanny Aronsen for Kvadrat.
 Composition: 94% new wool, 6% nylon.
 Durability: 100.000 Martindale / Lightfastness 6-7.
 Sustainability: Natural fibres / Sustainable resource. Complies with Greenguard Gold Certification.



106

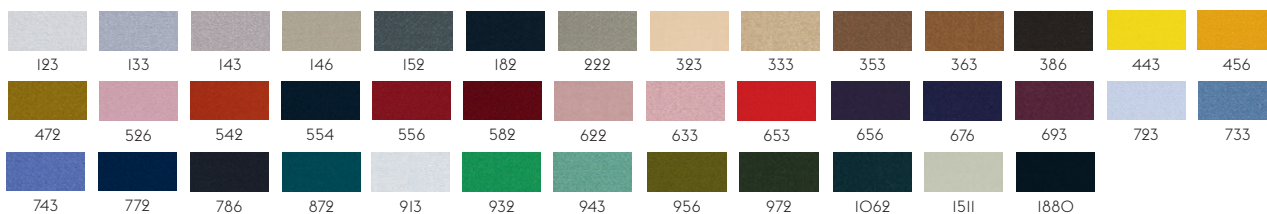

123 133 143 146 152 182 222 323 333 353 363 386 443 456
 472 526 542 554 556 582 622 633 653 656 676 693 723 733
 743 772 786 872 913 932 943 956 972 1062 1511 1880



WOOLY BY NEVOTEX
 Designer: Nevotex
 Composition: 70% wool, 25% polyamide, 5% other fibres.
 Durability: 150.000 Martindale / Lightfastness 6-8.



0091

Wooly is woven in 70% recycled wool, sourced from leftover materials of clothing production and other wool products. One kilo of pure new wool generates 9 kilograms of carbon dioxide when produced while processing one kilo of recycled wool only generates 0.5 kilograms of carbon dioxide. Furthermore, recycled wool has a positive environmental impact due to lessened water consumption and lower energy consumption.



0106 1000 1001 1002 1003 1007 1008 1008 B 1010 1011 1016 1026 1037 1040
 1042 1044 2011 2011 B 2012 B 2014 2016 B 2019 2020 2079 2142 2151 2153 2238
 2240 2252 2255 2256 2269 2270 2272 2278 2279 2287 2288 2301 2302 9145
 9202 9233 9759 9860 9872 228881 380037 840069 842287 849139 22882287

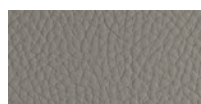

WESTWOOD BY KNOLLTEXTILES
 Designer: KnollTextiles
 Composition: 100% Polyurethane
 Durability: 250.000 Wyzenbeek Published / Lightfastness 5 (200hrs)
 Sustainability: Greenguard Certification / Clean Air - Silver
 Bleach Cleanable

1



2 3 4 5 6 7 8 9 10 11 12

LEATHER OPTIONS

At Muuto, we work with some of the leading leather suppliers to ensure that the leather used for our designs is always of the highest possible standard. Our leather options range from the Refine Leather, a modern and sleek full-grain leather with a soft touch, over Easy Leather, a lightly buffed natural grain leather with a soft and waxy feel along with a matte look, to our Endure Leather, a pliable and extremely durable semi-aniline leather ideal for hard contract environments, and the Volo Leather from Spinneybeck, a chromium-tanned, aniline-dyed leather that has been specially retanned for an enriched and soft feel.



CHAL

ALLURE — ANILINE LEATHER

Soft nubuck aniline leather from European raw hides, known for its exclusive appeal and soft, velvety feel. The leather is dyed through, chrome tanned and produced without the use of PCP and CFC which can be damaging to the environment.



ZINC

EASY LEATHER

Lightly Buffed Natural Grain Leather
Raw material: Designed and processed in Italy. The leather is dyed through, chrome tanned and finishing is with resins and pigments.

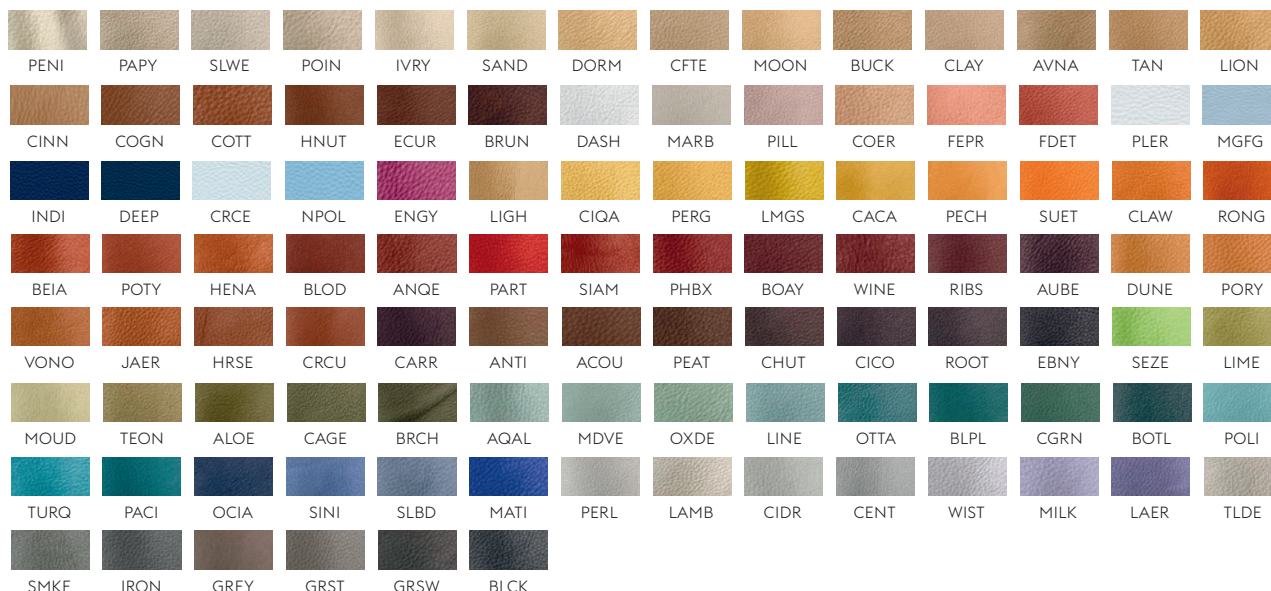

CWIT

ENDURE LEATHER

Semi-aniline leather with high durability, making it ideal for contract environments.
Raw material: Leather from Scandinavian raw hides.
The leather is dyed through a chrome free tanning process. Also available in custom colors in a minimum of 1 hide.





ANTH

GRACE — ANILINE LEATHER

Aniline leather from European raw hides with a natural look and velvety feel, characterized by the natural markings and imperfections that give it a distinct beauty. The leather is dyed through, tanned without chrome and produced without the use of PCP and CFC which can be damaging to the environment.

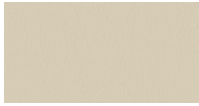

CUST

ILLUSION

Imitation leather from PU (Polyethan) is hard-wearing and easy to maintain which makes it particularly well suited to public spaces, such as restaurants, cafés and lounges. Imitation leather is also a good option for healthcare settings and public spaces where furniture and fittings require frequent and thorough cleaning.



CREM

REFINE LEATHER

Aniline Leather.
Raw material: Grain leather from European raw hides. The leather is dyed through, chrome tanned and produced without the use of PCP and CFC which can be damaging to the environment.

