

CONTRACT PRICE LIST

JANUARY

2025



INTRODUCTION TO THE MUUTO PRICELIST

The Muuto Price List is a complete and comprehensive tool that contains all relevant information to formulate an order. On this page, you will find important product and order information. Please contact Muuto Customer Care or your Muuto Sales Manager if you need further information.

Prices

Recommended retail prices include VAT.
Wholesale prices are stated excl. VAT.
Prices are valid from 02.03.2025.
All prices are subject to change.

Warranty

According to Muuto's general terms of sale and delivery:
10 years on all BIFMA-tested products.
5 years on all other products.

Any alteration or modification to the products (incl. certification through 3rd party) are not covered by the warranty.

Discontinued Products

Products marked with *** will be discontinued when out of stock.

Customers Own Material (COM) & Customers Own Leather (COL)

Price includes the cost to upholster the product using the customer's own material. The cost of the material is not included in the price. All COM/COL requests are subject to testing and approval. Lead times stated in the price list are based on when the factory receives the material.

Test Samples

Muuto offers sourcing of non-standard textiles for upholstered products. Muuto will provide pricing on products in nonstandard textile and confirm if a textile is subject to test upholstery. Prices for test sample products are stated in the pricelist under each product. If textile is provided to Muuto, Muuto will invoice COM price as defined in the price list and potentially the price for the test upholstery. Lead-time of production is confirmed by Muuto after test approval. Confirmed lead times are from reception of textile.

MOQ

Minimum Order Quantity.

MOQ Fee

A MOQ fee is applied when the stated MOQ is not met.

Start Up Fee

The cost to produce a product in a special color and/or non standard size.

Ready-To-Ship

Indicates products that are ready to be shipped from the Muuto warehouse.

Lead Times

Lead times are stated excluding transport from a Muuto warehouse.

Colli

Colli indicates the number of items per item number.

Shipper Colli

Shipper Colli indicates the number of boxes shipped per item.

Test, Labels & Certificates

Our supply chain is constantly evolving; please confirm conformance to the attributes of the given test at the time of specifying your order as information is subject to change.

Contact Information

www.muuto.com/contact

Explore our new perspectives on Scandinavian design across furniture, lighting and accessories. Each design within our collection has its own family page with designer quote, product description, material information, cleaning instructions and more, followed by the pricing options for each individual variant.

INTRODUCTION TO THE PRICE LIST _____	1		
INDEX _____	2		
FURNITURE			
70/70 Table _____	6		
70/70 Table _____	7		
Made-To-Order Options _____	15		
70/70 Outdoor _____	16		
Airy Coffee Table _____	18		
Around Coffee Table _____	23		
Base Table Series _____	27		
Base Table _____	28		
Base Round Table _____	31		
Base High Table _____	32		
Cable Management Solution _____	36		
Made-To-Order Options _____	37		
Compile Shelving System _____	41		
Compile Shelving System Configurations			
Compile Shelving System Shelf _____	50	42	
Compile Shelving System Essential Pack_			
Compile Shelving System Divider Pack_			51
Connect Modular Sofa _____	53	52	
Connect Soft Modular Sofa _____	57		
Connect Soft Modular Sofa Modules _____	60		
Connect Soft Modular Sofa 2-Seater Configurations _____	69		
Connect Soft Modular Sofa 3-Seater Configurations _____	72		
Connect Soft Modular Sofa Corner Configurations _____	75		
Connect Soft Modular Sofa Cushion _____	78		
Made-To-Order Options _____	79		
Couple Coffee Table _____	80		
Cover Chair Series _____	86		
Cover Armchair _____	87		
Cover Side Chair _____	88		
Cover and Visu Chair Transport Trolley _____	89		
Cover Lounge Chair _____	90		
Cover Bar Stool 75 cm / 29.5" _____	91		
Cover Counter Stool 65 cm / 25.6" _____	92		
Made-To-Order Options _____	93		
Doze Lounge Chair & Ottoman _____	95		
Doze Lounge Chair High Back Tube Base _____	96		
Doze Lounge Chair Low Back Tube Base _____	98		
Doze Ottoman Tube Base _____	98	97	
Doze Lounge Chair High Back Swivel Base _____	99		
Doze Lounge Chair Low Back Swivel Base _____	100		
Doze Ottoman Swivel Base _____	101		
Made-To-Order Options _____	102		
Earnest Table _____	103		
Echo Pouf _____	106		
Enfold Sideboard _____	108		
Fiber Chair Series _____	113		
Fiber Armchair Wood Base _____	114		
Fiber Armchair Tube Base _____	115		
Fiber Armchair Swivel Base _____	116		
Fiber Armchair Swivel Base w. Gas Lift and Castors _____	117		
Fiber Side Chair Wood Base _____	118		
Fiber Side Chair Tube Base _____	119		
Fiber Side Chair Swivel Base _____	120		
Fiber Side Chair A-Base _____	121		
Fiber Chair Seat Pad _____	122		
Made-To-Order: Fiber Armchair wood, tube, sled base _____	123		
Made-To-Order: Fiber Armchair Swivel, Swivel w/castors & Gaslift _____	124		
Made-To-Order: Fiber Side Chair wood, tube, sled base _____	125		
Made-To-Order: Fiber Side Chair Swivel, Swivel w/castors & Gaslift _____	126		
Made-To-Order: Fiber Side Chair A-base_			127
Fiber Soft Series _____	128	127	
Fiber Soft Armchair Wood Base _____	129		
Fiber Soft Armchair Tube Base _____	130		
Fiber Soft Armchair Swivel Base _____	131		
Made-To-Order Options: Fiber Soft Armchair _____	132		
Fiber Conference Series _____	135		
Fiber Conference Armchair Wood Base_			136
Fiber Conference Armchair Swivel Base _____	137		
Fiber Conference Armchair Swivel Base w. Gas Lift, Castors and Tilt _____	138		
Made-To-Order Options _____	139		
Fiber Bar & Counter Series _____	142		
Fiber Counter Stool Wood Base - 65 cm / 25.6" _____	143		
Fiber Bar Stool Wood Base - 75 cm / 29.5" _____	145		
Fiber Counter Stool Tube Base - 65 cm / 25.6" _____	147		
Fiber Bar Stool Tube Base - 75 cm / 29.5" _			149
Made-To-Order: Fiber Stools _____	151		
Fiber Lounge Series _____	153		
Fiber Lounge Armchair Wood Base _____	154		
Fiber Lounge Armchair Tube Base _____	155		
Fiber Lounge Chair Wood Base _____	156		
Fiber Lounge Chair Tube Base _____	157		
Fiber Lounge Chair Seat Pad _____	158		
Made-To-Order: Fiber Lounge _____	159		
Fiber Outdoor Series _____	161		
Fiber Outdoor Armchair _____	162		
Fiber Outdoor Side Chair _____	163		
Five Pouf _____	164		
Flow Series _____	166		
Flow Trolley _____	167		
Flow Coffee Table _____	169		
In Situ Modular Sofa _____	170		
In Situ Modular Sofa 2-Seater Configurations _____	173		
In Situ Modular Sofa 3-Seater Configurations _____	180		
In Situ Modular Sofa 4-Seater Configurations _____	189		
In Situ Modular Sofa Corner Configurations _____	194		
In Situ Modular Sofa Modules _____	203		
In Situ Modular Sofa Cushion _____	212		
Made-To-Order Options - Individual parts _____	214		
Linear Steel Series _____	215		
Linear Steel Table _____	216		
Linear Steel Bench _____	219		
Linear Steel Side Chair _____	221		
Linear Steel Armchair _____	222		
Linear Steel Café Table _____	223		
Linear Steel Bar Stool 75 cm / 29.5" _____	229		
Linear Steel Counter Stool 65 cm / 25.6" _			230
Linear Steel Lounge Armchair _____	231		
Linear Steel Coffee Table _____	232		
Linear System Series _____	234		
Linear System Table _____	247		
Linear System High Table _____	253		
Linear System Middle Module _____	259		
Linear System End Module _____	262		
Linear System Connecting Legs _____	270		

Linear System Tray	273
Linear System Screen	277
Linear Table Lamp	280
Linear Mounted Lamp	281
Linear Pendant Lamp	283
Linear System Power Configuration	285
Linear System Cable Tray	286
Linear System Table Power Outlet	287
Made-To-Order Options: Linear System Screens	288
Linear Wood Series	289
Linear Wood Table	290
Linear Wood Bench	293
Loft Chair Series	295
Loft Chair	296
Loft Chair W. Armrest	297
Loft Counter Stool 65 cm / 25.6"	298
Loft Bar Stool 75 cm / 29.5"	299
Made-To-Order Options	300
Midst Table	301
Midst Table	302
Midst Table w. Power cut-out	305
Midst Conference Table	308
Midst Conference Table w. Power cut-out	
Mini Stacked Storage System	317
Nerd Chair Series	322
Nerd Chair	323
Nerd Counter Stool 65 cm / 25.6"	324
Nerd Bar stool 75 cm / 29.5"	325
Oslo Chair Series	328
Oslo Counter Stool 65 cm / 25.6"	329
Oslo Bar Stool 75 cm / 29.5"	330
Made-To-Order Options: Oslo Chairs & Stools	331
Oslo Lounge Series	332
Oslo Lounge Chair Swivel Base	333
Oslo Lounge Chair Tube Base	334
Made-To-Order Options: Oslo Lounge	
Oslo Sofa Series	336
Oslo Sofa 2-Seater	337
Oslo Sofa 3-Seater	338
Made-To-Order Options	339
Outline Sofa Series	340
Outline Sofa 2-Seater	342
Outline Sofa 3-Seater	344
Outline Chair	346
Outline Daybed	348
Outline Daybed Cushion	349
Made-To-Order Options: Outline Series	
Made-To-Order Options: Outline Studio Series	350
Outline Highback Sofa Series	352
Outline Highback Sofa Series	354
Outline Highback Sofa 100 1-Seater	357
Outline Highback Sofa 100 2-Seater	359
Outline Highback Work 100 1-Seater	361
Made-To-Order Options: Outline Highback Series	365
Power Outlet	371
Reflect Sidebord	373
Relate Side Table	376
Rest Sofa Series	379
Rest Sofa 3-Seater	380
Made-To-Order Options	381
Settle Series	382
Settle Lounge Chair	383
Settle Sofa 2-Seater	384
Settle Sofa 3-Seater	385
Soft Table Series	386
Soft Side Table	387
Soft Coffee Table	393
Soft Café Table	396
Soft Table	402
Stacked Storage System	405
Stacked Storage System Open Modules	
Stacked Storage System Modules w. Backboard	409
Stacked Storage System Modules w. Door	415
Stacked Storage System Plinth	417
Stacked Storage System Podium w. Tube Base	419
Stacked Storage System Insert	421
Stacked Storage System Shelf	422
Stacked Storage System Top Plate	423
Stacked Storage System Clips	425
Stacked Storage System Acoustic Panel	
Stacked Storage System Seat Cushion	426
Stacked Storage System Bedside Table	429
Stacked Storage System Bookcase	431
Stacked Storage System Hallway Storage	433
Stacked Storage System Office Storage	441
Stacked Storage System Sideboard	445
Stacked Storage System Podium	455
Still Café Table	456
Visu Chair Series	466
Visu Chair Wood Base	467
Visu Chair Tube Base	468
Visu Chair Sled Base	469
Visu Lounge Chair Wood Base	470
Visu Counter Stool Wood Base - 65 cm / 25.6"	471
Visu Bar Stool Wood Base - 75 cm / 29.5"	
Cover and Visu Chair Transport Trolley	472
Made-To-Order Options	473
Made-To-Order Options	474
Workshop Series	478
Workshop Chair	479
Workshop Table	480
Workshop Coffee Table	483
Workshop Bench	485
Wrap Lounge Chair	486
Wrap Lounge Chair	487
Made-To-Order Options: Wrap Lounge Chair	488
LIGHTING	
Ambit Lamp Series	490
Ambit Pendant Lamp	491
Ambit Rail Lamp	495
Ambit Wall Lamp	496
Beam Table Lamp	497
Control Table Lamp	500
Dedicate Lamp Series	502
Dedicate Table Lamp	503
Dedicate Wall Lamp	512
E27 Pendant Lamp	515
Fluid Pendant Lamp	518
Grain Pendant Lamp	521
Leaf Lamp Series	523
Leaf Table Lamp	524
Leaf Floor Lamp	525
Linear Lamp Series	526
Linear Table Lamp	527
Linear Pendant Lamp	528
Linear Mounted Lamp	530
Post Lamp Series	532
Post Wall Lamp	533
Post Floor Lamp	534
Post Table Lamp	535
Pull Floor Lamp	536
Rime Lamp Series	538
Set Table Lamp	542
Strand Lamp Series	544
Strand Pendant Lamp	545
Strand Table Lamp	551
Tip Lamp Series	552
Tip Table Lamp	553
Tip Wall Lamp	554
Two-Layer Pendant Lamp	555
Under The Bell Pendant Lamp	557
Unfold Pendant Lamp	560
ACCESSORIES	
Ample Throw	564
Arced Mirror	566
Arrange Desktop Series	569
Attach Coat Hook	575
Avail Coat Rack	577
Coil Coat Rack	579
Compile Bookend	582
Corky Series	584
Corky Glasses Set of 4	585
Corky Carafe	586
Dots Series	587
Dots Wood	588
Dots Metal	596
Dots Ceramic	600
Folded Shelves	602
Folded Shelves	603
Folded Platform Shelf	607
Framed Mirror	608
Groove Trivet	611
Kink Vase	613
Layer Cushion	616
Mere Bowl	619
Mingle Cushion	622
Pebble Rug	625
Platform Tray	628
Ply Rug	630
Ply Rug	631

Ply Rug / Recycled Polyester	639	Rhythm Throw	655	Wave Tray	679
Raise Series	643	Ridge Series	657	COLOR CODE INDEX	681
Raise Carafe	644	Ridge Vase	658	UPHOLSTERY OVERVIEW	695
Raise Glasses Set of 2	645	Ridge Planter	661		
Reduce Paper Bin	646	Silent Vase	664		
Relevo Rug	648	Sketch Toolbox	668		
Restore Series	651	Story Pinboard	670		
Restore Basket	652	Tub Jug	672		
Restore Tray	653	Twine Cushion	674		
Restore Round Basket	654	Varjo Rug	676		

FURNITURE

70/70 TABLE

FOR MORE INFORMATION,
EXPLORE BELOW

- ↗ [Product Fact Sheet](#)
- ↗ [Images](#)
- ↗ [Architect Files](#)
- ↗ [Assembly Instructions](#)
- ↗ [Product Declaration](#)

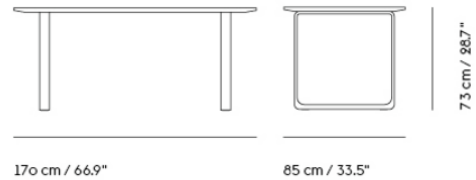

Shipper Colli	2
Gross Weight (kg)	46.31
Net Weight (kg)	39.6
Base color options	Anthracite Black, Grey, Sand or White
Warranty Period	10 years

Pattern No.	Color	Contract Price	Lead Time
Ready-To-Ship US Warehouse			
M7070T6734L-BLCK-WHIT	White Laminate/Plywood/Anthracite Black	USD 2,256.00	-
M7070T6734L-GREY-WHIT	White Laminate/Plywood/Grey	USD 2,256.00	-
M7070T6734L-SAND-WHIT	White Laminate/Plywood/Sand	USD 2,256.00	-
M7070T6734L-WHIT-WHIT	White Laminate/Plywood/White	USD 2,256.00	-
M7070T6734V-BLCK-OAK	Oak Veneer/Plywood/Anthracite Black	USD 2,571.00	-
M7070T6734V-GREY-OAK	Oak Veneer/Plywood/Grey	USD 2,571.00	-
M7070T6734V-SAND-OAK	Oak Veneer/Plywood/Sand	USD 2,571.00	-
M7070T6734V-WHIT-OAK	Oak Veneer/Plywood/White	USD 2,571.00	-
M7070T6734O-BLCK-BLCK	Black Linoleum/Plywood/Anthracite Black	USD 2,256.00	-
M7070T6734O-GREY-BLCK	Black Linoleum/Plywood/Grey	USD 2,256.00	-
M7070T6734O-SAND-BLCK	Black Linoleum/Plywood/Sand	USD 2,256.00	-
M7070T6734O-WHIT-BLCK	Black Linoleum/Plywood/White	USD 2,256.00	-
M7070T6734O-SAND-GREY	Grey Linoleum/Plywood/Sand	USD 2,256.00	-
M7070T6734W-BLCK-SOAK	Solid Oak/Anthracite Black	USD 3,306.00	-
M7070T6734W-GREY-SOAK	Solid Oak/Grey	USD 3,306.00	-
M7070T6734W-SAND-SOAK	Solid Oak/Sand	USD 3,306.00	-
M7070T6734W-BLCK-SMOAK	Solid Smoked Oak/Anthracite Black	USD 3,516.00	-
M7070T6734W-GREY-SMOAK	Solid Smoked Oak/Grey	USD 3,516.00	-

Pattern No.	Color	Contract Price	Lead Time
M7070T6734W-SAND-SMOAK	Solid Smoked Oak/Sand	USD 3,516.00	-
M7070T6734W-WHIT-SMOAK	Solid Smoked Oak/White	USD 3,516.00	-

Ready-To-Ship EU Warehouse

M7070T6734O-BLCK-GREY	Grey Linoleum/Plywood/Anthracite Black	USD 2,256.00	-
M7070T6734O-GREY-GREY	Grey Linoleum/Plywood/Grey	USD 2,256.00	-
M7070T6734O-WHIT-GREY	Grey Linoleum/Plywood/White	USD 2,256.00	-
M7070T6734W-WHIT-SOAK	Solid Oak/White	USD 3,306.00	-

Extras

MT7070TSCRK-BLCK	Screw Kit for 70/70 Table	USD 23.00	-
------------------	---------------------------	-----------	---

70/70 TABLE / 225 X 90 CM / 88.5 X 35.5"

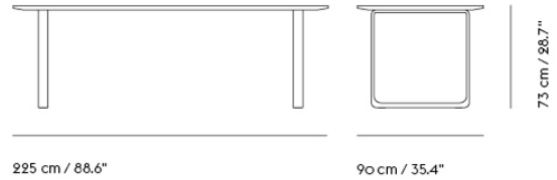
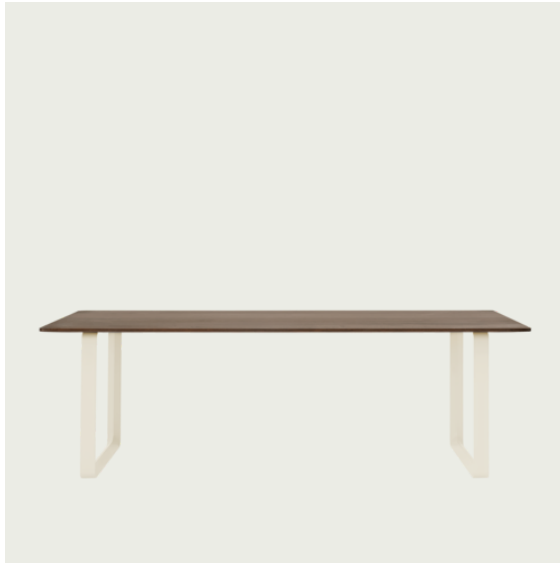

Shipper Colli	2
Gross Weight (kg)	78.8l
Net Weight (kg)	72.1
Base color options	Anthracite Black, Grey, Sand or White
Warranty Period	10 years

Pattern No.	Color	Contract Price	Lead Time
Ready-To-Ship US Warehouse			
M7070T8936L-BLCK-WHIT	White Laminate/Plywood/Anthracite Black	USD 3,040.00	-
M7070T8936L-GREY-WHIT	White Laminate/Plywood/Grey	USD 3,040.00	-
M7070T8936L-SAND-WHIT	White Laminate/Plywood/Sand	USD 3,040.00	-
M7070T8936L-WHIT-WHIT	White Laminate/Plywood/White	USD 3,040.00	-
M7070T8936V-BLCK-OAK	Oak Veneer/Plywood/Anthracite Black	USD 3,306.00	-
M7070T8936V-GREY-OAK	Oak Veneer/Plywood/Grey	USD 3,306.00	-
M7070T8936V-SAND-OAK	Oak Veneer/Plywood/Sand	USD 3,306.00	-
M7070T8936V-WHIT-OAK	Oak Veneer/Plywood/White	USD 3,306.00	-
M7070T8936O-BLCK-BLCK	Black Linoleum/Plywood/Anthracite Black	USD 3,040.00	-
M7070T8936O-GREY-BLCK	Black Linoleum/Plywood/Grey	USD 3,040.00	-
M7070T8936O-SAND-BLCK	Black Linoleum/Plywood/Sand	USD 3,040.00	-
M7070T8936O-WHIT-BLCK	Black Linoleum/Plywood/White	USD 3,040.00	-
M7070T8936O-SAND-GREY	Grey Linoleum/Plywood/Sand	USD 3,040.00	-
M7070T8936W-BLCK-SOAK	Solid Oak/Anthracite Black	USD 4,566.00	-
M7070T8936W-GREY-SOAK	Solid Oak/Grey	USD 4,566.00	-
M7070T8936W-SAND-SOAK	Solid Oak/Sand	USD 4,566.00	-
M7070T8936W-WHIT-SOAK	Solid Oak/White	USD 4,566.00	-
M7070T8936W-BLCK-SMOAK	Solid Smoked Oak/Anthracite Black	USD 4,671.00	-
M7070T8936W-GREY-SMOAK	Solid Smoked Oak/Grey	USD 4,671.00	-

Pattern No.	Color	Contract Price	Lead Time
M7070T8936W-SAND-SMOAK	Solid Smoked Oak/Sand	USD 4,671.00	-
M7070T8936W-WHIT-SMOAK	Solid Smoked Oak/White	USD 4,671.00	-

Ready-To-Ship EU Warehouse

M7070T8936O-BLCK-GREY	Grey Linoleum/Plywood/Anthracite Black	USD 3,040.00	-
M7070T8936O-GREY-GREY	Grey Linoleum/Plywood/Grey	USD 3,040.00	-
M7070T8936O-WHIT-GREY	Grey Linoleum/Plywood/White	USD 3,040.00	-

Extras

MT7070TSCRK-BLCK	Screw Kit for 70/70 Table	USD 23.00	-
------------------	---------------------------	-----------	---

70/70 TABLE / 255 X 108 CM / 100.5 X 42.5"

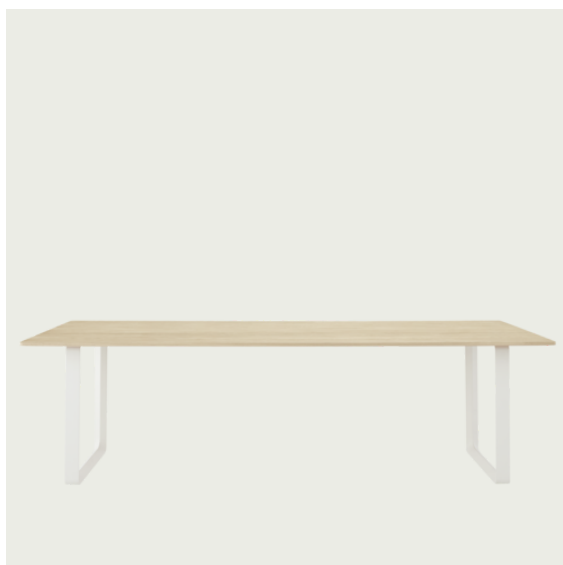

255 cm / 100.4"

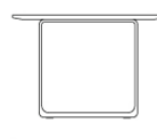

73 cm / 28.7"

108 cm / 42.5"

Shipper Colli	2
Gross Weight (kg)	100.85
Net Weight (kg)	92
Base color options	Anthracite Black, Grey, Sand or White
Warranty Period	10 years

Pattern No.	Color	Contract Price	Lead Time
Ready-To-Ship US Warehouse			
M7070T10143L-BLCK-WHIT	White Laminate/Plywood/Anthracite Black	USD 3,145.00	-
M7070T10143L-GREY-WHIT	White Laminate/Plywood/Grey	USD 3,145.00	-
M7070T10143L-SAND-WHIT	White Laminate/Plywood/Sand	USD 3,145.00	-
M7070T10143L-WHIT-WHIT	White Laminate/Plywood/White	USD 3,145.00	-
M7070T10143V-BLCK-OAK	Oak Veneer/Plywood/Anthracite Black	USD 3,621.00	-
M7070T10143V-GREY-OAK	Oak Veneer/Plywood/Grey	USD 3,621.00	-
M7070T10143V-SAND-OAK	Oak Veneer/Plywood/Sand	USD 3,621.00	-
M7070T10143V-WHIT-OAK	Oak Veneer/Plywood/White	USD 3,621.00	-
M7070T10143O-BLCK-BLCK	Black Linoleum/Plywood/Anthracite Black	USD 3,145.00	-
M7070T10143O-GREY-BLCK	Black Linoleum/Plywood/Grey	USD 3,145.00	-
M7070T10143O-SAND-BLCK	Black Linoleum/Plywood/Sand	USD 3,145.00	-
M7070T10143O-WHIT-BLCK	Black Linoleum/Plywood/White	USD 3,145.00	-
M7070T10143W-BLCK-SOAK	Solid Oak/Anthracite Black	USD 5,770.00	-
M7070T10143W-GREY-SOAK	Solid Oak/Grey	USD 5,770.00	-
M7070T10143W-SAND-SOAK	Solid Oak/Sand	USD 5,770.00	-
M7070T10143W-WHIT-SOAK	Solid Oak/White	USD 5,770.00	-

Pattern No.	Color	Contract Price	Lead Time
M7070T10143W-BLCK-SMOAK	Solid Smoked Oak/Anthracite Black	USD 6,141.00	-
M7070T10143W-GREY-SMOAK	Solid Smoked Oak/Grey	USD 6,141.00	-
M7070T10143W-SAND-SMOAK	Solid Smoked Oak/Sand	USD 6,141.00	-
M7070T10143W-WHIT-SMOAK	Solid Smoked Oak/White	USD 6,141.00	-
Ready-To-Ship EU Warehouse			
M7070T10143O-BLCK-GREY	Grey Linoleum/Plywood/Anthracite Black	USD 3,145.00	-
M7070T10143O-GREY-GREY	Grey Linoleum/Plywood/Grey	USD 3,145.00	-
M7070T10143O-SAND-GREY	Grey Linoleum/Plywood/Sand	USD 3,145.00	-
M7070T10143O-WHIT-GREY	Grey Linoleum/Plywood/White	USD 3,145.00	-
Extras			
MT7070TSCRK-BLCK	Screw Kit for 70/70 Table	USD 23.00	-

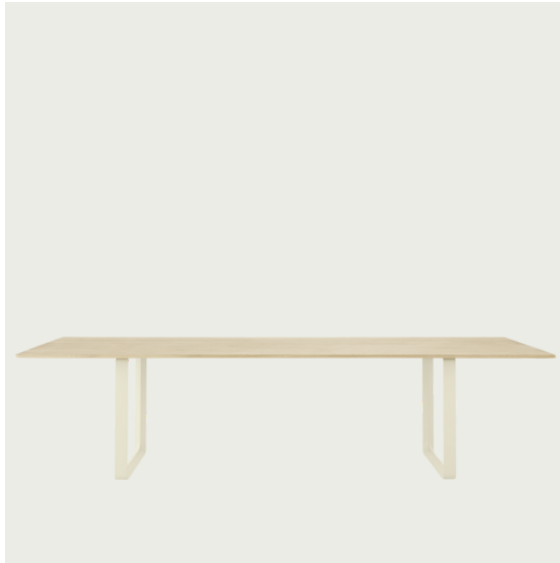

295 cm / 116.1"



73 cm / 28.7"

108 cm / 42.5"

Shipper Colli	2
Gross Weight (kg)	111.65
Net Weight (kg)	102.8
Base color options	Anthracite Black, Grey, Sand or White
Warranty Period	10 years

Pattern No.	Color	Contract Price	Lead Time
Ready-To-Ship US Warehouse			
M7070T11643L-BLCK-WHIT	White Laminate/Plywood/Anthracite Black	USD 3,355.00	-
M7070T11643L-GREY-WHIT	White Laminate/Plywood/Grey	USD 3,355.00	-
M7070T11643L-WHIT-WHIT	White Laminate/Plywood/White	USD 3,355.00	-
M7070T11643V-BLCK-OAK	Oak Veneer/Plywood/Anthracite Black	USD 3,880.00	-
M7070T11643V-GREY-OAK	Oak Veneer/Plywood/Grey	USD 3,880.00	-
M7070T11643V-SAND-OAK	Oak Veneer/Plywood/Sand	USD 3,880.00	-
M7070T11643V-WHIT-OAK	Oak Veneer/Plywood/White	USD 3,880.00	-
M7070T11643O-BLCK-BLCK	Black Linoleum/Plywood/Anthracite Black	USD 3,355.00	-
M7070T11643O-GREY-BLCK	Black Linoleum/Plywood/Grey	USD 3,355.00	-
M7070T11643O-SAND-BLCK	Black Linoleum/Plywood/Sand	USD 3,355.00	-
M7070T11643O-WHIT-BLCK	Black Linoleum/Plywood/White	USD 3,355.00	-
M7070T11643W-BLCK-SOAK	Solid Oak/Anthracite Black	USD 6,351.00	-
M7070T11643W-GREY-SOAK	Solid Oak/Grey	USD 6,351.00	-
M7070T11643W-SAND-SOAK	Solid Oak/Sand	USD 6,351.00	-
M7070T11643W-WHIT-SOAK	Solid Oak/White	USD 6,351.00	-
M7070T11643W-BLCK-SMOAK	Solid Smoked Oak/Anthracite Black	USD 6,715.00	-

Pattern No.	Color	Contract Price	Lead Time
M7070T11643W-GREY-SMOAK	Solid Smoked Oak/Grey	USD 6,715.00	-
M7070T11643W-SAND-SMOAK	Solid Smoked Oak/Sand	USD 6,715.00	-
M7070T11643W-WHIT-SMOAK	Solid Smoked Oak/White	USD 6,715.00	-
Ready-To-Ship EU Warehouse			
M7070T11643L-SAND-WHIT	White Laminate/Plywood/Sand	USD 3,355.00	-
M7070T11643O-BLCK-GREY	Grey Linoleum/Plywood/Anthracite Black	USD 3,355.00	-
M7070T11643O-GREY-GREY	Grey Linoleum/Plywood/Grey	USD 3,355.00	-
M7070T11643O-SAND-GREY	Grey Linoleum/Plywood/Sand	USD 3,355.00	-
M7070T11643O-WHIT-GREY	Grey Linoleum/Plywood/White	USD 3,355.00	-
Extras			
MT7070TSCRK-BLCK	Screw Kit for 70/70 Table	USD 23.00	-



All Variants

Sizes	Pattern No.	Width	Depth	Height	Contract Price					
					Laminate (L)	Linoleum (O)	Oak veneer (V)	Nanolaminate (N)	Solid Oak (W)	Solid Smoked Oak (W)
70/70 Table / 170 X 85 CM / 67 X 33.5"	M-7070T-6734-	67"	34"	28.75"	2,256	2,256	2,571	2,571	3,306	3,516
70/70 Table / 225 X 90 CM / 88.5 X 35.5"	M-7070T-8936-	88.5"	35.5"	28.75"	3,040	3,040	3,306	3,355	4,566	4,671
70/70 Table / 255 X 108 CM / 100.5 X 42.5"	M-7070T-10143-	100.5"	42.5"	28.75"	3,145	3,145	3,621	3,565	5,770	6,141
70/70 Table / 295 X 108 CM / 116 X 42.5"	M-7070T-11643-	116"	42.5"	28.75"	3,355	3,355	3,880	3,831	6,351	6,715

HOW TO CONFIGURE

ORDER CODE EXAMPLE

Specify:

70/70 Table 100.5 x 42.5" with oak veneer table top and black base

- Step 1) Select Size
- Step 2) Select table top material
- Step 3) Select Base color
- Step 4) Select Table top color

Size	255 X 108 CM / 100.5 X 42.5"	M-7070T-10143-
Table top material	Veneer	V
Base color	Black base	BLCK
Table top finish	Oak veneer	OAK
Final Pattern No.	M7070T10143VBLCKOAK	

Table Top Material	Base Color Options	Table Top Finish
L - Laminate O - Linoleum V - Veneer N - Nanolaminate W - Solid Wood	WHIT - White BLCK - Black GREY - Grey SAND - Sand	Laminate WHIT - White Linoleum BLCK - Black GREY - Grey Veneer OAK - Oak Nanolaminate WHIT - White BLCK - Black GREY - Grey Solid Wood SOAK - W1 Solid Oak SMOAK - W2 Solid Smoked Oak

70/70 OUTDOOR TABLE

FOR MORE INFORMATION,
EXPLORE BELOW

- ↗ [Product Fact Sheet](#)
- ↗ [Images](#)
- ↗ [Architect Files](#)
- ↗ [Product Declaration](#)

70/70 OUTDOOR TABLE / 225 X 90 CM / 88.5 X 35.5"

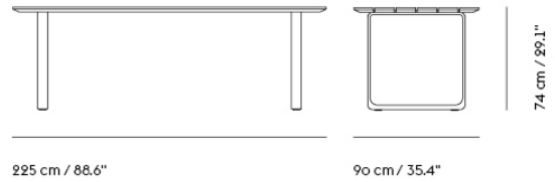

Shipper Colli	2
Gross Weight (kg)	78.8l
Net Weight (kg)	72.l
Base color options	Anthracite Black, Grey
Warranty Period	10 years

Pattern No.	Color	Contract Price	Lead Time
Ready-To-Ship US Warehouse			
M7070TO8936M-BLCK-MHGY	Sapele Mahogany/Anthracite Black	USD 4,041.00	-
M7070TO8936M-GREY-MHGY	Sapele Mahogany/Grey	USD 4,041.00	-
Extras			
MT7070TSCRK-BLCK	Screw Kit for 70/70 Table	USD 23.00	-
MODCV-BLCK	Outdoor Cover for 70/70 Outdoor Table and Linear Steel Table 220 x 90 CM / 86.6 x 35.5"	USD 299.00	-

AIRY COFFEE TABLE

FOR MORE INFORMATION,
EXPLORE BELOW

- ↗ [Product Fact Sheet](#)
- ↗ [Images](#)
- ↗ [Architect Files](#)
- ↗ [Assembly Instructions](#)
- ↗ [Product Declaration](#)

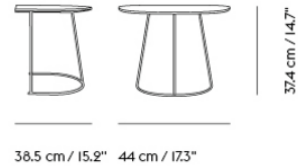

Shipper Colli 2
Gross Weight (kg) 4.514
Net Weight (kg) 3.1
Warranty Period 5 years

Pattern No.	Color	Contract Price	Lead Time
Ready-To-Ship US Warehouse			
MARYCT161715N-BLCK	Black Nanolaminate/Black	USD 331.00	-
MARYCT161715N-GREY	Grey Nanolaminate/Grey	USD 331.00	-
MARYCT161715N-OWHT	Off-White Nanolaminate/Off-White	USD 331.00	-

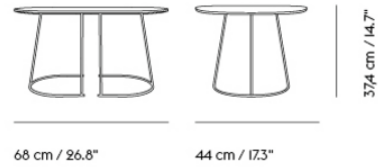

Shipper Colli 2
Gross Weight (kg) 6.262
Net Weight (kg) 4.71
Warranty Period 5 years

Pattern No.	Color	Contract Price	Lead Time
Ready-To-Ship US Warehouse			
MARYCT271715N-BLCK	Black Nanolaminate/Black	USD 530.00	-
MARYCT271715N-GREY	Grey Nanolaminate/Grey	USD 530.00	-
MARYCT271715N-OWHT	Off-White Nanolaminate/Off-White	USD 530.00	-



Shipper Colli 2
Gross Weight (kg) 7.852
Net Weight (kg) 6.21
Warranty Period 5 years

Pattern No.	Color	Contract Price	Lead Time
Ready-To-Ship US Warehouse			
MARYCT352015N-BLCK	Black Nanolaminate/Black	USD 614.00	-
MARYCT352015N-GREY	Grey Nanolaminate/Grey	USD 614.00	-
MARYCT352015N-OWHT	Off-White Nanolaminate/Off-White	USD 614.00	-

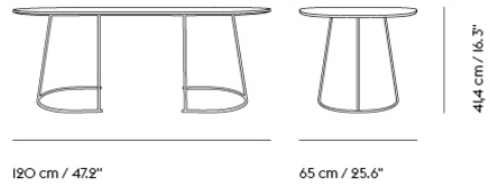

Shipper Colli 2
Gross Weight (kg) 11.646
Net Weight (kg) 9.56
Warranty Period 5 years

Pattern No.	Color	Contract Price	Lead Time
Ready-To-Ship US Warehouse			
MARYCT472616N-BLCK	Black Nanolaminate/Black	USD 797.00	-
MARYCT472616N-GREY	Grey Nanolaminate/Grey	USD 797.00	-
MARYCT472616N-OWHT	Off-White Nanolaminate/Off-White	USD 797.00	-

AROUND COFFEE TABLE

FOR MORE INFORMATION,
EXPLORE BELOW

- ↗ [Product Fact Sheet](#)
- ↗ [Images](#)
- ↗ [Architect Files](#)
- ↗ [Assembly Instructions](#)
- ↗ [Product Declaration](#)

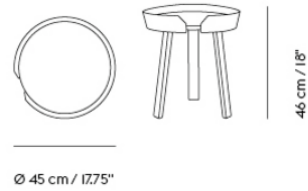
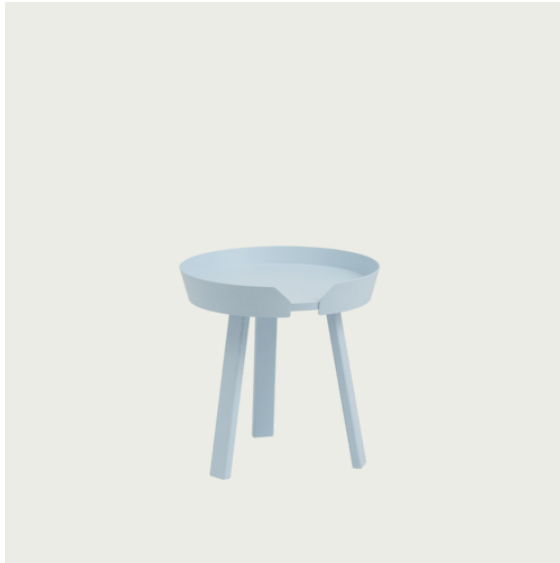

Shipper Colli 1
Gross Weight (kg) 3.82
Net Weight (kg) 2.94
Warranty Period 5 years

Pattern No.	Color	Contract Price	Lead Time
Ready-To-Ship US Warehouse			
MARDCT1818-OAK	Oak	USD 576.00	-
MARDCT1818-ANTH	Anthracite	USD 576.00	-
MARDCT1818-ASH	Ash	USD 576.00	-
MARDCT1818-BLCK	Black	USD 576.00	-
MARDCT1818-DKGN	Dark Green	USD 576.00	-
MARDCT1818-DGRN	Dusty Green	USD 576.00	-
MARDCT1818-GREY	Grey	USD 576.00	-
MARDCT1818-LTBU	Light Blue	USD 576.00	-
MARDCT1818-STDB	Stained Dark Brown	USD 576.00	-
MARDCT1818-TROS	Tan Rose	USD 576.00	-
MARDCT1818-WHIT	White	USD 576.00	-

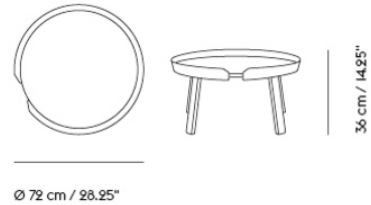

Shipper Colli 1
Gross Weight (kg) 7.06
Net Weight (kg) 5.92
Warranty Period 5 years

Pattern No.	Color	Contract Price	Lead Time
Ready-To-Ship US Warehouse			
MARDCT2814-OAK	Oak	USD 933.00	-
MARDCT2814-ANTH	Anthracite	USD 933.00	-
MARDCT2814-ASH	Ash	USD 933.00	-
MARDCT2814-BLCK	Black	USD 933.00	-
MARDCT2814-DGRN	Dusty Green	USD 933.00	-
MARDCT2814-GREY	Grey	USD 933.00	-
MARDCT2814-STDB	Stained Dark Brown	USD 933.00	-
MARDCT2814-WHIT	White	USD 933.00	-
Ready-To-Ship EU Warehouse			
MARDCT2814-DKGN	Dark Green	USD 933.00	-

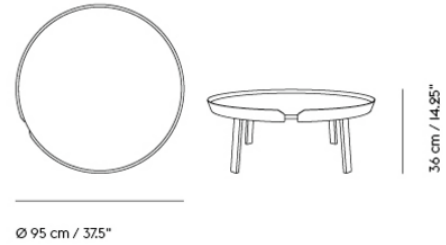

Shipper Colli 1
Gross Weight (kg) 13.06
Net Weight (kg) 10.52
Warranty Period 5 years

Pattern No.	Color	Contract Price	Lead Time
Ready-To-Ship US Warehouse			
MARDCT3814-OAK	Oak	USD 1,206.00	-
MARDCT3814-ANTH	Anthracite	USD 1,206.00	-
MARDCT3814-ASH	Ash	USD 1,206.00	-
MARDCT3814-BLCK	Black	USD 1,206.00	-
MARDCT3814-DGRN	Dusty Green	USD 1,206.00	-
MARDCT3814-GREY	Grey	USD 1,206.00	-
MARDCT3814-STDB	Stained Dark Brown	USD 1,206.00	-
MARDCT3814-WHIT	White	USD 1,206.00	-

BASE TABLE SERIES

FOR MORE INFORMATION,
EXPLORE BELOW

- ↗ [Product Fact Sheet](#)
- ↗ [Images](#)
- ↗ [Architect Files](#)
- ↗ [Assembly Instructions](#)
- ↗ [Product Declaration](#)

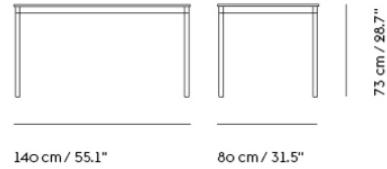

Shipper Colli	2
Gross Weight (kg)	25.7
Net Weight (kg)	22.3
Warranty Period	10 years

Pattern No.	Color	Contract Price	Lead Time
Ready-To-Ship US Warehouse			
MBTR553229LN-BLCK-WHIT-PLY	White Laminate/Plywood/Black	USD 1,626.00	-
MBTR553229LN-WHIT-WHIT-PLY	White Laminate/Plywood/White	USD 1,626.00	-
MBTR553229LN-BLCK-WHIT-WHIT	White Laminate/White ABS/Black	USD 1,626.00	-
MBTR553229LN-WHIT-WHIT-WHIT	White Laminate/White ABS/White	USD 1,626.00	-
MBTR553229VN-BLCK-OAK-PLY	Lacquered Oak Veneer/Plywood/Black	USD 2,046.00	-
MBTR553229VN-WHIT-OAK-PLY	Lacquered Oak Veneer/Plywood/White	USD 2,046.00	-
MBTR553229ON-BLCK-BLCK-PLY	Black Linoleum/Plywood/Black	USD 1,731.00	-
Ready-To-Ship EU Warehouse			
MBTR553229ON-WHIT-BLCK-PLY	Black Linoleum/Plywood/White	USD 1,731.00	-
Extras			
MLINSYSCG29-BLCK	Cable Guide - H: 73 cm / 28,7" - Black	USD 52.00	-
MLINSYSCG29-GREY	Cable Guide - H: 73 cm / 28,7" - Grey	USD 52.00	-

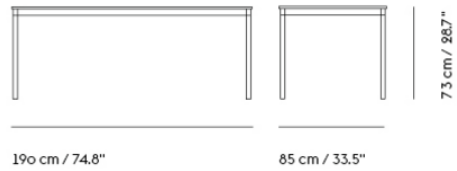

Shipper Colli	2
Gross Weight (kg)	33.9
Net Weight (kg)	28.09
Warranty Period	10 years

Pattern No.	Color	Contract Price	Lead Time
Ready-To-Ship US Warehouse			
MBTR753429LN-BLCK-WHIT-PLY	White Laminate/Plywood/Black	USD 1,836.00	-
MBTR753429LN-WHIT-WHIT-PLY	White Laminate/Plywood/White	USD 1,836.00	-
MBTR753429LN-BLCK-WHIT-WHIT	White Laminate/White ABS/Black	USD 1,836.00	-
MBTR753429LN-WHIT-WHIT-WHIT	White Laminate/White ABS/White	USD 1,836.00	-
MBTR753429VN-BLCK-OAK-PLY	Lacquered Oak Veneer/Plywood/Black	USD 2,515.00	-
MBTR753429VN-WHIT-OAK-PLY	Lacquered Oak Veneer/Plywood/White	USD 2,515.00	-
MBTR753429ON-BLCK-BLCK-PLY	Black Linoleum/Plywood/Black	USD 2,151.00	-
MBTR753429ON-WHIT-BLCK-PLY	Black Linoleum/Plywood/White	USD 2,151.00	-
Extras			
MLINSYSCG29-BLCK	Cable Guide - H: 73 cm / 28,7" - Black	USD 52.00	-
MLINSYSCG29-GREY	Cable Guide - H: 73 cm / 28,7" - Grey	USD 52.00	-

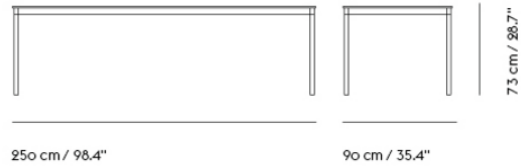

Shipper Colli 2
Gross Weight (kg) 46.7
Net Weight (kg) 40.08
Warranty Period 10 years

Pattern No.	Color	Contract Price	Lead Time
Ready-To-Ship US Warehouse			
MBTR993629LN-BLCK-WHIT-PLY	White Laminate/Plywood/Black	USD 2,515.00	-
MBTR993629LN-WHIT-WHIT-PLY	White Laminate/Plywood/White	USD 2,515.00	-
MBTR993629LN-BLCK-WHIT-WHIT	White Laminate/White ABS/Black	USD 2,515.00	-
MBTR993629LN-WHIT-WHIT-WHIT	White Laminate/White ABS/White	USD 2,515.00	-
MBTR993629VN-BLCK-OAK-PLY	Lacquered Oak Veneer/Plywood/Black	USD 3,411.00	-
MBTR993629VN-WHIT-OAK-PLY	Lacquered Oak Veneer/Plywood/White	USD 3,411.00	-
MBTR993629ON-BLCK-BLCK-PLY	Black Linoleum/Plywood/Black	USD 3,040.00	-
MBTR993629ON-WHIT-BLCK-PLY	Black Linoleum/Plywood/White	USD 3,040.00	-
Extras			
MLINSYSCG29-BLCK	Cable Guide - H: 73 cm / 28,7" - Black	USD 52.00	-
MLINSYSCG29-GREY	Cable Guide - H: 73 cm / 28,7" - Grey	USD 52.00	-

BASE ROUND TABLE / Ø 110 CM / 43.3"

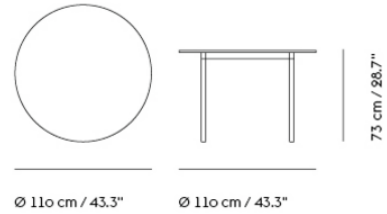

Shipper Colli	2
Gross Weight (kg)	19.1
Net Weight (kg)	14
Warranty Period	10 years

Pattern No.	Color	Contract Price	Lead Time
Ready-To-Ship EU Warehouse			
MBTO4329LN-BLCK-WHIT-PLY	White Laminate/Plywood/Black	USD 1,626.00	-
MBTO4329LN-WHIT-WHIT-PLY	White Laminate/Plywood/White	USD 1,626.00	-
MBTO4329ON-BLCK-BLCK-PLY	Black Linoleum/Plywood/Black	USD 1,836.00	-
MBTO4329ON-WHIT-BLCK-PLY	Black Linoleum/Plywood/White	USD 1,836.00	-
Extras			
MLINSYSCG29-BLCK	Cable Guide - H: 73 cm / 28,7" - Black	USD 52.00	-

BASE HIGH TABLE / 190 X 50 H: 95 CM / 74.8 X 19.7 H: 37.4"

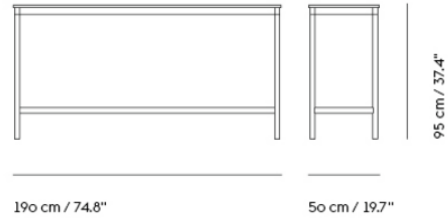

Shipper Colli	2
Gross Weight (kg)	38
Net Weight (kg)	33.2
Warranty Period	10 years

Pattern No.	Color	Contract Price	Lead Time
Ready-To-Ship US Warehouse			
MBHTR752038LN-BLCK-WHIT-PLY	White Laminate/Plywood/Black	USD 2,676.00	-
MBHTR752038LN-WHIT-WHIT-PLY	White Laminate/Plywood/White	USD 2,676.00	-
MBHTR752038LN-BLCK-WHIT-WHIT	White Laminate/White ABS/Black	USD 2,676.00	-
MBHTR752038LN-WHIT-WHIT-WHIT	White Laminate/White ABS/White	USD 2,676.00	-
MBHTR752038VN-BLCK-OAK-PLY	Lacquered Oak Veneer/Plywood/Black	USD 3,355.00	-
MBHTR752038VN-WHIT-OAK-PLY	Lacquered Oak Veneer/Plywood/White	USD 3,355.00	-
MBHTR752038ON-BLCK-BLCK-PLY	Black Linoleum/Plywood/Black	USD 3,040.00	-
MBHTR752038ON-WHIT-BLCK-PLY	Black Linoleum/Plywood/White	USD 3,040.00	-
Extras			
MLINSYSCG37-BLCK	Cable Guide - H: 95 cm / 37,4" - Black	USD 72.00	-
MLINSYSCG37-GREY	Cable Guide - H: 95 cm / 37,4" - Grey	USD 72.00	-

BASE HIGH TABLE / 190 X 50 H: 105 CM / 74.8 X 19.7 H: 41.3"

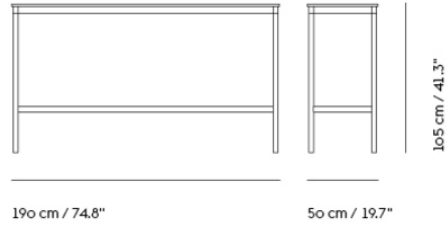

Shipper Colli 2
 Gross Weight (kg) 39
 Net Weight (kg) 34.2
 Warranty Period 10 years

Pattern No.	Color	Contract Price	Lead Time
Ready-To-Ship US Warehouse			
MBHTR752041LN-BLCK-WHIT-PLY	White Laminate/Plywood/Black	USD 2,676.00	-
MBHTR752041LN-WHIT-WHIT-PLY	White Laminate/Plywood/White	USD 2,676.00	-
MBHTR752041LN-BLCK-WHIT-WHIT	White Laminate/White ABS/Black	USD 2,676.00	-
MBHTR752041LN-WHIT-WHIT-WHIT	White Laminate/White ABS/White	USD 2,676.00	-
MBHTR752041VN-BLCK-OAK-PLY	Lacquered Oak Veneer/Plywood/Black	USD 3,355.00	-
MBHTR752041VN-WHIT-OAK-PLY	Lacquered Oak Veneer/Plywood/White	USD 3,355.00	-
MBHTR752041ON-BLCK-BLCK-PLY	Black Linoleum/Plywood/Black	USD 3,040.00	-
MBHTR752041ON-WHIT-BLCK-PLY	Black Linoleum/Plywood/White	USD 3,040.00	-
Extras			
MLINSYSCG41-BLCK	Cable Guide - H: 105 cm / 41,3" - Black	USD 72.00	-
MLINSYSCG41-GREY	Cable Guide - H: 105 cm / 41,3" - Grey	USD 72.00	-

BASE HIGH TABLE / 190 X 85 H: 95 CM / 74.8 X 33.5 H: 37.4"

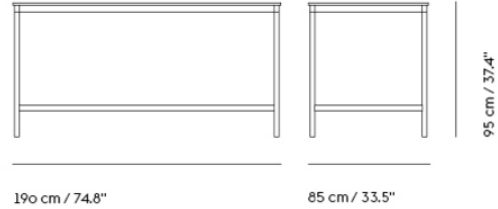

Shipper Colli	2
Gross Weight (kg)	44
Net Weight (kg)	37.25
Warranty Period	10 years

Pattern No.	Color	Contract Price	Lead Time
Ready-To-Ship US Warehouse			
MBHTR753438LN-BLCK-WHIT-PLY	White Laminate/Plywood/Black	USD 2,676.00	-
MBHTR753438LN-WHIT-WHIT-PLY	White Laminate/Plywood/White	USD 2,676.00	-
MBHTR753438LN-BLCK-WHIT-WHIT	White Laminate/White ABS/Black	USD 2,676.00	-
MBHTR753438LN-WHIT-WHIT-WHIT	White Laminate/White ABS/White	USD 2,676.00	-
MBHTR753438VN-BLCK-OAK-PLY	Lacquered Oak Veneer/Plywood/Black	USD 3,355.00	-
MBHTR753438VN-WHIT-OAK-PLY	Lacquered Oak Veneer/Plywood/White	USD 3,355.00	-
MBHTR753438ON-BLCK-BLCK-PLY	Black Linoleum/Plywood/Black	USD 3,040.00	-
MBHTR753438ON-WHIT-BLCK-PLY	Black Linoleum/Plywood/White	USD 3,040.00	-
Extras			
MLINSYSCG37-BLCK	Cable Guide - H: 95 cm / 37,4" - Black	USD 72.00	-
MLINSYSCG37-GREY	Cable Guide - H: 95 cm / 37,4" - Grey	USD 72.00	-

BASE HIGH TABLE / 190 X 85 H: 105 CM / 74.8 X 33.5 H: 41.3"

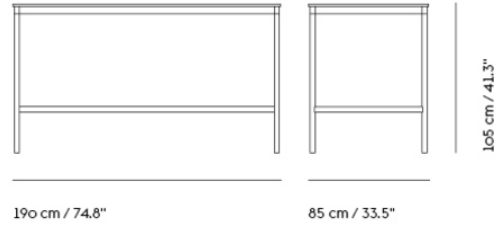

Shipper Colli 2
 Gross Weight (kg) 45
 Net Weight (kg) 38.25
 Warranty Period 10 years

Pattern No.	Color	Contract Price	Lead Time
Ready-To-Ship US Warehouse			
MBHTR753441LN-BLCK-WHIT-PLY	White Laminate/Plywood/Black	USD 2,676.00	-
MBHTR753441LN-WHIT-WHIT-PLY	White Laminate/Plywood/White	USD 2,676.00	-
MBHTR753441LN-BLCK-WHIT-WHIT	White Laminate/White ABS/Black	USD 2,676.00	-
MBHTR753441LN-WHIT-WHIT-WHIT	White Laminate/White ABS/White	USD 2,676.00	-
MBHTR753441VN-BLCK-OAK-PLY	Lacquered Oak Veneer/Plywood/Black	USD 3,355.00	-
MBHTR753441VN-WHIT-OAK-PLY	Lacquered Oak Veneer/Plywood/White	USD 3,355.00	-
MBHTR753441ON-BLCK-BLCK-PLY	Black Linoleum/Plywood/Black	USD 3,040.00	-
MBHTR753441ON-WHIT-BLCK-PLY	Black Linoleum/Plywood/White	USD 3,040.00	-
Extras			
MLINSYSCG41-BLCK	Cable Guide - H: 105 cm / 41,3" - Black	USD 72.00	-
MLINSYSCG41-GREY	Cable Guide - H: 105 cm / 41,3" - Grey	USD 72.00	-

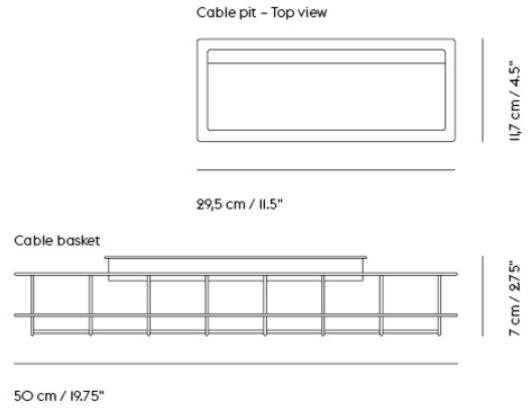

Shipper Colli 1
Gross Weight (kg) 0.6133
Net Weight (kg) 0.6133
Warranty Period 5 years

Pattern No.	Color	Contract Price	Lead Time
Ready-To-Ship US Warehouse			
MCBLPIT	Aluminum	USD 341.00	-
MCBLBKT	Black	USD 341.00	-

BASE TABLE

Shipper Colli 2
 Warranty Period 5 years for L440 cm, L300 cm, L440 cm and Ø128 cm variants.
 10 years for all other variants

All dimensions of the Base Table are identical, both with and without castors.

All Variants

70 x 70 CM / 27.5 x 27.5 IN

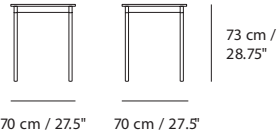

250 x 90 CM / 98.5 x 35.5 IN

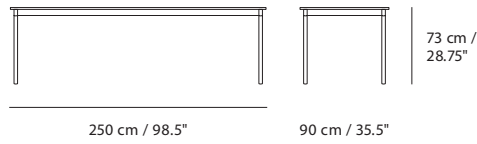

80 x 80 CM / 31.5 x 31.5 IN

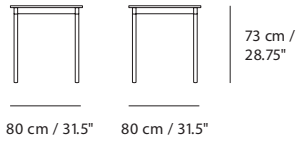

250 x 110 CM / 98.5 x 43.25 IN

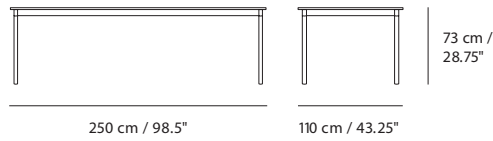

140 x 70 CM / 55 x 27.5 IN

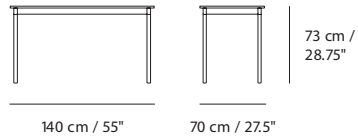

300 x 110 CM / 118 x 43.25 IN

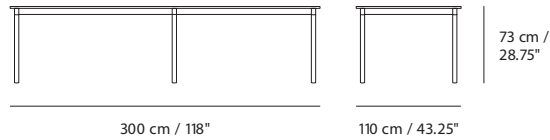

140 x 80 CM / 55 x 31.5 IN

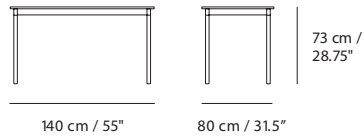

440 x 110 CM / 173.25 x 43.25 IN

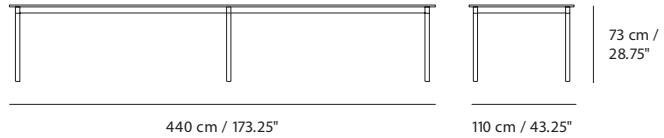

160 x 80 CM / 63 x 31.5 IN

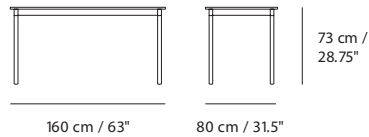

BASE ROUND TABLE

Ø 90 CM / 35.5 IN

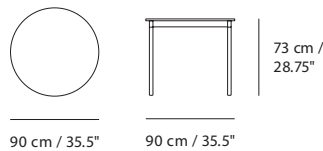

190 x 80 CM / 75 x 31.5 IN

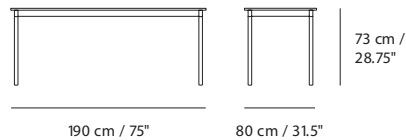

Ø 110 CM / 43.25 IN

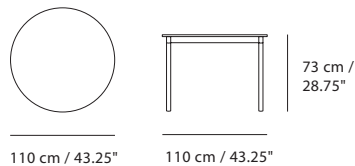

190 x 85 CM / 75 x 33.5 IN

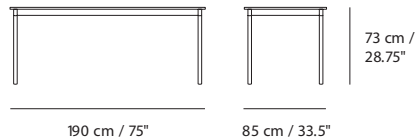

128 x 128 CM / 50.5 x 50.5 IN

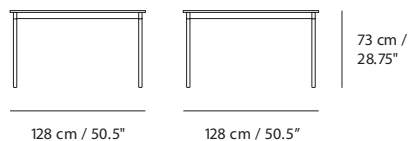

Ø 128 CM / 50.5 IN

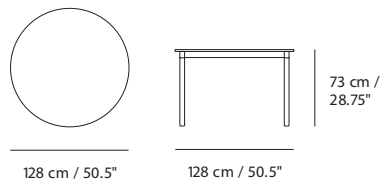

BASE TABLE

All Variants

Sizes	Pattern No.	Width/ diame- ter	Depth	Height	Weight (kg)	Contract Price					
							Laminate (L) w/ABS edge	Laminate (L) w/ply- wood edge	Linoleum (O) w/plywood edge	Oak veneer (V) w/plywood edge	Nanolami- nate (N) w/plywood edge
Base Table Rectangular											
140 X 70 CM / 55.1 X 27.5"	M-BTR-55-28-29	55"	27.5"	28.75"	19.5	without castors	1,626	1,626	1,675	1,731	2,046
						with castors	1,731	1,731	1,885	2,046	2,256
140 X 80 CM / 55.1 X 31.5"	M-BTR-55-32-29	55"	31.5"	28.75"	23	without castors	1,626	1,626	1,731	2,046	2,256
						with castors	1,731	1,731	2,046	2,151	2,410
160 X 80 CM / 63 X 31.5 "	M-BTR-63-32-29	63"	31.5"	28.75"	23	without castors	1,836	1,836	2,046	2,151	2,305
						with castors	2,046	2,046	2,151	2,305	2,515
190 X 80 CM / 74.8 X 31.5"	M-BTR-75-32-29	74.75"	31.5"	28.75"	26	without castors	1,675	1,675	2,151	2,515	2,515
						with castors	1,885	1,885	2,305	2,676	2,676
190 X 85 CM / 74.8 X 33.5"	M-BTR-75-34-29	74.75"	33.5"	28.75"	30.5	without castors	1,836	1,836	2,151	2,515	2,571
						with castors	2,046	2,046	2,305	2,676	2,781
250 X 90 CM / 98.4 X 35.4"	M-BTR-99-36-29	98.5"	35.5"	28.75"	42	without castors	2,515	2,515	3,040	3,411	3,355
						with castors	2,676	2,676	3,145	3,621	3,565
250 X 110 CM / 98.4 X 43.3"	M-BTR-99-43-29	98.5"	43.5"	28.75"	47.5	without castors	2,676	2,676	3,355	3,565	3,411
						with castors	2,886	2,886	3,565	3,831	3,565
300 X 110 CM / 118.1 X 43.3"	M-BTR-118-43-29	118"	43.5"	28.75"	50	without castors	3,145	3,145	3,621	3,831	3,621
						with castors	3,355	3,355	3,880	3,985	3,880
440 X 110 CM / 173.3 X 43.3"	M-BTR-173-43-29	173"	43.5"	28.75"	64.5	without castors	3,985	3,985	4,986	5,035	4,776
						with castors	4,146	4,146	5,035	5,245	4,986
Base Table Square											
70 X 70 CM / 27.6 X 27.6"	M-BTS-28-28-29	27.5"	27.5"	28.75"	13	without castors	1,570	1,570	1,570	1,570	2,046
						with castors	1,675	1,675	1,731	1,731	2,151
80 X 80 CM / 31.5 X 31.5"	M-BTS-32-32-29	31.5"	31.5"	28.75"	15	without castors	1,570	1,570	1,570	1,626	2,046
						with castors	1,731	1,731	1,731	1,836	2,256
128 X 128 CM / 50.4 X 50.4"	M-BTS-51-51-29	50.5"	50.5"	28.75"	27	without castors	1,836	1,836	2,151	2,151	2,305
						with castors	2,095	2,095	2,305	2,305	2,515
Base Round Table											
Ø 90 CM / 35.4"	M-BTO-36-29	35.5"		28.75"	13.5	without castors	1,626	1,626	1,731	1,836	2,151
						with castors	1,731	1,731	2,046	2,046	2,305
Ø 110 CM / 43.3 "	M-BTO-43-29	43.5"		28.75"	17.5	without castors	1,626	1,626	1,836	1,836	2,151
						with castors	1,836	1,836	2,046	2,095	2,305
Ø 128 CM / 50.4"	M-BTO-51-29	50.5"		28.75"	21.5	without castors	1,626	1,626	2,046	2,046	2,256
						with castors	1,836	1,836	2,151	2,256	2,410

HOW TO CONFIGURE

ORDER CODE EXAMPLE

Specify:

Base Table 28x28" in white laminate and white base

- Step 1) Select size
- Step 2) Select table top material"
- Step 3) Select castors (C) or without castors (N)"
- Step 4) Select base color"
- Step 5) Select table top color"
- Step 6) Select edge finish"

Size
Table top material
Choose castors (C) or without castors (N)
Base color
Table top finish
Edge finish
Final Pattern No:

Base Table Square 28"
Laminate
Castors
White base
White
Plywood
MBTS282829LCWHITWHITPLY

MBTS282829
L
C
WHIT
WHIT
PLY

Table Top Material	Base Color Options	Table Top Finish	Edge Finish Options
L - Laminate O - Linoleum V - Veneer N - Nanolaminate	WHIT - White BLCK - Black	Laminate WHIT - White BLCK - Black Linoleum BLCK - Black Veneer OAK - Oak Nanolaminate WHIT - White BLCK - Black	PLY - Plywood (available for all All Variants) WHIT - White ABS (available with laminate only) BLCK - Black ABS (available with laminate only)

BASE HIGH TABLE



Shipper Colli 2
 Warranty Period 5 years for L440 cm, L300 cm, L440 cm and Ø128 cm variants.
 10 years for all other variants

All dimensions of the Base High Table are identical, both with and without castors.

All Variants

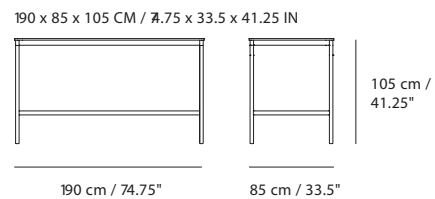
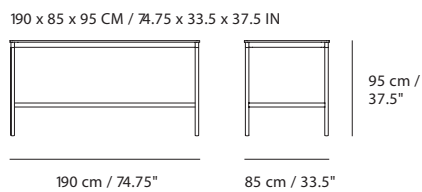
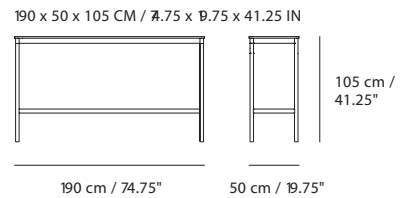
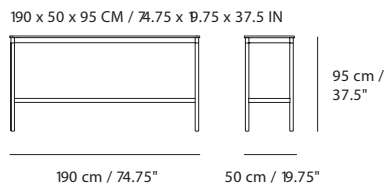
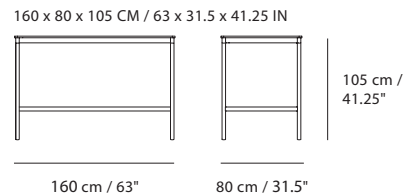
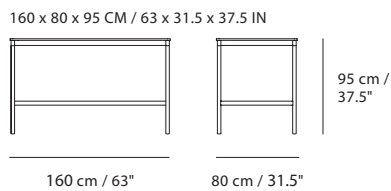
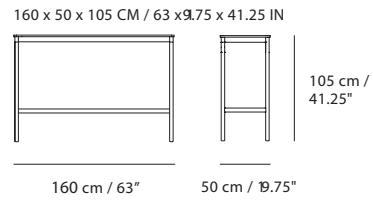
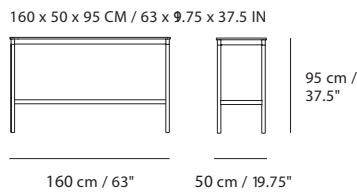

BASE HIGH TABLE

All Variants

Pattern No.	Width/ diameter rounded up	Depth	Height	Weight (kg)		Contract Price	Laminate (L) with ABS edge	Laminate (L) with plywood edge	Linoleum (O) with plywood edge	Oak Veneer (V) with plywood edge	Nanolami- nate (N) with plywood edge
M-BHTR-63-20-38	63"	19.75"	37.5"	32	without castors	2,571	2,571	2,886	3,040	3,145	
					with castors	2,781	2,781	3,096	3,145	3,355	
M-BHTR-63-20-41	63"	19.75"	41.25"	32.5	without castors	2,571	2,571	2,886	3,040	3,145	
					with castors	2,781	2,781	3,096	3,145	3,355	
M-BHTR-63-32-38	63"	31.5"	37.5"	32	without castors	2,571	2,571	2,886	3,040	3,145	
					with castors	2,781	2,781	3,096	3,145	3,355	
M-BHTR-63-32-41	63"	31.5"	41.25"	34	without castors	2,571	2,571	2,886	3,040	3,145	
					with castors	2,781	2,781	3,096	3,145	3,355	
M-BHTR-75-20-38	75"	19.75"	37.5"	34.5	without castors	2,676	2,676	3,040	3,355	3,565	
					with castors	2,886	2,886	3,145	3,565	3,831	
M-BHTR-75-20-41	75"	19.75"	41.25"	35	without castors	2,676	2,676	3,040	3,355	3,565	
					with castors	2,886	2,886	3,145	3,565	3,831	
M-BHTR-75-34-38	75"	33.5"	37.5"	40	without castors	2,676	2,676	3,040	3,355	3,355	
					with castors	2,886	2,886	3,145	3,565	3,565	
M-BHTR-75-34-41	75"	33.5"	41.25"	40.5	without castors	2,676	2,676	3,040	3,355	3,565	
					with castors	2,886	2,886	3,145	3,565	3,831	

HOW TO CONFIGURE

Base Table

- Step 1) Select Size
- Step 2) Select table top material
- Step 3) Select castors (C) or without castors (N)
- Step 4) Select Frame color
- Step 5) Select Table top color
- Step 6) Select Edge finish

ORDER CODE EXAMPLE

Base High Table Bar Height 63X19.7" in black linoleum and black frame

Size	Base High Table Bar Height Table 63X19.7"	MBHTR632041ON
Table top material	Linoleum	O
Choose castors (C) or without castors (N)	Without castors	N
Base color	Black	BLCK
Table top finish	Black	BLCK
Edge finish	Plywood	PLY
Final Pattern No:	MBHTR632041ONBLCKBLCKPLY	

Table Top Material	Base Color Options	Table Top Finish	Edge Finish Options
L - Laminate O - Linoleum V - Veneer N - Nanolaminate	WHIT - White BLCK - Black	Laminate WHIT - White BLCK - Black	PLY - Plywood (available for all All Variants) WHIT - White ABS (available with laminate only) BLCK - Black ABS (available with laminate only)
		Linoleum BLCK - Black	
		Veneer OAK - Oak	
		Nanolaminate WHIT - White BLCK - Black	

COMPILE SHELVING SYSTEM

FOR MORE INFORMATION,
EXPLORE BELOW

- ↗ [Product Fact Sheet](#)
- ↗ [Images](#)
- ↗ [Architect Files](#)
- ↗ [Assembly Instructions](#)
- ↗ [Product Declaration](#)

COMPILE SHELVING SYSTEM / CONFIGURATION I

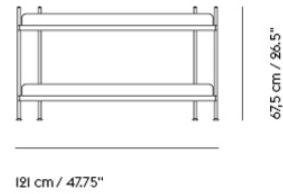

Shipper Colli 3
Gross Weight (kg) 22.74
Net Weight (kg) 18.27
Warranty Period 10 years

Pattern No.	Color	Contract Price	Lead Time
Ready-To-Ship EU Warehouse			
MCOMSC1-BLCK	Black	USD 866.00	-
MCOMSC1-GREY	Grey	USD 866.00	-
MCOMSC1-WHIT	White	USD 866.00	-

COMPILE SHELVING SYSTEM / CONFIGURATION 2

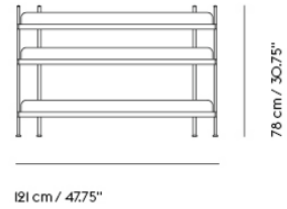

Shipper Colli 4
Gross Weight (kg) 33.55
Net Weight (kg) 27.11
Warranty Period 10 years

Pattern No.	Color	Contract Price	Lead Time
Ready-To-Ship EU Warehouse			
MCOMSC2-BLCK	Black	USD 1,255.00	-
MCOMSC2-GREY	Grey	USD 1,255.00	-
MCOMSC2-WHIT	White	USD 1,255.00	-

COMPILE SHELVING SYSTEM / CONFIGURATION 3



Shipper Colli 6
Gross Weight (kg) 55.96
Net Weight (kg) 45.49
Warranty Period 10 years

Pattern No.	Color	Contract Price	Lead Time
Ready-To-Ship EU Warehouse			
MCOMSC3-BLCK	Black	USD 2,046.00	-
MCOMSC3-GREY	Grey	USD 2,046.00	-
MCOMSC3-WHIT	White	USD 2,046.00	-

COMPILE SHELVING SYSTEM / CONFIGURATION 4

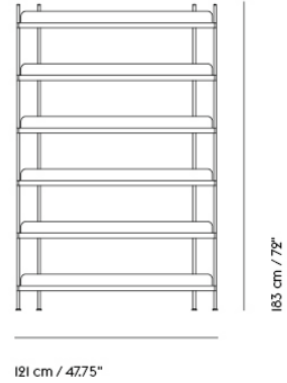

Shipper Colli 7
Gross Weight (kg) 67.16
Net Weight (kg) 54.69
Warranty Period 10 years

Pattern No.	Color	Contract Price	Lead Time
Ready-To-Ship EU Warehouse			
MCOMSC4-BLCK	Black	USD 2,410.00	-
MCOMSC4-GREY	Grey	USD 2,410.00	-
MCOMSC4-WHIT	White	USD 2,410.00	-

COMPILE SHELVING SYSTEM / CONFIGURATION 5

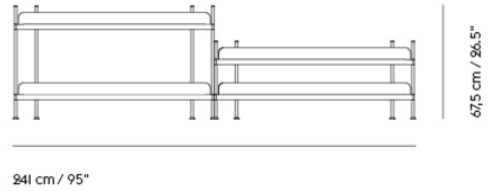

Shipper Colli 5
Gross Weight (kg) 44.85
Net Weight (kg) 36.24
Warranty Period 10 years

Pattern No.	Color	Contract Price	Lead Time
Ready-To-Ship EU Warehouse			
MCOMSC5-BLCK	Black	USD 1,836.00	-
MCOMSC5-GREY	Grey	USD 1,836.00	-
MCOMSC5-WHIT	White	USD 1,836.00	-

COMPILE SHELVING SYSTEM / CONFIGURATION 6

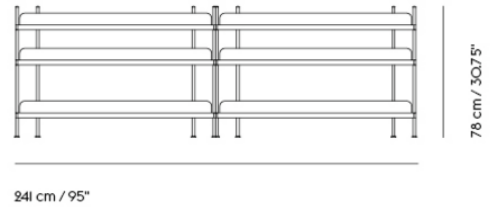

Shipper Colli 7
Gross Weight (kg) 66.81
Net Weight (kg) 54.21
Warranty Period 10 years

Pattern No.	Color	Contract Price	Lead Time
Ready-To-Ship EU Warehouse			
MCOMSC6-BLCK	Black	USD 2,571.00	-
MCOMSC6-GREY	Grey	USD 2,571.00	-
MCOMSC6-WHIT	White	USD 2,571.00	-

COMPILE SHELVING SYSTEM / CONFIGURATION 7

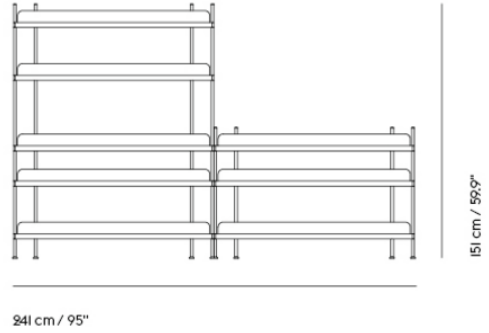

Shipper Colli 9
Gross Weight (kg) 89.22
Net Weight (kg) 72.6
Warranty Period 10 years

Pattern No.	Color	Contract Price	Lead Time
Ready-To-Ship EU Warehouse			
MCOMSC7-BLCK	Black	USD 3,516.00	-
MCOMSC7-GREY	Grey	USD 3,516.00	-
MCOMSC7-WHIT	White	USD 3,516.00	-

COMPILE SHELVING SYSTEM / CONFIGURATION 8

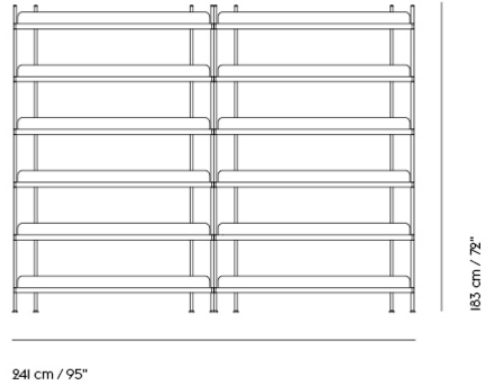

Shipper Colli 13
Gross Weight (kg) 134.03
Net Weight (kg) 109.39
Warranty Period 10 years

Pattern No.	Color	Contract Price	Lead Time
Ready-To-Ship EU Warehouse			
MCOMSC8-BLCK	Black	USD 4,881.00	-
MCOMSC8-GREY	Grey	USD 4,881.00	-
MCOMSC8-WHIT	White	USD 4,881.00	-

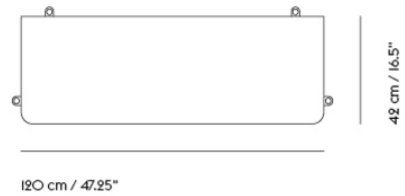

Shipper Colli 1
 Gross Weight (kg) 10.67
 Net Weight (kg) 8.7
 Warranty period 10 years

Pattern No.	Color	Contract Price	Lead Time
Ready-To-Ship EU Warehouse			
MCOMSH-BLCK	Black	USD 383.00	-
MCOMSH-GREY	Grey	USD 383.00	-
MCOMSH-WHIT	White	USD 383.00	-

COMPILE SHELVING SYSTEM ESSENTIAL PACK

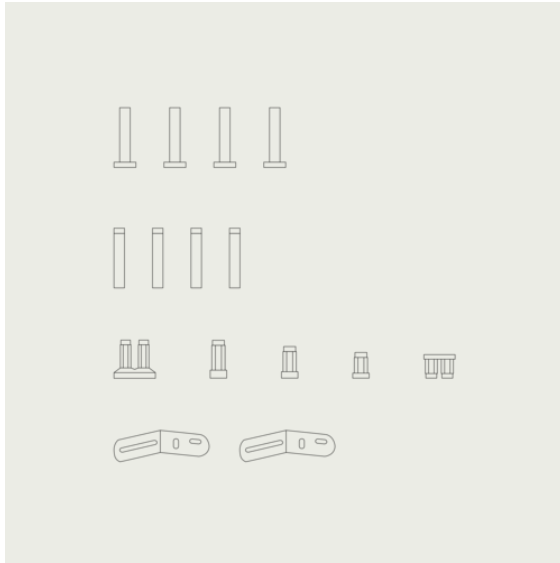

Shipper Colli 1
Gross Weight (kg) 0.5
Net Weight (kg) 0.3178
Warranty period 10 years

Pattern No.	Color	Contract Price	Lead Time
Ready-To-Ship EU Warehouse			
MCOMEP-BLCK	Black	USD 146.00	-
MCOMEP-GREY	Grey	USD 146.00	-
MCOMEP-WHIT	White	USD 146.00	-

COMPILE SHELVING SYSTEM DIVIDER PACK

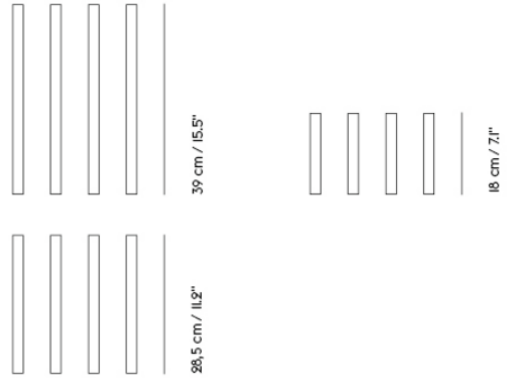
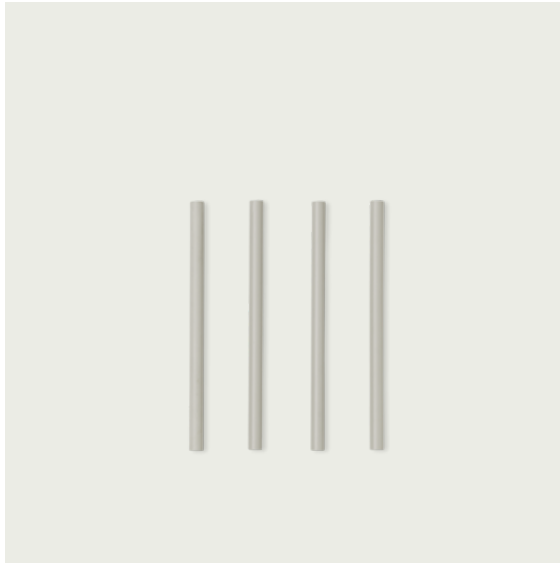

Shipper Colli 1
Gross Weight (kg) 0.28
Net Weight (kg) 0.253
Warranty period 10 years

Pattern No.	Color	Contract Price	Lead Time
Ready-To-Ship EU Warehouse			
MCOMSDLG-BLCK	Black - Large	USD 58.00	-
MCOMSDMD-BLCK	Black - Medium	USD 58.00	-
MCOMSDSM-BLCK	Black - Small	USD 58.00	-
MCOMSDLG-GREY	Grey - Large	USD 58.00	-
MCOMSDMD-GREY	Grey - Medium	USD 58.00	-
MCOMSDSM-GREY	Grey - Small	USD 58.00	-
MCOMSDLG-WHIT	White - Large	USD 58.00	-
MCOMSDMD-WHIT	White - Medium	USD 58.00	-
MCOMSDSM-WHIT	White - Small	USD 58.00	-

CONNECT MODULAR SOFA SERIES

FOR MORE INFORMATION,
EXPLORE BELOW

- ↗ Product Fact Sheet
- ↗ Images
- ↗ Architect Files
- ↗ Assembly Instructions
- ↗ Product Declaration
- ↗ Product Planner

Designed with long, elegant lines, the Connect Modular Sofa's details of its small feet underneath for a hovering, light sentiment and pointy corners allow for the design to bring character to any space.

Create your own Connect Modular Sofa by choosing from 11 modules, following the guidelines below.

Visit planner.muuto.com to create your own configuration online.

Create your own Connect Configuration

1. SEATING MODULES



Select your desired seating modules.

Add the item numbers of the desired textile separately to your order.

Note

You can only connect seating modules with pre-mounted linking brackets on the sides, illustrated here with dotted lines. Please note that the modules H & I can only be used as a freestanding ottoman and not part of the sofa configuration.

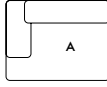
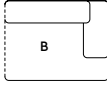
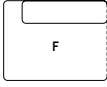
END MODULES

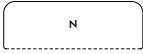
				D 98 cm / 38.58" SD 64 cm / 25.20"		D 68 cm / 26.77" SD 68 cm / 26.77"
W 118,5 cm / 46.65" SW 88 cm / 34.65"	W 118,5 cm / 46.65" SW 88 cm / 34.65"	W 118,5 cm / 46.65"	W 118,5 cm / 46.65"		W 196 cm / 77.17"	

END & LOUNGE MODULES

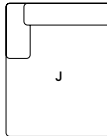
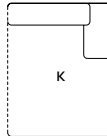
		D 155 cm / 61.02" SD 192 cm / 48.03"
W 118,5 cm / 46.65" SW 88 cm / 34.65"	W 118,5 cm / 46.65" SW 88 cm / 34.65"	

CENTER & CORNER MODULES

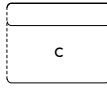
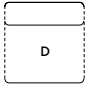
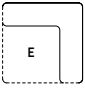
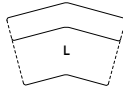
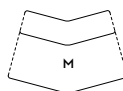
			D 98 cm / 38.58"
W 118,5 cm / 46.65"	W 94,5 cm / 37.20"	W 98 cm / 38.58"	
			D 113 cm / 44.49" SD 64 cm / 25.20"
W 158 cm / 62.20" SW 144 cm / 56.69"			
			D 113 cm / 44.49" SD 64 cm / 25.20"
W 158 cm / 62.20" SW 125 cm / 49.21"			

FREESTANDING MODULES

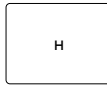
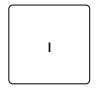
		D 98 cm / 38.58"
W 118,5 cm / 46.65"	98 cm / 38.58"	

Textile direction

Corner Module E is designed to be used as corner. If used as End Module with armrest, the textile direction can differ. Modules connected on the left side of Corner Module E will have the same textile direction. The textile direction of modules connected on the right side will run into the opposite direction.



INSPIRATION FOR YOUR CONFIGURATION

2-seater Configurations

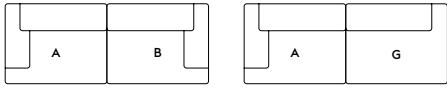

3-seater Configurations

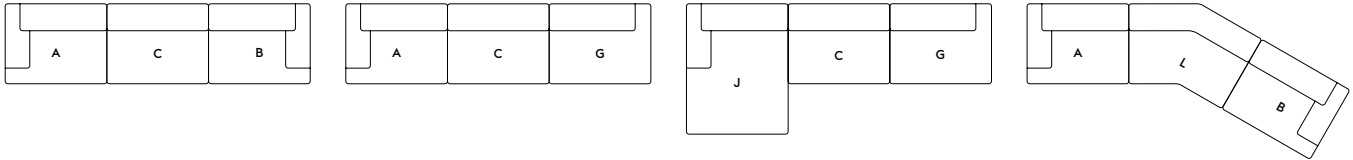

4-seater Configurations

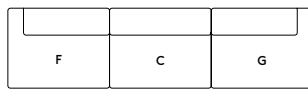
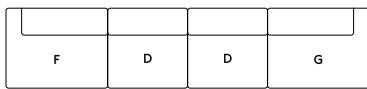

Corner Configuration

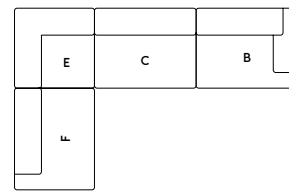

Back-To-Back Configurations

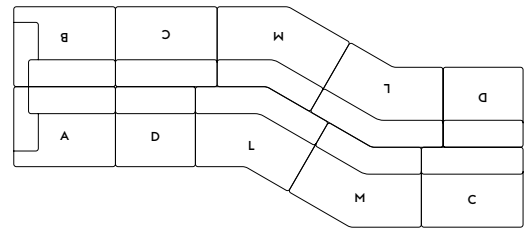
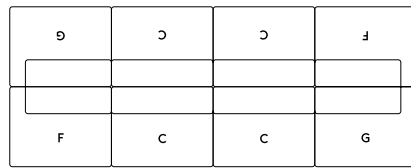
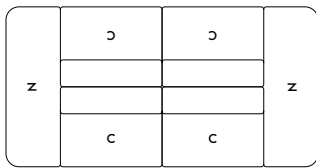

6-seater Configurations

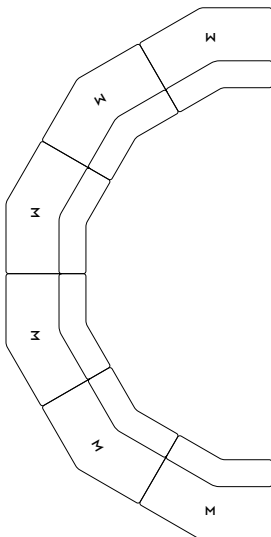

CONNECT SOFA SERIES

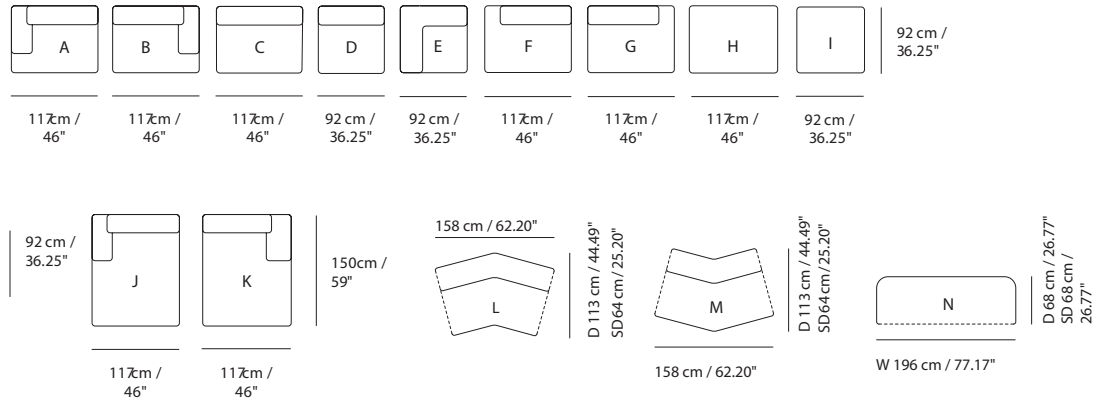

Shipper Colli 1
 Directional Modules Right and left refers to the side when facing the product from the front.
 Warranty Period 10 years

All Variants

Modules	Pattern No.	Weight (kg)	Contract Price Upholstery Grades			
			A	B	C	E
Left Armrest (A)	M-CONAM-L	50	2,305	2,781	2,830	2,886
Right Armrest (B)	M-CONAM-R	50	2,305	2,781	2,830	2,886
Long Center (C)	M-CONCM-L	43	2,305	2,781	2,830	2,886
Short Center (D)	M-CONCM-S	28	2,046	2,256	2,361	2,410
Corner (E)	M-CONC	50	2,305	2,571	2,781	2,830
Left Open-ended (F)	M-CONOM-L	42	2,305	2,515	2,571	2,620
Right Open-Ended (G)	M-CONOM-R	42	2,305	2,515	2,571	2,620
Long Ottoman (H)	M-CONOTT-L	39	1,465	1,675	1,836	2,095
Short Ottoman (I)	M-CONOTT-S	27	1,416	1,570	1,731	1,836
Left Armrest Lounge (J)	M-CONLM-L	70	3,096	3,565	3,621	3,831
Right Armrest Lounge (K)	M-CONLM-R	70	3,096	3,565	3,621	3,831
Angle Module 150 degrees (L)	M-CONAN150	47	3,096	3,565	3,621	3,831
Angle Module 210 degrees (M)	M-CONAN210	44	3,096	3,565	3,621	3,831
End Module (N)	M-CONEND	31	2,305	2,781	2,830	2,886

HOW TO CONFIGURE

ORDER CODE EXAMPLE

Connect Sofa Connect sofa - A + D + B in Ocean 80

Specify: Modules Connect A + D + B MCONAML
 MCONCMS
 MCONAMR
 Step 1) Choose modules Ocean
 Step 2) Choose Textile 80
 Step 3) Choose Textile color Final Pattern No.s (one per module) MCONAMLM16180
 MCONCMSM16180
 MCONAMRM16180

Upholstery Options

A	B	C	E
Ocean (M161)* Remix (M156) Vancouver (M148) Wooly (M159)	Beck (M6376) Canvas (M153) Clara (M154) Fiord (M155) Grain (M12659) Manner (M12665) Steelcut (M149) Steelcut Quartet (M13042) Steelcut Trio (M139)	Hallingdal (M146)	Acca (M12660) Aegean (K2074) Clay (M2449)* Divina (M150) Divina MD (M147) Divina Melange (M135) Ecriture (M10767) Hearth (M12664) Twill Weave (M142) Vidar (M158)

*Notes:
 Ocean: Color 3, 21, 32, 50, 52, 80 & 601
 Clay - Color 1, 2, 3, 4, 5, 6, 7, 8, 9, 10, 11, 12, 13, 14, 15, 16 & 17

CONNECT SOFT MODULAR SOFA SERIES

FOR MORE INFORMATION,
EXPLORE BELOW

- ↗ [Product Fact Sheet](#)
- ↗ [Images](#)
- ↗ [Architect Files](#)
- ↗ [Assembly Instructions](#)
- ↗ [Product Declaration](#)
- ↗ [Product Planner](#)

The Connect Soft Modular Sofa brings together elegantly slender proportions with a deeply inviting and ultra-soft comfort. Being as the heart of any space, its modularity allows for its user to tailor the design to their exact taste and space.

Choose between 9 predefined configurations or create your own choosing from 9 seating modules and optional cushions, following the guidelines below.

Visit planner.muuto.com to create your own configuration online.

Create your own Connect Soft Configuration

1. SEATING MODULES

Select your desired seating modules.

Add the item numbers of the desired textile separately to your order.

Note

You can only connect seating modules with pre-mounted linking brackets on the sides, illustrated here with dotted lines. Pouf Module I can either be connected to other modules with pre-mounted linking brackets or be used as a freestanding module.

END MODULES

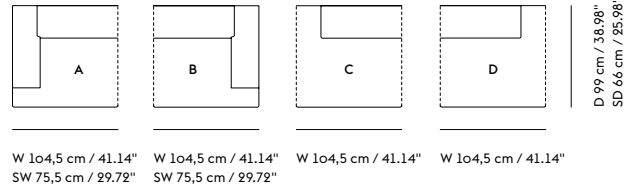

CENTER & CORNER MODULES

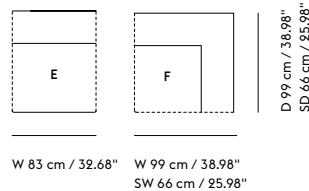

END & LOUNGE MODULES

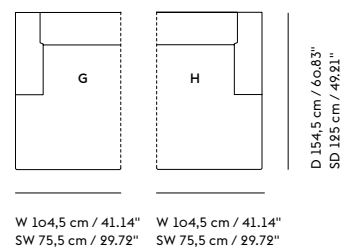

FREESTANDING MODULES

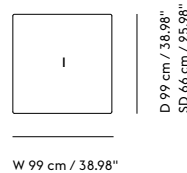

Textile direction

Corner Module F is designed to be used as corner. If used as End Module with armrest, the textile direction can differ. Modules connected on the left side of Corner Module F will have the same textile direction. The textile direction of modules connected on the right side will run into the opposite direction.

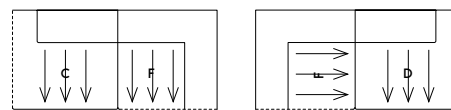

2. CUSHIONS

Specify optional cushions in the desired textile for added comfort and a lounging expression.

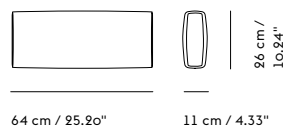

INSPIRATION FOR YOUR CONFIGURATION

2-seater Configurations

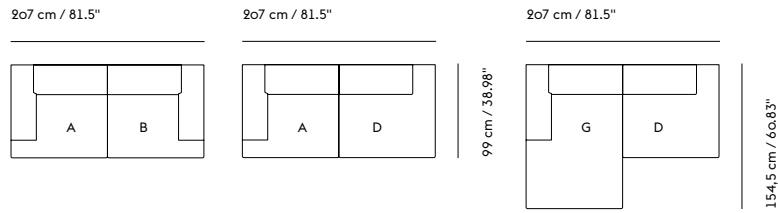

3-seater Configurations

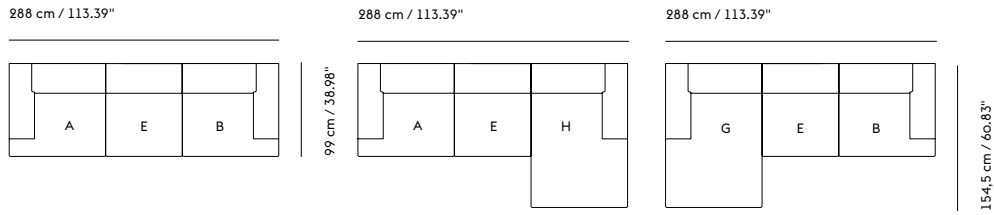

Corner Configurations

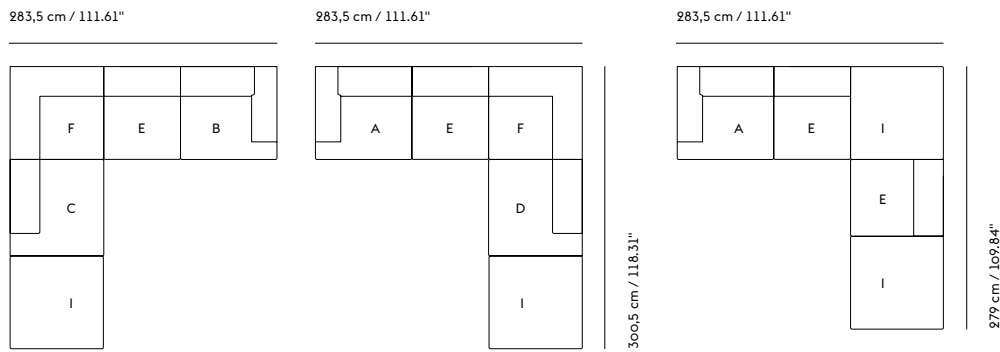

General note

The total dimensions of the configurations are indicative and can vary due to the inherent softness of the design and depending on how close the modules are placed as well as how many modules that are combined.

CONNECT SOFT MODULAR SOFA / LEFT ARMREST (A)

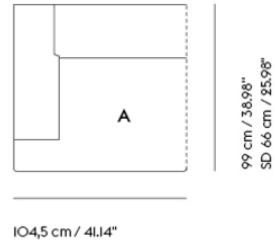

Shipper Colli	1
Gross Weight (kg)	50
Net Weight (kg)	38.3
Please note	This product features an armrest on the left-hand side when facing the product from the front.
Warranty Period	10 years

Pattern No.	Color	Contract Price	Lead Time
Ready-To-Ship US Warehouse			
MCONAMSL-M4586128	Re-wool 128 ***	USD 2,781.00	-
MCONAMSL-M244912	Clay 12	USD 2,886.00	-
Extras			
MLEAKIT	Leather care set for Refine Leather	USD 27.00	-

CONNECT SOFT MODULAR SOFA / RIGHT ARMREST (B)

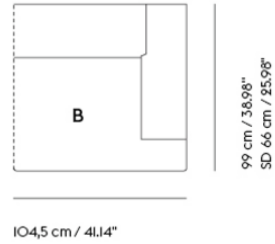

Shipper Colli	1
Gross Weight (kg)	50
Net Weight (kg)	38.3
Please note	This product features an armrest on the right-hand side when facing the product from the front
Warranty Period	10 years

Pattern No.	Color	Contract Price	Lead Time
Ready-To-Ship US Warehouse			
MCONAMSR-M4586128	Re-wool 128 ***	USD 2,781.00	-
MCONAMSR-M244912	Clay 12	USD 2,886.00	-
Extras			
MLEAKIT	Leather care set for Refine Leather	USD 27.00	-

CONNECT SOFT MODULAR SOFA / LEFT OPEN-ENDED (C)

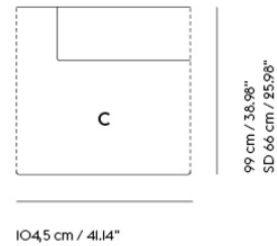

Shipper Colli	1
Gross Weight (kg)	46
Net Weight (kg)	34.3
Please note	This product features an open end on the left-hand side when facing the product from the front.
Warranty Period	10 years

Pattern No.	Color	Contract Price	Lead Time
Ready-To-Ship US Warehouse			
MCONOMSL-M4586128	Re-wool 128 ***	USD 2,515.00	-
MCONOMSL-M244912	Clay 12	USD 2,620.00	-
Extras			
MLEAKIT	Leather care set for Refine Leather	USD 27.00	-

CONNECT SOFT MODULAR SOFA / RIGHT OPEN-ENDED (D)

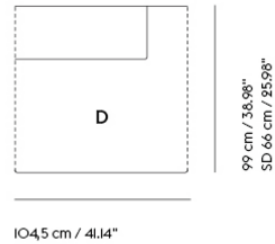

Shipper Colli	1
Gross Weight (kg)	46
Net Weight (kg)	34.3
Please note	This product features an open end on the right-hand side when facing the product from the front.
Warranty Period	10 years

Pattern No.	Color	Contract Price	Lead Time
Ready-To-Ship US Warehouse			
MCONOMSR-M4586128	Re-wool I28 ***	USD 2,515.00	-
MCONOMSR-M244912	Clay I2	USD 2,620.00	-
Extras			
MLEAKIT	Leather care set for Refine Leather	USD 27.00	-

CONNECT SOFT MODULAR SOFA / CENTER (E)

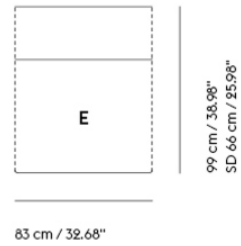

Shipper Colli |
Gross Weight (kg) 42
Net Weight (kg) 32.4
Warranty Period 10 years

Pattern No.	Color	Contract Price	Lead Time
Ready-To-Ship US Warehouse			
MCONCMSS-M4586128	Re-wool 128 ***	USD 2,956.00	-
MCONCMSS-M244912	Clay 12	USD 2,515.00	-
Extras			
MLEAKIT	Leather care set for Refine Leather	USD 27.00	-

CONNECT SOFT MODULAR SOFA / CORNER (F)

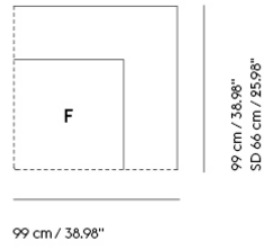

Shipper Colli |
Gross Weight (kg) 50.8
Net Weight (kg) 39.3
Warranty Period 10 years

Pattern No.	Color	Contract Price	Lead Time
Ready-To-Ship US Warehouse			
MCONCS-M4586128	Re-wool 128 ***	USD 2,571.00	-
MCONCS-M244912	Clay 12	USD 2,886.00	-
Extras			
MLEAKIT	Leather care set for Refine Leather	USD 27.00	-

CONNECT SOFT MODULAR SOFA / LEFT ARMREST CHAISE LOUNGE (G)

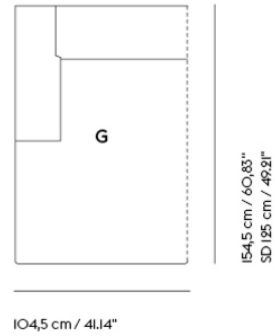

Shipper Colli	1
Gross Weight (kg)	67.2
Net Weight (kg)	52.1
Please note	This product features an armrest on the left-hand side when facing the product from the front.
Warranty Period	10 years

Pattern No.	Color	Contract Price	Lead Time
Ready-To-Ship US Warehouse			
MCONLMSL-M4586128	Re-wool I28/Black	USD 3,565.00	-
MCONLMSL-M244912	Clay I2/Black	USD 3,880.00	-
Extras			
MLEAKIT	Leather care set for Refine Leather	USD 27.00	-

CONNECT SOFT MODULAR SOFA / RIGHT ARMREST CHAISE LOUNGE (H)

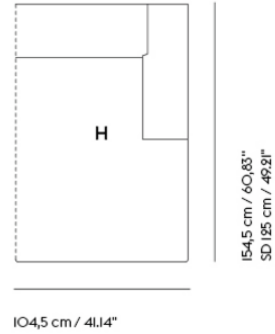

Shipper Colli	1
Gross Weight (kg)	67,2
Net Weight (kg)	52,1
Please note	This product features an armrest on the right-hand side when facing the product from the front.
Warranty Period	10 years

Pattern No.	Color	Contract Price	Lead Time
Ready-To-Ship US Warehouse			
MCONLMSR-M4586128	Re-wool 128/Black	USD 3,565.00	-
MCONLMSR-M244912	Clay 12/Black	USD 3,880.00	-
Extras			
MLEAKIT	Leather care set for Refine Leather	USD 27.00	-

CONNECT SOFT MODULAR SOFA / OTTOMAN (I)

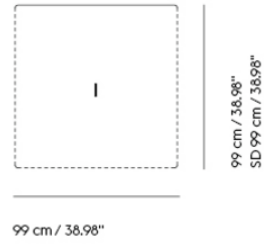

Shipper Colli I
Gross Weight (kg) 35.29
Net Weight (kg) 25.69
Warranty Period 10 years

Pattern No.	Color	Contract Price	Lead Time
Ready-To-Ship US Warehouse			
MCONOTTSS-M4586128	Re-wool I28 ***	USD 1,836.00	-
MCONOTTSS-M244912	Clay I2	USD 2,095.00	-
Extras			
MLEAKIT	Leather care set for Refine Leather	USD 27.00	-

CONNECT SOFT MODULAR SOFA / 2-SEATER - CONFIGURATION I

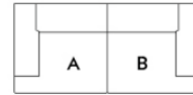

207 cm / 81.5"

99 cm / 38.98"
SD 66 cm / 25.98"

Shipper Colli 2
Gross Weight (kg) 100
Net Weight (kg) 76.6
Warranty Period 10 years

Pattern No.	Color	Contract Price	Lead Time
Ready-To-Ship US Warehouse			
MCONSPS2C1-M4586128	Re-wool I28	USD 5,406.00	-
MCONSPS2C1-M244912	Clay I2	USD 5,770.00	-

CONNECT SOFT MODULAR SOFA / 2-SEATER - CONFIGURATION 2

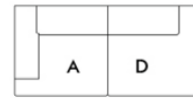

99 cm / 38.98"
SD 66 cm / 25.98"

207 cm / 81.5"

Shipper Colli 2
Gross Weight (kg) 96
Net Weight (kg) 72.6
Warranty Period 10 years

Pattern No.	Color	Contract Price	Lead Time
Ready-To-Ship US Warehouse			
MCONSPS2C2-M4586128	Re-wool I28	USD 5,140.00	-
MCONSPS2C2-M244912	Clay I2	USD 5,511.00	-

CONNECT SOFT MODULAR SOFA / 2-SEATER - CONFIGURATION 3

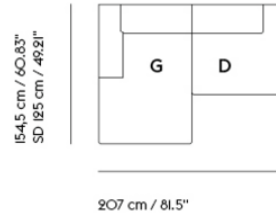
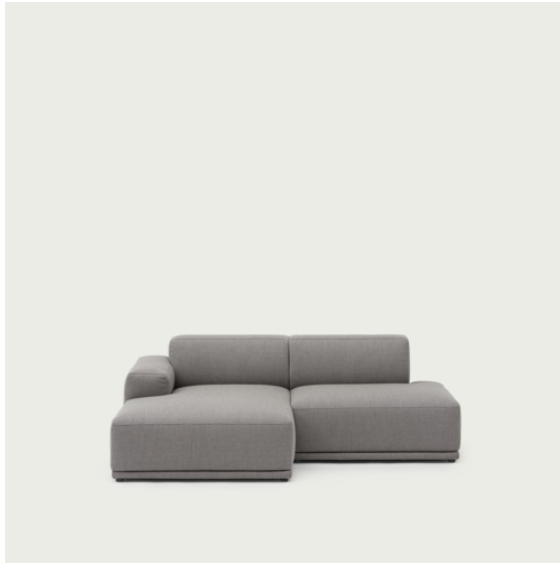

Shipper Colli 2
Gross Weight (kg) 113.2
Net Weight (kg) 86.4
Warranty Period 10 years

Pattern No.	Color	Contract Price	Lead Time
Ready-To-Ship US Warehouse			
MCONSPS2C3-M4586128	Re-wool 128	USD 5,875.00	-
MCONSPS2C3-M244912	Clay 12	USD 6,505.00	-

CONNECT SOFT MODULAR SOFA / 3-SEATER - CONFIGURATION I



99 cm / 38.98"
SD 66 cm / 25.98"

288 cm / 113.39"

Shipper Colli 3
Gross Weight (kg) 142
Net Weight (kg) 109
Warranty Period 10 years

Pattern No.	Color	Contract Price	Lead Time
Ready-To-Ship US Warehouse			
MCONSPS3C1-M4586128	Re-wool 128	USD 7,506.00	-
MCONSPS3C1-M244912	Clay 12	USD 8,241.00	-

CONNECT SOFT MODULAR SOFA / 3-SEATER - CONFIGURATION 2

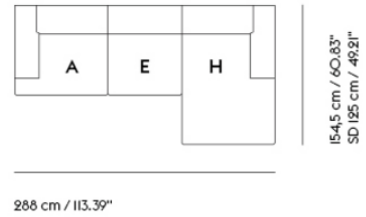

Shipper Colli 3
Gross Weight (kg) 159.2
Net Weight (kg) 122.8
Warranty Period 10 years

Pattern No.	Color	Contract Price	Lead Time
Ready-To-Ship US Warehouse			
MCONSPS3C2-M4586128	Re-wool 128	USD 8,290.00	-
MCONSPS3C2-M244912	Clay 12	USD 9,081.00	-

CONNECT SOFT MODULAR SOFA / 3-SEATER - CONFIGURATION 3

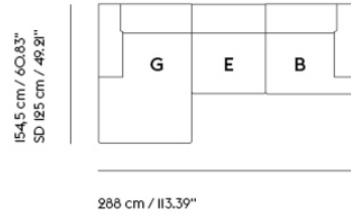

Shipper Colli 3
 Gross Weight (kg) 159.2
 Net Weight (kg) 122.8
 Warranty Period 10 years

Pattern No.	Color	Contract Price	Lead Time
Ready-To-Ship US Warehouse			
MCONSPS3C3-M4586128	Re-wool 128	USD 8,290.00	-
MCONSPS3C3-M244912	Clay 12	USD 9,081.00	-

CONNECT SOFT MODULAR SOFA / CORNER - CONFIGURATION I

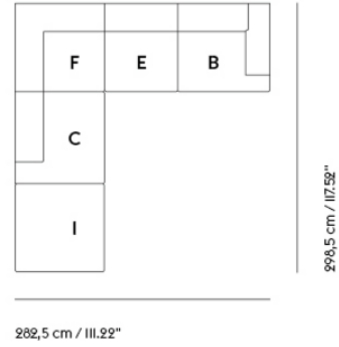

Shipper Colli 5
 Gross Weight (kg) 224.09
 Net Weight (kg) 169.99
 Warranty Period 10 years

Pattern No.	Color	Contract Price	Lead Time
Ready-To-Ship US Warehouse			
MCONSPSCC1-M4586128	Re-wool 128	USD 11,545.00	-
MCONSPSCC1-M244912	Clay 12	USD 13,120.00	-

CONNECT SOFT MODULAR SOFA / CORNER - CONFIGURATION 2

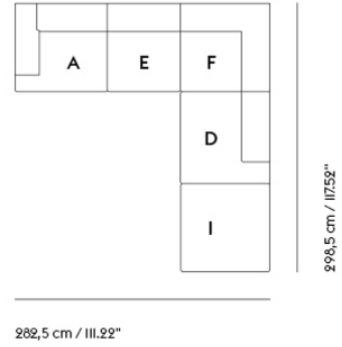

Shipper Colli 5
Gross Weight (kg) 224.09
Net Weight (kg) 169.99
Warranty Period 10 years

Pattern No.	Color	Contract Price	Lead Time
Ready-To-Ship US Warehouse			
MCONSPSCC2-M4586128	Re-wool I28	USD 11,545.00	-
MCONSPSCC2-M244912	Clay I2	USD 13,120.00	-

CONNECT SOFT MODULAR SOFA / CORNER - CONFIGURATION 3

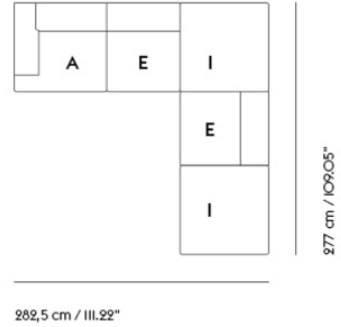

Shipper Colli 5
Gross Weight (kg) 204.58
Net Weight (kg) 154.48
Warranty Period 10 years

Pattern No.	Color	Contract Price	Lead Time
Ready-To-Ship US Warehouse			
MCONSPSCC3-M4586128	Re-wool I28	USD 10,390.00	-
MCONSPSCC3-M244912	Clay I2	USD 12,070.00	-

CONNECT SOFT MODULAR SOFA CUSHION



Shipper Colli 1
Gross Weight (kg) 1.3
Net Weight (kg) 0.1
Warranty Period 5 Years

Pattern No.	Color	Contract Price	Lead Time
Ready-To-Ship US Warehouse			
MCONSCUS2510-M4586128	Re-wool I28 ***	USD 257.00	-
MCONSCUS2510-M244912	Clay I2	USD 289.00	-
Extras			
MLEAKIT	Leather care set for Refine Leather	USD 27.00	-

CONNECT SOFT MODULAR SOFA SERIES

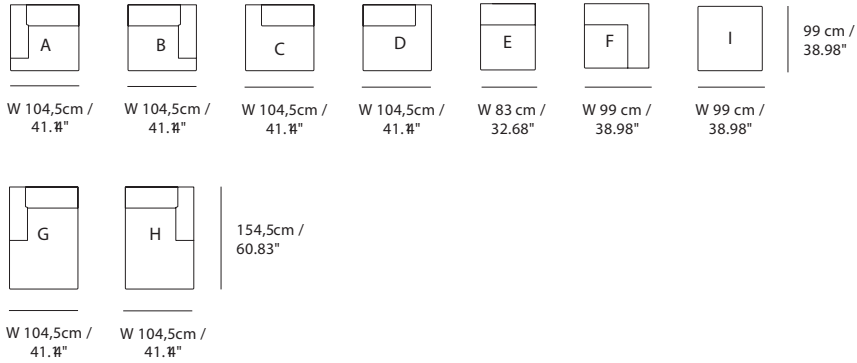

Shipper Colli 1
 Directional Modules Right and left refers to the side when facing the product from the front.
 Warranty Period 10 years

All Variants

Modules	Pattern No.	Weight (kg)	Contract Price Upholstery Grades								
			A	B	C	E	R	T	U	V	W
Left Armrest (A)	M-CONAMS-L	39	2,305	2,781	2,830	2,886	3,565	4,356	4,671	5,301	5,826
Right Armrest (B)	M-CONAMS-R	39	2,305	2,781	2,830	2,886	3,565	4,356	4,671	5,301	5,826
Center (E)	M-CONCMSS	33	2,046	2,256	2,361	2,515	2,830	3,411	3,726	4,146	4,615
Corner (F)	M-CONCS	40	2,305	2,571	2,781	2,886	3,565	4,356	4,671	5,301	5,826
Left Open-ended (C)	M-CONOMS-L	35	2,305	2,515	2,571	2,620	3,306	3,985	4,251	4,881	5,301
Right Open-Ended (D)	M-CONOMS-R	35	2,305	2,515	2,571	2,620	3,306	3,985	4,251	4,881	5,301
Ottoman (I)	M-CONOTTSS	26	1,570	1,731	2,046	2,095	2,515	2,886	3,096	3,565	3,880
Left Armrest Lounge (G)	M-CONLMS-L	53	3,096	3,565	3,621	3,880	4,615	5,560	6,036	6,820	7,450
Right Armrest Lounge (H)	M-CONLMS-R	53	3,096	3,565	3,621	3,880	4,615	5,560	6,036	6,820	7,450
Cushion	MCONSCUS-2510		198	257	278	289	268	362	394	450	503

HOW TO CONFIGURE

ORDER CODE EXAMPLE

Connect Soft Sofa Specify:	Connect soft sofa - A + D + B in Re-Wool 128 Modules	Connect A + D + B
Step 1) Choose modules	Textile	Re-Wool
Step 2) Choose Textile	Textile Color	128
Step 3) Choose Textile color	Final Pattern No.s (one per module)	M4586 128 MCONAMSL-M4586128 MCONOMS-R-M4586128 MCONAMSR-M4586128

Upholstery Options

A	B	C	E	R	T	U	V	W
Ocean (M161)* Remix (M156) Vancouver (M148)	Beck (M6376) Canvas (M153) Clara (M154) Fiord (M155) Grain (M12659) Manner (M12665) Re-Wool (M4586) Sabi (M8404) Steelcut (M149) Steelcut Trio (M139)	Hallingdal (M146)	Acca (M12660) Divina (M150) Divina MD (M147) Divina Melange (M135) Ecriture (M10767) Hearth (M12664) Twill Weave (M142) Vidar (M158)	Easy Leather (M141)	Refine Leather (M136)	Endure Leather (M137)	Grace Leather (M12374)	Allure Leather (M12375)

*Notes:
 Ocean: Color 3, 21, 32, 50, 52, 80 & 601
 Clay - Color 1, 2, 3, 4, 5, 6, 7, 8, 9, 10, 11, 12, 13, 14, 15, 16 & 17

COUPLE COFFEE TABLE

FOR MORE INFORMATION,
EXPLORE BELOW

- ↗ [Product Fact Sheet](#)
- ↗ [Images](#)
- ↗ [Architect Files](#)
- ↗ [Assembly Instructions](#)
- ↗ [Product Declaration](#)

The Couple Coffee Table Series consists of 3 wooden frame sizes and 2 types of ceramic stoneware tiles available in a selection of finishes. We have defined 36 variants for your convenience. Follow the steps below to find the one that suits your needs, and explore the 36 possible variants in the overview.

Visit muuto.com/products/shop-by-family/couple-coffee-table to get inspired and learn more about the design.

1. SIZE

Choose your preferred table size among three sizes.

120 x 84 x 35 cm

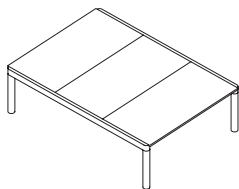

35 cm / 13.7"

120 cm / 47.2" 84 cm / 33.2"

80 x 84 x 40 cm

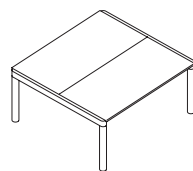

40 cm / 15.7"

80 cm / 31.5" 84 cm / 33.2"

40 x 84 x 40 cm

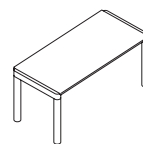

40 cm / 15.7"

40 cm 84 cm / 33.2" / 15.7"

2. TILE COMBINATIONS

Choose your preferred tabletop surface—with a fully plain surface or with a mix of Plain and Wavy tiles.

Note
Please note that there is a maximum of one Wavy tile per table on the 120x84x35 cm and 80x84x40 cm variant.

Tile Surfaces

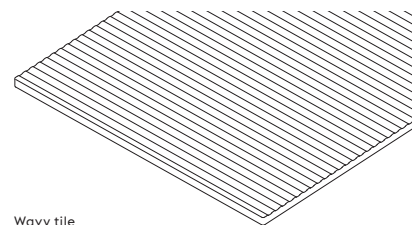
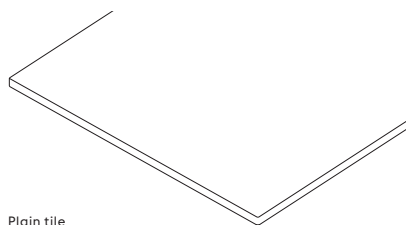

Combinations

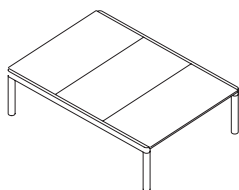

3 Plain

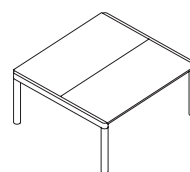

2 Plain

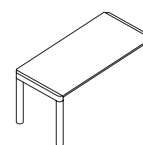

1 Plain

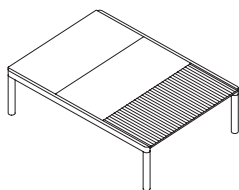

2 Plain 1 Wavy

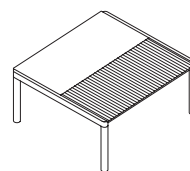

1 Plain 1 Wavy

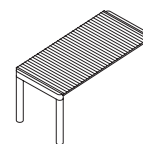

1 Wavy

3. FINISHES & COLORS

Select your preferred finish among 6 color combinations. Discover all 36 variants in the overview.

Note
Please note that the tile colors cannot be mixed.

Tabletop / Frame



Sand / Oak



Sand / Dark Oiled Oak



Pale Blue / Oak



Pale Blue / Dark Oiled Oak



Taupe / Oak



Taupe / Dark Oiled Oak



Sand /
Oak

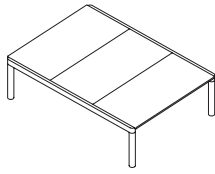

3 Plain

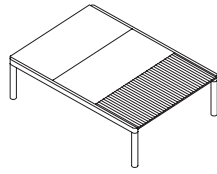

2 Plain 1 Wavy

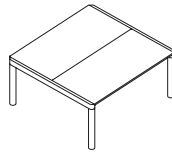

2 Plain

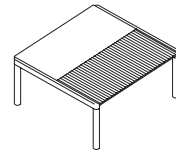

1 Plain 1 Wavy

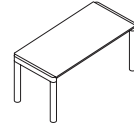

1 Plain

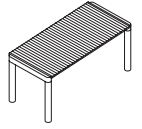

1 Wavy



Sand /
Dark Oiled
Oak

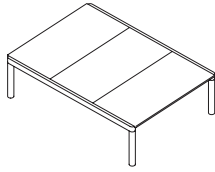

3 Plain

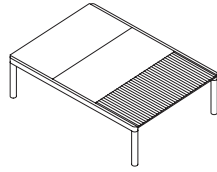

2 Plain 1 Wavy

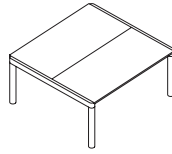

2 Plain

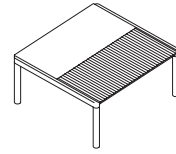

1 Plain 1 Wavy

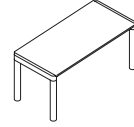

1 Plain

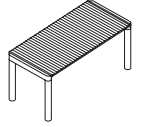

1 Wavy



Pale Blue /
Oak

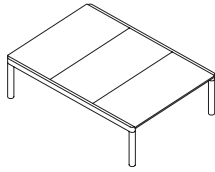

3 Plain

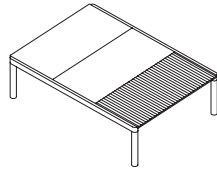

2 Plain 1 Wavy

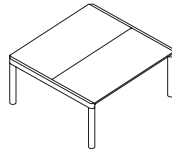

2 Plain

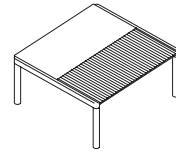

1 Plain 1 Wavy

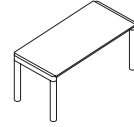

1 Plain

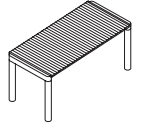

1 Wavy



Pale Blue /
Dark Oiled
Oak

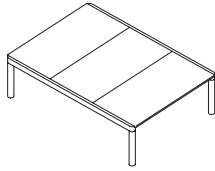

3 Plain

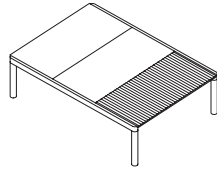

2 Plain 1 Wavy

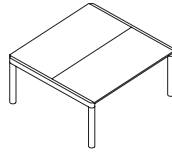

2 Plain

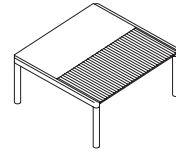

1 Plain 1 Wavy

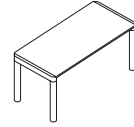

1 Plain

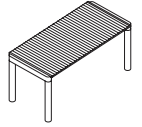

1 Wavy



Taupe /
Oak

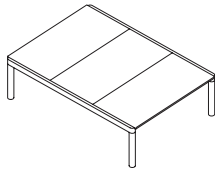

3 Plain

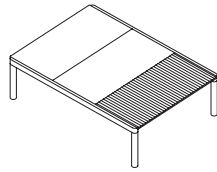

2 Plain 1 Wavy

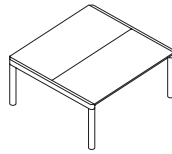

2 Plain

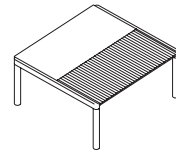

1 Plain 1 Wavy

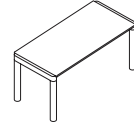

1 Plain

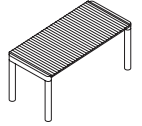

1 Wavy



Taupe /
Dark Oiled
Oak

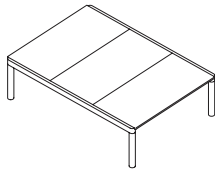

3 Plain

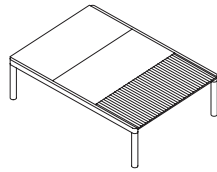

2 Plain 1 Wavy

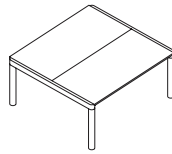

2 Plain

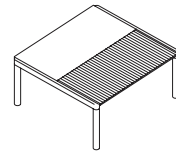

1 Plain 1 Wavy

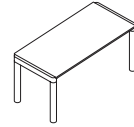

1 Plain

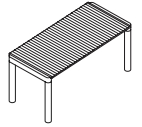

1 Wavy

**COUPLE COFFEE TABLE / 40 X 84 X 40
CM / 15.7 X 33.2 X 15.7"**

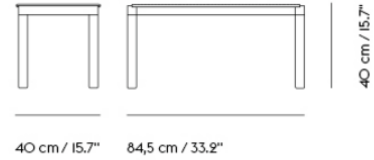

Shipper Colli 2
 Gross Weight (kg) 16.24
 Net Weight (kg) 13.86
 Warranty 10 years

Pattern No.	Color	Contract Price	Lead Time
Ready-To-Ship US Warehouse			
MCOUP1PL-PABU-DOAK	1 Plain - Pale Blue/Dark Oiled Oak ***	USD 929.00	-
MCOUP1PL-PABU-OAK	1 Plain - Pale Blue/Oak ***	USD 929.00	-
MCOUP1PL-SAND-DOAK	1 Plain - Sand/Dark Oiled Oak	USD 929.00	-
MCOUP1PL-SAND-OAK	1 Plain - Sand/Oak	USD 929.00	-
MCOUP1PL-TAUP-DOAK	1 Plain - Taupe/Dark Oiled Oak	USD 929.00	-
MCOUP1PL-TAUP-OAK	1 Plain - Taupe/Oak	USD 929.00	-
MCOUP1WV-LTBU-DOAK	1 Wavy - Light Blue/Dark Oiled Oak	USD 929.00	-
MCOUP1WV-LTBU-OAK	1 Wavy - Light Blue/Oak	USD 929.00	-
MCOUP1WV-SAND-DOAK	1 Wavy - Sand/Dark Oiled Oak	USD 929.00	-
MCOUP1WV-SAND-OAK	1 Wavy - Sand/Oak	USD 929.00	-
MCOUP1WV-TAUP-DOAK	1 Wavy - Taupe/Dark Oiled Oak	USD 929.00	-
MCOUP1WV-TAUP-OAK	1 Wavy - Taupe/Oak	USD 929.00	-

COUPLE COFFEE TABLE / 80 X 84 X 40 CM / 31.5 X 33.2 X 15.7"

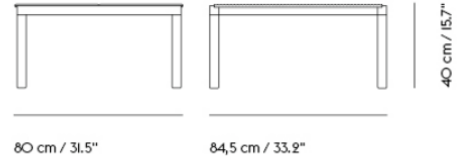

Shipper Colli	3
Gross Weight (kg)	29.78
Net Weight (kg)	25.52
Warranty	10 years

Pattern No.	Color	Contract Price	Lead Time
Ready-To-Ship US Warehouse			
MCOUP2PW-LTBU-DOAK	1 Plain 1 Wavy - Light Blue/Dark Oiled Oak	USD 1,360.00	-
MCOUP2PW-LTBU-OAK	1 Plain 1 Wavy - Light Blue/Oak	USD 1,360.00	-
MCOUP2PW-SAND-DOAK	1 Plain 1 Wavy - Sand/Dark Oiled Oak	USD 1,360.00	-
MCOUP2PW-SAND-OAK	1 Plain 1 Wavy - Sand/Oak	USD 1,360.00	-
MCOUP2PW-TAUP-DOAK	1 Plain 1 Wavy - Taupe/Dark Oiled Oak	USD 1,360.00	-
MCOUP2PW-TAUP-OAK	1 Plain 1 Wavy - Taupe/Oak	USD 1,360.00	-
MCOUP2PL-PABU-DOAK	2 Plain - Pale Blue/Dark Oiled Oak ***	USD 1,360.00	-
MCOUP2PL-PABU-OAK	2 Plain - Pale Blue/Oak ***	USD 1,360.00	-
MCOUP2PL-SAND-DOAK	2 Plain - Sand/Dark Oiled Oak	USD 1,360.00	-
MCOUP2PL-SAND-OAK	2 Plain - Sand/Oak	USD 1,360.00	-
MCOUP2PL-TAUP-DOAK	2 Plain - Taupe/Dark Oiled Oak	USD 1,360.00	-
MCOUP2PL-TAUP-OAK	2 Plain - Taupe/Oak	USD 1,360.00	-

COUPLE COFFEE TABLE / 120 X 84 X 35 CM / 47.2 X 33.2 X 13.7"

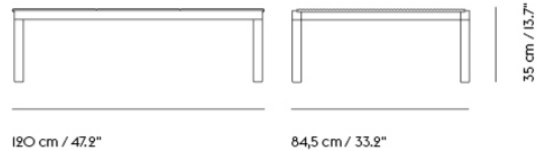

Shipper Colli	4
Gross Weight (kg)	42.42
Net Weight (kg)	36.28
Warranty	10 years

Pattern No.	Color	Contract Price	Lead Time
Ready-To-Ship US Warehouse			
MCOUP3PW-LTBU-DOAK	2 Plain Wavy - Light Blue/Dark Oiled Oak	USD 1,731.00	-
MCOUP3PW-LTBU-OAK	2 Plain Wavy - Light Blue/Oak	USD 1,731.00	-
MCOUP3PW-SAND-DOAK	2 Plain Wavy - Sand/Dark Oiled Oak	USD 1,731.00	-
MCOUP3PW-SAND-OAK	2 Plain Wavy - Sand/Oak	USD 1,731.00	-
MCOUP3PW-TAUP-DOAK	2 Plain Wavy - Taupe/Dark Oiled Oak	USD 1,731.00	-
MCOUP3PW-TAUP-OAK	2 Plain Wavy - Taupe/Oak	USD 1,731.00	-
MCOUP3PL-PABU-DOAK	3 Plain - Pale Blue/Dark Oiled Oak ***	USD 1,731.00	-
MCOUP3PL-PABU-OAK	3 Plain - Pale Blue/Oak ***	USD 1,731.00	-
MCOUP3PL-SAND-DOAK	3 Plain - Sand/Dark Oiled Oak	USD 1,731.00	-
MCOUP3PL-SAND-OAK	3 Plain - Sand/Oak	USD 1,731.00	-
MCOUP3PL-TAUP-DOAK	3 Plain - Taupe/Dark Oiled Oak	USD 1,731.00	-
MCOUP3PL-TAUP-OAK	3 Plain - Taupe/Oak	USD 1,731.00	-

COVER CHAIR SERIES

FOR MORE INFORMATION,
EXPLORE BELOW

- ↗ [Product Fact Sheet](#)
- ↗ [Images](#)
- ↗ [Architect Files](#)
- ↗ [Assembly Instructions](#)
- ↗ [Product Declaration](#)
- ↗ [Product Configurator](#)

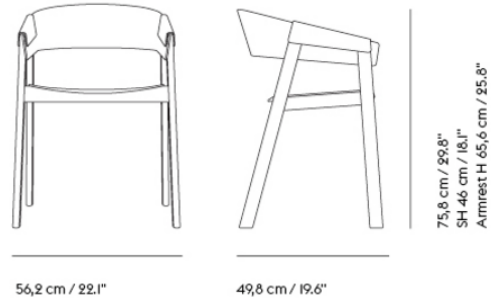

Shipper Colli	1
Gross Weight (kg)	6.9
Net Weight (kg)	5
Base color options	Black, Dark Beige, Green, Oak or Stained Dark Brown
Warranty Period	10 years

Pattern No.	Color	Contract Price	Lead Time
Ready-To-Ship US Warehouse			
MCVRAW-BLCK	Black	USD 667.00	-
MCVRAW-DKBE	Dark Beige	USD 667.00	-
MCVRAW-OAK	Oak	USD 667.00	-
MCVRAW-STDB	Stained Dark Brown	USD 667.00	-
MCVRAU-BLCK-M136BLCK	Refine Leather Black/Black ***	USD 933.00	-
MCVRAU-OAK-M136COGN	Refine Leather Cognac/Oak	USD 933.00	-
MCVRAU-DKBE-M136STON	Refine Leather Stone/Dark Beige ***	USD 933.00	-

Ready-To-Ship EU Warehouse

MCVRAW-GREN	Green	USD 667.00	-
-------------	-------	------------	---

Extras

MGLDCVSFT4	Felt Glides for the Cover Series (4 pcs per pack) - White	USD 21.00	-
MGLDCVSPT4	Plastic glides for the Cover Series (4 pcs per pack) - White	USD 21.00	-
MLEAKIT	Leather care set for Refine Leather	USD 27.00	-

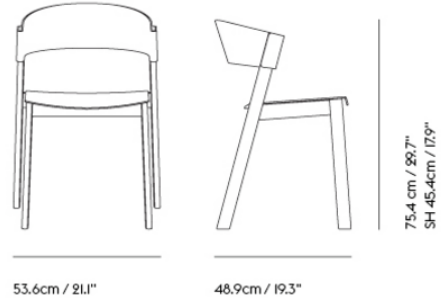

Shipper Colli	1
Gross Weight (kg)	10.3
Net Weight (kg)	4.2
Base color options	Black, Dark Beige, Green, Oak or Stained Dark Brown
Stacking information	Cover Side Chair stacks up to 4 chairs on floor and 10 chairs on the Cover Transport Trolley.
Warranty Period	10 years

Pattern No.	Color	Contract Price	Lead Time
Ready-To-Ship US Warehouse			
MCVRSW-BLCK	Black	USD 667.00	-
MCVRSW-DKBE	Dark Beige	USD 667.00	-
MCVRSW-OAK	Oak	USD 667.00	-
MCVRSW-STDB	Stained Dark Brown ***	USD 667.00	-
MCVRSU-BLCK-M136BLCK	Refine Leather Black/Black	USD 933.00	-
MCVRSU-STDB-M136BLCK	Refine Leather Black/Stained Dark Brown	USD 933.00	-
MCVRSU-OAK-M136COGN	Refine Leather Cognac/Oak	USD 933.00	-
MCVRSU-DKBE-M136STON	Refine Leather Stone/Dark Beige	USD 933.00	-
Ready-To-Ship EU Warehouse			
MCVRSW-GREN	Green	USD 667.00	-
Extras			
MGLDCVSFT4	Felt Glides for the Cover Series (4 pcs per pack) - White	USD 21.00	-
MGLDCVSPT4	Plastic glides for the Cover Series (4 pcs per pack) - White	USD 21.00	-
MLEAKIT	Leather care set for Refine Leather	USD 27.00	-

COVER AND VISU CHAIR TRANSPORT TROLLEY

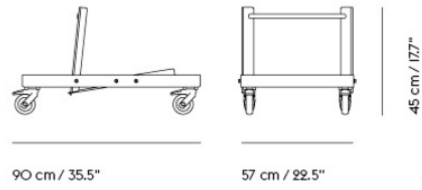

Shipper Colli	1
Gross Weight (kg)	22
Net Weight (kg)	21.5
Please note	This transport trolley can be used for Visu Chair Tube Base, Visu Chair Sled Base and Cover Side Chair.
Stacking information	Cover Side Chair (10 pcs.) / Visu Chair Sled Base (17 pcs.) / Visu Chair Tube Base (17 pcs.) / Visu Chair Sled Base w. Upholstery (15 pcs.) / Visu Chair Tube Base w. Upholstery (15 pcs)
Warranty Period	5 years

Pattern No.	Color	Contract Price	Lead Time
Ready-To-Ship US Warehouse			
MTTCV	Black	USD 971.00	-

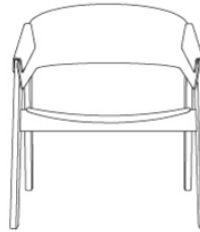

66,3 cm / 26.1"



61,2 cm / 24.1"

70,7 cm / 27.8"
SH 38,1 cm / 15"

Shipper Colli	1
Gross Weight (kg)	9.423
Net Weight (kg)	7.5
Base color options	Black or Oak
Warranty Period	10 years

Pattern No.	Color	Contract Price	Lead Time
Ready-To-Ship US Warehouse			
MCVRLW-BLCK	Black - PU Lacquer ***	USD 1,206.00	-
MCVRLW-OAK	Oak - PU Lacquer	USD 1,206.00	-
MCVRLU-BLCK-M136BLCK	Refine Leather Black/Black	USD 1,675.00	-
MCVRLU-STDB-M136BLCK	Refine Leather Black/Stained Dark Brown	USD 1,675.00	-
MCVRLU-OAK-M136COGN	Refine Leather Cognac/Oak	USD 1,675.00	-
Extras			
MGLDCVSFT4	Felt Glides for the Cover Series (4 pcs per pack) - White	USD 21.00	-
MGLDCVSPT4	Plastic glides for the Cover Series (4 pcs per pack) - White	USD 21.00	-
MLEAKIT	Leather care set for Refine Leather	USD 27.00	-

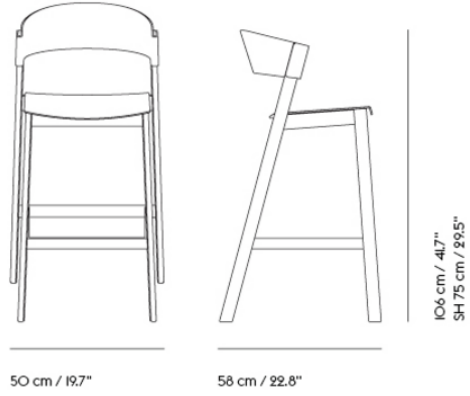

Shipper Colli	1
Gross Weight (kg)	9.15
Net Weight (kg)	6.25
Base color options	Black or Oak
Warranty Period	10 Years

Pattern No.	Color	Contract Price	Lead Time
-------------	-------	----------------	-----------

Ready-To-Ship US Warehouse

MCVRSTBW-BLCK	Black	USD 1,003.00	-
MCVRSTBW-OAK	Oak	USD 1,003.00	-
MCVRSTBU-BLCK-M136BLCK	Refine Leather Black/Black	USD 1,311.00	-
MCVRSTBU-OAK-M136COGN	Refine Leather Cognac/Oak	USD 1,311.00	-

Ready-To-Ship EU Warehouse

MCVRSTBW-GREN	Green	USD 1,003.00	-
MCVRSTBW-STDB	Stained Dark Brown ***	USD 1,003.00	-

Extras

MGLDCVSFT4	Felt Glides for the Cover Series (4 pcs per pack) - White	USD 21.00	-
MGLDCVSPT4	Plastic glides for the Cover Series (4 pcs per pack) - White	USD 21.00	-
MLEAKIT	Leather care set for Refine Leather	USD 27.00	-
MFRSTC	Steel Footrest Protector - Self-Mounting	USD 39.00	-

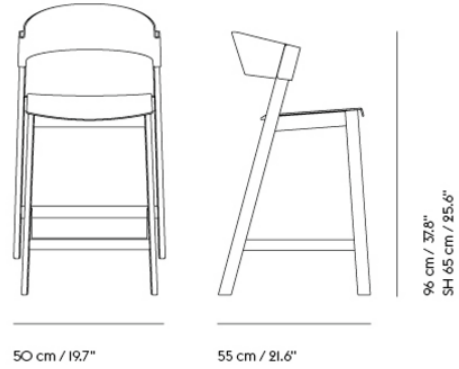

Shipper Colli	1
Gross Weight (kg)	8.75
Net Weight (kg)	5.85
Base color options	Black or Oak
Warranty Period	10 Years

Pattern No.	Color	Contract Price	Lead Time
Ready-To-Ship US Warehouse			
MCVRSTCW-BLCK	Black	USD 1,003.00	-
MCVRSTCW-DKBE	Dark Beige ***	USD 1,003.00	-
MCVRSTCW-OAK	Oak	USD 1,003.00	-
MCVRSTCW-STDB	Stained Dark Brown ***	USD 1,003.00	-
MCVRSTCU-BLCK-M136BLCK	Refine Leather Black/Black ***	USD 1,311.00	-
MCVRSTCU-STDB-M136BLCK	Refine Leather Black/Stained Dark Brown	USD 1,311.00	-
MCVRSTCU-OAK-M136COGN	Refine Leather Cognac/Oak	USD 1,311.00	-
Ready-To-Ship EU Warehouse			
MCVRSTCW-GREN	Green	USD 1,003.00	-
MCVRSTCW-MBLU	Midnight Blue ***	USD 1,003.00	-
Extras			
MGLDCVSFT4	Felt Glides for the Cover Series (4 pcs per pack) - White	USD 21.00	-
MGLDCVSPT4	Plastic glides for the Cover Series (4 pcs per pack) - White	USD 21.00	-
MLEAKIT	Leather care set for Refine Leather	USD 27.00	-
MFTRSTC	Steel Footrest Protector - Self-Mounting	USD 39.00	-

COVER CHAIR SERIES



All Variants

Description	Pattern No.	Wood Seat	Contract Price										
			Upholstery Grades										
			COM		CIL		COL						
A	B	C	E	R	T	U	V	W					
Cover Armchair	Wood Seat	M-CVRA-W	667										
	Upholstered Seat	M-CVRA-U		803	845	866	898	919	933	971	1,034	1,101	
Cover Side Chair	Wood Seat	M-CVRS-W	667										
	Upholstered Seat	M-CVRS-U		803	845	856	898	919	933	971	1,034	1,101	
Cover Lounge Chair	Wood Seat	M-CVRL-W	1,206										
	Upholstered Seat	M-CVRL-U		1,465	1,626	1,675	1,626	1,675	1,675	1,731	1,626	1,836	

HOW TO CONFIGURE

ORDER CODE EXAMPLE:

Cover Armchair

Cover Armchair Oak / Steelcut Trio 226

Specify:

- Step 1) Choose variant
- Step 2) Choose wood frame finish option
- Step 3) Choose upholstery
- Step 4) Choose upholstery color

Variant	Cover Armchair Upholstered Seat	MCVRAU
Finish/color	Oak	OAK
Upholstery	Steelcut Trio	M139
Upholstery Color	226	226
Final Pattern No:	MCVRAUOAKM139226	

Wood Frame - Finish Options

- BLCK - Black
- DKBE - Dark Beige
- GREN - Green (only Armchair & Side Chair)
- OAK - Oak

Upholstery Options

A	B	C	E	R	T	U	V	W
Ocean (M161)* Remix (M156)	Beck (M6376) Canvas (M153) Clara (M154) Fiord (M155) Grain (M12659) Manner (M12665) Re-Wool (M4586) Sabi (M8404) Steelcut (M149) SteelCut Trio (M139)	Hallingdal (M146)	Acca (M12660) Divina (M150) Divina MD (M147) Divina Melange (M135) Ecriture (M10767) Hearth (M12664) Twill Weave (M142) Vidar (M158)	Easy Leather (M141)	Refine Leather (M136)	Endure	Grace Leather (M12374)	Allure Leather

*Notes:
Ocean - Color 3, 21, 32, 50, 52, 80 & 601

COVER STOOL



All Variants

Description	Pattern No.	Wood Seat	Contract Price	Upholstery Grades								
				A	COM		CIL		COL			
				A	B	C	E	R	T	U	V	W
Cover Bar Stool	Wood Seat	M-CVRSTB-W	1,003									
	Upholstered Seat	M-CVRSTB-U		1,150	1,206	1,255	1,206	1,255	1,311	1,360	1,416	1,416
Cover Counter Stool	Wood Seat	M-CVRSTC-W	1,003									
	Upholstered Seat	M-CVRSTC-U		1,150	1,206	1,255	1,255	1,255	1,311	1,360	1,416	1,416
Cover Bar Stool w. footrest	Wood Seat	M-CVRSTB-WF	1,045									
	Upholstered Seat	M-CVRSTB-UF		1,206	1,255	1,255	1,311	1,311	1,360	1,416	1,465	1,465
Cover Counter Stool w. footrest	Wood Seat	M-CVRSTC-WF	1,045									
	Upholstered Seat	M-CVRSTC-UF		1,206	1,255	1,255	1,311	1,311	1,360	1,416	1,465	1,465

HOW TO CONFIGURE

ORDER CODE EXAMPLE:

Cover Counter Stool

Cover Counter Stool Oak / Steelcut Trio 226

Specify:

- Step 1) Choose variant
- Step 2) Choose wood frame finish option
- Step 3) Choose upholstery
- Step 4) Choose upholstery color

Variant	Cover Counter Stool Upholstered Seat	M-CVRSTCU
Finish/color	Oak	OAK
Upholstery	Steelcut Trio	M139
Upholstery Color	226	226
Final Pattern No:	M-CVRSTCUOKM139226	

Wood Frame - Finish Options

- BLCK - Black
- DKBE - Dark Beige
- GREN - Green
- OAK - Oak

Upholstery Options

A	B	C	E	R	T	U	V	W
Ocean (M161)* Remix (M156)	Beck (M6376) Canvas (M153) Clara (M154) Fiord (M155) Grain (M12659) Manner (M12665) Re-Wool (M4586) Sabi (M8404) Steelcut (M149) SteelCut Trio (M139)	Hallingdal (M146)	Acca (M12660) Divina (M150) Divina MD (M147) Divina Melange (M135) Ecriture (M10767) Hearth (M12664) Twill Weave (M142) Vidar (M158)	Easy Leather (M141)	Refine Leather (M136)	Endure	Grace Leather (M12374)	Allure Leather

*Notes:
Ocean - Color 3, 21, 32, 50, 52, 80 & 601

DOZE LOUNGE SERIES

FOR MORE INFORMATION,
EXPLORE BELOW

- ↗ [Product Fact Sheet](#)
- ↗ [Images](#)
- ↗ [Architect Files](#)
- ↗ [Product Declaration](#)
- ↗ [Product Configurator](#)

DOZE LOUNGE CHAIR HIGH BACK TUBE BASE

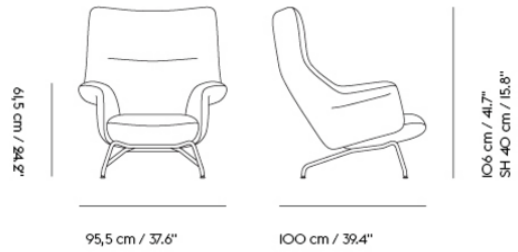

Shipper Colli	1
Gross Weight (kg)	45
Net Weight (kg)	40
Base color options	Anthracite Black, Chrome, Grey
Warranty Period	10 years

Pattern No.	Color	Contract Price	Lead Time
Ready-To-Ship US Warehouse			
MDOZLC-BLCK-M16180	Ocean 80/Anthracite Black	USD 3,096.00	-
MDOZLC-CHRO-M152782	Balder 782/Chrome	USD 3,775.00	-
MDOZLC-BLCK-M136COGN	Refine Leather Cognac/Anthracite Black	USD 4,615.00	-
Ready-To-Ship EU Warehouse			
MDOZLC-CHRO-M4586128	Re-Wool 128/Chrome	USD 3,411.00	-
Extras			
MGLDDLOFB4	Felt Glides for Doze Lounge Chair and Ottoman (4 pcs per pack)	USD 21.00	-
MLEAKIT	Leather care set for Refine Leather	USD 27.00	-

DOZE LOUNGE CHAIR LOW BACK TUBE BASE

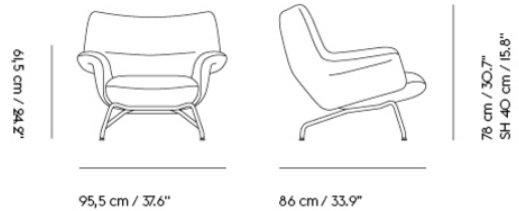

Shipper Colli	1
Gross Weight (kg)	45
Net Weight (kg)	40
Base color options	Anthracite Black, Chrome, Grey
Warranty Period	10 years

Pattern No.	Color	Contract Price	Lead Time
Ready-To-Ship US Warehouse			
MDOZLCLB-BLCK-M16180	Ocean 80/Anthracite Black	USD 2,571.00	-
MDOZLCLB-GREY-M1266407	Hearth 7/Grey	USD 3,096.00	-
Ready-To-Ship EU Warehouse			
MDOZLCLB-BLCK-M136COGN	Refine Leather Cognac/Anthracite Black	USD 3,355.00	-
Extras			
MGLDDLOFB4	Felt Glides for Doze Lounge Chair and Ottoman (4 pcs per pack)	USD 21.00	-
MLEAKIT	Leather care set for Refine Leather	USD 27.00	-

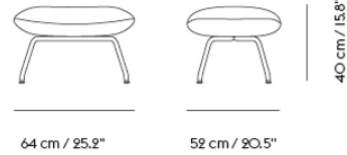
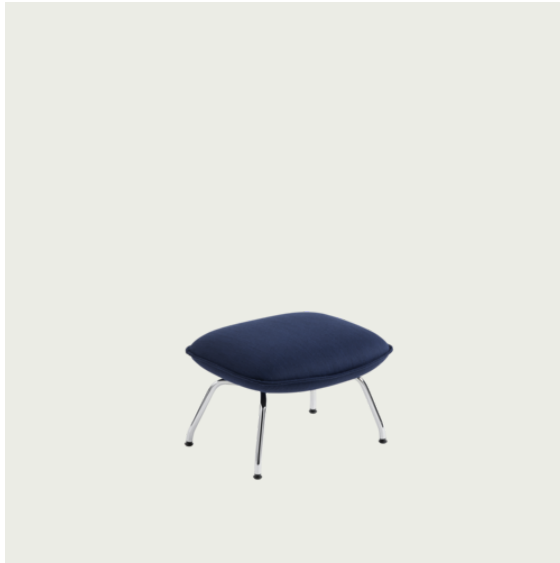

Shipper Colli	1
Gross Weight (kg)	20
Net Weight (kg)	18
Base color options	Anthracite Black, Chrome, Grey
Warranty Period	10 years

Pattern No.	Color	Contract Price	Lead Time
Ready-To-Ship US Warehouse			
MDOZOTT-BLCK-M16180	Ocean 80/Anthracite Black	USD 1,028.00	-
MDOZOTT-CHRO-M152782	Balder 782/Chrome	USD 1,311.00	-
MDOZOTT-BLCK-M136COGN	Refine Leather Cognac/Anthracite Black	USD 1,465.00	-
Ready-To-Ship EU Warehouse			
MDOZOTT-CHRO-M4586128	Re-Wool 128/Chrome	USD 1,150.00	-
Extras			
MGLDDLOFB4	Felt Glides for Doze Lounge Chair and Ottoman (4 pcs per pack)	USD 21.00	-
MLEAKIT	Leather care set for Refine Leather	USD 27.00	-

DOZE LOUNGE CHAIR HIGH BACK SWIVEL BASE

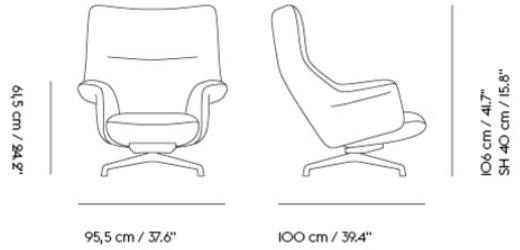

Shipper Colli	1
Gross Weight (kg)	45
Net Weight (kg)	40
Base color options	Anthracite Black, Grey or Polished Aluminum
Warranty Period	10 years

Pattern No.	Color	Contract Price	Lead Time
Ready-To-Ship US Warehouse			
MDOZLC-BLCK-M16180	Ocean 80/Anthracite Black	USD 3,411.00	-
MDOZLC-BLCK-M136COGN	Refine Leather Cognac/Anthracite Black	USD 4,881.00	-
Extras			
MGLDDLOFB4	Felt Glides for Doze Lounge Chair and Ottoman (4 pcs per pack)	USD 21.00	-
MLEAKIT	Leather care set for Refine Leather	USD 27.00	-

DOZE LOUNGE CHAIR LOW BACK SWIVEL BASE

100

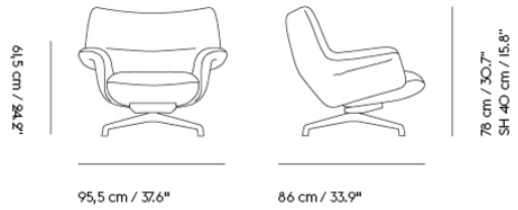

Shipper Colli	1
Gross Weight (kg)	45
Net Weight (kg)	40
Base color options	Anthracite Black, Grey or Polished Aluminum
Warranty Period	10 years

Pattern No.	Color	Contract Price	Lead Time
Ready-To-Ship US Warehouse			
MDOZLCLBSWB-BLCK-M16180	Ocean 80/Anthracite Black	USD 2,830.00	-
MDOZLCLBSWB-GREY-M1266407	Hearth 7/Grey	USD 3,355.00	-
Ready-To-Ship EU Warehouse			
MDOZLCLBSWB-BLCK-M136COGN	Refine Leather Cognac/Anthracite Black	USD 3,621.00	-
Extras			
MGLDDL0FB4	Felt Glides for Doze Lounge Chair and Ottoman (4 pcs per pack)	USD 21.00	-
MLEAKIT	Leather care set for Refine Leather	USD 27.00	-

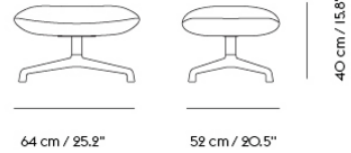
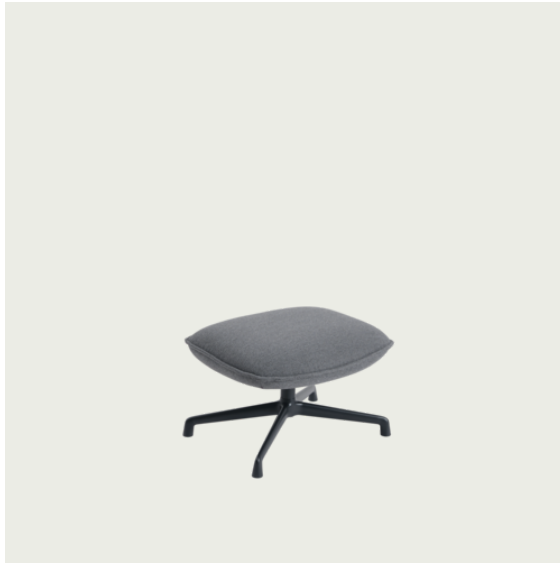

Shipper Colli	1
Gross Weight (kg)	20
Net Weight (kg)	18
Base color options	Anthracite Black, Grey or Polished Aluminum
Warranty Period	10 years

Pattern No.	Color	Contract Price	Lead Time
Ready-To-Ship US Warehouse			
MDOZOTTSWB-BLCK-M16180	Ocean 80/Anthracite Black	USD 1,311.00	-
MDOZOTTSWB-BLCK-M136COGN	Refine Leather Cognac/Anthracite Black	USD 1,731.00	-
Extras			
MGLDDLOFB4	Felt Glides for Doze Lounge Chair and Ottoman (4 pcs per pack)	USD 21.00	-
MLEAKIT	Leather care set for Refine Leather	USD 27.00	-

DOZE LOUNGE CHAIR & OTTOMAN



All Variants		Contract Price	Upholstery Grades							
			A	COM B	CIL C	E	R	COL T	U	V
Pattern No.										
Doze Lounge Chair High Back Tube Base	M-DOZLC	3,096	3,411	3,565	3,775	4,300	4,615	4,986	5,826	5,980
Doze Lounge Chair High Back Swivel Base	M-DOZLCSWB	3,411	3,621	3,831	4,090	4,405	4,881	5,511	6,085	6,246
Doze Lounge Chair Low Back Tube Base	M-DOZLCLB	2,571	2,830	2,830	3,096	3,201	3,355	3,880	4,146	4,510
Doze Lounge Chair Low Back Swivel Base	M-DOZLCLSWB	2,830	3,096	3,201	3,355	3,516	3,621	4,146	4,405	4,510
Doze Ottoman Tube Base	M-DOZOTT	1,028	1,150	1,255	1,311	1,416	1,465	1,731	1,836	1,885
Doze Ottoman Swivel Base	M-DOZOTTSWB	1,311	1,416	1,570	1,626	1,570	1,731	1,941	2,095	2,151

HOW TO CONFIGURE

ORDER CODE EXAMPLE

Doze Lounge Specify:

Doze Lounge Chair in Ocean 80 w/anthracite black base

- Step 1) Choose variant
- Step 2) Choose base color
- Step 3) Choose upholstery
- Step 4) Choose upholstery color

Variant: Doze Lounge
 Base Color: Anthracite Black
 Upholstery: Ocean
 Upholstery Color: 80
 Final Pattern No: MDOZLCBLCKM16180

MDOZLC
 BLCK
 M161
 80

Frame - Finish Options

- BLCK - Anthracite Black
- CHRO - Chrome (Only available on Tube Base)
- ALU - Polished Aluminum (Only available on Swivel Base)
- GREY - Grey

Upholstery Options

A	B	C	E	R	T	U	V	W
Ocean (M161)*	Beck (M6376) Clara (M154) Fiord (M155) Grain (M12659) Manner (M12665) Re-Wool (M4586) Sabi (M8404) Steelcut (M149) Steelcut Trio (M139)	Hallingdal (M146)	Acca (M12660) Balder (M152) Divina (M150) Divina MD (M147) Divina Melange (M135) Ecriture (M10767) Hearth (M12664) Twill Weave (M142) Vidar (M158)	Easy Leather (M141)	Refine Leather (M136)	Endure Leather (M137)	Grace Leather (M12374)	Allure Leather (M12375)

*Notes:
Ocean - Color 3, 21, 32, 50, 52, 80 & 601

EARNEST EXTENDABLE TABLE

FOR MORE INFORMATION,
EXPLORE BELOW

- ↗ [Product Fact Sheet](#)
- ↗ [Images](#)
- ↗ [Architect Files](#)
- ↗ [Assembly Instructions](#)
- ↗ [Product Declaration](#)

EARNEST EXTENDABLE TABLE / 205 X 100 CM / 80.75 X 39.5"

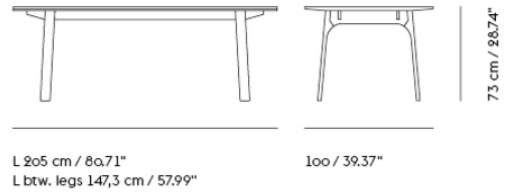

Shipper Colli	1
Gross Weight (kg)	73.6
Net Weight (kg)	62.045
Base color options	Oak, Dark Oiled Oak
Warranty Period	5 years

Pattern No.	Color	Contract Price	Lead Time
Ready-To-Ship US Warehouse			
MERNSTEXT8140-DOAK	Dark Oiled Oak	USD 5,350.00	-
MERNSTEXT8140-OAK	Oiled Oak	USD 5,350.00	-
Extras			
MERNSTEXTL-DOAK	Extension Leaves - Set of 2 - Dark Oiled Oak	USD 1,360.00	-
MERNSTEXTL-OAK	Extension Leaves - Set of 2 - Oiled Oak	USD 1,360.00	-

EARNST EXTENDABLE TABLE / 260 X 100 CM / 102.5 X 39.5"

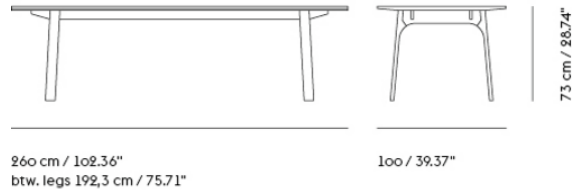

Shipper Colli	1
Gross Weight (kg)	90.4
Net Weight (kg)	71.845
Base color options	Oak, Dark Oiled Oak
Warranty Period	5 years

Pattern No.	Color	Contract Price	Lead Time
Ready-To-Ship US Warehouse			
MERNSTEXT10240-DOAK	Dark Oiled Oak	USD 6,715.00	-
MERNSTEXT10240-OAK	Oiled Oak	USD 6,715.00	-
Extras			
MERNSTEXTL-DOAK	Extension Leaves - Set of 2 - Dark Oiled Oak	USD 1,360.00	-
MERNSTEXTL-OAK	Extension Leaves - Set of 2 - Oiled Oak	USD 1,360.00	-

ECHO POUF

**FOR MORE INFORMATION,
EXPLORE BELOW**

- ↗ [Product Fact Sheet](#)
- ↗ [Images](#)
- ↗ [Architect Files](#)
- ↗ [Product Declaration](#)
- ↗ [Product Configurator](#)

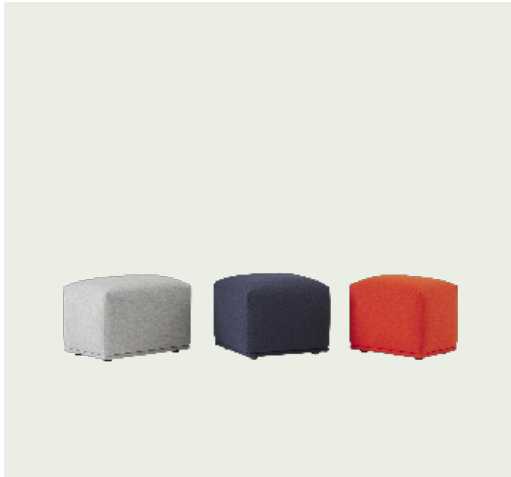

All Variants

		Contract Price			
		Upholstery Grades			
		COM			
Size	Pattern No.	A	B	C	E
38 X 52 CM / 15" x 20.5"	M-ECHOP-1521	755	954	1,013	1,024
42 X 62 CM / 16.5" x 24.4"	M-ECHOP-1725	919	1,024	1,101	1,150
52 X 52 CM / 20.5" x 20.5"	M-ECHOP-2121	828	992	1,024	1,045

HOW TO CONFIGURE

Echo pouf
Specify:
Step 1) Choose Size"
Step 2) Choose textile
Step 3) Choose textile color

ORDER CODE EXAMPLE

Echo pouf 15 x 20.5" in Ocean 80

Size 15 x 20.5"
Textile Ocean
Textile Color 80
Final Pattern No: MECHOP1521M16180

MECHOP1521
M161
80

Upholstery Options

A	B	C	E
Ocean (M161)* Remix (M156)	Beck (M6376) Cameo (K1443) Canvas (M153) Clara (M154) Fiord (M155) Grain (M12659) Manner (M12665) Steelcut (M149) Steelcut Trio (M139)	Hallingdal (M146)	Acca (M12660) Aegean (K2074) Clay (M2449)* Divina (M150) Divina MD (M147) Divina Melange (M135) Ecriture (M10767) Hearth (M12664) Highland (K2010) Twill Weave (M142) Vidar (M158)

*Notes:

Ocean - Color 3, 21, 32, 50, 52, 80 & 601

Clay - Color 1, 2, 3, 4, 5, 6, 7, 8, 9, 10, 11, 12, 13, 14, 15, 16 & 17

ENFOLD SIDEBOARD

FOR MORE INFORMATION,
EXPLORE BELOW

- ↗ Product Fact Sheet
- ↗ Images
- ↗ Architect Files
- ↗ Assembly Instructions
- ↗ Product Declaration

ENFOLD SIDEBOARD / 100 X 45 H: 85 CM / 39 X 17.7 H: 33.2"

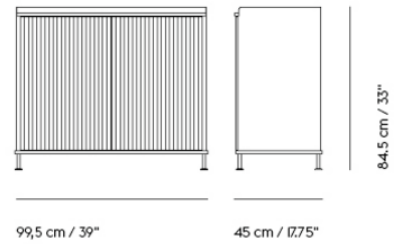

Shipper Colli	1
Gross Weight (kg)	54.16
Net Weight (kg)	41
Please note	This product includes 2 shelves. Up to 4 additional shelves can be added.
Warranty Period	10 years

Pattern No.	Color	Contract Price	Lead Time
Ready-To-Ship US Warehouse			
MENFSBT-BLCK-BLCK	Black/Anthracite Black	USD 2,676.00	-
MENFSBT-OAK-DGRN	Lacquered Oak/Dusty Green	USD 2,676.00	-
MENFSBT-OAK-GREY	Lacquered Oak/Grey	USD 2,676.00	-
MENFSBT-OAK-DPRD	Oiled Oak/Deep Red	USD 2,676.00	-
Ready-To-Ship EU Warehouse			
MENFSBT-OAK-BLCK	Lacquered Oak/Anthracite Black	USD 2,676.00	-
Extras			
MENFSBTES-BLCK	Extra shelf - 100 x 45 H: 85 CM / 39 x 17.7 H: 33.2" and 148 x 45 H: 85 CM / 58 x 17.7 H: 33.2" - Anthracite Black	USD 257.00	-
MENFSBTES-DPRD	Extra shelf - 100 x 45 H: 85 CM / 39 x 17.7 H: 33.2" and 148 x 45 H: 85 CM / 58 x 17.7 H: 33.2" - Deep Red	USD 257.00	-
MENFSBTES-DGRN	Extra shelf - 100 x 45 H: 85 CM / 39 x 17.7 H: 33.2" and 148 x 45 H: 85 CM / 58 x 17.7 H: 33.2" - Dusty Green	USD 257.00	-

ENFOLD SIDEBOARD / 124 X 45 H: 63 CM / 49 X 17.7 H: 24.6"

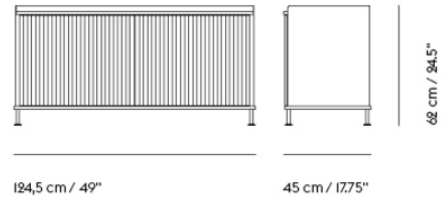

Shipper Colli	1
Gross Weight (kg)	42.54
Net Weight (kg)	38
Please note	This product includes 2 shelves. Up to 4 additional shelves can be added.
Warranty Period	10 years

Pattern No.	Color	Contract Price	Lead Time
Ready-To-Ship US Warehouse			
MENFSBL-BLCK-BLCK	Black/Anthracite Black	USD 2,676.00	-
MENFSBL-OAK-GREY	Lacquered Oak/Grey	USD 2,676.00	-
MENFSBL-OAK-DPRD	Oiled Oak/Deep Red	USD 2,676.00	-
Ready-To-Ship EU Warehouse			
MENFSBL-OAK-BLCK	Lacquered Oak/Anthracite Black	USD 2,676.00	-
Extras			
MENFSBLES-BLCK	Extra shelf - 124 x 45 H: 63 CM / 49 x 17.7 H: 24.6" and 186 x 45 H: 48 CM / 73 x 17.7 H: 18.9" - Anthracite Black	USD 257.00	-
MENFSBLES-DPRD	Extra shelf - 124 x 45 H: 63 CM / 49 x 17.7 H: 24.6" and 186 x 45 H: 48 CM / 73 x 17.7 H: 18.9" - Deep Red	USD 257.00	-
MENFSBLES-DGRN	Extra shelf - 124 x 45 H: 63 CM / 49 x 17.7 H: 24.6" and 186 x 45 H: 48 CM / 73 x 17.7 H: 18.9" - Dusty Green	USD 257.00	-
MENFSBLES-GREY	Extra shelf - 124 x 45 H: 63 CM / 49 x 17.7 H: 24.6" and 186 x 45 H: 48 CM / 73 x 17.7 H: 18.9" - Grey	USD 257.00	-

ENFOLD SIDBOARD / 148 X 45 H: 85 CM / 58 X 17.7 H: 33.2"

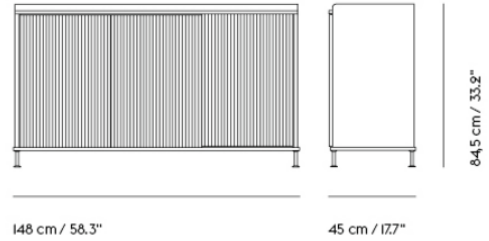

Shipper Colli	1
Gross Weight (kg)	67,55
Net Weight (kg)	52,25
Please note	This product includes 3 shelves. Up to 6 additional shelves can be added.
Warranty Period	10 years

Pattern No.	Color	Contract Price	Lead Time
Ready-To-Ship US Warehouse			
MENFSBTW-BLCK-BLCK	Black/Anthracite Black	USD 3,936.00	-
MENFSBTW-OAK-DPRD	Oiled Oak/Deep Red	USD 3,936.00	-
MENFSBTW-OAK-DGRN	Oiled Oak/Dusty Green	USD 3,936.00	-
Ready-To-Ship EU Warehouse			
MENFSBTW-OAK-BLCK	Oiled Oak/Anthracite Black	USD 3,936.00	-
MENFSBTW-OAK-GREY	Oiled Oak/Grey	USD 3,936.00	-
Extras			
MENFSBTES-BLCK	Extra shelf - 100 x 45 H: 85 CM / 39 x 17.7 H: 33.2" and 148 x 45 H: 85 CM / 58 x 17.7 H: 33.2" - Anthracite Black	USD 257.00	-
MENFSBTES-DPRD	Extra shelf - 100 x 45 H: 85 CM / 39 x 17.7 H: 33.2" and 148 x 45 H: 85 CM / 58 x 17.7 H: 33.2" - Deep Red	USD 257.00	-
MENFSBTES-DGRN	Extra shelf - 100 x 45 H: 85 CM / 39 x 17.7 H: 33.2" and 148 x 45 H: 85 CM / 58 x 17.7 H: 33.2" - Dusty Green	USD 257.00	-

ENFOLD SIDEBOARD / 186 X 45 H: 48 CM / 73 X 17.7 H: 18.9"

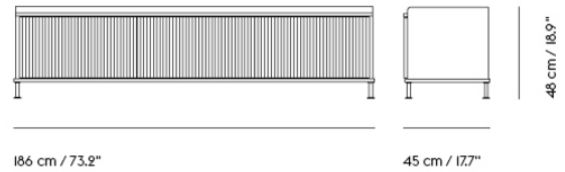
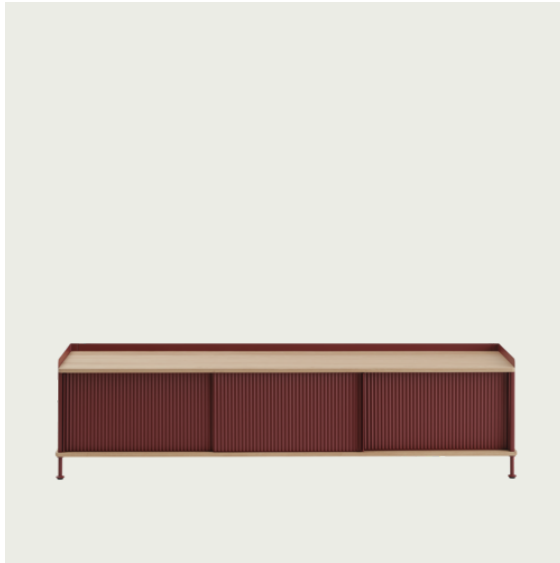

Shipper Colli	1
Gross Weight (kg)	64.74
Net Weight (kg)	48.44
Please note	This product includes 3 shelves. No additional shelves can be added.
Warranty Period	10 years

Pattern No.	Color	Contract Price	Lead Time
Ready-To-Ship US Warehouse			
MENFSBLL-BLCK-BLCK	Black/Anthracite Black	USD 3,936.00	-
MENFSBLL-OAK-DPRD	Oiled Oak/Deep Red	USD 3,936.00	-
MENFSBLL-OAK-DGRN	Oiled Oak/Dusty Green	USD 3,936.00	-
Ready-To-Ship EU Warehouse			
MENFSBLL-OAK-BLCK	Oiled Oak/Anthracite Black	USD 3,936.00	-
MENFSBLL-OAK-GREY	Oiled Oak/Grey	USD 3,936.00	-
Extras			
MENFSBLES-BLCK	Extra shelf - 124 x 45 H: 63 CM / 49 x 17.7 H: 24.6" and 186 x 45 H: 48 CM / 73 x 17.7 H: 18.9" - Anthracite Black	USD 257.00	-
MENFSBLES-DPRD	Extra shelf - 124 x 45 H: 63 CM / 49 x 17.7 H: 24.6" and 186 x 45 H: 48 CM / 73 x 17.7 H: 18.9" - Deep Red	USD 257.00	-
MENFSBLES-DGRN	Extra shelf - 124 x 45 H: 63 CM / 49 x 17.7 H: 24.6" and 186 x 45 H: 48 CM / 73 x 17.7 H: 18.9" - Dusty Green	USD 257.00	-
MENFSBLES-GREY	Extra shelf - 124 x 45 H: 63 CM / 49 x 17.7 H: 24.6" and 186 x 45 H: 48 CM / 73 x 17.7 H: 18.9" - Grey	USD 257.00	-

FIBER CHAIR SERIES

FOR MORE INFORMATION,
EXPLORE BELOW

- ↗ [Product Fact Sheet](#)
- ↗ [Images](#)
- ↗ [Architect Files](#)
- ↗ [Assembly Instructions](#)
- ↗ [Product Declaration](#)
- ↗ [Product Configurator](#)

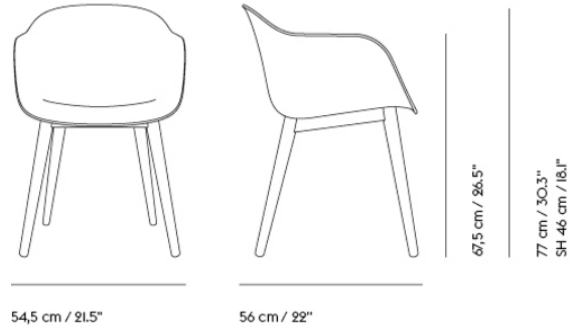

Shipper Colli	1
Gross Weight (kg)	9
Net Weight (kg)	7
Base color options	Anthracite Black, Dusty Green, Grey, Oak or Stained Dark Brown
Warranty Period	10 years

Pattern No.	Color	Contract Price	Lead Time
Ready-To-Ship US Warehouse			
MFIBAWODF-BLCK-BLCK	Black/Anthracite Black (Recycled Plastic)	USD 520.00	-
MFIBAWODF-STDB-BLCK	Black/Stained Dark Brown (Recycled Plastic) ***	USD 520.00	-
MFIBAWODF-GREY-GREY	Grey/Grey (Recycled Plastic)	USD 520.00	-
MFIBAWODF-OAK-WHIT	Natural White/Oak (Recycled Plastic)	USD 520.00	-
MFIBAWODU-GREY-M156133	Remix I33/Grey ***	USD 881.00	-
MFIBAWODU-OAK-M136COGN	Refine Leather Cognac/Oak	USD 1,465.00	-
Ready-To-Ship EU Warehouse			
MFIBAWODF-DGRN-DGRN	Dusty Green/Dusty Green (Recycled Plastic)	USD 520.00	-
MFIBAWODF-OAK-OCHR	Ochre/Oak (Recycled Plastic)	USD 520.00	-
Extras			
MGLDFWDFB4	Felt Glides for Fiber Wood Base (4 pcs per pack) - Black	USD 21.00	-
MGLDFWDFG4	Felt Glides for Fiber Wood Base (4 pcs per pack) - Grey	USD 21.00	-
MLEAKIT	Leather care set for Refine Leather	USD 27.00	-

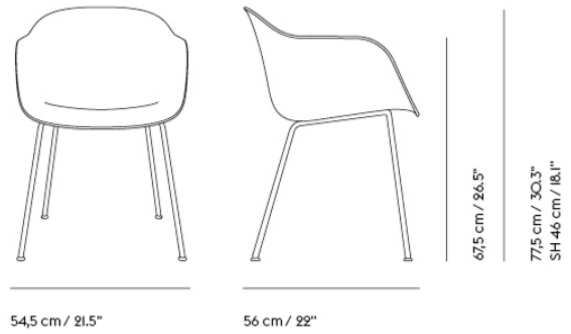

Shipper Colli	1
Gross Weight (kg)	9
Net Weight (kg)	7
Base color options	Anthracite Black, Chrome, Dusty Green, Grey or White
Warranty Period	10 years

Pattern No.	Color	Contract Price	Lead Time
Ready-To-Ship US Warehouse			
MFIBATUBF-BLCK-BLCK	Black/Anthracite Black (Recycled Plastic)	USD 415.00	-
MFIBATUBF-GREY-GREY	Grey/Grey (Recycled Plastic)	USD 415.00	-
MFIBATUBF-WHIT-WHIT	Natural White/White (Recycled Plastic)	USD 415.00	-
MFIBATUBF-BLCK-OCHR	Ochre/Anthracite Black (Recycled Plastic)	USD 415.00	-
MFIBATUBU-BLCK-M136BLCK	Refine Leather Black/Anthracite Black ***	USD 1,416.00	-
MFIBATUBU-BLCK-M136COGN	Refine Leather Cognac/Anthracite Black	USD 1,416.00	-
Ready-To-Ship EU Warehouse			
MFIBATUBF-DGRN-DGRN	Dusty Green/Dusty Green (Recycled Plastic)	USD 415.00	-
Extras			
MGLDOFVTBPB1	Plastic glides for Fiber, Oslo and Visu with Tube Base (1 pc per pack) - Black	USD 6.00	-
MGLDOFVTBFB4	Felt Glides for Fiber, Oslo and Visu with Tube Base (4 pcs per pack)	USD 21.00	-
MLEAKIT	Leather care set for Refine Leather	USD 27.00	-

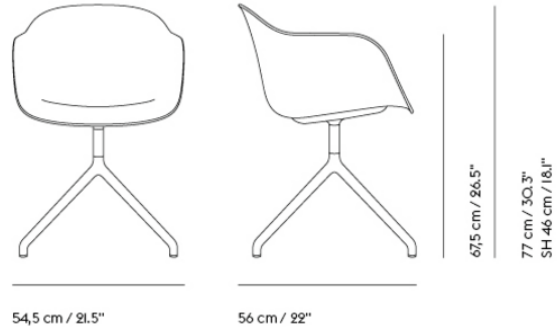

Shipper Colli	1
Gross Weight (kg)	11.9
Net Weight (kg)	7
Base color options	Anthracite Black, White, Grey, Dusty Green or Polished Aluminum.
Warranty Period	10 years

Pattern No.	Color	Contract Price	Lead Time
Ready-To-Ship US Warehouse			
MFIBASWBU-BLCK-M136BLCK	Refine Leather Black/Anthracite Black	USD 1,570.00	-
MFIBASWBU-BLCK-M136COGN	Refine Leather Cognac/Anthracite Black	USD 1,570.00	-
Extras			
MGLDFVSWFB4	Felt Glides for Fiber and Visu with Swivel Base (4 pcs per pack)	USD 21.00	-
MLEAKIT	Leather care set for Refine Leather	USD 27.00	-

FIBER ARMCHAIR / SWIVEL BASE W. CASTORS & GAS LIFT

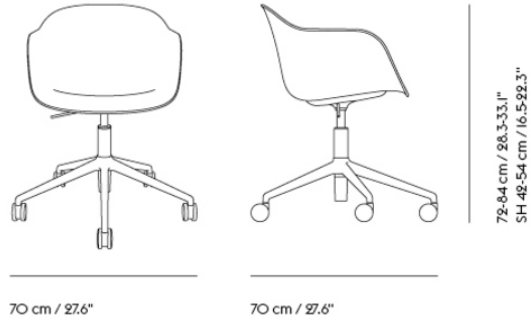

Shipper Colli	1
Gross Weight (kg)	12.6
Net Weight (kg)	7
Base color options	Anthracite Black, Grey and Polished Aluminum with Black castors. White with white castors.
Warranty Period	10 years

Pattern No.	Color	Contract Price	Lead Time
Ready-To-Ship US Warehouse			
MFIBASWGU-ALUM-M156183	Remix I83/Polished Aluminum	USD 1,101.00	-
Extras			
MLEAKIT	Leather care set for Refine Leather	USD 27.00	-

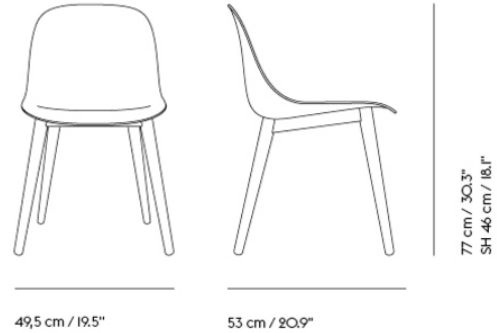

Shipper Colli	1
Gross Weight (kg)	7.4
Net Weight (kg)	5.4
Base color options	Anthracite Black, Dusty Green, Grey, Oak or Stained Dark Brown
Warranty Period	10 years

Pattern No.	Color	Contract Price	Lead Time
Ready-To-Ship US Warehouse			
MFIBSWODF-BLCK-BLCK	Black/Anthracite Black (Recycled Plastic)	USD 488.00	-
MFIBSWODF-STDB-BLCK	Black/Stained Dark Brown (Recycled Plastic) ***	USD 488.00	-
MFIBSWODF-GREY-GREY	Grey/Grey (Recycled Plastic)	USD 488.00	-
MFIBSWODF-OAK-WHIT	Natural White/Oak (Recycled Plastic)	USD 488.00	-
MFIBSWODU-OAK-M136COGN	Refine Leather Cognac/Oak	USD 1,311.00	-
Ready-To-Ship EU Warehouse			
MFIBSWODF-DGRN-DGRN	Dusty Green/Dusty Green (Recycled Plastic)	USD 488.00	-
MFIBSWODF-OAK-OCHR	Ochre/Oak (Recycled Plastic)	USD 488.00	-
Extras			
MGLDFWDFB4	Felt Glides for Fiber Wood Base (4 pcs per pack) - Black	USD 21.00	-
MGLDFWDFG4	Felt Glides for Fiber Wood Base (4 pcs per pack) - Grey	USD 21.00	-
MLEAKIT	Leather care set for Refine Leather	USD 27.00	-

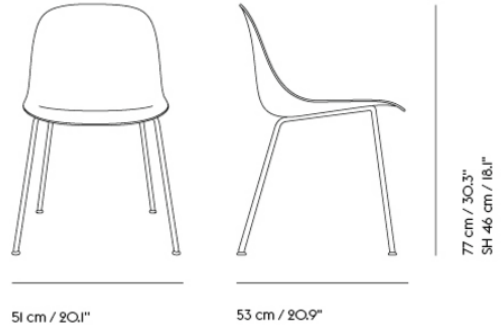

Shipper Colli	1
Gross Weight (kg)	9
Net Weight (kg)	7
Base color options	Anthracite Black, Chrome, Dusty Green, Grey or White
Warranty Period	10 Years

Pattern No.	Color	Contract Price	Lead Time
Ready-To-Ship US Warehouse			
MFIBSTUBF-BLCK-BLCK	Black/Anthracite Black (Recycled Plastic)	USD 335.00	-
MFIBSTUBF-GREY-GREY	Grey/Grey (Recycled Plastic)	USD 335.00	-
MFIBSTUBF-WHIT-WHIT	Natural White/White (Recycled Plastic)	USD 335.00	-
MFIBSTUBF-BLCK-OCHR	Ochre/Anthracite Black (Recycled Plastic)	USD 335.00	-
MFIBSTUBU-BLCK-M136COGN	Refine Leather Cognac/Anthracite Black ***	USD 1,206.00	-
Ready-To-Ship EU Warehouse			
MFIBSTUBF-DGRN-DGRN	Dusty Green/Dusty Green (Recycled Plastic)	USD 335.00	-
Extras			
MGLDOFVTBPB1	Plastic glides for Fiber, Oslo and Visu with Tube Base (1 pc per pack) - Black	USD 6.00	-
MGLDOFVTBFB4	Felt Glides for Fiber, Oslo and Visu with Tube Base (4 pcs per pack)	USD 21.00	-
MLEAKIT	Leather care set for Refine Leather	USD 27.00	-

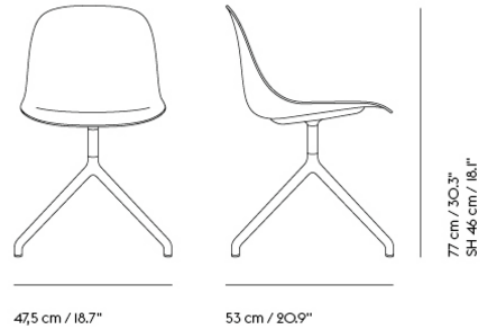

Shipper Colli	1
Gross Weight (kg)	11.9
Net Weight (kg)	7.2
Base color options	Anthracite Black, Dusty Green, Grey, Polished Aluminum or White
Warranty Period	10 years

Pattern No.	Color	Contract Price	Lead Time
Ready-To-Ship US Warehouse			
MFIBSSWBU-BLCK-M136COGN	Refine Leather Cognac/Anthracite Black	USD 1,360.00	-
Extras			
MGLDFVSWFB4	Felt Glides for Fiber and Visu with Swivel Base (4 pcs per pack)	USD 21.00	-
MLEAKIT	Leather care set for Refine Leather	USD 27.00	-

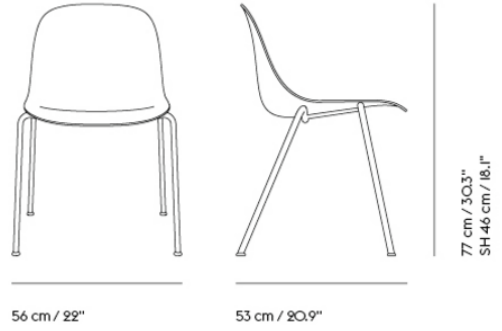

Shipper Colli	1
Gross Weight (kg)	10.3
Net Weight (kg)	7.4
Base color options	Chrome
Stacking	Up to 15 shell or 10 upholstered chairs can be stacked together
Warranty Period	10 years

Pattern No.	Color	Contract Price	Lead Time
Ready-To-Ship US Warehouse			
MFIBSAFGF-CHRO-GREY	Grey/Chrome (Recycled Plastic)	USD 440.00	-
MFIBSAFGF-CHRO-WHIT	Natural White/Chrome (Recycled Plastic)	USD 440.00	-

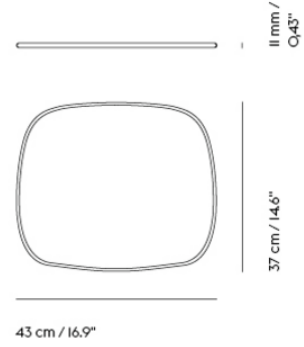

Shipper Colli 1
Gross Weight (kg) 0.35
Net Weight (kg) 0.25
Warranty Period 5 years

Pattern No.	Color	Contract Price	Lead Time
Ready-To-Ship US Warehouse			
MFIBASPAD-M156133	Remix I33	USD 93.00	-
MFIBASPAD-M141BLCK	Easy Leather Black	USD 110.00	-

FIBER ARMCHAIR WOOD, TUBE & SLED BASE

FIBER ARMCHAIR
WOOD BASE

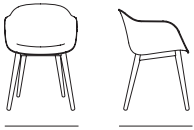

54,5 cm / 21.5"

56 cm / 22"

FIBER ARMCHAIR
TUBE BASE

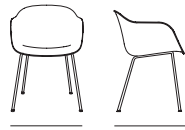

54,5 cm / 21.5"

56 cm / 22"

FIBER ARMCHAIR
SLED BASE

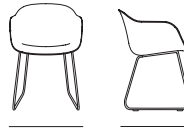

54,5 cm / 21.5"

55 cm / 21.75"

77 cm /
30.3"
SH 46 cm /
18.1"

All Variants

	Description	Pattern No.	Fiber Shell	COM					CIL					COL				
				A	B	C	E	G	H	R	T	U	V	W				
Fiber Armchair Wood Base	Fiber Shell	MFIBAWODF	520															
	Upholstered Shell	MFIBAWODU		881	1,013	1,150	1,150	1,150	1,465	1,416	1,465	1,570	1,885	2,046				
	Front Upholstery	MFIBAWODFR		866	992	1,101	1,150	1,150	1,465	1,360	1,465	1,570	1,836	1,941				
Fiber Armchair Tube Base	Fiber Shell	MFIBATUBF	415															
	Upholstered Shell	MFIBATUBU		776	902	1,013	1,024	1,101	1,416	1,255	1,416	1,465	1,731	1,885				
	Front Upholstery	MFIBATUBFR		755	881	992	1,013	1,101	1,311	1,255	1,311	1,416	1,731	1,885				
Fiber Armchair Sled Base	Fiber Shell	MFIBASLDF	415															
	Upholstered Shell	MFIBASLDU		776	902	1,013	1,024	1,045	1,416	1,255	1,416	1,465	1,731	1,885				
	Front Upholstery	MFIBASLDFR		755	881	992	1,013	1,101	1,311	1,255	1,311	1,416	1,731	1,885				

HOW TO CONFIGURE

ORDER CODE EXAMPLE: Upholstered Shell

Fiber Shell	Upholstered Shell	Front Upholstery	Fiber Armchair Wood Base Steelcut Trio 226						
Specify: Step 1) Choose variant Step 2) Choose base color Step 3) Choose Fiber Shell color	Step 1) Choose variant Step 2) Choose base color Step 3) Choose upholstery Step 4) Choose upholstery color	Step 1) Choose variant Step 2) Choose base color Step 3) Choose Fiber Shell color Step 4) Choose upholstery Step 5) Choose upholstery color	Variant	Base color	Upholstery	Upholstery color	Final Pattern No:	Fiber Armchair Wood Base - Upholstered Oak Steelcut Trio 226 MFIBAWODUOAKM139226	MFIBAWODU OAK M139 226

Base Color Options

Shell Color Options*

*When ordering Shell and Front Upholstery versions:

Tube and Sled Base:
BLCK - Black
WHIT - White
DGRN - Dusty Green
GREY - Grey
Tube base only: CHRO - Chrome

BLCK - Anthracite Black
GREY - Grey
DGRN - Dusty Green
OCHR - Ochre
WHIT - Natural White

Base and Shell can be combined as follows

Sled and Tube Base
BLCK/BLCK - Black/Black Shell
GREY/GREY - Grey/Grey Shell
WHIT/WHIT - White/Natural White Shell
DGRN/DGRN - Dusty Green/Dusty Green
BLCK/OCHR - Black/Ochre Shell
CHRO/(all colors) - Chrome/(Choose any of the shell colors)

Wood base:
OAK - Oak

STDB - Stained Dark Brown
BLCK - Black
GREY - Grey
DGRN - Dusty Green

Wood base:
BLCK/BLCK - Black/Black Shell
GREY/GREY - Grey/Grey Shell
OAK/WHIT - Oak/Natural White Shell
DGRN/DGRN - Dusty Green/Dusty Green
OAK/OCHR - Oak/Ochre Shell
STDB/(all colors) - Stained Dark Brown/(Choose any of the shell colors)

All other combinations are available as specials with a 5% upcharge via dealer portal.

Upholstery Options

A	B	C	E	G	H	R	T	U	V	W
Ocean (M161)* Remix (M156) Wooly (M159)	Cameo (K1443) Canvas (M153) Clara (M154) Fiord (M155) Grain (M12659) Knoll Hopsack (K1206) Manner (M12665) Prairie (K1925) Re-Wool (M4586) Sabi (M8404) Steelcut (M149) Steelcut Quartet (M13042) Steelcut Trio (M139) Vibe II (K2154)	Hallingdal (M146)	Acca (M12660) Aegean (K2074) Balder (M152) Beck (M6376) Divina (M150) Divina MD (M147) Divina Melange (M135) Ecriture (M10767) Hearth (M12664) Twill Weave (M142) Vidar (M158)	Modern Tweed (K2155)	Stretch Appeal (K2188)	Easy Leather (M141)	Refine Leather (M136)	Endure Leather (M137) Voio Leather (VO)	Grace Leather (M12374)	Allure Leather (M12375)

*Notes: Ocean - Color 3, 21, 32, 50, 52, 80 & 601

FIBER ARMCHAIR SWIVEL BASE W. CASTORS & CASTORS & GASLIFT

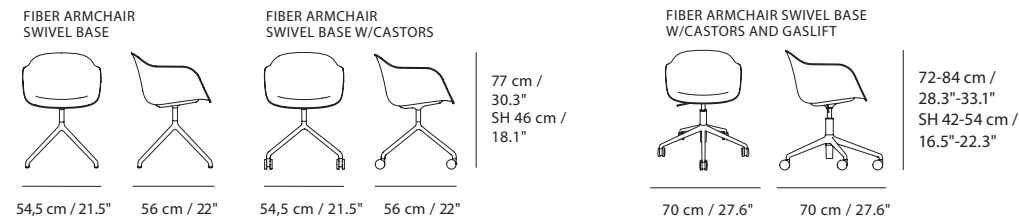

Warranty Period 10 years. 5 years for Swivel base w/return

All Variants

All Variants	Description	Pattern No.	Fiber Shell	Upholstery Grades								COL			
				A	B	C	E	G	H	R	T	U	V	W	
Fiber Armchair Swivel Base	Fiber Shell	MFIBASWBF	576												
	Upholstered Shell	MFIBASWBU		933	1,101	1,206	1,206	1,206	1,570	1,465	1,570	1,626	1,941	2,095	
	Front Upholstery	MFIBASWFR		919	1,045	1,150	1,206	1,206	1,570	1,416	1,570	1,626	1,885	2,046	
Fiber Armchair Swivel Base w. Return	Fiber Shell	MFIBASWRF	650												
	Upholstered Shell	MFIBASWRU		1,013	1,150	1,255	1,255	1,255	1,626	1,570	1,626	1,675	2,046	2,151	
	Front Upholstery	MFIBASWFR		992	1,150	1,255	1,255	1,255	1,626	1,465	1,626	1,675	2,046	2,151	
Fiber Armchair Swivel Base w. Castors	Fiber Shell	MFIBASWCF	650												
	Upholstered Shell	MFIBASWCU		1,013	1,150	1,255	1,255	1,255	1,626	1,570	1,626	1,675	2,046	2,151	
	Front Upholstery	MFIBASWCFR		992	1,150	1,255	1,255	1,255	1,626	1,465	1,626	1,675	1,941	2,151	
Fiber Armchair Swivel Base w. Castors & Gas Lift	Fiber Shell	MFIBASWGF	734												
	Upholstered Shell	MFIBASWGU		1,101	1,255	1,360	1,416	1,416	1,675	1,626	1,675	1,836	2,095	2,305	
	Front Upholstery	MFIBASWGR		1,101	1,206	1,311	1,360	1,416	1,675	1,626	1,675	1,731	2,095	2,256	

HOW TO CONFIGURE

ORDER CODE EXAMPLE: Upholstered Shell

Fiber Shell	Upholstered Shell	Front Upholstery	Fiber Armchair Swivel Base with Castors and Gas Lift Aegean in Egret/Dusty Green		
Specify: Step 1) Choose variant Step 2) Choose base color Step 3) Choose Fiber Shell color	Step 1) Choose variant Step 2) Choose base color Step 3) Choose upholstery Step 4) Choose upholstery color	Step 1) Choose variant Step 2) Choose base color Step 3) Choose Fiber Shell color Step 4) Choose upholstery Step 5) Choose upholstery color	Variant Base color Upholstery Upholstery color Final Pattern No:	Castors and gaslift - Upholstered Dusty Green Aegean Egret MFIBAWODUOAKM139226	M-FIBS-SWG-U DGRN K2074 1

Base Color Options

Shell Color Options*

*When ordering Shell and Front Upholstery versions:

Swivel Base and Swivel Base w. Return
BLCK - Anthracite Black
WHIT - White
DGRN - Dusty Green
GREY - Grey
ALUM - Polished Aluminum

BLCK - Black
GREY - Grey
DGRN - Dusty Green
OCHR - Ochre
WHIT - Natural White

Base and Shell can be combined as follows
Swivel Base, Swivel Base w. Return and Swivel Base with castors
BLCK/BLCK - Black/Black Shell
GREY/GREY - Grey/Grey Shell
WHIT/WHIT - White/Natural White Shell
DGRN/DGRN - Dusty Green/Dusty Green

Swivel base with castors and Swivel base with castors & Gaslift
BLCK - Anthracite black with black castors
GREY - Grey with black castors
ALUM - Polished Aluminum with black castors
WHIT - White with white castors

Swivel base w castors & Gaslift
BLCK/BLCK - Black/Black Shell
GREY/GREY - Grey/Grey Shell
WHIT/WHIT - White/Natural White Shell

Polished aluminum combined with any shell color and all other color combinations are available as a special via dealer portal.

Upholstery Options

A	B	C	E	G	H	R	T	U	V	W
Ocean (M161)* Remix (M156) Wooly (M159)	Beck (M6376) Cameo (K1443) Canvas (M153) Clara (M154) Fiord (M155) Grain (M12659) Knoll Hopsack (K1206) Manner (M12665) Prairie (K1925) Re-Wool (M4586) Sabi (M8404) Steelcut (M149) Steelcut Quartet (M13042) Steelcut Trio (M139) Vibe II (K2154)	Hallingdal (M146)	Acca (M12660) Aegean (K2074) Balder (M152) Divina (M150) Divina MD (M147) Divina Melange (M135) Ecriture (M10767) Hearth (M12664) Twill Weave (M142) Vidar (M158)	Modern Tweed (K2155)	Stretch Appeal (K2188)	Easy Leather (M141)	Refine Leather (M136)	Endure Leather (M137)	Grace Leather (M12374)	Allure Leather (M12375)

*Notes: Ocean - Color 3, 21, 32, 50, 52, 80 & 601

FIBER SIDE CHAIR WOOD, TUBE & SLED BASE

FIBER SIDE CHAIR
WOOD BASE



49,5 cm / 19.5" 53 cm / 21"

FIBER SIDE CHAIR
TUBE BASE



51 cm / 20" 53 cm / 21"

FIBER SIDE CHAIR
SLED BASE



47,5 cm / 18.75" 51,5 cm / 20.3"

77 cm /
30.3"
SH 46 cm /
18"

All Variants

	Description	Pattern No.	Fiber Shell	Upholstery Grades							COL			
				COM A	COM B	CIL C	E	G	H	R	T	U	V	W
Fiber Side Chair Wood Base	Fiber Shell	M-FIBS-WOD-F	488											
	Upholstered Shell	M-FIBS-WOD-U		786	919	1,045	1,045	1,101	1,311	1,206	1,311	1,416	1,675	1,836
Fiber Side Chair Tube Base	Fiber Shell	M-FIBS-TUB-F	383											
	Upholstered Shell	M-FIBS-TUB-U		681	807	919	933	954	1,206	1,101	1,206	1,255	1,570	1,675
Fiber Side Chair Sled Base	Fiber Shell	M-FIBS-SLD-F	383											
	Upholstered Shell	M-FIBS-SLD-U		681	807	919	933	954	1,206	1,101	1,206	1,255	1,570	1,675

HOW TO CONFIGURE

ORDER CODE EXAMPLE: Upholstered Shell

Fiber Shell

Upholstered Shell

Fiber Side Chair Wood Base Aegean in Egret/Dusty Green

Specify:

- Step 1) Choose variant
- Step 2) Choose base color
- Step 3) Choose Fiber Shell color

- Step 1) Choose variant
- Step 2) Choose base color
- Step 3) Choose upholstery
- Step 4) Choose upholstery color

Variant: Fiber Side Chair Wood Base - upholstered
 Base color: Oak
 Upholstery: Steelcut Trio
 Upholstery color: 226
 Final Pattern No: MFIBSWODUOAKM139226
 M-FIBS-SWG-U
 OAK
 M139
 2261

Base Color Options

Shell Color Options*

*When ordering Shell and Front Upholstery versions:

Tube and Sled Base:
 BLCK - Black
 WHIT - White
 DGRN - Dusty Green
 GREY - Grey
 Tube base only: CHRO - Chrome

BLCK - Anthracite Black
 GREY - Grey
 DGRN - Dusty Green
 OCHR - Ochre
 WHIT - Natural White

Base and Shell can be combined as follows
 Sled and Tube Base
 BLCK/BLCK - Black/Black Shell
 GREY/GREY - Grey/Grey Shell
 WHIT/WHIT - White/Natural White Shell
 DGRN/DGRN - Dusty Green/Dusty Green
 BLCK/OCHR - Black/Ochre Shell
 CHRO/(all colors) - Chrome/(Choose any of the shell colors)

Wood base:
 OAK - Oak

Wood base:
 BLCK/BLCK - Black/Black Shell
 GREY/GREY - Grey/Grey Shell
 OAK/WHIT - Oak/Natural White Shell
 DGRN/DGRN - Dusty Green/Dusty Green
 OAK/OCHR - Oak/Ochre Shell
 STDB/(all colors) - Stained Dark Brown/(Choose any of the shell colors)
 All other combinations are available as specials with a 5% upcharge via dealer portal.

STDB - Stained Dark Brown
 BLCK - Black
 GREY - Grey
 DGRN - Dusty Green

Upholstery Options

A	B	C	E	G	H	R	T	U	V	W
Ocean (M161)* Remix (M156) Wooly (M159)	Beck (M6376) Cameo (K1443) Canvas (M153) Clara (M154) Fiord (M155) Grain (M12659) Knoll Hopsack (K1206) Manner (M12665) Prairie (K1925) Re-Wool (M4586) Sabi (M8404) Steelcut (M149) Steelcut Quartet (M13042) Steelcut Trio (M139) Vibe II (K2154)	Hallingdal (M146)	Acca (M12660) Aegean (K2074) Balder (M152) Divina (M150) Divina MD (M147) Divina Melange (M135) Ecriture (M10767) Hearth (M12664) Twill Weave (M142) Vidar (M158)	Modern Tweed (K2155)	Stretch Appeal (K2188)	Easy Leather (M141)	Refine Leather (M136)	Endure Leather (M137)	Grace Leather (M12374)	Allure Leather (M12375)

*Notes:
 Ocean - Color 3, 21, 32, 50, 52, 80 & 601

FIBER SIDE CHAIR SWIVEL BASE W. CASTORS & CASTORS & GASLIFT

FIBER SIDE CHAIR SWIVEL BASE



47,5 cm / 18.75" 53 cm / 21"

FIBER SIDE CHAIR SWIVEL BASE W/CASTORS

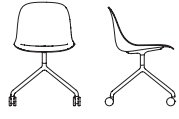

47,5 cm / 18.75" 53 cm / 21"

77 cm / 30.3"
SH 46 cm / 18.1"

FIBER SIDE CHAIR SWIVEL BASE W/CASTORS AND GASLIFT



70 cm / 27.6" 70 cm / 27.6"

72-84 cm / 28.3"-33.1"
SH 42-54 cm / 16.5"-22.3"

Warranty Period 10 years. 5 years for Swivel base w/return

All Variants

Description	Pattern No.	Fiber Shell	COM							CIL					COL				
			A	B	C	E	G	H	R	T	U	V	W						
Fiber Side Chair Swivel Base																			
Fiber Shell	M-FIBS-SWB-F	541																	
Upholstered Shell	M-FIBS-SWB-U		849	971	1,101	1,101	1,150	1,360	1,206	1,360	1,416	1,731	1,836						
Fiber Side Chair Swivel Base w. Return																			
Fiber Shell	M-FIBS-SWR-F	614																	
Upholstered Shell	M-FIBS-SWR-U		919	1,045	1,150	1,206	1,206	1,416	1,311	1,416	1,570	1,836	1,885						
Fiber Side Chair Swivel Base w. Castors																			
Fiber Shell	M-FIBS-SWC-F	614																	
Upholstered Shell	M-FIBS-SWC-U		919	1,045	1,150	1,206	1,206	1,416	1,311	1,416	1,570	1,836	1,885						
Fiber Side Chair Swivel Base w. Castors & Gas Lift																			
Fiber Shell	M-FIBS-SWG-F	702																	
Upholstered Shell	M-FIBS-SWG-U		1,013	1,150	1,255	1,255	1,311	1,570	1,416	1,570	1,626	1,885	2,046						

HOW TO CONFIGURE

ORDER CODE EXAMPLE: Upholstered Shell

Fiber Shell	Upholstered Shell	Fiber Side Chair Swivel Base with Castors and Gas Lift Aegean in Egret/Dusty Green		
Specify: Step 1) Choose variant Step 3) Choose fiber shell color	Step 1) Choose variant Step 3) Choose upholstery	Variant Base color Upholstery Upholstery color Final Pattern No:	Castors and gaslift upholstered Dusty Green Aegean Egret 1 MFIBSSWGUDGRNK20741	M-FIBS-SWG-U DGRN K2074

Base Color Options

Shell Color Options*

*When ordering Shell and Front Upholstery versions:

Swivel Base and Swivel Base w. Return
BLCK - Anthracite Black
WHIT - White
DGRN - Dusty Green
GREY - Grey
ALUM - Polished Aluminum

BLCK - Black
GREY - Grey
DGRN - Dusty Green
OCHR - Ochre
WHIT - Natural White

Base and Shell can be combined as follows

Swivel Base, Swivel Base w. Return and Swivel Base with castors
BLCK/BLCK - Black/Black Shell
GREY/GREY - Grey/Grey Shell
WHIT/WHIT - White/Natural White Shell
DGRN/DGRN - Dusty Green/Dusty Green

Swivel base with castors and Swivel base w castors & Gaslift
BLCK - Anthracite black with black castors
GREY - Grey with black castors
ALUM - Polished Aluminum with black castors
WHIT - White with white castors

Swivel base w castors & Gaslift
BLCK/BLCK - Black/Black Shell
GREY/GREY - Grey/Grey Shell
WHIT/WHIT - White/Natural White Shell

Polished aluminum combined with any shell color and all other color combinations are available as a special via dealer portal.

Upholstery Options

A	B	C	E	G	H	R	T	U	V	W
Ocean (M161)* Remix (M156) Wooly (M159)	Beck (M6376) Cameo (K1443) Canvas (M153) Clara (M154) Fiord (M155) Grain (M12659) Knoll Hopsack (K1206) Manner (M12665) Prairie (K1925) Re-Wool (M4586) Sabi (M8404) Steelcut (M149) Steelcut Quartet (M13042) Steelcut Trio (M139) Vibe II (K2154)	Hallingdal (M146)	Acca (M12660) Aegean (K2074) Balder (M152) Divina (M150) Divina MD (M147) Divina Melange (M135) Ecriture (M10767) Hearth (M12664) Twill Weave (M142) Vidar (M158)	Modern Tweed (K2155)	Stretch Appeal (K2188)	Easy Leather (M141)	Refine Leather (M136)	Endure Leather (M137)	Grace Leather (M12374)	Allure Leather (M12375)

*Notes: Ocean - Color 3, 21, 32, 50, 52, 80 & 601

FIBER SIDE CHAIR A-BASE



FIBER ARMCHAIR SLED BASE



56 cm / 22" 53 cm / 21"

FIBER SIDE CHAIR A-BASE W/LINKING DEVICE



77 cm / 30.3"
SH 46 cm / 18"

Stacking Up to 15 shell or 10 upholstered chairs can be stacked together
Warranty Period 10 years

All Variants

Description	Pattern No.	Fiber Shell	Upholstery Grades				
			A	COM B	CIL C	E	G
Fiber Side Chair A-Base w. Glides	Fiber Shell	M-FIBS-AGD-F	440				
	Upholstered Shell	M-FIBS-AGD-U		681	807	919	933
Fiber Side Chair A-Base w. Felt Glides	Fiber Shell	M-FIBS-AFG-F	440				
	Upholstered Shell	M-FIBS-AFG-U		702	828	933	954
Fiber Side Chair A-Base w. Linking Device	Fiber Shell	M-FIBS-ALD-F	440				
	Upholstered Shell	M-FIBS-ALD-U		702	828	933	954
Fiber Side Chair A-Base w. Linking Device & Felt Glides	Fiber Shell	M-FIBS-ALF-F	457				
	Upholstered Shell	M-FIBS-ALF-U		681	849	954	971

HOW TO CONFIGURE

ORDER CODE EXAMPLE: Upholstered Shell

Fiber Shell Upholstered Shell

Fiber Side Chair A-Base w/felt glides in Knoll Hopsack Olive

Specify:
Step 1) Choose variant
Step 2) Choose shell color

Step 1) Choose variant
Step 2) Choose base Color
Step 3) Choose upholstery
Step 4) Choose upholstery color

Variant M-FIBS-AFG-U-CHRO
Color K1206
Upholstery Knoll Hopsack
Upholstery color Olive
Final Pattern No: MFIBSAFGUCHROK1206

Base Color Options

Shell Finish Options

A-base:
CHRO - Chrome

BLCK - Black
GREY - Grey
DGRN - Dusty Green
OCHR - Ochre
WHIT - Natural White

Upholstery Options

A	B	C	E	G
Ocean (M161)* Remix (M156) Wooly (M159)	Beck (M6376) Cameo (K1443) Canvas (M153) Clara (M154) Fiord (M155) Grain (M12659) Knoll Hopsack (K1206) Manner (M12665) Prairie (K1925) Re-Wool (M4586) Sabi (M8404) Steelcut (M149) Steelcut Quartet (M13042) Steelcut Trio (M139) Vibe II (K2154)	Hallingdal (M146)	Acca (M12660) Aegean (K2074) Balder (M152) Divina (M150) Divina MD (M147) Divina Melange (M135) Ecriture (M10767) Hearth (M12664) Twill Weave (M142) Vidar (M158)	Modern Tweed (K2155)

*Notes:
Ocean - Color 3, 21, 32, 50, 52, 80 & 601

FIBER SOFT SERIES

**FOR MORE INFORMATION,
EXPLORE BELOW**

- ↗ [Product Fact Sheet](#)
- ↗ [Images](#)
- ↗ [Architect Files](#)
- ↗ [Assembly Instructions](#)
- ↗ [Product Declaration](#)
- ↗ [Product Configurator](#)

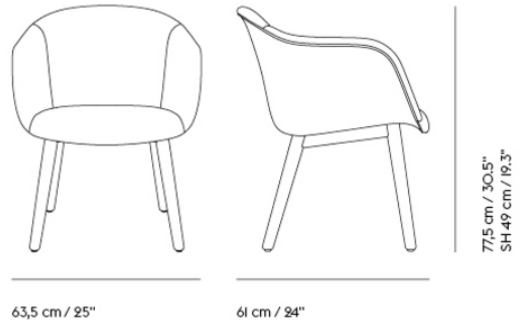

Shipper Colli	1
Gross Weight (kg)	15.632
Net Weight (kg)	12.132
Base color options	Oak, Stained Dark Brown, Anthracite Black or Grey
Warranty period	10 years

Pattern No.	Color	Contract Price	Lead Time
Ready-To-Ship EU Warehouse			
MFIBSOFAWODU-OAK-M10767240	Ecriture 240/Oak	USD 1,626.00	-
Extras			
MGLDFWDFB4	Felt Glides for Fiber Wood Base (4 pcs per pack) - Black	USD 21.00	-
MGLDFWDFG4	Felt Glides for Fiber Wood Base (4 pcs per pack) - Grey	USD 21.00	-
MLEAKIT	Leather care set for Refine Leather	USD 27.00	-

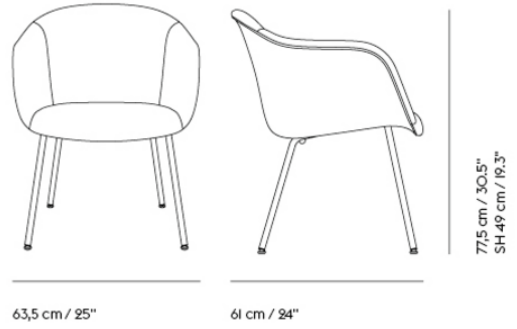

Shipper Colli	1
Gross Weight (kg)	15.117
Net Weight (kg)	19.5
Base color options	Anthracite Black or Grey
Warranty period	10 years

Pattern No.	Color	Contract Price	Lead Time
Ready-To-Ship US Warehouse			
MFIBSOFATUBU-GREY-M10767240	Ecriture 240/Grey	USD 1,465.00	-
Extras			
MGLDOFVTBPB1	Plastic glides for Fiber, Oslo and Visu with Tube Base (1 pc per pack) - Black	USD 6.00	-
MGLDOFVTBFB4	Felt Glides for Fiber, Oslo and Visu with Tube Base (4 pcs per pack)	USD 21.00	-
MLEAKIT	Leather care set for Refine Leather	USD 27.00	-



Shipper Colli	1
Gross Weight (kg)	17.305
Net Weight (kg)	13.805
Base color options	Anthracite Black or Grey
Warranty period	10 years

Pattern No.	Color	Contract Price	Lead Time
Ready-To-Ship US Warehouse			
MFIBSOFASWBU-GREY-M10767240	Ecriture 240/Grey	USD 1,626.00	-
Extras			
MGLDFVSWFB4	Felt Glides for Fiber and Visu with Swivel Base (4 pcs per pack)	USD 21.00	-
MLEAKIT	Leather care set for Refine Leather	USD 27.00	-



Swivel Base & w. Return

Shipper Colli 1 1
Gross Weight (Kg) 19.5
Warranty period 10 years

Swivel Base w. Return & Tilt

Shipper Colli 1 1
Gross Weight (Kg) 19.5
Warranty period 10 years

Swivel Base w. Castors

Shipper Colli 1 1
Gross Weight (Kg) 19.5
Warranty period 10 years

Swivel Base w. Castors & Tilt

Shipper Colli 1 1
Gross Weight (Kg) 19.5
Warranty period 10 years

Swivel Base w. Gas Lift, Castors, and Tilt

Shipper Colli 1 1
Gross Weight (Kg) 19.5
Warranty period 10 years

All Variants

FIBER SOFT - SWIVEL BASE



77.5 cm / 30.5"
SH 49cm / 19.3"

63,5 cm / 25" 60,5 cm / 23.8"

FIBER SOFT - SWIVEL BASE W. RETURN



77.5 cm / 30.5"
SH 49cm / 19.3"

63,5 cm / 25" 60,5 cm / 23.8"

FIBER SOFT - SWIVEL BASE W. RETURN & TILT



77.5 cm / 30.5"
SH 49cm / 19.3"

63,5 cm / 25" 60,5 cm / 23.8"

FIBER SOFT - SWIVEL BASE W. CASTORS



77.5 cm / 30.5"
SH 49cm / 19.3"

63,5 cm / 25" 60,5 cm / 23.8"

FIBER SOFT - SWIVEL BASE W. CASTORS AND TILT



77.5 cm / 30.5"
SH 49cm / 19.3"

63,5 cm / 25" 60,5 cm / 23.8"

FIBER SOFT - SWIVEL BASE W. CASTORS AND TILT AND GASLIFT



73.85 cm / 28.9-33.5"
SH 45-57cm / 17.6-2.22"

63,5 cm / 25" 68 cm / 26.8"

FIBER SOFT ARMCHAIR SWIVEL BASE

All Variants

All Variants	Description	Pattern No.	Upholstery Grades								
			A	B	CIL	E	R	T	COL	U	V
Fiber Soft Armchair Swivel Base	Upholstered Shell	MFIBSOFASWBU	1,311	1,465	1,626	1,626	1,941	2,046	2,095	2,410	2,571
Fiber Soft Armchair Swivel Base w. Return	Upholstered Shell	MFIBSOFASWRU	1,360	1,521	1,626	1,675	1,990	2,095	2,151	2,515	2,620
Fiber Soft Armchair Swivel Base w. Return & Tilt	Upholstered Shell	MFIBSOFASWTU	1,416	1,570	1,626	1,731	2,095	2,151	2,256	2,571	2,676
Fiber Soft Armchair Swivel Base w. Castors	Upholstered Shell	MFIBSOFASWCU	1,311	1,465	1,626	1,675	1,941	2,095	2,151	2,515	2,620
Fiber Soft Armchair Swivel Base w. Castors & Tilt	Upholstered Shell	MFIBSOFASWCTU	1,416	1,626	1,731	1,731	2,095	2,151	2,256	2,571	2,676
Fiber Soft Armchair Swivel Base w. Castors & Gas Lift, and Tilt	Upholstered Shell	MFIBSOFASWGTU	1,465	1,675	1,731	1,836	2,095	2,256	2,305	2,620	2,781

HOW TO CONFIGURE

ORDER CODE EXAMPLE: Upholstered Shell

Upholstered Shell

- Step 1) Choose variant
- Step 2) Choose base color
- Step 3) Choose upholstery
- Step 4) Choose upholstery color

Fiber Soft Armchair Swivel Base with Castors, Gas Lift, and Tilt in Twill Weave 230

Variant
Base color
Upholstery
Upholstery color
Final Pattern No:

Castors, Gaslift, & Tilt - upholstered
Anthracite Black
Twill Weave
230
MFIBSOFASWGTU^{BLCKM142230}

Base Color Options

- BLCK - Anthracite Black
- GREY - Grey

Upholstery Options

A	B	C	E	R	T	U	V	W
Ocean (M161)*	Beck (M6376)	Hallingdal (M146)	Acca (M12660)	Easy Leather (M141)	Refine Leather (M136)	Endure Leather (M137)	Grace Leather (M12374)	Allure Leather (M12375)
Remix (M156)	Cameo (K1443)		Aegean (K2074)					
Wooly (M159)	Canvas (M153)		Balder (M152)					
	Clara (M154)		Divina (M150)					
	Fiord (M155)		Divina MD (M147)					
	Grain (M12659)		Divina Melange (M135)					
	Knoll Hopsack (K1206)		Ecriture (M10767)					
	Manner (M12665)		Hearth (M12664)					
	Prairie (K1925)		Twill Weave (M142)					
	Re-Wool (M4586)		Vidar (M158)					
	Sabi (M8404)							
	Steelcut (M149)							
	Steelcut Quartet (M13042)							
	Steelcut Trio (M139)							
	Vibe II (K2154)							

*Notes:
Ocean - Color 3, 21, 32, 50, 52, 80 & 601

FIBER SOFT ARMCHAIR WOOD & TUBE BASE



FIBER SOFT -
TUBE BASE



91 cm /
35.8"
SH 44.5 cm / 17.5"

81 cm / 31.9" 91.3 cm / 35.9"

Tube Base
Shipper Colli: 1
Gross Weight (kg): 22.9
Net Weight (kg): 19.5
Warranty Period: 10 years

FIBER SOFT -
WOOD BASE

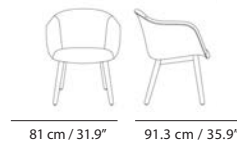

91 cm /
35.8"
SH 44.5 cm / 17.5"

81 cm / 31.9" 91.3 cm / 35.9"

Wood Base
Shipper Colli: 1
Gross Weight (kg): 22.9
Net Weight (kg): 19.5
Warranty Period: 10 years

All Variants

All Variants	Description	Pattern No.	Uphol- stery Grades		COM		CIL		COL		
			A	B	C	E	R	T	U	V	W
Fiber Soft Armchair Wood Base	Upholstered Shell	MFIBSOFAWODU	1,311	1,465	1,570	1,626	1,941	2,046	2,095	2,466	2,466
Fiber Soft Armchair Tube Base	Upholstered Shell	MFIBSOFATUBU	1,206	1,360	1,465	1,465	1,885	1,941	1,990	2,410	2,410

HOW TO CONFIGURE

ORDER CODE EXAMPLE: Upholstered Shell

Upholstered Shell

Fiber Soft Armchair Wood Base Ocean 80

- Step 1) Choose variant
- Step 2) Choose base color
- Step 3) Choose upholstery
- Step 4) Choose upholstery color

Variant: Fiber Soft Armchair Wood Base - Upholstered Oak
 Base color: Ocean OAK
 Upholstery: 80 M161
 Upholstery color: MFIBSOFAWODU-OAK-M16180
 Final Pattern No: 80

BASE COLOR OPTIONS

Tube Base:
BLCK - Black

GREY - Grey

Wood base:
OAK - Oak
STDB - Stained Dark
Brown
BLCK - Black
GREY - Grey

Upholstery Options

A	B	C	E	R	T	U	V	W
Ocean (M161)* Remix (M156) Wooly (M159)	Beck (M6376) Cameo (K1443) Canvas (M153) Clara (M154) Fiord (M155) Grain (M12659) Knoll Hopsack (K1206) Manner (M12665) Prairie (K1925) Re-Wool (M4586) Sabi (M8404) Steelcut (M149) Steelcut Quartet (M13042) Steelcut Trio (M139) Vibe II (K2154)	Hallingdal (M146)	Acca (M12660) Aegean (K2074) Balder (M152) Divina (M150) Divina MD (M147) Divina Melange (M135) Ecriture (M10767) Hearth (M12664) Twill Weave (M142) Vidar (M158)	Easy Leather (M141)	Refine Leather (M136)	Endure Leather (M137)	Grace Leather (M12374)	Allure Leather (M12375)

*Notes:
Ocean - Color 3, 21, 32, 50, 52, 80 & 601

FIBER CONFERENCE SERIES

FOR MORE INFORMATION,
EXPLORE BELOW

- ↗ Product Fact Sheet
- ↗ Images
- ↗ Architect Files
- ↗ Assembly Instructions
- ↗ Product Declaration
- ↗ Product Configurator

FIBER CONFERENCE ARMCHAIR WOOD BASE



63,5 cm / 25"



61 cm / 24"

77,5 cm / 30.5"
SH 49 cm / 19.3"

Shipper Colli	1
Gross Weight (kg)	15.63
Net Weight (kg)	12.132
Base color options	Anthracite Black, Grey, Oak and Stained Dark Brown
Warranty Period	10 years

Pattern No.	Color	Contract Price	Lead Time
Ready-To-Ship US Warehouse			
MFIBCWODU-GREY-M156133	Remix I33/Grey	USD 1,311.00	-
MFIBCWODU-OAK-M136COGN	Refine Leather Cognac/Oak	USD 2,046.00	-
Extras			
MGLDFWDFB4	Felt Glides for Fiber Wood Base (4 pcs per pack) - Black	USD 21.00	-
MGLDFWDFG4	Felt Glides for Fiber Wood Base (4 pcs per pack) - Grey	USD 21.00	-
MLEAKIT	Leather care set for Refine Leather	USD 27.00	-

FIBER CONFERENCE ARMCHAIR SWIVEL BASE



63,5 cm / 25"



60,5 cm / 23.8"

77,5 cm / 30.5"
SH 49 cm / 19.3"

Shipper Colli	1
Gross Weight (kg)	17.31
Net Weight (kg)	13.805
Base color options	Anthracite Black or Grey
Warranty period	10 years

Pattern No.	Color	Contract Price	Lead Time
Ready-To-Ship US Warehouse			
MFIBCSWBU-GREY-M156133	Remix I33/Grey	USD 1,311.00	-
MFIBCSWBU-BLCK-M136COGN	Refine Leather Cognac/Anthracite Black	USD 2,046.00	-
Extras			
MGLDFVSWFB4	Felt Glides for Fiber and Visu with Swivel Base (4 pcs per pack)	USD 21.00	-
MLEAKIT	Leather care set for Refine Leather	USD 27.00	-

FIBER CONFERENCE ARMCHAIR SWIVEL BASE W. GAS LIFT, CASTORS AND TILT

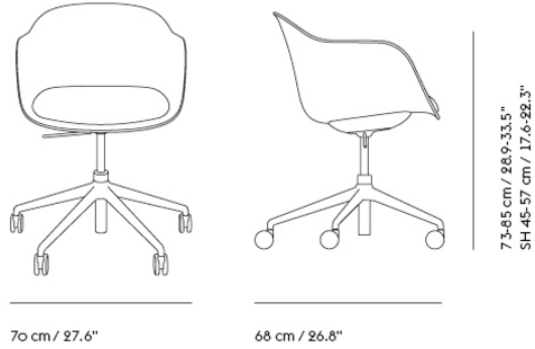

Shipper Colli	1
Gross Weight (kg)	18.78
Net Weight (kg)	15.28
Base color options	Anthracite Black or Grey
Warranty period	10 years

Pattern No.	Color	Contract Price	Lead Time
Ready-To-Ship US Warehouse			
MFIBCSWGTU-GREY-M156133	Remix I33/Grey	USD 1,521.00	-
MFIBCSWGTU-BLCK-M136COGN	Refine Leather Cognac/Anthracite Black	USD 2,256.00	-
Extras			
MLEAKIT	Leather care set for Refine Leather	USD 27.00	-



Swivel Base & w. Return

Shipper Colli 1 1
 Gross Weight (Kg) 19.5
 Warranty period 10 years

Swivel Base w. Return & Tilt

Shipper Colli 1 1
 Gross Weight (Kg) 19.5
 Warranty period 10 years

Swivel Base w. Castors

Shipper Colli 1 1
 Gross Weight (Kg) 19.5
 Warranty period 10 years

Swivel Base w. Castors & Tilt

Shipper Colli 1 1
 Gross Weight (Kg) 19.5
 Warranty period 10 years

Swivel Base w. Gas Lift, Castors, and Tilt

Shipper Colli 1 1
 Gross Weight (Kg) 19.5
 Warranty period 10 years

All Variants

FIBER CONFERENCE - SWIVEL BASE

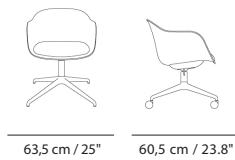

77.5 cm / 30.5"
 SH 49cm / 19.3"

FIBER CONFERENCE - SWIVEL BASE W. RETURN

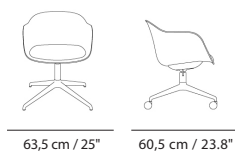

77.5 cm / 30.5"
 SH 49cm / 19.3"

FIBER CONFERENCE - SWIVEL BASE W. RETURN & TILT

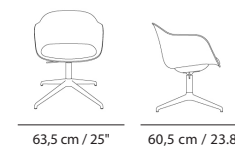

77.5 cm / 30.5"
 SH 49cm / 19.3"

FIBER CONFERENCE - SWIVEL BASE W. CASTORS

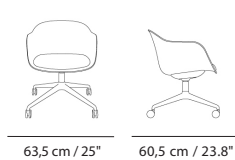

77.5 cm / 30.5"
 SH 49cm / 19.3"

FIBER CONFERENCE - SWIVEL BASE W. CASTORS AND TILT

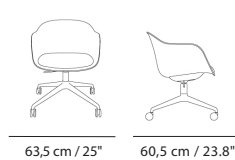

77.5 cm / 30.5"
 SH 49cm / 19.3"

FIBER CONFERENCE - SWIVEL BASE W. CASTORS AND TILT AND GASLIFT

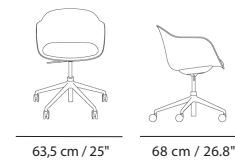

73.85 cm / 28.9-33.5"
 SH 45-57cm / 17.6-2.22"

FIBER CONFERENCE ARMCHAIR SWIVEL BASE

All Variants

All Variants	Description	Pattern No.	Upholstery Grades		COM						
			A	B	C	E	R	T	COL	U	V
Fiber Conference Armchair Swivel Base	Upholstered Shell	MFIBCSWBU	1,311	1,465	1,626	1,626	1,941	2,046	2,095	2,410	2,571
Fiber Conference Armchair Swivel Base w. Return	Upholstered Shell	MFIBCSWRU	1,360	1,521	1,626	1,675	1,990	2,095	2,151	2,515	2,620
Fiber Conference Armchair Swivel Base w. Return & Tilt	Upholstered Shell	MFIBCSWTU	1,465	1,626	1,570	1,780	2,095	2,200	2,256	2,571	2,781
Fiber Conference Armchair Swivel Base w. Castors	Upholstered Shell	MFIBCSWCU	1,360	1,521	1,626	1,675	1,990	2,095	2,151	2,515	2,620
Fiber Conference Armchair Swivel Base w. Castors & Tilt	Upholstered Shell	MFIBCSWCTU	1,465	1,626	1,731	1,780	2,095	2,200	2,256	2,571	2,781
Fiber Conference Armchair Swivel Base w. Castors & Gas Lift, and Tilt	Upholstered Shell	MFIBCSWGTU	1,521	1,675	1,731	1,836	2,151	2,256	2,305	2,620	2,781

HOW TO CONFIGURE

ORDER CODE EXAMPLE: Upholstered Shell

Upholstered Shell

- Step 1) Choose variant
- Step 2) Choose base color
- Step 3) Choose upholstery
- Step 4) Choose upholstery color

Fiber Conference Armchair Swivel Base with Castors, Gas Lift, and Tilt in Twill Weave 230

Variant
 Base color
 Upholstery
 Upholstery color
 Final Pattern No:

Castors, Gaslift, & Tilt - upholstered
 Anthracite Black
 Twill Weave
 230
 MFIBCSWGTUBLCKM142230

Base Color Options

- BLCK - Anthracite Black
- GREY - Grey

Upholstery Options

A	B	C	E	R	T	U	V	W
Ocean (M161)*	Beck (M6376)	Hallingdal (M146)	Acca (M12660)	Easy Leather (M141)	Refine Leather (M136)	Endure Leather (M137)	Grace Leather (M12374)	Allure Leather (M12375)
Remix (M156)	Cameo (K1443)		Aegean (K2074)					
Wooly (M159)	Canvas (M153)		Balder (M152)					
	Clara (M154)		Divina (M150)					
	Fiord (M155)		Divina MD (M147)					
	Grain (M12659)		Divina Melange (M135)					
	Knoll Hopsack (K1206)		Ecriture (M10767)					
	Manner (M12665)		Hearth (M12664)					
	Prairie (K1925)		Twill Weave (M142)					
	Re-Wool (M4586)		Vidar (M158)					
	Sabi (M8404)		Vidar (M158)					
	Steelcut (M149)							
	Steelcut Quartet (M13042)							
	Steelcut Trio (M139)							
	Vibe II (K2154)							

*Notes:
 Ocean - Color 3, 21, 32, 50, 52, 80 & 601

FIBER CONFERENCE ARMCHAIR WOOD & TUBE BASE



FIBER CONFERENCE -
TUBE BASE



81 cm / 31.9" 91.3 cm / 35.9"

Tube Base
Shipper Colli: 1
Gross Weight (kg): 22.9
Net Weight (kg): 19.5
Warranty Period: 10 years

FIBER CONFERENCE -
WOOD BASE



81 cm / 31.9" 91.3 cm / 35.9"

Wood Base
Shipper Colli: 1
Gross Weight (kg): 22.9
Net Weight (kg): 19.5
Warranty Period: 10 years

All Variants

All Variants	Description	Pattern No.	Uphol- stery Grades		COM C	CIL E	R	T	COL		
			A	B					U	V	W
Fiber Conference Armchair Wood Base	Upholstered Shell	MFIBCWODU	1,311	1,465	1,570	1,626	1,941	2,046	2,095	2,410	2,571
Fiber Conference Armchair Tube Base	Upholstered Shell	MFIBCTUBU	1,206	1,360	1,465	1,465	1,885	1,941	1,990	2,361	2,515

HOW TO CONFIGURE

ORDER CODE EXAMPLE: Upholstered Shell

Upholstered Shell

- Step 1) Choose variant
Step 2) Choose base color
Step 3) Choose upholstery
Step 4) Choose upholstery color

Fiber Conference Armchair Wood Base Ocean 80

Variant: Fiber Conference Armchair Wood Base - Upholstered
Base color: Oak
Upholstery: Ocean
Upholstery color: 80
Final Pattern No: MFIBCWODU-OAK-M16180

BASE COLOR OPTIONS

Tube Base:
BLCK - Black

GREY - Grey

Wood base:
OAK - Oak
STDB - Stained Dark
Brown
BLCK - Black
GREY - Grey

Upholstery Options

A	B	C	E	R	T	U	V	W
Ocean (M161)* Remix (M156) Wooly (M159)	Beck (M6376) Cameo (K1443) Canvas (M153) Clara (M154) Fiord (M155) Grain (M12659) Knoll Hopsack (K1206) Manner (M12665) Prairie (K1925) Re-Wool (M4586) Sabi (M8404) Steelcut (M149) Steelcut Quartet (M13042) Steelcut Trio (M139) Vibe II (K2154)	Hallingdal (M146)	Acca (M12660) Aegean (K2074) Balder (M152) Divina (M150) Divina MD (M147) Divina Melange (M135) Ecriture (M10767) Hearth (M12664) Twill Weave (M142) Vidar (M158) Vidar (M158)	Easy Leather (M141)	Refine Leather (M136)	Endure Leather (M137)	Grace Leather (M12374)	Allure Leather (M12375)

*Notes:
Ocean - Color 3, 21, 32, 50, 52, 80 & 601

FIBER BAR & COUNTER SERIES

FOR MORE INFORMATION,
EXPLORE BELOW

- ↗ [Product Fact Sheet](#)
- ↗ [Images](#)
- ↗ [Architect Files](#)
- ↗ [Assembly Instructions](#)
- ↗ [Product Declaration](#)
- ↗ [Product Configurator](#)

FIBER COUNTER STOOL / WOOD BASE - 65 CM / 25.6"

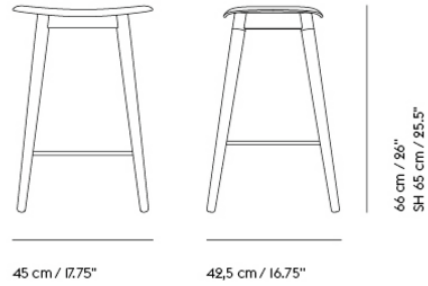

Shipper Colli	1
Gross Weight (kg)	6.1
Net Weight (kg)	4.6
Base color options	Anthracite Black, Dusty Green, Grey, Oak or Stained Dark Brown
Warranty Period	10 years

Pattern No.	Color	Contract Price	Lead Time
Ready-To-Ship US Warehouse			
MFIBSTWODCF-BLCK-BLCK	Black/Anthracite Black	USD 576.00	-
MFIBSTWODCF-GREY-GREY	Grey/Grey	USD 576.00	-
MFIBSTWODCF-OAK-WHIT	Natural White/Oak	USD 576.00	-
MFIBSTWODCU-OAK-M136COGN	Refine Leather Cognac/Oak	USD 1,013.00	-
Extras			
MGLDFWDFB4	Felt Glides for Fiber Wood Base (4 pcs per pack) - Black	USD 21.00	-
MGLDFWDFG4	Felt Glides for Fiber Wood Base (4 pcs per pack) - Grey	USD 21.00	-
MLEAKIT	Leather care set for Refine Leather	USD 27.00	-

FIBER COUNTER STOOL / WOOD BASE - WITH BACKREST - 65 CM / 25.6"



Shipper Colli	1
Gross Weight (kg)	7.2
Net Weight (kg)	5.7
Base color options	Anthracite Black, Dusty Green, Grey, Oak or Stained Dark Brown
Warranty Period	10 years

Pattern No.	Color	Contract Price	Lead Time
Ready-To-Ship US Warehouse			
MFIBSTWODCBF-OAK-WHIT	Natural White/Oak	USD 576.00	-
MFIBSTWODCBF-BLCK-BLCK	Black/Anthracite Black (Recycled Plastic)	USD 656.00	-
MFIBSTWODCBU-OAK-M136COGN	Refine Leather Cognac/Oak	USD 1,206.00	-
Ready-To-Ship EU Warehouse			
MFIBSTWODCBF-GREY-GREY	Grey/Grey (Recycled Plastic)	USD 656.00	-
Extras			
MGLDFWDFB4	Felt Glides for Fiber Wood Base (4 pcs per pack) - Black	USD 21.00	-
MGLDFWDFG4	Felt Glides for Fiber Wood Base (4 pcs per pack) - Grey	USD 21.00	-
MLEAKIT	Leather care set for Refine Leather	USD 27.00	-

FIBER BAR STOOL / WOOD BASE - 75 CM / 29.5"

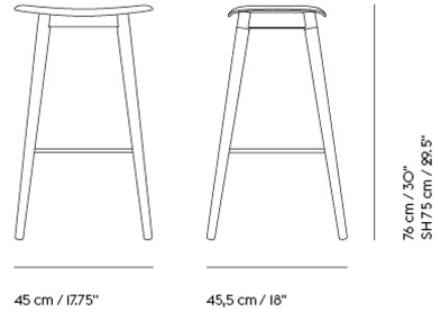

Shipper Colli	1
Gross Weight (kg)	7.1
Net Weight (kg)	5.1
Base color options	Anthracite Black, Dusty Green, Grey, Oak or Stained Dark Brown
Warranty Period	10 years

Pattern No.	Color	Contract Price	Lead Time
Ready-To-Ship US Warehouse			
MFIBSTWODBF-GREY-GREY	Grey/Grey	USD 541.00	-
MFIBSTWODBF-BLCK-BLCK	Black/Anthracite Black (Recycled Plastic)	USD 576.00	-
MFIBSTWODBF-OAK-WHIT	Natural White/Oak (Recycled Plastic)	USD 576.00	-
MFIBSTWODBU-BLCK-M136BLCK	Refine Leather Black/Anthracite Black ***	USD 1,013.00	-
MFIBSTWODBU-OAK-M136COGN	Refine Leather Cognac/Oak	USD 1,013.00	-
Extras			
MGLDFWDFB4	Felt Glides for Fiber Wood Base (4 pcs per pack) - Black	USD 21.00	-
MGLDFWDFG4	Felt Glides for Fiber Wood Base (4 pcs per pack) - Grey	USD 21.00	-
MLEAKIT	Leather care set for Refine Leather	USD 27.00	-

FIBER BAR STOOL / WOOD BASE - WITH BACKREST - 75 CM / 29.5"



Shipper Colli	1
Gross Weight (kg)	8.2
Net Weight (kg)	6.2
Base color options	Anthracite Black, Dusty Green, Grey, Oak or Stained Dark Brown
Warranty Period	10 years

Pattern No.	Color	Contract Price	Lead Time
Ready-To-Ship US Warehouse			
MFIBSTWODBBF-STDB-BLCK	Black/Stained Dark Brown ***	USD 576.00	-
MFIBSTWODBBF-BLCK-BLCK	Black/Anthracite Black (Recycled Plastic)	USD 656.00	-
MFIBSTWODBBF-OAK-WHIT	Natural White/Oak (Recycled Plastic)	USD 656.00	-
MFIBSTWODBBU-BLCK-M136BLCK	Refine Leather Black/Anthracite Black ***	USD 1,206.00	-
MFIBSTWODBBU-OAK-M136COGN	Refine Leather Cognac/Oak	USD 1,206.00	-
Extras			
MGLDFWDFB4	Felt Glides for Fiber Wood Base (4 pcs per pack) - Black	USD 21.00	-
MGLDFWDFG4	Felt Glides for Fiber Wood Base (4 pcs per pack) - Grey	USD 21.00	-
MLEAKIT	Leather care set for Refine Leather	USD 27.00	-

FIBER COUNTER STOOL / TUBE BASE - 65 CM / 25.6"

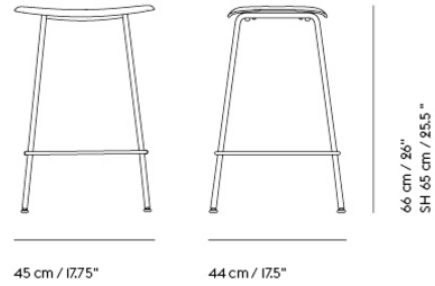

Shipper Colli	1
Gross Weight (kg)	6.1
Net Weight (kg)	4.6
Base color options	Anthracite Black, Dusty Green, Grey or White
Warranty Period	10 years

Pattern No.	Color	Contract Price	Lead Time
Ready-To-Ship US Warehouse			
MFIBSTTUBCF-BLCK-BLCK	Black/Anthracite Black (Recycled Plastic)	USD 341.00	-
MFIBSTTUBCF-GREY-GREY	Grey/Grey ***	USD 341.00	-
MFIBSTTUCU-BLCK-M136COGN	Refine Leather Cognac/Anthracite Black	USD 803.00	-
Extras			
MGLDOFVTBPB1	Plastic glides for Fiber, Oslo and Visu with Tube Base (1 pc per pack) - Black	USD 6.00	-
MGLDOFVTBFB4	Felt Glides for Fiber, Oslo and Visu with Tube Base (4 pcs per pack)	USD 21.00	-
MLEAKIT	Leather care set for Refine Leather	USD 27.00	-

FIBER COUNTER STOOL / TUBE BASE - WITH BACKREST - 65 CM / 25.6"

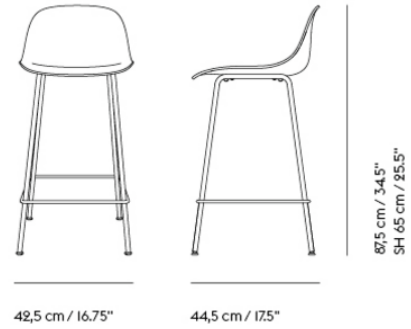

Shipper Colli	1
Gross Weight (kg)	7.2
Net Weight (kg)	5.7
Base color options	Anthracite Black, Dusty Green, Grey or White
Warranty Period	10 years

Pattern No.	Color	Contract Price	Lead Time
Ready-To-Ship US Warehouse			
MFIBSTTUBCBF-BLCK-BLCK	Black/Anthracite Black (Recycled Plastic)	USD 383.00	-
MFIBSTTUBCBF-GREY-GREY	Grey/Grey	USD 383.00	-
MFIBSTTUBCBF-WHIT-WHIT	Natural White/White (Recycled Plastic)	USD 383.00	-
MFIBSTTUBCBU-BLCK-M136COGN	Refine Leather Cognac/Anthracite Black	USD 1,013.00	-
Extras			
MGLDOFVTBPB1	Plastic glides for Fiber, Oslo and Visu with Tube Base (1 pc per pack) - Black	USD 6.00	-
MGLDOFVTBFB4	Felt Glides for Fiber, Oslo and Visu with Tube Base (4 pcs per pack)	USD 21.00	-
MLEAKIT	Leather care set for Refine Leather	USD 27.00	-

FIBER BAR STOOL / TUBE BASE - 75 CM / 29.5"

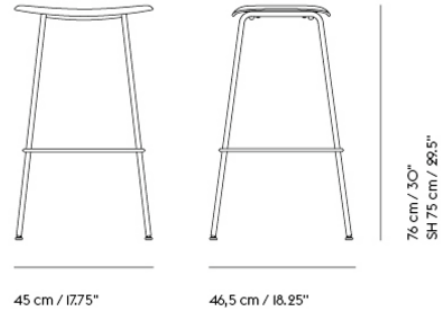

Shipper Colli	1
Gross Weight (kg)	7.1
Net Weight (kg)	5.1
Base color options	Anthracite Black, Dusty Green, Grey or White
Warranty Period	10 years

Pattern No.	Color	Contract Price	Lead Time
Ready-To-Ship US Warehouse			
MFIBSTTUBBF-BLCK-BLCK	Black/Anthracite Black	USD 341.00	-
MFIBSTTUBBF-GREY-GREY	Grey/Grey	USD 341.00	-
MFIBSTTUBBF-WHIT-WHIT	Natural White/White	USD 341.00	-
MFIBSTTUBBU-BLCK-M136BLCK	Refine Leather Black/Anthracite Black ***	USD 803.00	-
MFIBSTTUBBU-BLCK-M136COGN	Refine Leather Cognac/Anthracite Black	USD 803.00	-
Extras			
MGLDOFVTBPB1	Plastic glides for Fiber, Oslo and Visu with Tube Base (1 pc per pack) - Black	USD 6.00	-
MGLDOFVTBFB4	Felt Glides for Fiber, Oslo and Visu with Tube Base (4 pcs per pack)	USD 21.00	-
MLEAKIT	Leather care set for Refine Leather	USD 27.00	-

FIBER BAR STOOL / TUBE BASE - WITH BACKREST - 75 CM / 29.5"



Shipper Colli	1
Gross Weight (kg)	8.2
Net Weight (kg)	6.2
Base color options	Anthracite Black, Dusty Green, Grey or White
Warranty Period	10 years

Pattern No.	Color	Contract Price	Lead Time
Ready-To-Ship US Warehouse			
MFIBSTTUBBBF-BLCK-BLCK	Black/Anthracite Black (Recycled Plastic)	USD 383.00	-
MFIBSTTUBBBF-GREY-GREY	Grey/Grey (Recycled Plastic)	USD 383.00	-
MFIBSTTUBBBF-WHIT-WHIT	Natural White/White	USD 383.00	-
MFIBSTTUBBBF-BLCK-OCHR	Ochre/Black (Recycled Plastic)	USD 383.00	-
MFIBSTTUBBBU-BLCK-M136COGN	Refine Leather Cognac/Anthracite Black	USD 1,013.00	-
Extras			
MGLDOFVTBPB1	Plastic glides for Fiber, Oslo and Visu with Tube Base (1 pc per pack) - Black	USD 6.00	-
MGLDOFVTBFB4	Felt Glides for Fiber, Oslo and Visu with Tube Base (4 pcs per pack)	USD 21.00	-
MLEAKIT	Leather care set for Refine Leather	USD 27.00	-

FIBER STOOL

All Variants

	Description	Pattern No.	Fiber Shell	Upholstery Grades										
				A	B	C	E	G	H	R	T	U	V	W
Fiber Stool Tube Base	Fiber Shell	M-FIBST-TUB-S-F	289											
	Upholstered Shell	M-FIBST-TUB-S-U		488	520	562	576	597	629	614	629	719	971	971
Fiber Counter Stool Tube Base	Fiber Shell	M-FIBST-TUB-C-F	341											
	Upholstered Shell	M-FIBST-TUB-C-U		597	650	681	702	719	803	719	803	828	1,101	1,101
Fiber Bar Stool Tube Base	Fiber Shell	M-FIBST-TUB-B-F	341											
	Upholstered Shell	M-FIBST-TUB-B-U		597	650	681	702	719	803	719	803	828	1,101	1,101
Fiber Stool Wood Base	Fiber Shell	M-FIBST-WOD-S-F	436											
	Upholstered Shell	M-FIBST-WOD-S-U		719	755	807	828	866	933	919	933	971	1,255	1,255
Fiber Counter Stool Wood Base	Fiber Shell	M-FIBST-WOD-C-F	576											
	Upholstered Shell	M-FIBST-WOD-C-U		881	933	971	992	1,013	1,013	996	1,013	1,024	1,311	1,311
Fiber Bar Stool Wood Base	Fiber Shell	M-FIBST-WOD-B-F	576											
	Upholstered Shell	M-FIBST-WOD-B-U		881	933	971	992	1,013	1,013	996	1,013	1,024	1,311	1,311

HOW TO CONFIGURE

ORDER CODE EXAMPLE: Upholstered Shell

Fiber Shell	Upholstered Shell	Fiber Bar Stool with Tube Base with Castors and Gas Lift Aegean in Egret/Dusty Green
Specify: Step 1) Choose variant Step 2) Choose base color Step 3) Choose Fiber Shell color	Step 1) Choose variant Step 2) Choose base color Step 3) Choose upholstery Step 4) Choose upholstery color	Variant: Fiber Bar Stool, Wood Base Base color: Stained Dark Brown Upholstery: Hero Upholstery color: 751 Final Pattern No: MFIBSTWODBUSTDBM164751

Base Color Options

Shell Color Options*

*When ordering Shell and Front Upholstery versions:

<p>Tube Base</p> <p>BLCK - Black WHIT - White DGRN - Dusty Green GREY - Grey</p> <p>Wood base</p> <p>OAK - Oak STDB - Stained Dark Brown BLCK - Black GREY - Grey DGRN - Dusty Green</p>	<p>BLCK - Anthracite Black GREY - Grey DGRN - Dusty Green OCHR - Ochre WHIT - Natural White</p>	<p>Base and Shell can be combined as follows</p> <p>Tube Base</p> <p>BLCK/BLCK - Black/Black Shell GREY/GREY - Grey/Grey Shell WHIT/WHIT - White/Natural White Shell DGRN/DGRN - Dusty Green/Dusty Green BLCK/OCHR - Black/Ochre Shell</p> <p>Wood base</p> <p>BLCK/BLCK - Black/Black Shell GREY/GREY - Grey/Grey Shell OAK/WHIT - Oak/Natural White Shell DGRN/DGRN - Dusty Green/Dusty Green OAK/OCHR - Oak/Ochre Shell STDB/(all colors) - Stained Dark Brown/(Choose any of the shell colors)</p> <p>All other combinations are available as specials with a 5% upcharge via dealer portal.</p>
--	---	--

Upholstery Options

A	B	C	E	G	H	R	T	U	V	W
Ocean (M161)* Remix (M156) Wooly (M159)	Beck (M6376) Cameo (K1443) Canvas (M153) Clara (M154) Fiord (M155) Grain (M12659) Knoll Hopsack (K1206) Manner (M12665) Prairie (K1925) Re-Wool (M4586) Sabi (M8404) Steelcut (M149) Steelcut Quartet (M13042) Steelcut Trio (M139) Vibe II (K2154)	Hallingdal (M146)	Acca (M12660) Aegean (K2074) Balder (M152) Divina (M150) Divina MD (M147) Divina Melange (M135) Ecriture (M10767) Hearth (M12664) Twill Weave (M142) Vidar (M158)	Modern Tweed (K2155)	Stretch Appeal (K2188)	Easy Leather (M141)	Refine Leather (M136)	Endure Leather (M137)	Grace Leather (M12374)	Allure Leather (M12375)

*Notes:
Ocean - Color 3, 21, 32, 50, 52, 80 & 601

FIBER STOOL W. BACKREST

All Variants

			Upholstery Grades										
			COM			CIL			COL				
Description	Pattern No.	Fiber Shell	A	B	C	E	G	H	R	T	U	V	W
Fiber Counter Stool Tube Base w. Backrest													
Fiber Shell	M-FIBST-TUB-CB-F	383											
Upholstered Shell	M-FIBST-TUB-CB-U		681	755	807	828	866	1,013	933	1,013	1,024	1,311	1,311
Fiber Bar Stool Tube Base w. Backrest													
Fiber Shell	M-FIBST-TUB-BB-F	383											
Upholstered Shell	M-FIBST-TUB-BB-U		681	755	807	828	866	1,013	933	1,013	1,024	1,311	1,311
Fiber Counter Stool Wood Base w. Backrest													
Fiber Shell	M-FIBST-WOD-CB-F	576											
Upholstered Shell	M-FIBST-WOD-CB-U		971	1,045	1,101	1,150	1,150	1,206	1,150	1,206	1,255	1,570	1,570
Fiber Bar Stool Wood Base w. Backrest													
Fiber Shell	M-FIBST-WOD-BB-F	576											
Upholstered Shell	M-FIBST-WOD-BB-U		971	1,045	1,101	1,150	1,150	1,206	1,150	1,206	1,255	1,570	1,570

HOW TO CONFIGURE

ORDER CODE EXAMPLE: Upholstered Shell

Fiber Shell	Upholstered Shell	Fiber Bar Stool wood base w/backrest Hero 751		
Specify: Step 1) Choose variant Step 2) Choose base color Step 3) Choose Fiber Shell color	Step 1) Choose variant Step 2) Choose base color Step 3) Choose upholstery Step 4) Choose upholstery color	Variant Base color Upholstery Upholstery color Final Pattern No:	Fiber Bar Stool wood base w/backrest Stained Dark Brown Hero 751 MFIBSTWODBUSTDBM164751	MFIBSTWODBBU STDB M164 751

Base Color Options

Tube Base
BLCK - Black
WHIT - White
DGRN - Dusty Green
GREY - Grey

Wood base
OAK - Oak
STDB - Stained Dark Brown
BLCK - Black
GREY - Grey
DGRN - Dusty Green

Shell Color Options*

BLCK - Anthracite Black
GREY - Grey
DGRN - Dusty Green
OCHR - Ochre
WHIT - Natural White

*When ordering Shell and Front Upholstery versions:

Base and Shell can be combined as follows
Tube Base
BLCK/BLCK - Black/Black Shell
GREY/GREY - Grey/Grey Shell
WHIT/WHIT - White/Natural White Shell
DGRN/DGRN - Dusty Green/Dusty Green
BLCK/OCHR - Black/Ochre Shell

Wood base
BLCK/BLCK - Black/Black Shell
GREY/GREY - Grey/Grey Shell
OAK/WHIT - Oak/Natural White Shell
DGRN/DGRN - Dusty Green/Dusty Green
OAK/OCHR - Oak/Ochre Shell
STDB/(all colors) - Stained Dark Brown/(Choose any of the shell colors)

All other combinations are available as specials with a 5% upcharge via dealer portal.

Upholstery Options

A	B	C	E	G	H	R	T	U	V	W
Ocean (M161)* Remix (M156) Wooly (M159)	Beck (M6376) Cameo (K1443) Canvas (M153) Clara (M154) Fiord (M155) Grain (M12659) Knoll Hopsack (K1206) Manner (M12665) Prairie (K1925) Re-Wool (M4586) Sabi (M8404) Steelcut (M149) Steelcut Quartet (M13042) Steelcut Trio (M139) Vibe II (K2154)	Hallingdal (M146)	Acca (M12660) Aegean (K2074) Balder (M152) Divina (M150) Divina MD (M147) Divina Melange (M135) Ecriture (M10767) Hearth (M12664) Twill Weave (M142) Vidar (M158)	Modern Tweed (K2155)	Stretch Appeal (K2188)	Easy Leather (M141)	Refine Leather (M136)	Endure Leather (M137)	Grace Leather (M12374)	Allure Leather (M12375)

*Notes:
Ocean - Color 3, 21, 32, 50, 52, 80 & 601

FIBER LOUNGE SERIES

**FOR MORE INFORMATION,
EXPLORE BELOW**

- ↗ [Product Fact Sheet](#)
- ↗ [Images](#)
- ↗ [Architect Files](#)
- ↗ [Assembly Instructions](#)
- ↗ [Product Declaration](#)
- ↗ [Product Configurator](#)

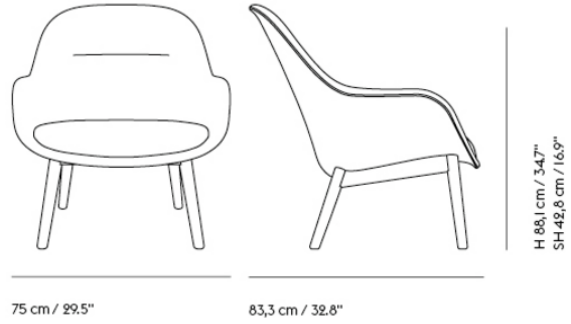

Shipper Colli	1
Gross Weight (kg)	22
Net Weight (kg)	17
Base color options	Anthracite Black, Dusty Green, Oak, Grey, Stained Dark Brown
Warranty Period	10 years

Pattern No.	Color	Contract Price	Lead Time
Ready-To-Ship US Warehouse			
MFIBLACWODU-OAK-M10767240	Ecriture 240/Oak	USD 2,830.00	-
MFIBLACWODU-BLCK-M136COGN	Refine Leather Cognac/Anthracite Black	USD 3,355.00	-
Extras			
MGLDFWDFB4	Felt Glides for Fiber Wood Base (4 pcs per pack) - Black	USD 21.00	-
MGLDFWDFG4	Felt Glides for Fiber Wood Base (4 pcs per pack) - Grey	USD 21.00	-
MLEAKIT	Leather care set for Refine Leather	USD 27.00	-

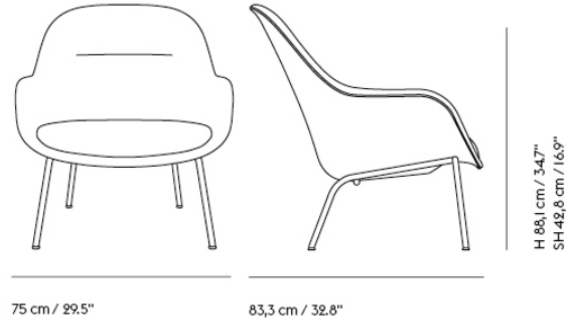

Shipper Colli	1
Gross Weight (kg)	22
Net Weight (kg)	17
Base color options	Anthracite Black, Dusty Green, Grey
Warranty Period	10 years

Pattern No.	Color	Contract Price	Lead Time
Ready-To-Ship US Warehouse			
MFIBLACTUBU-GREY-M10767240	Ecriture 240/Grey	USD 2,571.00	-
MFIBLACTUBU-BLCK-M136COGN	Refine Leather Cognac/Anthracite Black	USD 3,096.00	-
Extras			
MGLDOFVTBFB4	Felt Glides for Fiber, Oslo and Visu with Tube Base (4 pcs per pack)	USD 21.00	-
MLEAKIT	Leather care set for Refine Leather	USD 27.00	-



Shipper Colli	1
Gross Weight (kg)	11.5
Net Weight (kg)	8
Base color options	Anthracite Black, Dusty Green, Grey, Oak or Stained Dark Brown
Warranty Period	10 years

Pattern No.	Color	Contract Price	Lead Time
Ready-To-Ship US Warehouse			
MFIBLWODU-OAK-M139236	Steelcut Trio 236/Oak	USD 1,465.00	-
Ready-To-Ship EU Warehouse			
MFIBLWODU-GREY-M156133	Remix 133/Grey	USD 1,360.00	-
Extras			
MGLDFWDFB4	Felt Glides for Fiber Wood Base (4 pcs per pack) - Black	USD 21.00	-
MGLDFWDFG4	Felt Glides for Fiber Wood Base (4 pcs per pack) - Grey	USD 21.00	-
MLEAKIT	Leather care set for Refine Leather	USD 27.00	-

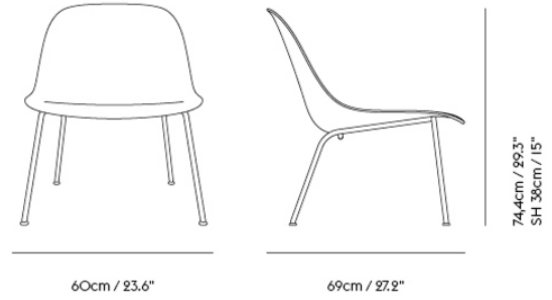

Shipper Colli	1
Gross Weight (kg)	11.5
Net Weight (kg)	8
Base color options	Anthracite Black, Dusty Green, Grey or White
Warranty Period	10 years

Pattern No.	Color	Contract Price	Lead Time
Ready-To-Ship US Warehouse			
MFIBLTUBF-WHIT-WHIT	Natural White/White	USD 597.00	-
MFIBLTUBU-BLCK-M139236	Steelcut Trio 236/Anthracite Black	USD 1,311.00	-
Ready-To-Ship EU Warehouse			
MFIBLTUBU-GREY-M156133	Remix I33/Grey	USD 1,150.00	-
MFIBLTUBU-BLCK-M150154	Divina I54/Anthracite Black ***	USD 1,416.00	-
Extras			
MGLDOFVTBPB1	Plastic glides for Fiber, Oslo and Visu with Tube Base (1 pc per pack) - Black	USD 6.00	-
MGLDOFVTBFB4	Felt Glides for Fiber, Oslo and Visu with Tube Base (4 pcs per pack)	USD 21.00	-
MLEAKIT	Leather care set for Refine Leather	USD 27.00	-

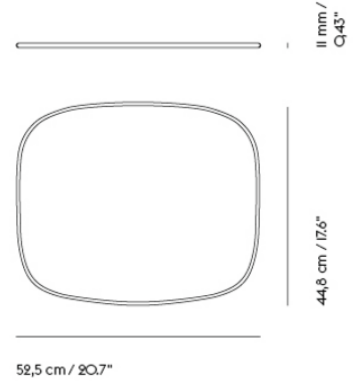

Shipper Colli 1
 Gross Weight (kg) 0.45
 Net Weight (kg) 0.35
 Warranty Period 5 years

Pattern No.	Color	Contract Price	Lead Time
Ready-To-Ship EU Warehouse			
MFIBLGPAD-M156133	Remix I33	USD 100.00	-
MFIBLGPAD-M141BLCK	Easy Leather Black	USD 121.00	-

FIBER LOUNGE ARMCHAIR



FIBER LOUNGE ARMCHAIR - TUBE BASE

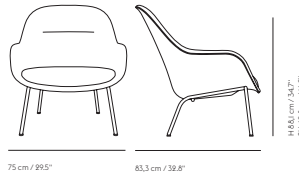

Tube Base
 Shipper Colli: 1
 Gross Weight (kg): 22
 Net Weight (kg): 17
 Warranty Period: 10 years

FIBER LOUNGE ARMCHAIR - WOOD BASE

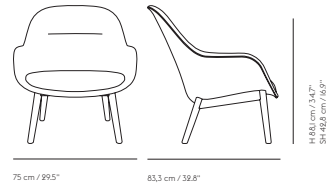

Wood Base
 Shipper Colli: 1
 Gross Weight (kg): 22
 Net Weight (kg): 17
 Warranty Period: 10 years

All Variants

All Variants	Description	Pattern No.	Upholstery Grades		COM	CIL	R	T	COL		
			A	B					U	V	W
Fiber Lounge Armchair Wood Base	Upholstered Shell	MFIBLACWODU	2,046	2,305	2,410	2,571	2,935	3,096	3,201	3,355	3,516
Fiber Lounge Armchair Tube	Upholstered Shell	MFIBLACTUBU	2,305	2,571	2,676	2,830	3,201	3,355	3,516	3,621	3,775

HOW TO CONFIGURE

ORDER CODE EXAMPLE: Upholstered Shell

Upholstered Shell

- Step 1) Choose variant
- Step 2) Choose base color
- Step 3) Choose upholstery
- Step 4) Choose upholstery color

Fiber Lounge Armchair Wood Base Ocean 80

Variant: Fiber Lounge Armchair Wood Base - Upholstered
 Base color: Oak
 Upholstery: Ocean
 Upholstery color: 80
 Final Pattern No: MFIBLACWODU-OAK-M16180

OAK
 M161
 80

BASE COLOR OPTIONS

Tube Base:
 BLCK - Black
 GREY - Grey

DGRN - Dusty Green

Wood base:
 OAK - Oak
 STDB - Stained Dark Brown
 BLCK - Black
 GREY - Grey

Upholstery Options

A	B	C	E	R	T	U	V	W
Ocean (M161)* Remix (M156) Wooly (M159)	Beck (M6376) Canvas (M153) Clara (M154) Grain (M12659) Manner (M12665) Re-Wool (M4586) Sabi (M8404) Steelcut (M149) Steelcut Quartet (M13042) Steelcut Trio (M139)	Hallingdal (M146)	Acca (M12660) Balder (M152) Divina (M150) Divina MD (M147) Divina Melange (M135) Ecriture (M10767) Hearth (M12664) Twill Weave (M142) Vidar (M158)	Easy Leather (M141)	Refine Leather (M136)	Endure Leather (M137)	Grace Leather (M12374)	Allure Leather (M12375)

*Notes:
 Ocean - Color 3, 21, 32, 50, 52, 80 & 601

FIBER LOUNGE CHAIR



All Variants

Contract Price

Description	Pattern No.	Fiber Shell	Upholstery Grades												
			COM			CIL			COL						
			A	B	C	E	G	H	R	T	U	V	W		
Fiber Lounge Tube Base	Fiber Shell	M-FIBL-TUB-F	597												
	Upholstered Shell	M-FIBL-TUB-U		1,150	1,311	1,416	1,416	1,416	1,836	1,731	1,836	1,941	2,410	2,620	
Fiber Lounge Wood Base	Fiber Shell	M-FIBL-WOD-F	803												
	Upholstered Shell	M-FIBL-WOD-U		1,360	1,465	1,570	1,626	1,626	2,095	1,941	2,095	2,305	2,830	2,935	

HOW TO CONFIGURE

ORDER CODE EXAMPLE: Upholstered Shell

Fiber Shell	Upholstered Shell	Fiber Lounge Chair Wood Base Endure Olive / Black base
Specify: Step 1) Choose variant Step 2) Choose base color Step 3) Choose Fiber Shell color	Step 1) Choose variant Step 2) Choose base color Step 3) Choose upholstery Step 4) Choose upholstery color	Variant: Fiber Lounge Chair Wood Base - Upholstered Base color: Black Upholstery: Endure Upholstery color: Olive Final Pattern No: MFIBLWODUBLCKM137OLVE

Base Color Options

Shell Color Options*

*When ordering Shell and Front Upholstery versions:

Tube Base:
BLCK - Black
WHIT - White
DGRN - Dusty Green
GREY - Grey

BLCK - Black
GREY - Grey
DGRN - Dusty Green
OCHR - Ochre
WHIT - Natural White

Base and Shell can be combined as follows
Tube Base:
BLCK/BLCK - Black/Black Shell
GREY/GREY - Grey/Grey Shell
WHIT/WHIT - White/Natural White Shell
BLCK/OCHR - Black/Ochre Shell

Wood base:
OAK - Oak
STDB - Stained Dark Brown
BLCK - Black
GREY - Grey
DGRN - Dusty Green

Wood base:
BLCK/BLCK - Black/Black Shell
GREY/GREY - Grey/Grey Shell
OAK/WHIT - Oak/Natural White Shell
OAK/OCHR - Oak/Ochre Shell
STDB/(all colors) - Stained Dark Brown/(Choose any of the shell colors)

All other combinations are available as specials with a 5% upcharge via dealer portal.

Upholstery Options

A	B	C	E	G	H	R	T	U	V	W
Ocean (M161)* Remix (M156) Wooly (M159)	Beck (M6376) Cameo (K1443) Canvas (M153) Clara (M154) Fiord (M155) Grain (M12659) Knoll Hopsack (K1206) Manner (M12665) Prairie (K1925) Re-Wool (M4586) Sabi (M8404) Steelcut (M149) Steelcut Quartet (M13042) Steelcut Trio (M139) Vibe II (K2154)	Hallingdal (M146)	Acca (M12660) Aegean (K2074) Balder (M152) Divina (M150) Divina MD (M147) Divina Melange (M135) Ecriture (M10767) Hearth (M12664) Twill Weave (M142) Vidar (M158)	Modern Tweed (K2155)	Stretch Appeal (K2188)	Easy Leather (M141)	Refine Leather (M136)	Endure Leather (M137)	Grace Leather (M12374)	Allure Leather (M12375)

*Notes:
Ocean - Color 3, 21, 32, 50, 52, 80 & 601

FIBER OUTDOOR SERIES

FOR MORE INFORMATION,
EXPLORE BELOW

- ↗ [Product Fact Sheet](#)
- ↗ [Images](#)
- ↗ [Architect Files](#)
- ↗ [Product Declaration](#)

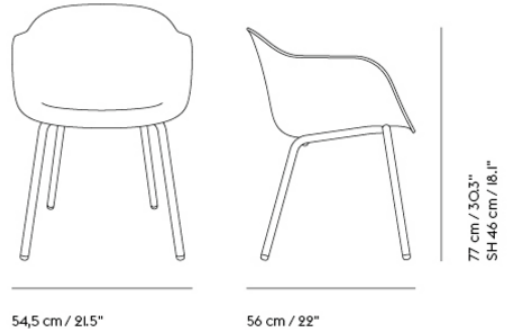

Shipper Colli 1
 Gross Weight (kg) 5.5
 Net Weight (kg) 6.5
 Warranty Period 10 years

Pattern No.	Color	Contract Price	Lead Time
Ready-To-Ship US Warehouse			
MFIBOAWDHTUB-BLCK	Anthracite Black	USD 415.00	-
MFIBOATUB-BLCK	Anthracite Black - without drain holes	USD 415.00	-
MFIBOAWDHTUB-BRRD	Brown Red	USD 415.00	-
MFIBOATUB-BRRD	Brown Red - without drain holes	USD 415.00	-
MFIBOAWDHTUB-DGRN	Dusty Green	USD 415.00	-
MFIBOATUB-DGRN	Dusty Green - without drain holes	USD 415.00	-
MFIBOSWDHTUB-GREY	Grey	USD 415.00	-
MFIBOSTUB-GREY	Grey - without drain holes	USD 415.00	-

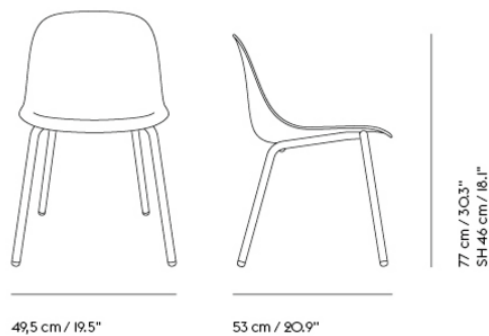
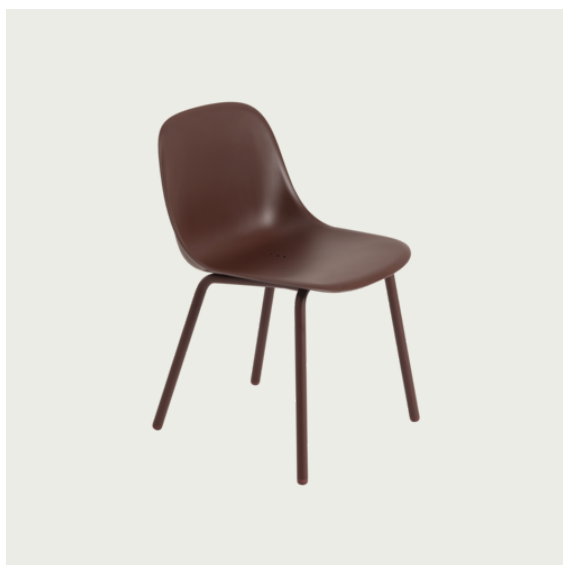

Shipper Colli |
 Gross Weight (kg) 4.5
 Net Weight (kg) 4.9
 Warranty Period 10 years

Pattern No.	Color	Contract Price	Lead Time
Ready-To-Ship US Warehouse			
MFIBOSWDHTUB-BLCK	Anthracite Black	USD 383.00	-
MFIBOSTUB-BLCK	Anthracite Black - without drain holes	USD 383.00	-
MFIBOSTUB-BRRD	Brown Red - without drain holes	USD 383.00	-
MFIBOSWDHTUB-DGRN	Dusty Green	USD 383.00	-
MFIBOSTUB-DGRN	Dusty Green - without drain holes	USD 383.00	-
MFIBOSWDHTUB-GREY	Grey	USD 383.00	-
MFIBOSTUB-GREY	Grey - without drain holes	USD 383.00	-
MFIBOSWDHTUB-BRRD	Brown Red	USD 383.00	-

FIVE POUF

**FOR MORE INFORMATION,
EXPLORE BELOW**

- [↗ Product Fact Sheet](#)
- [↗ Images](#)
- [↗ Architect Files](#)
- [↗ Product Declaration](#)
- [↗ Product Configurator](#)



All Variants

		Upholstery Grades			
		COM		CIL	
	Pattern No.	A	B	C	E
Large	M-FIVEP-LG	1,570	1,836	2,095	2,151
Extra Large	M-FIVEP-XL	3,306	3,516	3,831	4,146

HOWTO CONFIGURE

Five Pouf
Specify:
Step 1) Choose Size
Step 2) Choose textile
Step 3) Choose textile color

ORDER CODE EXAMPLE:
Upholstered Shell

Five Pouf XL in Remix 133

Size	Five Pouf Extra Large	MFIVEPXL
Textile	Remix	M156
Textile Color	133	133
Final Pattern No:	MFIVEPXL156133	

Upholstery Options

A	B	E
Remix (M156)	Beck (M6376) Canvas (M153) Fiord (M155) Grain (M12659) Manner (M12665) Re-Wool (M4586) Sabi (M8404) Steelcut (M149) Steelcut Trio (M139)	Acca (M12660) Divina (M150) Divina MD (M147) Divina Melange (M135) Ecriture (M10767) Hearth (M12664) Twill Weave (M142)

FLOW SERIES

**FOR MORE INFORMATION,
EXPLORE BELOW**

- ↗ [Product Fact Sheet](#)
- ↗ [Images](#)
- ↗ [Architect Files](#)
- ↗ [Assembly Instructions](#)
- ↗ [Product Declaration](#)

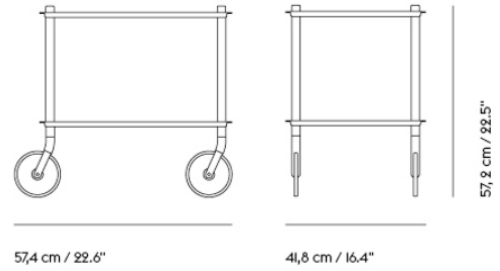

Shipper Colli 1
Gross Weight (kg) 15.2
Net Weight (kg) 12.7
Warranty Period 5 years

Pattern No.	Color	Contract Price	Lead Time
Ready-To-Ship US Warehouse			
MFT2L-BUGY	Blue-Grey	USD 671.00	-
MFT2L-GREY	Grey	USD 671.00	-
MFT2L-TAUP	Taupe	USD 782.00	-

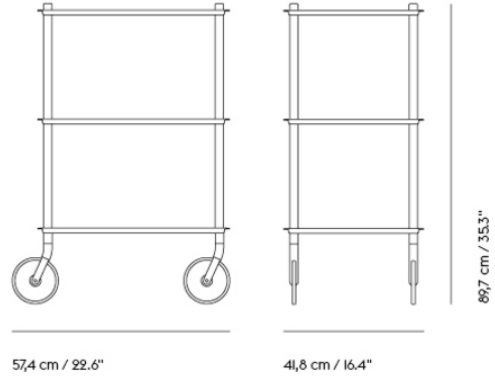

Shipper Colli 2
Gross Weight (kg) 22.4
Net Weight (kg) 18.5
Warranty Period 5 years

Pattern No.	Color	Contract Price	Lead Time
Ready-To-Ship US Warehouse			
MFT3L-BUGY	Blue-Grey	USD 902.00	-
MFT3L-GREY	Grey	USD 902.00	-
MFT3L-TAUP	Taupe	USD 1,101.00	-



95 cm / 37.4"



40,06 cm / 15.8"

95,5 cm / 37.6"

Shipper Colli	1
Gross Weight (kg)	39,5
Net Weight (kg)	33,3
Warranty Period	10 years

Pattern No.	Color	Contract Price	Lead Time
Ready-To-Ship US Warehouse			
MFCTBL-GREY	Grey	USD 1,521.00	-
MFCTBL-TAUP	Taupe	USD 1,521.00	-

IN SITU MODULAR SOFA SERIES

FOR MORE INFORMATION,
EXPLORE BELOW

- ↗ [Product Fact Sheet](#)
- ↗ [Images](#)
- ↗ [Architect Files](#)
- ↗ [Assembly Instructions](#)
- ↗ [Product Declaration](#)
- ↗ [Product Planner](#)

A grand modular sofa that can be tailored to your exact needs with its modular elements hidden through the subtle detailing of the frame's front profile, paired with deep comfort and a soft seat.

With the In Situ Modular Sofa, you can choose between any of the 30 predesigned configurations on the following pages or create your own configuration, following the guidelines below.

Visit planner.muuto.com to create your own configuration online.

Create your own In Situ Configuration

1. SEATING MODULES

Find the seating modules of your desired configuration and add the item numbers of the desired textile or leather upholstery separately to your order.

You can only connect modules to the open sides and end of the modules, illustrated here with dotted lines.

An In Situ configuration must always have one of the following seating modules at each end: Armrest Module (A80, B80, H98 or I98), Ottoman Module (D80) or Open-Ended Module (F98 or G98).

The Ottoman Module (D80) can only be used in extension of Open-Ended Modules (F98 or G98) or as the only free-standing I-Seater configuration possible to build.

SEATING MODULES

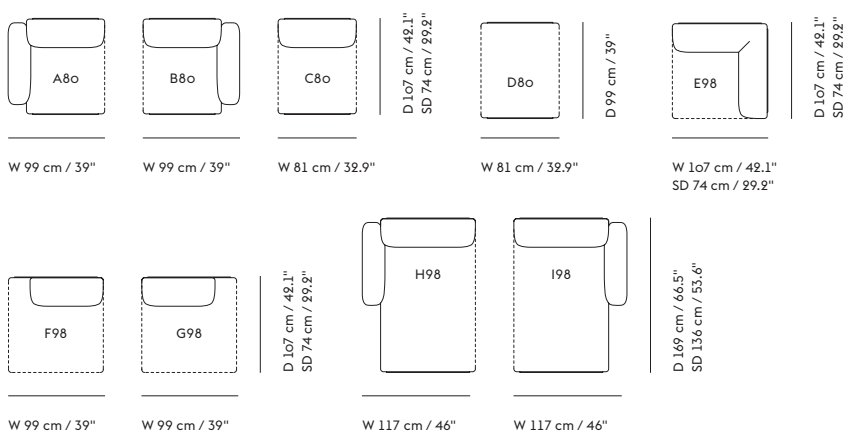

2. FRAME SECTIONS

Choose the frame section(s) that match the seating modules of the desired configuration (10 frame sections to choose from in total). We recommend using as few frame sections as possible when creating your own configuration for a clean appearance.

A Frame Corner Section must always be supported by sections in the two open directions.

A configuration with chaise longue modules H98 or I98 must be created using at least 2 sections in total.

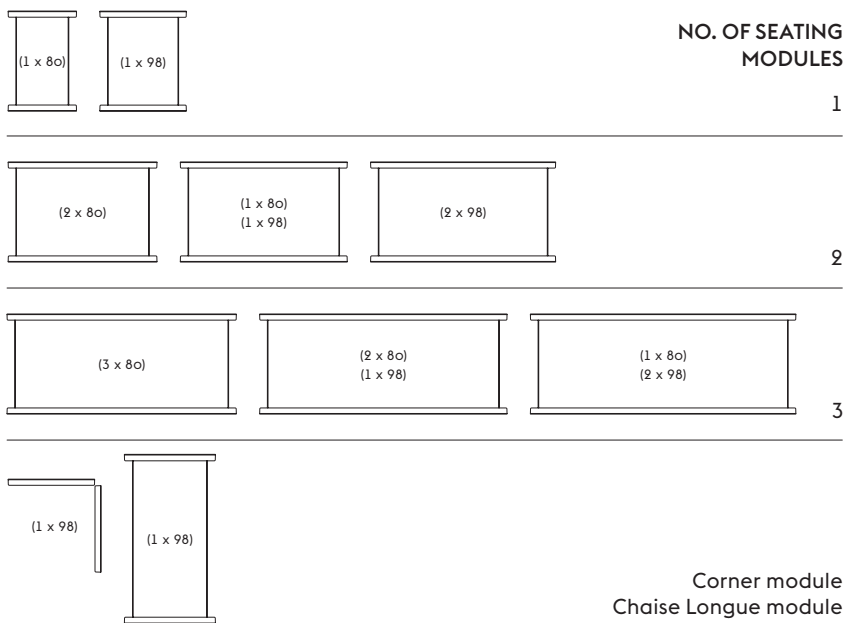

3. LINKING BRACKETS

Identify the amount of linking brackets required to connect the modules in your configuration, following the guidelines below. **Linking brackets must always be used when joining together frame sections.**

Linking brackets must always be mounted on the adjacent sections that face the corner section.

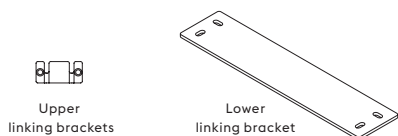

4. CUSHIONS

Specify optional cushions in the desired textile or leather for added comfort and a lounging expression.

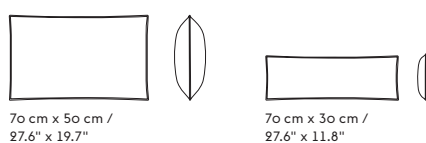

INSPIRATION FOR YOUR CONFIGURATION

2-seater Configurations

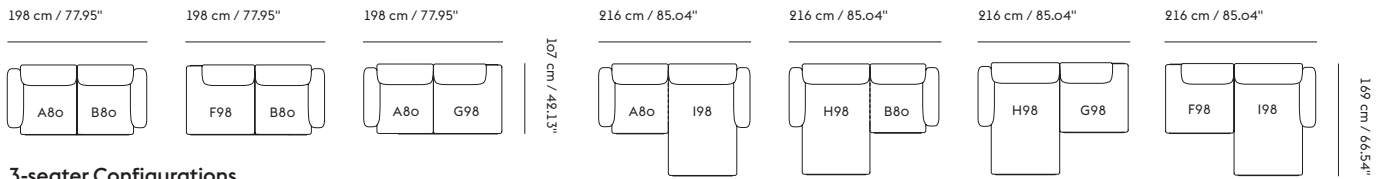

3-seater Configurations

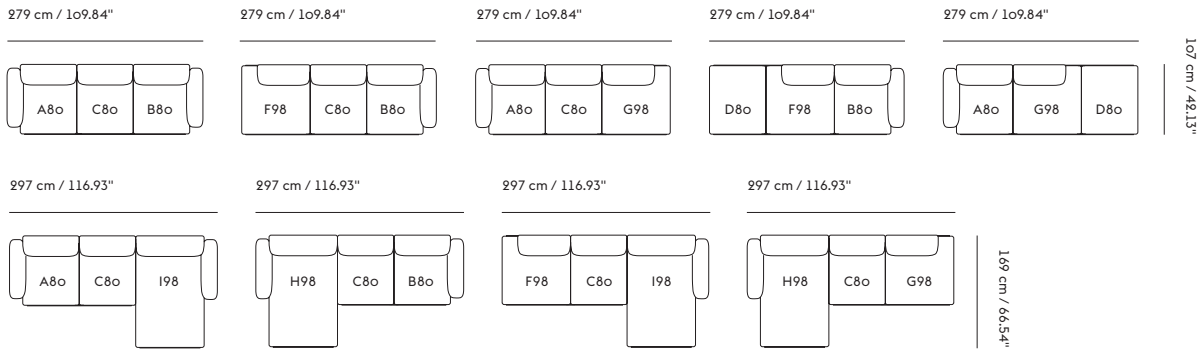

4-seater Configurations

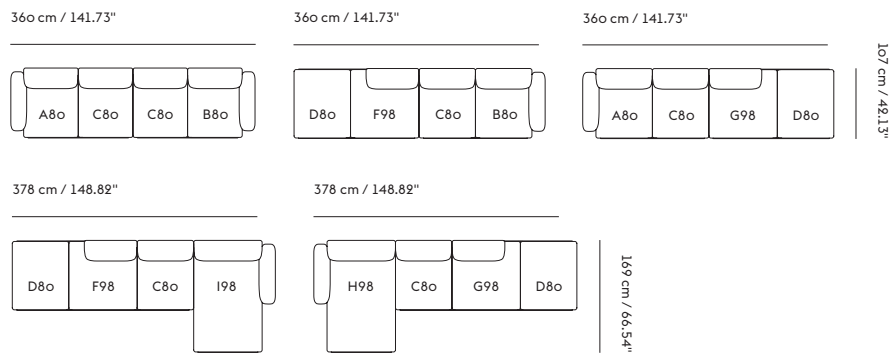

Corner Configurations

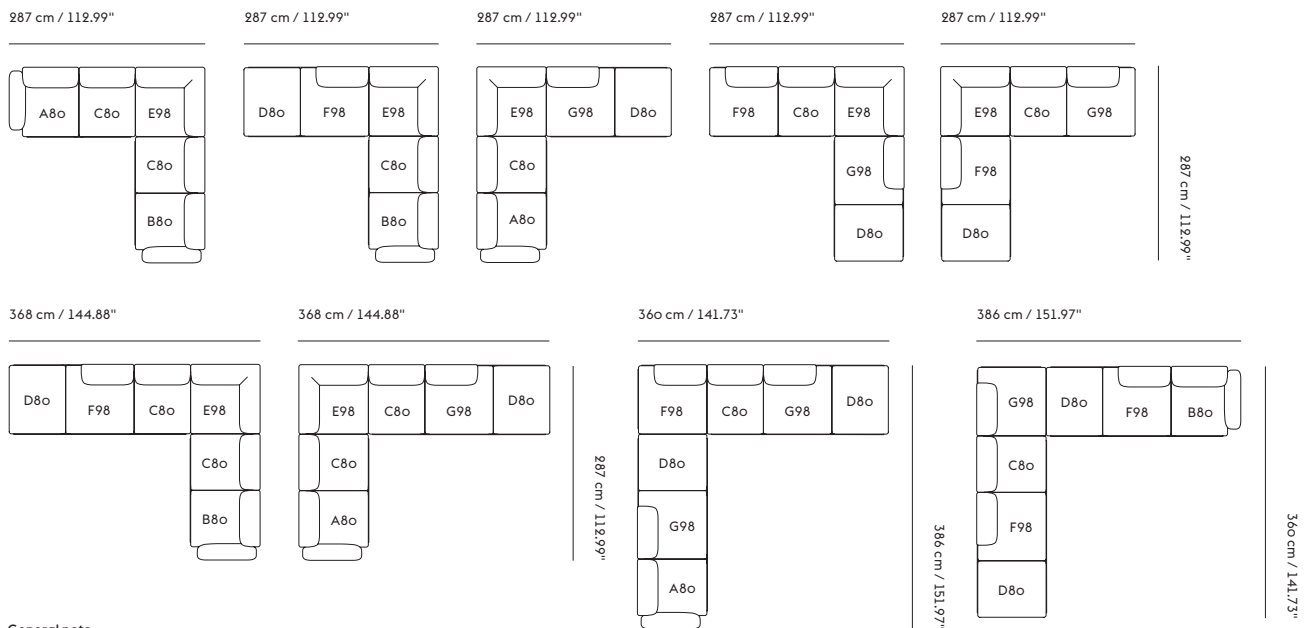

General note

The total dimensions of the configurations are indicative and can vary depending on how close the modules are placed as well as how many modules are combined.

IN SITU MODULAR SOFA / 2-SEATER - CONFIGURATION I

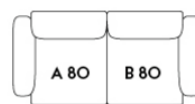

198 cm / 77.95"

107 cm / 42.13"
SD 74 cm / 29.2"

Shipper Colli	3
Gross Weight (kg)	107.3
Net Weight (kg)	80.74
Warranty Period	10 years

Pattern No.	Color	Contract Price	Lead Time
Ready-To-Ship US Warehouse			
MINS2C1-M16180	Frame and Module - Ocean 80/Black	USD 4,251.00	-
MINS2C1-M244912	Frame and Module - Clay 12/Black	USD 5,140.00	-
MINS2C1-M158554	Frame and Module - Vidar 554/Black ***	USD 5,140.00	-
Ready-To-Ship EU Warehouse			
MINS2C1-M10767240	Frame and Module - Ecriture 240/Black	USD 5,140.00	-

IN SITU MODULAR SOFA / 2-SEATER - CONFIGURATION 2



198 cm / 77.95"

107 cm / 42.13"
SD 74 cm / 29.2"

Shipper Colli	3
Gross Weight (kg)	96.2
Net Weight (kg)	76.59
Warranty Period	10 years

Pattern No.	Color	Contract Price	Lead Time
Ready-To-Ship US Warehouse			
MINS2C2-M16180	Frame and Module - Ocean 80/Black	USD 3,880.00	-
MINS2C2-M244912	Frame and Module - Clay 12/Black	USD 4,825.00	-
MINS2C2-M158554	Frame and Module - Vidar 554/Black ***	USD 4,825.00	-
Ready-To-Ship EU Warehouse			
MINS2C2-M10767240	Frame and Module - Ecriture 240/Black	USD 4,825.00	-

IN SITU MODULAR SOFA / 2-SEATER - CONFIGURATION 3



Shipper Colli 3
Gross Weight (kg) 102.4
Net Weight (kg) 76.02
Warranty Period 10 years

Pattern No.	Color	Contract Price	Lead Time
Ready-To-Ship US Warehouse			
MINS2C3-M16180	Frame and Module - Ocean 80/Black	USD 3,880.00	-
MINS2C3-M244912	Frame and Module - Clay 12/Black	USD 4,825.00	-
MINS2C3-M158554	Frame and Module - Vidar 554/Black ***	USD 4,825.00	-
Ready-To-Ship EU Warehouse			
MINS2C3-M10767240	Frame and Module - Ecriture 240/Black	USD 4,825.00	-

IN SITU MODULAR SOFA / 2-SEATER - CONFIGURATION 4

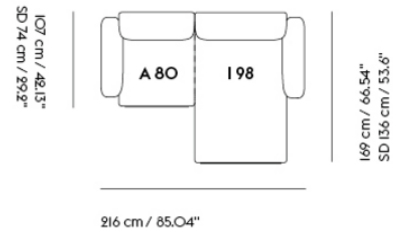

Shipper Colli	5
Gross Weight (kg)	133.8
Net Weight (kg)	103.21
Warranty Period	10 years

Pattern No.	Color	Contract Price	Lead Time
Ready-To-Ship US Warehouse			
MINS2C4-M16180	Frame and Module - Ocean 80/Black	USD 5,035.00	-
MINS2C4-M244912	Frame and Module - Clay 12/Black	USD 6,036.00	-
MINS2C4-M158554	Frame and Module - Vidar 554/Black ***	USD 6,036.00	-
Ready-To-Ship EU Warehouse			
MINS2C4-M10767240	Frame and Module - Ecriture 240/Black	USD 6,036.00	-

IN SITU MODULAR SOFA / 2-SEATER - CONFIGURATION 5

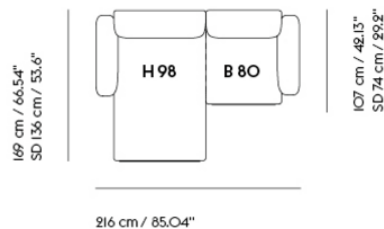
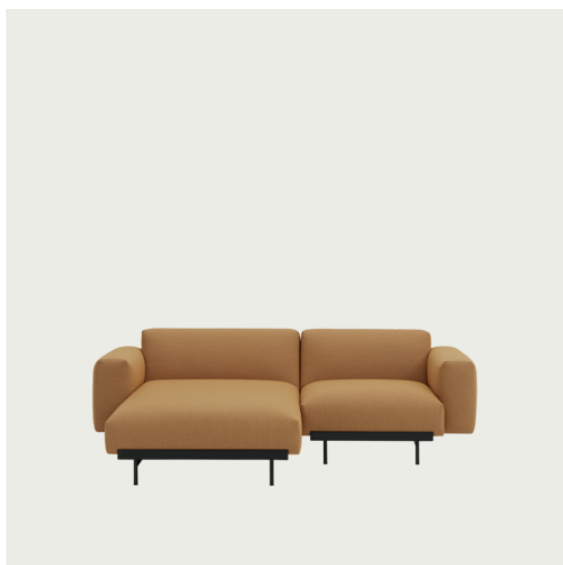

Shipper Colli	5
Gross Weight (kg)	133.8
Net Weight (kg)	103.21
Warranty Period	10 years

Pattern No.	Color	Contract Price	Lead Time
Ready-To-Ship US Warehouse			
MINS2C5-M16180	Frame and Module - Ocean 80/Black	USD 5,035.00	-
MINS2C5-M244912	Frame and Module - Clay 12/Black	USD 6,036.00	-
MINS2C5-M158554	Frame and Module - Vidar 554/Black ***	USD 6,036.00	-
Ready-To-Ship EU Warehouse			
MINS2C5-M10767240	Frame and Module - Ecriture 240/Black	USD 6,036.00	-

IN SITU MODULAR SOFA / 2-SEATER - CONFIGURATION 6

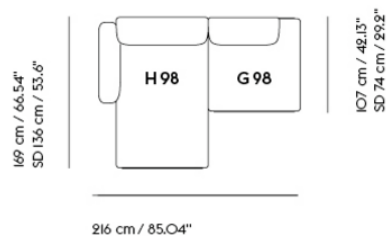

Shipper Colli	5
Gross Weight (kg)	128.9
Net Weight (kg)	98.49
Warranty Period	10 years

Pattern No.	Color	Contract Price	Lead Time
Ready-To-Ship US Warehouse			
MINS2C6-M16180	Frame and Module - Ocean 80/Black	USD 4,671.00	-
MINS2C6-M244912	Frame and Module - Clay 12/Black	USD 5,721.00	-
MINS2C6-M158554	Frame and Module - Vidar 554/Black ***	USD 5,721.00	-
Ready-To-Ship EU Warehouse			
MINS2C6-M10767240	Frame and Module - Ecriture 240/Black	USD 5,721.00	-

IN SITU MODULAR SOFA / 2-SEATER - CONFIGURATION 7

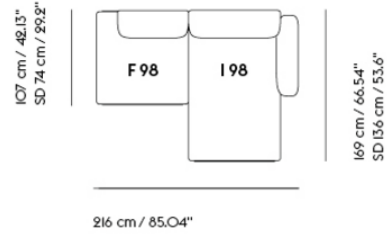

Shipper Colli 5
Gross Weight (kg) 122.7
Net Weight (kg) 99.06
Warranty Period 10 years

Pattern No.	Color	Contract Price	Lead Time
Ready-To-Ship US Warehouse			
MINS2C7-M16180	Frame and Module - Ocean 80/Black	USD 4,671.00	-
MINS2C7-M244912	Frame and Module - Clay 12/Black	USD 5,721.00	-
MINS2C7-M158554	Frame and Module - Vidar 554/Black ***	USD 5,721.00	-
Ready-To-Ship EU Warehouse			
MINS2C7-M10767240	Frame and Module - Ecriture 240/Black	USD 5,721.00	-

IN SITU MODULAR SOFA / 3-SEATER - CONFIGURATION I

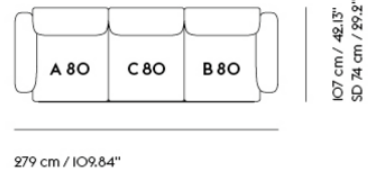

Shipper Colli 4
Gross Weight (kg) 145.5
Net Weight (kg) 110.95
Warranty Period 10 years

Pattern No.	Color	Contract Price	Lead Time
Ready-To-Ship US Warehouse			
MINS3C1-M16180	Frame and Module - Ocean 80/Black	USD 5,721.00	-
MINS3C1-M244912	Frame and Module - Clay 12/Black	USD 6,981.00	-
Ready-To-Ship EU Warehouse			
MINS3C1-M10767240	Frame and Module - Ecriture 240/Black	USD 6,981.00	-

IN SITU MODULAR SOFA / 3-SEATER - CONFIGURATION 2

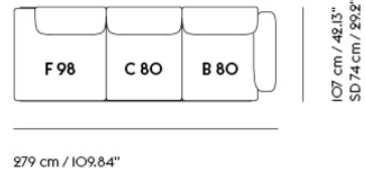

Shipper Colli 4
Gross Weight (kg) 134.3
Net Weight (kg) 106.7
Warranty Period 10 years

Pattern No.	Color	Contract Price	Lead Time
Ready-To-Ship US Warehouse			
MINS3C2-M16180	Frame and Module - Ocean 80/Black	USD 5,350.00	-
MINS3C2-M244912	Frame and Module - Clay 12/Black	USD 6,610.00	-
Ready-To-Ship EU Warehouse			
MINS3C2-M10767240	Frame and Module - Ecriture 240/Black	USD 6,610.00	-

IN SITU MODULAR SOFA / 3-SEATER - CONFIGURATION 3

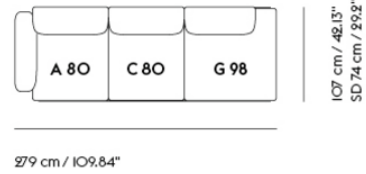

Shipper Colli 4
Gross Weight (kg) 140.5
Net Weight (kg) 106.13
Warranty Period 10 years

Pattern No.	Color	Contract Price	Lead Time
Ready-To-Ship US Warehouse			
MINS3C3-M16180	Frame and Module - Ocean 80/Black	USD 5,350.00	-
MINS3C3-M244912	Frame and Module - Clay 12/Black	USD 6,610.00	-
Ready-To-Ship EU Warehouse			
MINS3C3-M10767240	Frame and Module - Ecriture 240/Black	USD 6,610.00	-

IN SITU MODULAR SOFA / 3-SEATER - CONFIGURATION 4

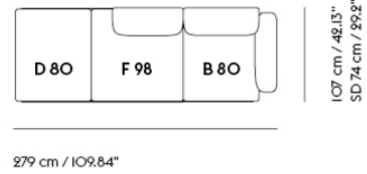

Shipper Colli 4
Gross Weight (kg) 122.2
Net Weight (kg) 95.07
Warranty Period 10 years

Pattern No.	Color	Contract Price	Lead Time
Ready-To-Ship US Warehouse			
MINS3C4-M16180	Frame and Module - Ocean 80/Black	USD 4,825.00	-
MINS3C4-M244912	Frame and Module - Clay 12/Black	USD 5,980.00	-
MINS3C4-M158554	Frame and Module - Vidar 554/Black ***	USD 5,980.00	-
Ready-To-Ship EU Warehouse			
MINS3C4-M10767240	Frame and Module - Ecriture 240/Black	USD 5,980.00	-

IN SITU MODULAR SOFA / 3-SEATER - CONFIGURATION 5

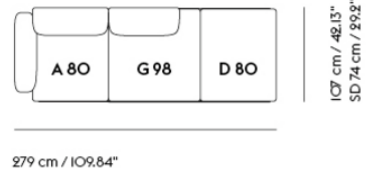

Shipper Colli 4
Gross Weight (kg) 128.4
Net Weight (kg) 94.5
Warranty Period 10 years

Pattern No.	Color	Contract Price	Lead Time
Ready-To-Ship US Warehouse			
MINS3C5-M16180	Frame and Module - Ocean 80/Black	USD 4,825.00	-
MINS3C5-M244912	Frame and Module - Clay 12/Black	USD 5,980.00	-
MINS3C5-M158554	Frame and Module - Vidar 554/Black ***	USD 5,980.00	-
Ready-To-Ship EU Warehouse			
MINS3C5-M1076240	Frame and Module - Ecriture 240/Black	USD 5,980.00	-

IN SITU MODULAR SOFA / 3-SEATER - CONFIGURATION 6

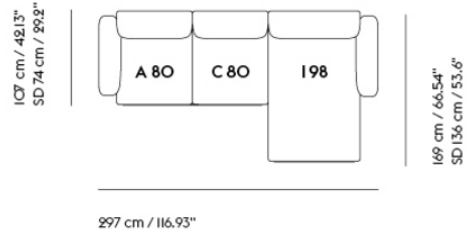

Shipper Colli 6
Gross Weight (kg) 171.9
Net Weight (kg) 133.22
Warranty Period 10 years

Pattern No.	Color	Contract Price	Lead Time
Ready-To-Ship US Warehouse			
MINS3C6-M16180	Frame and Module - Ocean 80/Black	USD 6,505.00	-
MINS3C6-M244912	Frame and Module - Clay 12/Black	USD 7,821.00	-
Ready-To-Ship EU Warehouse			
MINS3C6-M10767240	Frame and Module - Ecriture 240/Black	USD 7,821.00	-

IN SITU MODULAR SOFA / 3-SEATER - CONFIGURATION 7

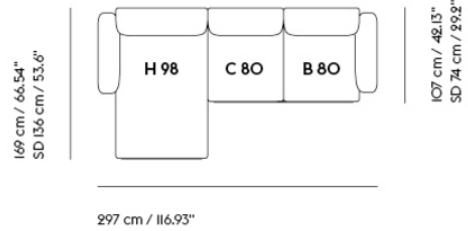

Shipper Colli 6
Gross Weight (kg) 171.9
Net Weight (kg) 133.22
Warranty Period 10 years

Pattern No.	Color	Contract Price	Lead Time
Ready-To-Ship US Warehouse			
MINS3C7-M16180	Frame and Module - Ocean 80/Black	USD 6,505.00	-
MINS3C7-M244912	Frame and Module - Clay 12/Black	USD 7,821.00	-
Ready-To-Ship EU Warehouse			
MINS3C7-M10767240	Frame and Module - Ecriture 240/Black	USD 7,821.00	-

IN SITU MODULAR SOFA / 3-SEATER - CONFIGURATION 8

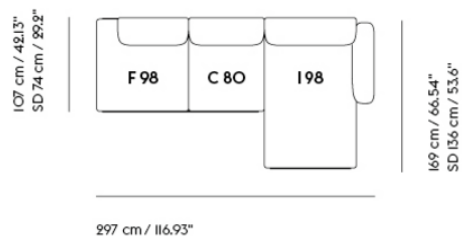

Shipper Colli	6
Gross Weight (kg)	160.8
Net Weight (kg)	129.07
Warranty Period	10 years

Pattern No.	Color	Contract Price	Lead Time
Ready-To-Ship US Warehouse			
MINS3C8-M16180	Frame and Module - Ocean 80/Black	USD 6,141.00	-
MINS3C8-M244912	Frame and Module - Clay 12/Black	USD 7,506.00	-
Ready-To-Ship EU Warehouse			
MINS3C8-M10767240	Frame and Module - Ecriture 240/Black	USD 7,506.00	-

IN SITU MODULAR SOFA / 3-SEATER - CONFIGURATION 9

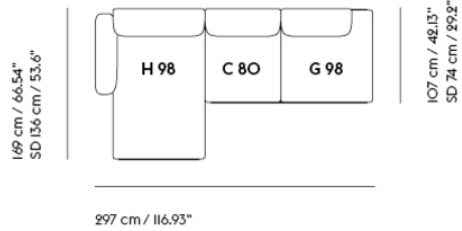

Shipper Colli 6
Gross Weight (kg) 167
Net Weight (kg) 128.5
Warranty Period 10 years

Pattern No.	Color	Contract Price	Lead Time
Ready-To-Ship US Warehouse			
MINS3C9-M16180	Frame and Module - Ocean 80/Black	USD 6,141.00	-
MINS3C9-M244912	Frame and Module - Clay 12/Black	USD 7,506.00	-
Ready-To-Ship EU Warehouse			
MINS3C9-M10767240	Frame and Module - Ecriture 240/Black	USD 7,506.00	-

IN SITU MODULAR SOFA / 4-SEATER - CONFIGURATION I

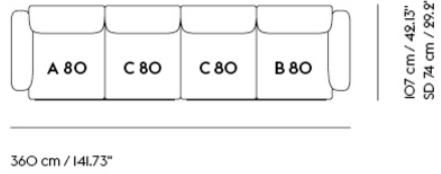

Shipper Colli 7
Gross Weight (kg) 191.2
Net Weight (kg) 147.5
Warranty Period 10 years

Pattern No.	Color	Contract Price	Lead Time
Ready-To-Ship US Warehouse			
MINS4C1-M16180	Frame and Module - Ocean 80/Black	USD 7,345.00	-
MINS4C1-M244912	Frame and Module - Clay 12/Black	USD 8,976.00	-
Ready-To-Ship EU Warehouse			
MINS4C1-M10767240	Frame and Module - Ecriture 240/Black	USD 8,976.00	-

IN SITU MODULAR SOFA / 4-SEATER - CONFIGURATION 2

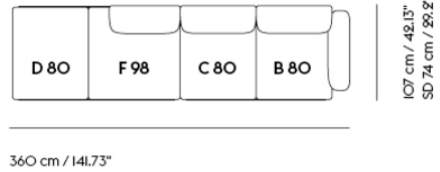

Shipper Colli 7
 Gross Weight (kg) 168
 Net Weight (kg) 131.72
 Warranty Period 10 years

Pattern No.	Color	Contract Price	Lead Time
Ready-To-Ship US Warehouse			
MINS4C2-M16180	Frame and Module - Ocean 80/Black	USD 6,561.00	-
MINS4C2-M244912	Frame and Module - Clay 12/Black	USD 7,975.00	-
Ready-To-Ship EU Warehouse			
MINS4C2-M10767240	Frame and Module - Ecriture 240/Black	USD 7,975.00	-

IN SITU MODULAR SOFA / 4-SEATER - CONFIGURATION 3

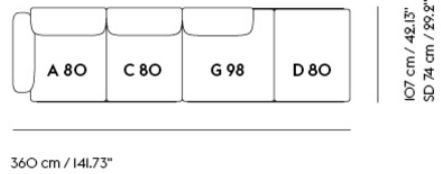

Shipper Colli 7
Gross Weight (kg) 174.2
Net Weight (kg) 131.15
Warranty Period 10 years

Pattern No.	Color	Contract Price	Lead Time
Ready-To-Ship US Warehouse			
MINS4C3-M16180	Frame and Module - Ocean 80/Black	USD 6,561.00	-
MINS4C3-M244912	Frame and Module - Clay 12/Black	USD 7,975.00	-
Ready-To-Ship EU Warehouse			
MINS4C3-M10767240	Frame and Module - Ecriture 240/Black	USD 7,975.00	-

IN SITU MODULAR SOFA / 4-SEATER - CONFIGURATION 4

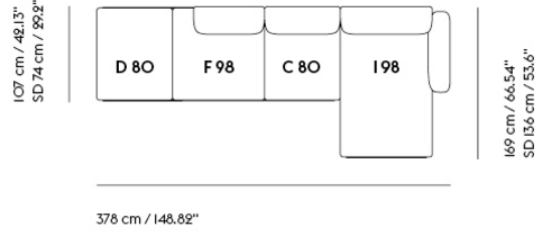

Shipper Colli 7
 Gross Weight (kg) 186.8
 Net Weight (kg) 147.55
 Warranty Period 10 years

Pattern No.	Color	Contract Price	Lead Time
Ready-To-Ship US Warehouse			
MINS4C4-M16180	Frame and Module - Ocean 80/Black	USD 7,191.00	-
MINS4C4-M244912	Frame and Module - Clay 12/Black	USD 8,710.00	-
Ready-To-Ship EU Warehouse			
MINS4C4-M10767240	Frame and Module - Ecriture 240/Black	USD 8,710.00	-

IN SITU MODULAR SOFA / 4-SEATER - CONFIGURATION 5

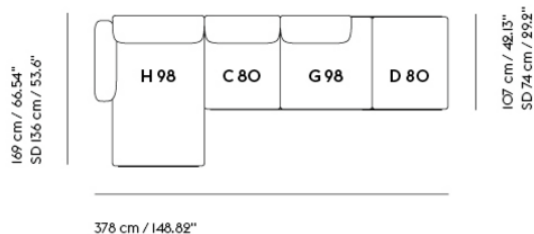

Shipper Colli	7
Gross Weight (kg)	193
Net Weight (kg)	146.98
Warranty Period	10 years

Pattern No.	Color	Contract Price	Lead Time
Ready-To-Ship US Warehouse			
MINS4C5-M16180	Frame and Module - Ocean 80/Black	USD 7,191.00	-
MINS4C5-M244912	Frame and Module - Clay 12/Black	USD 8,710.00	-
Ready-To-Ship EU Warehouse			
MINS4C5-M10767240	Frame and Module - Ecriture 240/Black	USD 8,710.00	-

IN SITU MODULAR SOFA / CORNER - CONFIGURATION I

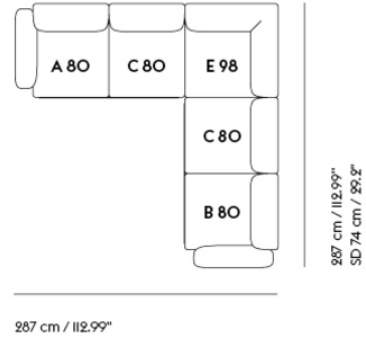

Shipper Colli IO
Gross Weight (kg) 249.4
Net Weight (kg) 192.2
Warranty Period IO years

Pattern No.	Color	Contract Price	Lead Time
Ready-To-Ship US Warehouse			
MINSPPCC1-M16180	Frame and Module - Ocean 80/Black	USD 9,186.00	-
MINSPPCC1-M244912	Frame and Module - Clay 12/Black	USD 11,545.00	-
Ready-To-Ship EU Warehouse			
MINSPPCC1-M10767240	Frame and Module - Ecriture 240/Black	USD 11,545.00	-

IN SITU MODULAR SOFA / CORNER - CONFIGURATION 2

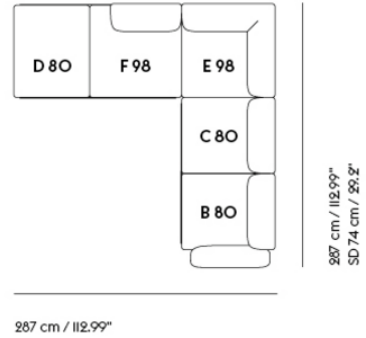

Shipper Colli IO
Gross Weight (kg) 226.2
Net Weight (kg) 176.42
Warranty Period IO years

Pattern No.	Color	Contract Price	Lead Time
Ready-To-Ship US Warehouse			
MINSPSCC2-M16180	Frame and Module - Ocean 80/Black	USD 8,290.00	-
MINSPSCC2-M244912	Frame and Module - Clay 12/Black	USD 10,180.00	-
MINSPSCC2-M158554	Frame and Module - Vidar 554/Black ***	USD 10,180.00	-
Ready-To-Ship EU Warehouse			
MINSPSCC2-M10767240	Frame and Module - Ecriture 240/Black	USD 10,180.00	-

IN SITU MODULAR SOFA / CORNER - CONFIGURATION 3

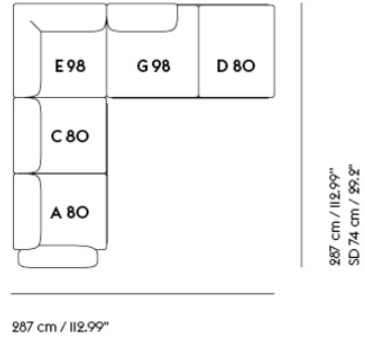

Shipper Colli IO
 Gross Weight (kg) 232.4
 Net Weight (kg) 175.85
 Warranty Period IO years

Pattern No.	Color	Contract Price	Lead Time
Ready-To-Ship US Warehouse			
MINSPPCC3-M16180	Frame and Module - Ocean 80/Black	USD 8,290.00	-
MINSPPCC3-M244912	Frame and Module - Clay 12/Black	USD 10,180.00	-
Ready-To-Ship EU Warehouse			
MINSPPCC3-M10767240	Frame and Module - Ecriture 240/Black	USD 10,180.00	-

IN SITU MODULAR SOFA / CORNER - CONFIGURATION 4

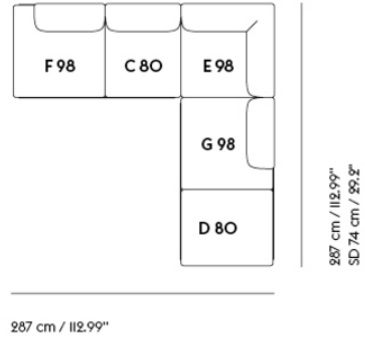

Shipper Colli IO
Gross Weight (kg) 221.3
Net Weight (kg) 171.7
Warranty Period 10 years

Pattern No.	Color	Contract Price	Lead Time
Ready-To-Ship US Warehouse			
MINSPPCC4-M16180	Frame and Module - Ocean 80/Black	USD 7,975.00	-
MINSPPCC4-M244912	Frame and Module - Clay 12/Black	USD 9,816.00	-
Ready-To-Ship EU Warehouse			
MINSPPCC4-M10767240	Frame and Module - Ecriture 240/Black	USD 9,816.00	-

IN SITU MODULAR SOFA / CORNER - CONFIGURATION 5



Shipper Colli IO
Gross Weight (kg) 221.3
Net Weight (kg) 171.7
Warranty Period 10 years

Pattern No.	Color	Contract Price	Lead Time
Ready-To-Ship US Warehouse			
MINSPPCC5-M16180	Frame and Module - Ocean 80/Black	USD 7,975.00	-
MINSPPCC5-M244912	Frame and Module - Clay 12/Black	USD 9,816.00	-
Ready-To-Ship EU Warehouse			
MINSPPCC5-M10767240	Frame and Module - Ecriture 240/Black	USD 9,816.00	-

IN SITU MODULAR SOFA / CORNER - CONFIGURATION 6

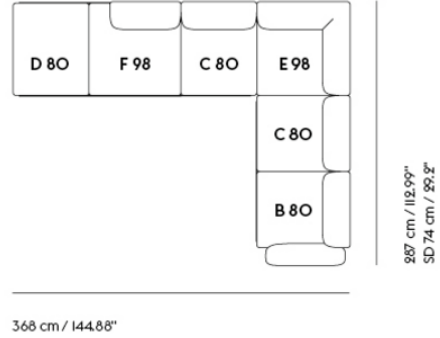

Shipper Colli II
Gross Weight (kg) 264.3
Net Weight (kg) 206.53
Warranty Period 10 years

Pattern No.	Color	Contract Price	Lead Time
Ready-To-Ship US Warehouse			
MINSPSCC6-M16180	Frame and Module - Ocean 80/Black	USD 9,760.00	-
MINSPSCC6-M244912	Frame and Module - Clay 12/Black	USD 12,070.00	-
Ready-To-Ship EU Warehouse			
MINSPSCC6-M10767240	Frame and Module - Ecriture 240/Black	USD 12,070.00	-

IN SITU MODULAR SOFA / CORNER - CONFIGURATION 7

200

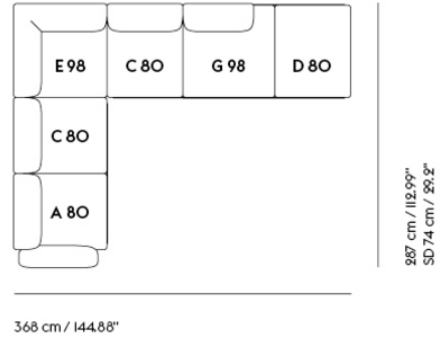

Shipper Colli	11
Gross Weight (kg)	270.5
Net Weight (kg)	205.96
Warranty Period	10 years

Pattern No.	Color	Contract Price	Lead Time
Ready-To-Ship US Warehouse			
MINSPSCC7-M16180	Frame and Module - Ocean 80/Black	USD 9,760.00	-
MINSPSCC7-M244912	Frame and Module - Clay 12/Black	USD 12,070.00	-
Ready-To-Ship EU Warehouse			
MINSPSCC7-M10767240	Frame and Module - Ecriture 240/Black	USD 12,070.00	-

IN SITU MODULAR SOFA / CORNER - CONFIGURATION 8

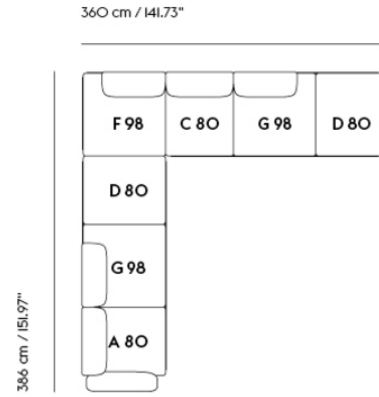

Shipper Colli 12
Gross Weight (kg) 288.5
Net Weight (kg) 218.46
Warranty Period 10 years

Pattern No.	Color	Contract Price	Lead Time
Ready-To-Ship US Warehouse			
MINSPPCC8-M16180	Frame and Module - Ocean 80/Black	USD 11,020.00	-
MINSPPCC8-M244912	Frame and Module - Clay 12/Black	USD 13,645.00	-
Ready-To-Ship EU Warehouse			
MINSPPCC8-M10767240	Frame and Module - Ecriture 240/Black	USD 13,645.00	-

IN SITU MODULAR SOFA / CORNER - CONFIGURATION 9

202

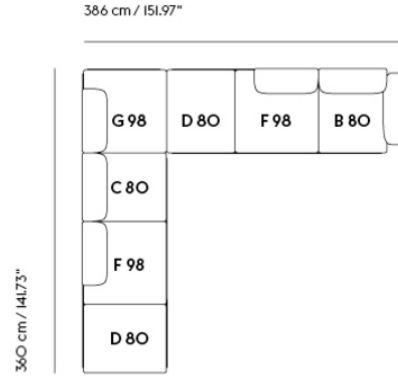

Shipper Colli	12
Gross Weight (kg)	282.3
Net Weight (kg)	219.03
Warranty Period	10 years

Pattern No.	Color	Contract Price	Lead Time
Ready-To-Ship US Warehouse			
MINSPSCC9-M16180	Frame and Module - Ocean 80/Black	USD 11,020.00	-
MINSPSCC9-M244912	Frame and Module - Clay 12/Black	USD 13,645.00	-
Ready-To-Ship EU Warehouse			
MINSPSCC9-M10767240	Frame and Module - Ecriture 240/Black	USD 13,645.00	-

IN SITU MODULAR SOFA / LEFT ARMREST MODULE (A80)

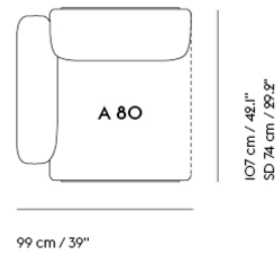

Shipper Colli	1
Gross Weight (kg)	42.7
Net Weight (kg)	31.25
Please note	This product features an armrest on the left-hand side when facing the product from the front.
Please note	This variant is a Seating Module only and does not include a Frame Section.
Warranty Period	10 years

Pattern No.	Color	Contract Price	Lead Time
Ready-To-Ship US Warehouse			
MINSAML-M16180	Ocean 80	USD 1,941.00	-
MINSAML-M244912	Clay 12	USD 2,410.00	-
MINSAML-M158554	Vidar 554	USD 2,410.00	-
Ready-To-Ship EU Warehouse			
MINSAML-M10767240	Ecriture 240	USD 2,410.00	-
Extras			
MLEAKIT	Leather care set for Refine Leather	USD 27.00	-

IN SITU MODULAR SOFA / RIGHT ARMREST MODULE (B80)

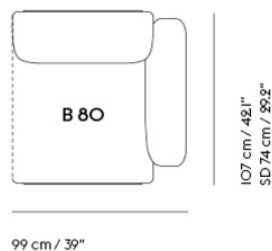
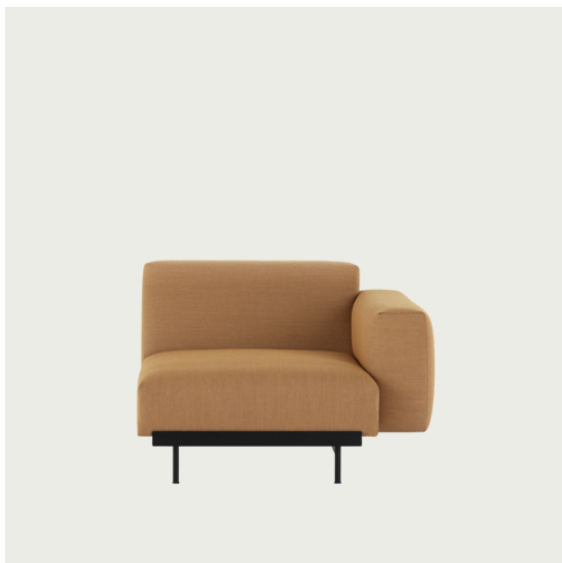

Shipper Colli	1
Gross Weight (kg)	42.7
Net Weight (kg)	31.25
Please note	This product features an armrest on the right-hand side when facing the product from the front.
Please note	This variant is a Seating Module only and does not include a Frame Section.
Warranty Period	10 years

Pattern No.	Color	Contract Price	Lead Time
Ready-To-Ship US Warehouse			
MINSAMR-M16180	Ocean 80	USD 1,941.00	-
MINSAMR-M244912	Clay 12	USD 2,410.00	-
MINSAMR-M158554	Vidar 554	USD 2,410.00	-
Ready-To-Ship EU Warehouse			
MINSAMR-M10767240	Ecriture 240	USD 2,410.00	-
Extras			
MLEAKIT	Leather care set for Refine Leather	USD 27.00	-

IN SITU MODULAR SOFA / CENTRE MODULE (C80)

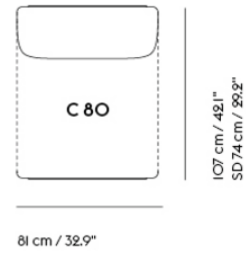
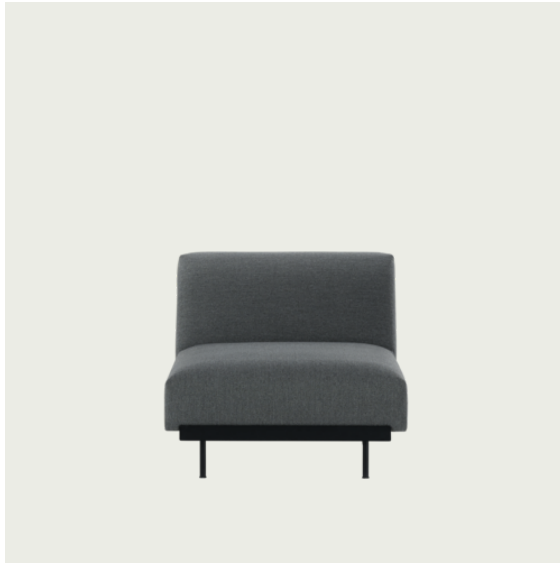

Shipper Colli	1
Gross Weight (kg)	30.2
Net Weight (kg)	23.53
Please note	This variant is a Seating Module only and does not include a Frame Section.
Warranty Period	10 years

Pattern No.	Color	Contract Price	Lead Time
Ready-To-Ship US Warehouse			
MINSCTM-M16180	Ocean 80	USD 1,416.00	-
MINSCTM-M244912	Clay 12	USD 1,731.00	-
MINSCTM-M158554	Vidar 554 ***	USD 1,731.00	-
Ready-To-Ship EU Warehouse			
MINSCTM-M10767240	Ecriture 240	USD 1,731.00	-
Extras			
MLEAKIT	Leather care set for Refine Leather	USD 27.00	-

IN SITU MODULAR SOFA / OTTOMAN MODULE (D80)

206

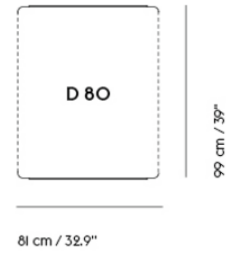

Shipper Colli	1
Gross Weight (kg)	18.1
Net Weight (kg)	11.9
Please note	This variant is a Seating Module only and does not include a Frame Section.
Warranty Period	10 years

Pattern No.	Color	Contract Price	Lead Time
Ready-To-Ship US Warehouse			
MINSOTM-M16180	Ocean 80	USD 881.00	-
MINSOTM-M244912	Clay 12	USD 1,101.00	-
MINSOTM-M158554	Vidar 554	USD 1,101.00	-
Ready-To-Ship EU Warehouse			
MINSOTM-M10767240	Ecriture 240	USD 1,101.00	-
Extras			
MLEAKIT	Leather care set for Refine Leather	USD 27.00	-

IN SITU MODULAR SOFA / CORNER MODULE (E98)

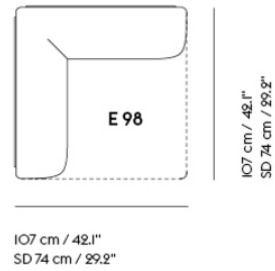

Shipper Colli	1
Gross Weight (kg)	45.8
Net Weight (kg)	34.68
Please note	This variant is a Seating Module only and does not include a Frame Section.
Warranty Period	10 years

Pattern No.	Color	Contract Price	Lead Time
Ready-To-Ship US Warehouse			
MINSCOM-M16180	Ocean 80	USD 1,570.00	-
MINSCOM-M244912	Clay 12	USD 2,046.00	-
MINSCOM-M158554	Vidar 554	USD 2,046.00	-
Ready-To-Ship EU Warehouse			
MINSCOM-M10767240	Ecriture 240	USD 2,046.00	-
Extras			
MLEAKIT	Leather care set for Refine Leather	USD 27.00	-

IN SITU MODULAR SOFA / LEFT OPEN-ENDED MODULE (F98)

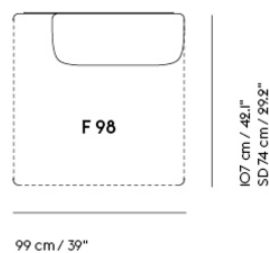
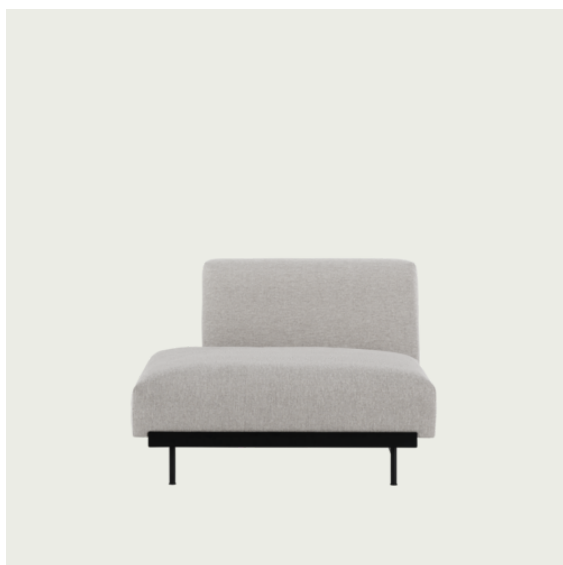

Shipper Colli	1
Gross Weight (kg)	30.2
Net Weight (kg)	25.7
Please note	This product features an open end on the left-hand side when facing the product from the front.
Please note	This variant is a Seating Module only and does not include a Frame Section.
Warranty Period	10 years

Pattern No.	Color	Contract Price	Lead Time
Ready-To-Ship US Warehouse			
MINSOEML-M16180	Ocean 80	USD 1,626.00	-
MINSOEML-M244912	Clay 12	USD 2,095.00	-
MINSOEML-M158554	Vidar 554	USD 2,095.00	-
Ready-To-Ship EU Warehouse			
MINSOEML-M10767240	Ecriture 240	USD 2,095.00	-
Extras			
MLEAKIT	Leather care set for Refine Leather	USD 27.00	-

IN SITU MODULAR SOFA / RIGHT OPEN-ENDED MODULE (G98)

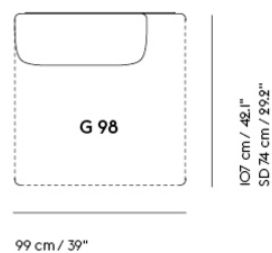
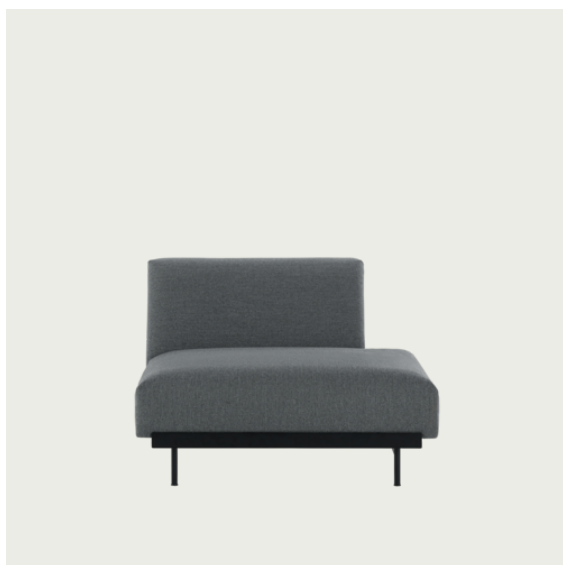

Shipper Colli	1
Gross Weight (kg)	36.4
Net Weight (kg)	25.13
Please note	This product features an open end on the right-hand side when facing the product from the front.
Please note	This variant is a Seating Module only and does not include a Frame Section.
Warranty Period	10 years

Pattern No.	Color	Contract Price	Lead Time
Ready-To-Ship US Warehouse			
MINSOEMR-M16180	Ocean 80	USD 1,626.00	-
MINSOEMR-M244912	Clay 12	USD 2,095.00	-
MINSOEMR-M158554	Vidar 554	USD 2,095.00	-
Ready-To-Ship EU Warehouse			
MINSOEMR-M10767240	Ecriture 240	USD 2,095.00	-
Extras			
MLEAKIT	Leather care set for Refine Leather	USD 27.00	-

IN SITU MODULAR SOFA / LEFT ARMREST LOUNGE MODULE (H98)

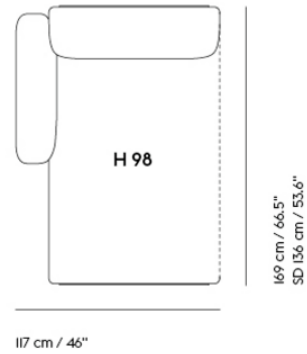

- Shipper Colli** | 1
- Gross Weight (kg)** 55.8
- Net Weight (kg)** 42.7
- Please note** This product features an armrest on the left-hand side when facing the product from the front.
- Please note** This variant is a Seating Module only and does not include a Frame Section.
- Warranty Period** 10 years

Pattern No.	Color	Contract Price	Lead Time
Ready-To-Ship US Warehouse			
MINSALML-M16180	Ocean 80	USD 2,571.00	-
MINSALML-M244912	Clay 12	USD 3,096.00	-
MINSALML-M158554	Vidar 554	USD 3,096.00	-
Ready-To-Ship EU Warehouse			
MINSALML-M10767240	Ecriture 240	USD 3,096.00	-
Extras			
MLEAKIT	Leather care set for Refine Leather	USD 27.00	-

IN SITU MODULAR SOFA / RIGHT ARMREST LOUNGE MODULE (I98)

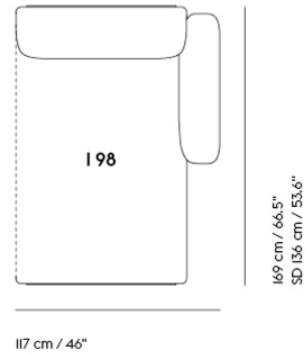

Shipper Colli	1
Gross Weight (kg)	55.8
Net Weight (kg)	42.7
Please note	This product features an armrest on the right-hand side when facing the product from the front.
Please note	This variant is a Seating Module only and does not include a Frame Section.
Warranty Period	10 years

Pattern No.	Color	Contract Price	Lead Time
Ready-To-Ship US Warehouse			
MINSALMR-M16180	Ocean 80	USD 2,571.00	-
MINSALMR-M244912	Clay 12	USD 3,096.00	-
MINSALMR-M158554	Vidar 554	USD 3,096.00	-
Ready-To-Ship EU Warehouse			
MINSALMR-M10767240	Ecriture 240	USD 3,096.00	-
Extras			
MLEAKIT	Leather care set for Refine Leather	USD 27.00	-

IN SITU MODULAR SOFA / CUSHION — 70 X 30 CM / 27.6 X 11.8"

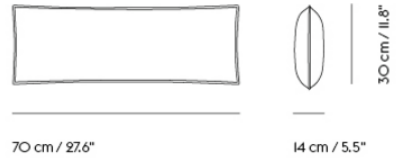

Shipper Colli 1
Gross Weight (kg) 0.8
Net Weight (kg) 0.8
Warranty Period 10 years

Pattern No.	Color	Contract Price	Lead Time
Ready-To-Ship US Warehouse			
MINSCUS2610-M16180	Ocean 80	USD 167.00	-
MINSCUS2610-M244912	Clay 12	USD 257.00	-
MINSCUS2610-M158554	Vidar 554	USD 257.00	-
Extras			
MLEAKIT	Leather care set for Refine Leather	USD 27.00	-

**IN SITU MODULAR SOFA / CUSHION —
70 X 50 CM / 27.6 X 19.7"**

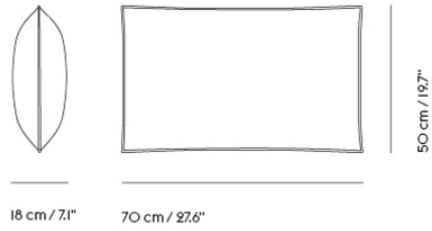

Shipper Colli 1
 Gross Weight (kg) 1.75
 Net Weight (kg) 1.75
 Warranty Period 10 years

Pattern No.	Color	Contract Price	Lead Time
Ready-To-Ship US Warehouse			
MINSCUS2618-M16180	Ocean 80	USD 226.00	-
MINSCUS2618-M244912	Clay 12	USD 310.00	-
MINSCUS2618-M158554	Vidar 554	USD 310.00	-
Extras			
MLEAKIT	Leather care set for Refine Leather	USD 27.00	-

IN SITU MODULAR SOFA INDIVIDUAL PARTS



All Variants

	Description	Pattern No.	Contract Price
In Situ Frames - Straight	1x80	M-INSFRM-S-80	289
	1x98	M-INSFRM-S-98	289
	2x80	M-INSFRM-S-8080	576
	2x98	M-INSFRM-S-9898	576
	3x80	M-INSFRM-S-808080	866
	1x80 + 1x98	M-INSFRM-S-8098	576
	1x80 + 2x98	M-INSFRM-S-809898	866
	2x80 + 1x98	M-INSFRM-S-808098	866
In Situ Frames - Chaise	1x98	M-INSFRM-L-98	289
In Situ Frames - Corner	1x98	M-INSFRM-C-98	289
In Situ Linking Bracket		M-LD-INSU	39

	Description	Pattern No.	Upholstery Grades								
			COM								
			A	B	C	E	R	T	U	V	W
In Situ Armrest Module	Left (A80)	M-INSAM-L	1,941	2,151	2,361	2,410	3,411	3,775	4,251	4,510	4,881
	Right (B80)	M-INSAM-R	1,941	2,151	2,361	2,410	3,411	3,775	4,251	4,510	4,881
In Situ Center Module	Centre (C80)	M-INSCTM	1,416	1,570	1,626	1,731	2,410	2,676	2,935	3,145	3,355
In Situ Ottoman Module	Ottoman (D80)	M-INSOTM	881	971	1,013	1,101	1,626	1,836	2,046	2,095	2,151
In Situ Corner Module	Corner (E98)	M-INSCOM	1,570	1,731	1,885	2,046	3,621	3,985	4,405	4,671	4,986
In Situ Open-Ended Module	Left (F98)	M-INSOEM-L	1,626	1,836	2,046	2,095	2,886	3,145	3,516	3,775	3,985
	Right (G98)	M-INSOEM-R	1,626	1,836	2,046	2,095	2,886	3,145	3,516	3,775	3,985
In Situ Armrest Lounge Module	Left (H98)	M-INSALM-L	2,571	2,830	2,935	3,096	4,825	5,301	5,826	6,295	6,610
	Right (I98)	M-INSALM-R	2,571	2,830	2,935	3,096	4,825	5,301	5,826	6,295	6,610
In Situ Cushion	27.6" x 11.8"	M-INSCUS-2610	167	198	236	257	394	450	597	555	587
	27.6" x 19.7"	M-INSCUS-2618	226	236	289	310	660	719	929	950	982

Upholstery Options

A	B	C	E	R	T	U	V	W
Ocean (M161)* Remix (M156)	Beck (M6376) Fiord (M155) Grain (M12659) Manner (M12665) Re-Wool (M4586) Sabi (M8404)	Hallingdal (M146)	Acca (M12660) Clay (M2449) Divina (M150) Divina MD (M147) Divina Melange (M135) Ecriture (M10767) Hearth (M12664) Twill Weave (M142) Vidar (M158)	Easy Leather (M141)	Refine Leather (M136)	Endure Leather (M137)	Grace Leather (M12374)	Allure Leather (M12375)

*Notes:
Ocean - Color 3, 21, 32, 50, 52, 80 & 601
Clay - Color 1, 2, 3, 4, 5, 6, 7, 8, 9, 10, 11, 12, 13, 14, 15, 16 & 17

HOW TO CONFIGURE

See the In Situ intro page for how to configure or use the online planner on: planner.muuto.com/in-situ

LINEAR STEEL SERIES

FOR MORE INFORMATION,
EXPLORE BELOW

- ↗ [Product Fact Sheet](#)
- ↗ [Images](#)
- ↗ [Architect Files](#)
- ↗ [Assembly Instructions](#)
- ↗ [Product Declaration](#)

LINEAR STEEL TABLE / 140 X 75 CM / 55.1 X 29.5"

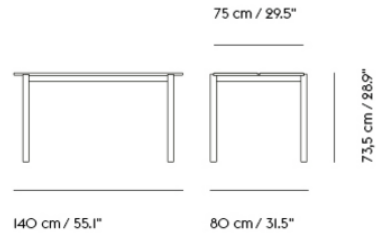

Shipper Colli 3
Gross Weight (kg) 46.25
Net Weight (kg) 40
Warranty Period 10 years

Pattern No.	Color	Contract Price	Lead Time
Ready-To-Ship US Warehouse			
MLINST5530-BLCK	Anthracite Black	USD 1,675.00	-
MLINST5530-BORG	Burnt Orange	USD 1,675.00	-
MLINST5530-DKGN	Dark Green	USD 1,675.00	-
MLINST5530-GREY	Grey	USD 1,675.00	-
MLINST5530-PABU	Pale Blue	USD 1,675.00	-
MLINST5530-WGST	Warm Galvanized Steel	USD 1,885.00	-
Extras			
MLINSG	Plastic glides for Linear Steel Table and Bench - Black ***	USD 21.00	-
MLINSS	Adjustable Feet for Linear Steel Table & Bench	USD 34.00	-
MLINSM	Linear Steel Ground Mounting Kit	USD 142.00	-
MLINSC5530	Outdoor Cover for Linear Steel Table 140 x 75 CM / 55.1 x 29.5	USD 167.00	-

LINEAR STEEL TABLE / 200 X 75 CM / 78.7 X 29.5"

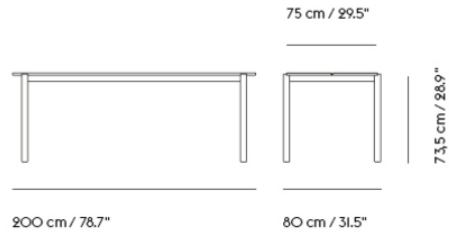

Shipper Colli	3
Gross Weight (kg)	58.35
Net Weight (kg)	51
Warranty Period	10 years

Pattern No.	Color	Contract Price	Lead Time
Ready-To-Ship US Warehouse			
MLINST5530-BLCK	Anthracite Black	USD 1,675.00	-
MLINST5530-BORG	Burnt Orange	USD 1,675.00	-
MLINST5530-DKGN	Dark Green	USD 1,675.00	-
MLINST5530-GREY	Grey	USD 1,675.00	-
MLINST5530-PABU	Pale Blue	USD 1,675.00	-
MLINST5530-WGST	Warm Galvanized Steel	USD 1,885.00	-
Extras			
MLINSG	Plastic glides for Linear Steel Table and Bench - Black ***	USD 21.00	-
MLINSS	Adjustable Feet for Linear Steel Table & Bench	USD 34.00	-
MLINSM	Linear Steel Ground Mounting Kit	USD 142.00	-
MLINSC5530	Outdoor Cover for Linear Steel Table 140 x 75 CM / 55.1 x 29.5	USD 167.00	-

LINEAR STEEL TABLE / 220 X 90 CM / 86.6 X 35.5"

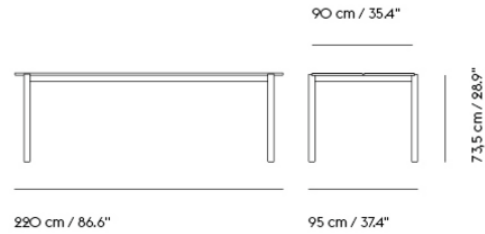

Shipper Colli	3
Gross Weight (kg)	73.1
Net Weight (kg)	62
Warranty Period	10 years

Pattern No.	Color	Contract Price	Lead Time
Ready-To-Ship US Warehouse			
MLINST8635-BLCK	Anthracite Black	USD 2,256.00	-
MLINST8635-BORG	Burnt Orange	USD 2,256.00	-
MLINST8635-DKGN	Dark Green	USD 2,256.00	-
MLINST8635-GREY	Grey	USD 2,256.00	-
MLINST8635-PABU	Pale Blue	USD 2,256.00	-
Extras			
MLINSG	Plastic glides for Linear Steel Table and Bench - Black ***	USD 21.00	-
MLINSS	Adjustable Feet for Linear Steel Table & Bench	USD 34.00	-
MLINSM	Linear Steel Ground Mounting Kit	USD 142.00	-
MODCV-BLCK	Outdoor Cover for 70/70 Outdoor Table and Linear Steel Table 220 x 90 CM / 86.6 x 35.5"	USD 299.00	-

LINEAR STEEL BENCH / 110 X 34 CM / 43.3 X 15.4"

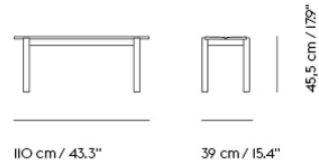

Shipper Colli	2
Gross Weight (kg)	30.132
Net Weight (kg)	22
Warranty Period	10 years

Pattern No.	Color	Contract Price	Lead Time
Ready-To-Ship US Warehouse			
MLINSB43-BLCK	Anthracite Black	USD 877.00	-
MLINSB43-BORG	Burnt Orange	USD 877.00	-
MLINSB43-DKGN	Dark Green	USD 877.00	-
MLINSB43-GREY	Grey	USD 877.00	-
MLINSB43-WHIT	Off-White ***	USD 877.00	-
MLINSB43-PABU	Pale Blue	USD 877.00	-
MLINSB43-WGST	Warm Galvanized Steel	USD 1,003.00	-
Extras			
MLINSG	Plastic glides for Linear Steel Table and Bench - Black ***	USD 21.00	-
MLINSS	Adjustable Feet for Linear Steel Table & Bench	USD 34.00	-
MLINSM	Linear Steel Ground Mounting Kit	USD 142.00	-
MLINSB43PD-DKGY	Bench Seat Pad - Twitell - Dark Grey	USD 198.00	-
MLINSB43PD-LTGY	Bench Seat Pad - Twitell - Light Grey	USD 198.00	-

LINEAR STEEL BENCH / 170 X 34 CM / 66.9 X 15.4"

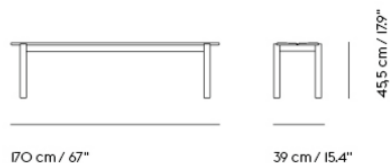

Shipper Colli	2
Gross Weight (kg)	27
Net Weight (kg)	25
Warranty Period	10 years

Pattern No.	Color	Contract Price	Lead Time
Ready-To-Ship US Warehouse			
MLINSB67-BLCK	Anthracite Black	USD 1,206.00	-
MLINSB67-BORG	Burnt Orange	USD 1,206.00	-
MLINSB67-DKGN	Dark Green	USD 1,206.00	-
MLINSB67-GREY	Grey	USD 1,206.00	-
MLINSB67-WHIT	Off-White ***	USD 1,206.00	-
MLINSB67-PABU	Pale Blue	USD 1,206.00	-
MLINSB67-WGST	Warm Galvanized Steel	USD 1,360.00	-
Extras			
MLINSG	Plastic glides for Linear Steel Table and Bench - Black ***	USD 21.00	-
MLINSS	Adjustable Feet for Linear Steel Table & Bench	USD 34.00	-
MLINSM	Linear Steel Ground Mounting Kit	USD 142.00	-
MLINSB67PD-DKGY	Bench Seat Pad - Twitell - Dark Grey	USD 272.00	-
MLINSB67PD-LTGY	Bench Seat Pad - Twitell - Light Grey	USD 272.00	-

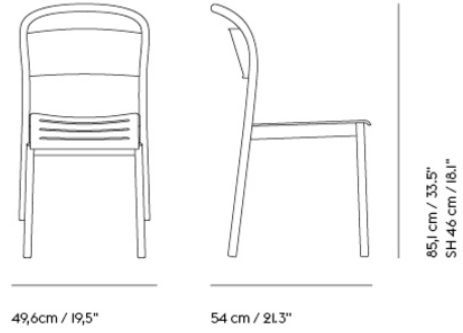

Shipper Colli	1
Gross Weight (kg)	11.45
Net Weight (kg)	8.05
Stacking Information	Linear Steel Side Chair stacks up to 5 chairs on the floor.
Warranty Period	5 years

Pattern No.	Color	Contract Price	Lead Time
Ready-To-Ship US Warehouse			
MLINSCHS-BLCK	Anthracite Black	USD 450.00	-
MLINSCHS-BORG	Burnt Orange	USD 450.00	-
MLINSCHS-DKGN	Dark Green	USD 450.00	-
MLINSCHS-GREY	Grey	USD 450.00	-
MLINSCHS-OWHIT	Off-White ***	USD 450.00	-
MLINSCHS-PABU	Pale Blue	USD 450.00	-
Extras			
MLINSCHRPD-DKGY	Chair Seat Pad - Twitell - Dark Grey	USD 100.00	-
MLINSCHRPD-LTGY	Chair Seat Pad - Twitell - Light Grey	USD 100.00	-

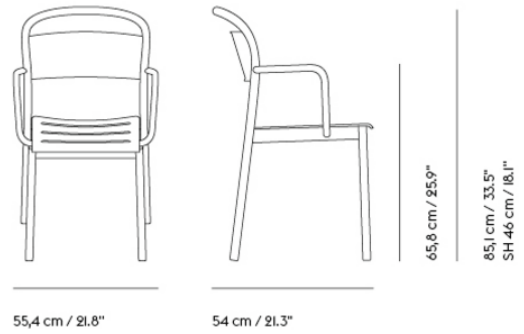

Shipper Colli	1
Gross Weight (kg)	12.4
Net Weight (kg)	8.2
Stacking Information	Linear Steel Armchair stacks up to 5 chairs on the floor.
Warranty Period	5 years

Pattern No.	Color	Contract Price	Lead Time
Ready-To-Ship US Warehouse			
MLINSCHA-BLCK	Anthracite Black	USD 488.00	-
MLINSCHA-BORG	Burnt Orange	USD 488.00	-
MLINSCHA-DKGN	Dark Green	USD 488.00	-
MLINSCHA-GREY	Grey	USD 488.00	-
MLINSCHA-PABU	Pale Blue	USD 488.00	-
Extras			
MLINSCHRPD-DKGY	Chair Seat Pad - Twitell - Dark Grey	USD 100.00	-
MLINSCHRPD-LTGY	Chair Seat Pad - Twitell - Light Grey	USD 100.00	-

LINEAR STEEL CAFÉ TABLE / 70 X 70 H: 73 CM / 27.6 X 27.6 H: 28.7"

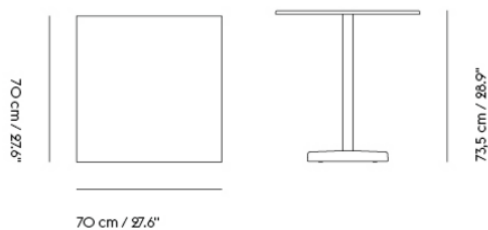

Shipper Colli	3
Gross Weight (kg)	28.704
Net Weight (kg)	26.2
Warranty Period	10 years

Pattern No.	Color	Contract Price	Lead Time
Ready-To-Ship US Warehouse			
MLINSCTR272728-BLCK	Anthracite Black	USD 933.00	-
MLINSCTR272728-BORG	Burnt Orange	USD 933.00	-
MLINSCTR272728-DKGN	Dark Green	USD 933.00	-
MLINSCTR272728-GREY	Grey	USD 933.00	-
MLINSCTR272728-PABU	Pale Blue	USD 933.00	-
Extras			
MLINSCTSCRK-BLCK	Screw Kit for Linear Steel Café and Coffee Table	USD 23.00	-

**LINEAR STEEL CAFÉ TABLE / 70 X 70 H:
95 CM / 27.6 X 27.6 H: 37.4"**

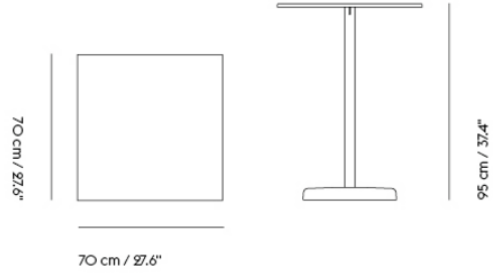

Shipper Colli 3
 Gross Weight (kg) 29.704
 Net Weight (kg) 27
 Warranty Period 10 years

Pattern No.	Color	Contract Price	Lead Time
Ready-To-Ship US Warehouse			
MLINSCTR272737-BLCK	Anthracite Black	USD 971.00	-
MLINSCTR272737-BORG	Burnt Orange	USD 971.00	-
MLINSCTR272737-DKGN	Dark Green	USD 971.00	-
MLINSCTR272737-GREY	Grey	USD 971.00	-
MLINSCTR272737-PABU	Pale Blue	USD 971.00	-
Extras			
MLINSCTSCRK-BLCK	Screw Kit for Linear Steel Café and Coffee Table	USD 23.00	-

**LINEAR STEEL CAFÉ TABLE / 70 X 70 H:
105 CM / 27.6 X 27.6 H: 41.3"**

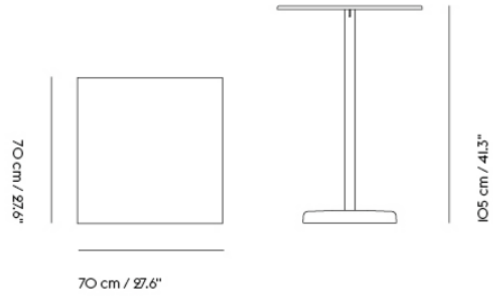

Shipper Colli 3
 Gross Weight (kg) 30.104
 Net Weight (kg) 27.3
 Warranty Period 10 years

Pattern No.	Color	Contract Price	Lead Time
Ready-To-Ship US Warehouse			
MLINSCTR272741-BLCK	Anthracite Black	USD 971.00	-
MLINSCTR272741-BORG	Burnt Orange	USD 971.00	-
MLINSCTR272741-DKGN	Dark Green	USD 971.00	-
MLINSCTR272741-GREY	Grey	USD 971.00	-
MLINSCTR272741-PABU	Pale Blue	USD 971.00	-
Extras			
MLINSCTSCRK-BLCK	Screw Kit for Linear Steel Café and Coffee Table	USD 23.00	-

LINEAR STEEL CAFÉ TABLE / Ø 70 H: 73 CM / 27.6 H: 28.7"

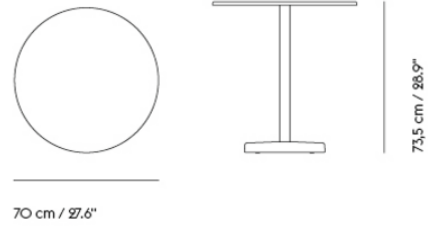

Shipper Colli	3
Gross Weight (kg)	26.704
Net Weight (kg)	24.2
Warranty Period	10 years

Pattern No.	Color	Contract Price	Lead Time
Ready-To-Ship US Warehouse			
MLINSCTO2728-BLCK	Anthracite Black	USD 933.00	-
MLINSCTO2728-BORG	Burnt Orange	USD 933.00	-
MLINSCTO2728-DKGN	Dark Green	USD 933.00	-
MLINSCTO2728-GREY	Grey	USD 933.00	-
MLINSCTO2728-PABU	Pale Blue	USD 933.00	-
Extras			
MLINSCTSCRK-BLCK	Screw Kit for Linear Steel Café and Coffee Table	USD 23.00	-

LINEAR STEEL CAFÉ TABLE / Ø 70 H: 95 CM / 27.6 H: 37.4"

227

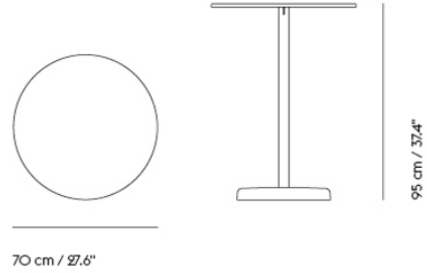

Shipper Colli 3
Gross Weight (kg) 27.704
Net Weight (kg) 25
Warranty Period 10 years

Pattern No.	Color	Contract Price	Lead Time
Ready-To-Ship US Warehouse			
MLINSCTO2737-BLCK	Anthracite Black	USD 971.00	-
MLINSCTO2737-BORG	Burnt Orange	USD 971.00	-
MLINSCTO2737-DKGN	Dark Green	USD 971.00	-
MLINSCTO2737-GREY	Grey	USD 971.00	-
MLINSCTO2737-PABU	Pale Blue	USD 971.00	-
Extras			
MLINSCTSCRK-BLCK	Screw Kit for Linear Steel Café and Coffee Table	USD 23.00	-

LINEAR STEEL CAFÉ TABLE / Ø 70 H: 105 CM / 27.6 H: 41.3"

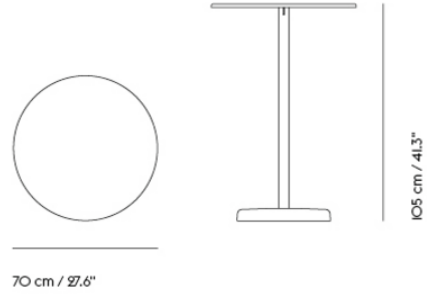

Shipper Colli 3
Gross Weight (kg) 28.104
Net Weight (kg) 25.3
Warranty Period 10 years

Pattern No.	Color	Contract Price	Lead Time
Ready-To-Ship US Warehouse			
MLINSCTO2741-BLCK	Anthracite Black	USD 971.00	-
MLINSCTO2741-BORG	Burnt Orange	USD 971.00	-
MLINSCTO2741-DKGN	Dark Green	USD 971.00	-
MLINSCTO2741-GREY	Grey	USD 971.00	-
MLINSCTO2741-PABU	Pale Blue	USD 971.00	-
Extras			
MLINSCTSCRK-BLCK	Screw Kit for Linear Steel Café and Coffee Table	USD 23.00	-

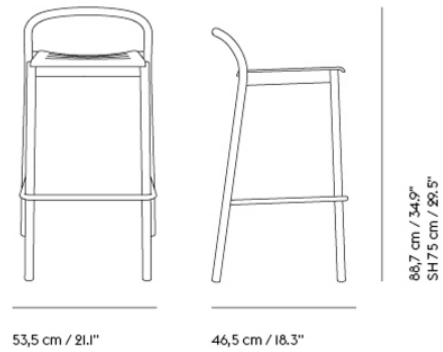

Shipper Colli	1
Gross Weight (kg)	12.7
Net Weight (kg)	9.5
Stacking Information	Linear Steel Bar Stool stacks up to 5 stools on the floor.
Warranty period	5 years

Pattern No.	Color	Contract Price	Lead Time
Ready-To-Ship US Warehouse			
MLINSSTB-BLCK	Anthracite Black	USD 530.00	-
MLINSSTB-BORG	Burnt Orange	USD 530.00	-
MLINSSTB-DKGN	Dark Green	USD 530.00	-
MLINSSTB-GREY	Grey	USD 530.00	-
MLINSSTB-PABU	Pale Blue	USD 530.00	-
Extras			
MLINSSTPD-DKGY	Bar/Counter Seat Pad - Twitell - Dark Grey	USD 89.00	-
MLINSSTPD-LTGY	Bar/Counter Seat Pad - Twitell - Light Grey	USD 89.00	-

LINEAR STEEL COUNTER STOOL 65 CM / 25.6"

230

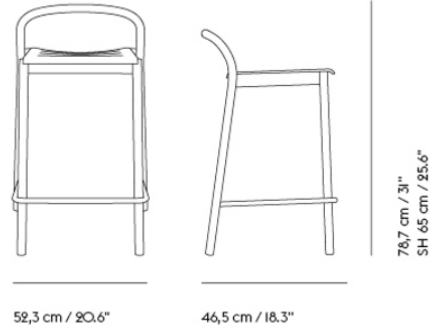

Shipper Colli	1
Gross Weight (kg)	12.1
Net Weight (kg)	8.9
Stacking Information	Linear Steel Counter Stool stacks up to 5 stools on the floor.
Warranty period	5 years

Pattern No.	Color	Contract Price	Lead Time
Ready-To-Ship US Warehouse			
MLINSSTC-BLCK	Anthracite Black	USD 530.00	-
MLINSSTC-BORG	Burnt Orange	USD 530.00	-
MLINSSTC-DKGN	Dark Green	USD 530.00	-
MLINSSTC-GREY	Grey	USD 530.00	-
MLINSSTC-PABU	Pale Blue	USD 530.00	-
Extras			
MLINSSTPD-DKGY	Bar/Counter Seat Pad - Twitell - Dark Grey	USD 89.00	-
MLINSSTPD-LTGY	Bar/Counter Seat Pad - Twitell - Light Grey	USD 89.00	-

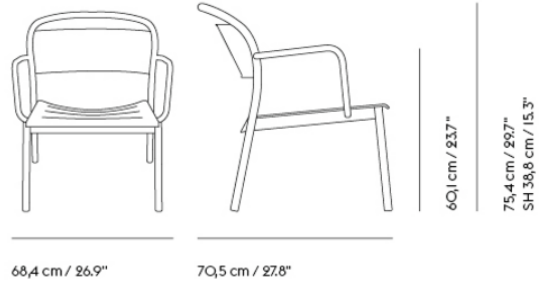

Shipper Colli	1
Gross Weight (kg)	16.35
Net Weight (kg)	13.2
Stacking Information	Linear Steel Lounge Chair stacks up to 4 chairs on the floor.
Warranty Period	10 years

Pattern No.	Color	Contract Price	Lead Time
Ready-To-Ship US Warehouse			
MLINSLC-BLCK	Anthracite Black	USD 929.00	-
MLINSLC-BORG	Burnt Orange	USD 929.00	-
MLINSLC-DKGN	Dark Green	USD 929.00	-
MLINSLC-GREY	Grey	USD 929.00	-
MLINSLC-PABU	Pale Blue	USD 929.00	-
Extras			
MLINSLCPD-DKGY	Lounge Chair Seat Pad - Twitell - Dark Grey	USD 121.00	-
MLINSLCPD-LTGY	Lounge Chair Seat Pad - Twitell - Light Grey	USD 121.00	-

LINEAR STEEL COFFEE TABLE / Ø 42 H: 47 CM / 16.5 H: 18.5"

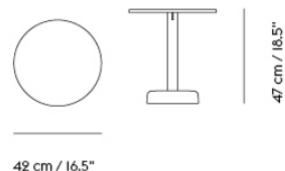

Shipper Colli	3
Gross Weight (kg)	10.6
Net Weight (kg)	7.4
Warranty period	10 years

Pattern No.	Color	Contract Price	Lead Time
Ready-To-Ship US Warehouse			
MLINSCFT01719-BLCK	Anthracite Black	USD 660.00	-
MLINSCFT01719-BORG	Burnt Orange	USD 660.00	-
MLINSCFT01719-DKGN	Dark Green	USD 660.00	-
MLINSCFT01719-GREY	Grey	USD 660.00	-
MLINSCFT01719-PABU	Pale Blue	USD 660.00	-
Extras			
MLINSCFTSCRK-BLCK	Screw Kit for Linear Steel Café and Coffee Table	USD 23.00	-

**LINEAR STEEL COFFEE TABLE / Ø 70 H:
40 CM / 27.5 H: 15.5"**

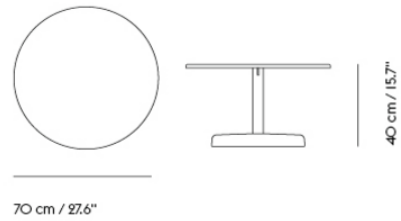

Shipper Colli 3
 Gross Weight (kg) 27.86
 Net Weight (kg) 23
 Warranty period 10 years

Pattern No.	Color	Contract Price	Lead Time
Ready-To-Ship US Warehouse			
MLINSCFT02716-BLCK	Anthracite Black	USD 797.00	-
MLINSCFT02716-BORG	Burnt Orange	USD 797.00	-
MLINSCFT02716-DKGN	Dark Green	USD 797.00	-
MLINSCFT02716-GREY	Grey	USD 797.00	-
MLINSCFT02716-PABU	Pale Blue	USD 797.00	-
Extras			
MLINSCFTSCRK-BLCK	Screw Kit for Linear Steel Café and Coffee Table	USD 23.00	-

LINEAR SYSTEM SERIES

FOR MORE INFORMATION,
EXPLORE BELOW

- ↗ Product Fact Sheet
- ↗ Images
- ↗ Architect Files
- ↗ Assembly Instructions
- ↗ Product Declaration
- ↗ Product Planner

The Linear System Series brings a new perspective to the evolving needs of the modern workspaces, hospitality settings and educational institutions through its configurable design across tables, lighting, screens and trays alongside its custom integrated power solution, allowing one to tailor the design to the exact needs of any space.

Option A — Choose between one of our predesigned table configurations and simply add your desired lamps and accessories.

Option B — Create your own configuration from scratch and add lamps and accessories from there.

Option A — Predesigned Table Configurations

STEP 1. TABLES

Select either the Linear System Table or one of two Linear System Table Configurations.

Note
Different finishes of tabletops cannot be mixed as they might vary in thickness.

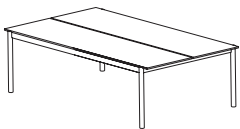
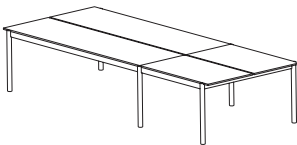
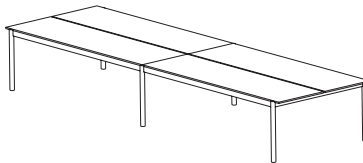
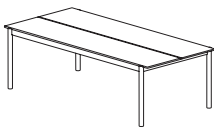
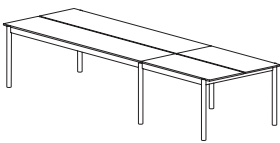
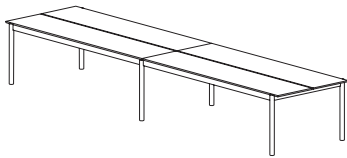
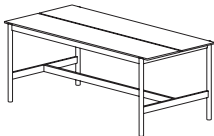
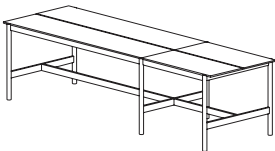
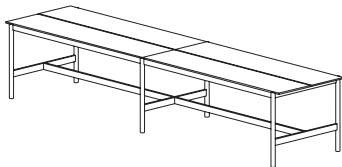
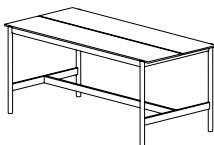
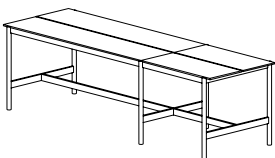
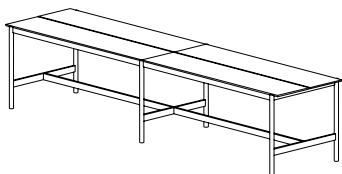
Table	Configuration 1	Configuration 2
<p>Linear System Table W142</p> <p>Height — 74 cm / 29.1" Table top width — 142 cm / 55.9" Total width — 146.9 cm / 57.8" No of Persons — 4-6</p>  <p>L 240 cm / 94.5"</p>	 <p>L 360 cm / 141.7"</p>	 <p>L 480 cm / 189"</p>
<p>Linear System Table W110</p> <p>Height — 74 cm / 29.1" Table top width — 110 cm / 43.3" Total width — 115 cm / 45.3" No of Persons — 4-6</p>  <p>L 240 cm / 94.5"</p>	 <p>L 360 cm / 141.7"</p>	 <p>L 480 cm / 189"</p>
<p>Linear System Table High H95</p> <p>Height — 95 cm / 37.4" Table top width — 110 cm / 43.3" Total width — 115 cm / 45.3" No of Persons — 4-6</p>  <p>L 240 cm / 94.5"</p>	 <p>L 360 cm / 141.7"</p>	 <p>L 480 cm / 189"</p>
<p>Linear System Table High H105</p> <p>Height — 105 cm / 41.4" Table top width — 110 cm / 43.3" Total width — 115 cm / 45.3" No of Persons — 4-6</p>  <p>L 240 cm / 94.5"</p>	 <p>L 360 cm / 141.7"</p>	 <p>L 480 cm / 189"</p>

OPTION A

1. TABLES / 2. ACCESSORIES / 3. LIGHTING / 4. TABLE POWER OUTLET / 5. INTEGRATED POWER / 6. CABLE TRAY / 7. CABLE GUIDE

STEP 2. ACCESSORIES

Trays

Add your desired number of Linear System Trays.

Note
Trays must be mounted at least 5 cm / 2" from the table edge.

Linear System Tray — Ø24 cm / 9.5"

Height — 15,6 cm / 6.2"
Diameter — 24 cm / 9.5"



Linear System Tray — Ø36 cm / 14.2"

Height — 9,6 cm / 3.8"
Diameter — 36 cm / 14.2"



Linear System Tray — 75 cm / 29.5"

Height — 15 cm / 5.9"
Width — 21 cm / 8.3"
Length — 75 cm / 29.5"

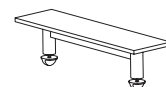

Screens

Add your desired number of Linear System Screens.

Note
We recommend that screens are mounted to the table. They must be placed at least 5 cm / 2" from the table edge.

Linear System Screen — 75 cm / 29.5"

Height — 35 cm / 13.8"
Width — 15 cm / 5.9"
Length — 75 cm / 29.5"

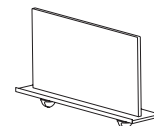

Linear System Screen — 125 cm / 49.2"

Height — 35 cm / 13.8"
Width — 15 cm / 5.9"
Length — 125 cm / 49.2"

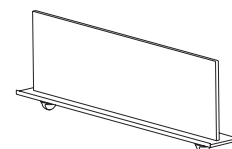

Linear System Screen — 178 cm / 70.1"

Height — 35 cm / 13.8"
Width — 15 cm / 5.9"
Length — 178 cm / 70.1"

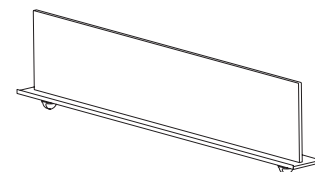

Note
Please note that only the Linear System Screen 125 cm / 49.2" can be mounted across the table.

Example

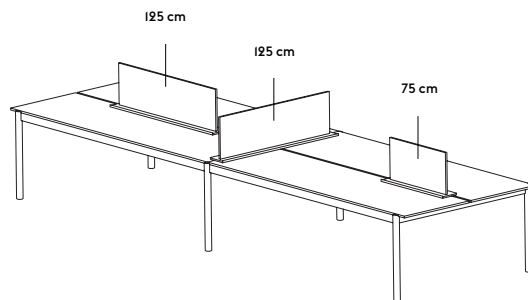

OPTION A
1. TABLES / 2. ACCESSORIES / 3. LIGHTING / 4. TABLE POWER OUTLET / 5. INTEGRATED POWER / 6. CABLE TRAY / 7. CABLE GUIDE

STEP 3. LIGHTING

Add your desired number of Linear Lamps.

Note
The Linear Table Lamp has one USB-C plug.

Linear Table Lamp

Height — 36,5 cm / 14.4"
Width — 23,2 cm / 9.1"
Depth — 16,5 cm / 6.5"



Note
Linear Mounted Lamp must be mounted at least 5 cm / 2" from the table edge.

Please be aware that the Linear Mounted Lamp and Table Power Outlet, both designed for the Linear System Series, have a special power solution with special plugs.

Linear Mounted Lamp — 23,2 cm / 9.1"

Height — 36,5 cm / 14.4"
Width — 23,2 cm / 9.1"
Depth — 10,7 cm / 4.2"

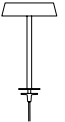

Linear Mounted Lamp — 209,2 cm / 82.4"

Height — 70,7 cm / 27.8"
Width — 209,2 cm / 82.4"
Depth — 10,7 cm / 4.2"



Linear Pendant Lamp — 87,2 cm / 34.3"

Height — 5,4 cm / 2.1"
Width — 87,2 cm / 34.3"
Depth — 10,7 cm / 4.2"



Linear Pendant Lamp — 169,2 cm / 66.6"

Height — 5,4 cm / 2.1"
Width — 169,2 cm / 66.6"
Depth — 10,7 cm / 4.2"



STEP 4. TABLE POWER OUTLETS

Specify your desired number of Table Power Outlets. Each Table Power Outlet has two outlets (one at each end) and one USB-A and USB-C plug to which standard plugs can be connected.

Note
Linear System Table Power Outlet must be mounted at least 5 cm / 2" from the table edge.

Linear System Table Power Outlet — EU, US

Height — 7 cm / 2.8"
Width — 7 cm / 2.8"
Length — 18 cm / 7.1"

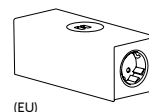

(EU)

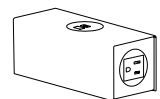

(US)

OPTION A

1. TABLES / 2. ACCESSORIES / 3. LIGHTING / 4. TABLE POWER OUTLET / 5. INTEGRATED POWER / 6. CABLE TRAY / 7. CABLE GUIDE

STEP 5. INTEGRATED POWER FOR MOUNTED LAMPS & TABLE POWER OUTLETS

If you'd like to add the Mounted Lamp(s) or Table Power Outlet(s), select the Table Power Kit for the Linear System Table or one of the three Power Configurations that match your selected Linear System Table Configuration.

Note
Each Distribution Block has four outlets to which up to four Linear Mounted Lamps or Linear System Table Power Outlets can be plugged in.

Distribution Block — 4-way

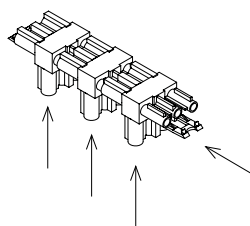

US cable
500 cm / 197" cable

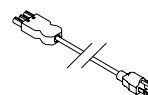

Linear System Table

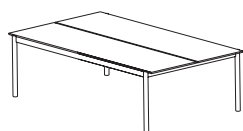

Linear System Power

Power Kit (1 pcs)
500 cm / 197" cable (US)
Distribution Block

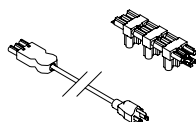

Linear System Table Configuration 1

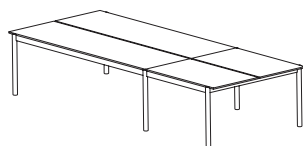

Linear System Power

Power Kit (1 pcs)
500 cm / 197" cable (US)
Distribution Block

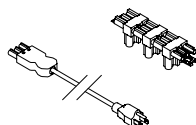

Linear System Table Configuration 2

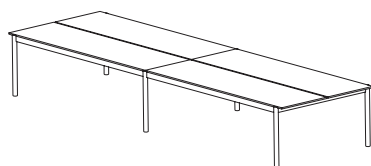

Linear System Power Configuration 2

Power Kit (1 pcs)
500 cm / 197" cable (US)
Distribution Block

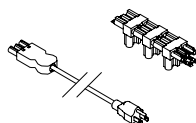

+

Power Kit (1 pcs)
500 cm / 197" cable (US)
Distribution Block

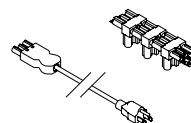

OPTION A

1. TABLES / 2. ACCESSORIES / 3. LIGHTING / 4. TABLE POWER OUTLET / 5. INTEGRATED POWER / 6. CABLE TRAY / 7. CABLE GUIDE

Note
The Integrated Power for Linear System Series has unique internal plugs to provide a slim and discreet look. This means that you cannot connect a standard plug to the power without using the Linear Table Power Outlet or changing the standard plug to a matching plug, being the Wieland GSTI8I3 plug.

The Linear Mounted Lamps must be connected to the integrated Power Kit.

Wieland GSTI8I3 plug

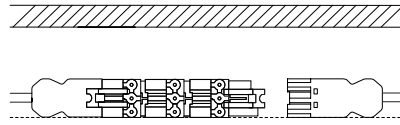

Standard plug (US)

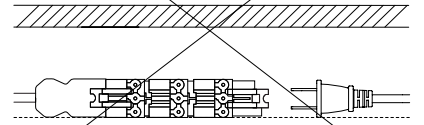

1. Connecting using the Wieland GSTI8I3 plug

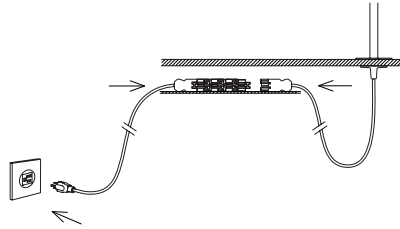

2. Connecting using a standard plug to the Linear Table Power Outlet

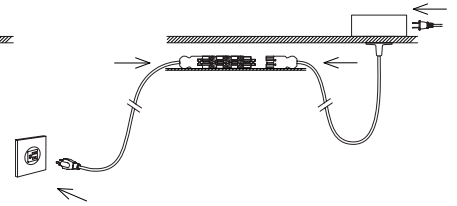

LINEAR TABLE LAMP ONLY

The Linear Table Lamp can either be connected to a standard wall plug or the Table Power Outlet.

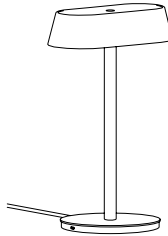

Standard plug

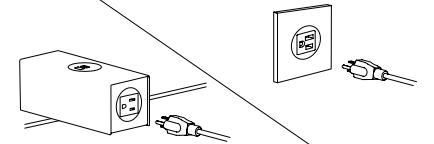

Linear Table Power Outlet

Alternatively, you can connect it to the integrated Power Kit by replacing the plug with a custom Wieland GSTI8I3 plug that is included with the lamp. Kindly refer to the Linear Table Lamp manual for instructions.

Integrated Table Power Kit (Wieland GSTI8I3 plug)

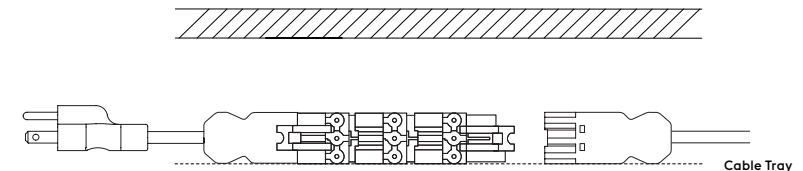

Cable Tray

OPTION A

1. TABLES / 2. ACCESSORIES / 3. LIGHTING / 4. TABLE POWER OUTLET / 5. INTEGRATED POWER / 6. CABLE TRAY / 7. CABLE GUIDE

STEP 6. CABLE TRAYS

We recommend using 1 Cable Tray for the End Module – 120 cm / 47.2" and up to 3 Cable Trays for the Linear Table, End Module – 240 cm / 94.2" and the Middle Module – 240 cm / 94.2".

Linear System Cable Tray

Height – 3 cm / 1.2"
 Width – 22 cm / 8.7"
 Depth – 60 cm / 23.7"

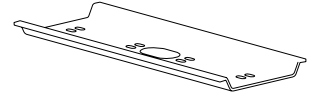

Example:

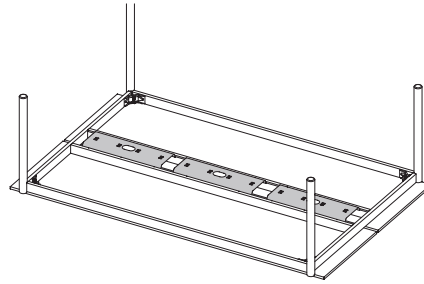

Linear System Table – 240 cm / 94.5"

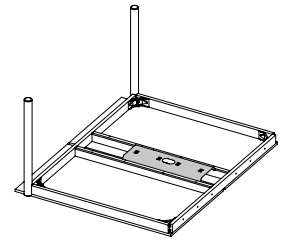

Linear System End Module – 120 cm / 47.2"

STEP 7. CABLE GUIDE

Cable guide also works for Base Table and fits a US cable.

Cable Guide

Height – 73 cm / 28.7"
 Height – 95 cm / 37.4"
 Height – 105 cm / 41.3"

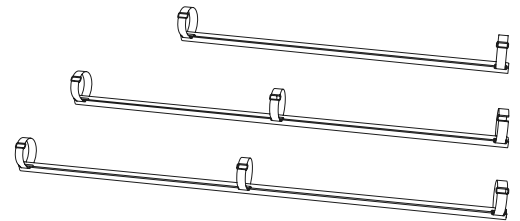

Example:

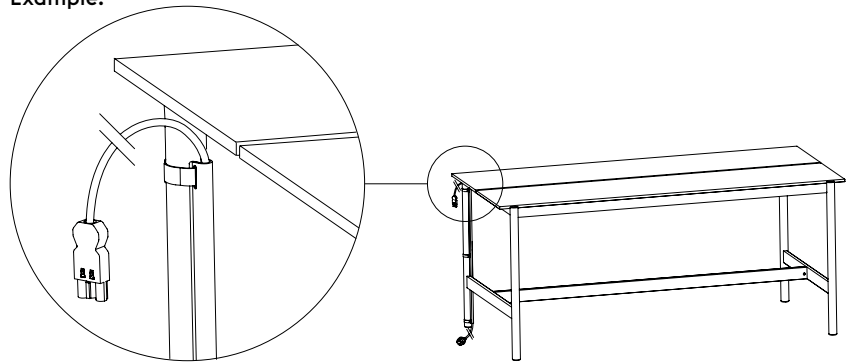

OPTION A

1. TABLES / 2. ACCESSORIES / 3. LIGHTING / 4. TABLE POWER OUTLET / 5. INTEGRATED POWER / 6. CABLE TRAY / 7. CABLE GUIDE

Option B — Create your own configuration

STEP 1. TABLES

A)

A configuration must always have End Modules in each end.

Start by defining the total length of your desired configuration, then select two table ends.

Note

Different finishes of tabletops cannot be mixed as they might vary in thickness.

Linear System End Module — 240 cm / 94.5"

Height — 74 cm / 29.1";
Width — 146,9 cm / 57.8"
Length — 240 cm / 94.5"
No of Persons — 4-6



Height — 74 cm / 29.1";
Width — 110 cm / 43.3";
Length — 240 cm / 94.5"
No of Persons — 4-6



Height - 95 cm / 37.4"
Width - 110 cm / 43.3"
Length - 240 cm / 94.5"
No of Persons - 4-6

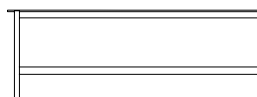

Height - 105 cm / 41.4"
Width - 110 cm / 43.3"
Length - 240 cm / 94.5"
No of Persons - 4-6

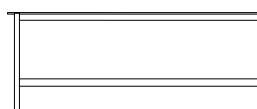

Linear System End Module — 120 cm / 47.2"

Height - 74 cm / 29.1"
Width - 110 cm / 43.3"
Length - 120 cm / 47.2"
No of Persons - 2

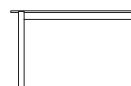

Height - 74 cm / 29.1"
Width - 146,9 cm / 57.8"
Length - 120 cm / 47.2"
No of Persons - 2

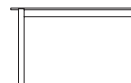

Height - 95 cm / 37.4"
Width - 110 cm / 43.3"
Length - 120 cm / 47.2"
No of Persons - 2

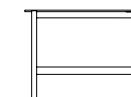

Height - 105 cm / 41.4"
Width - 110 cm / 43.3"
Length - 120 cm / 47.2"
No of Persons - 2

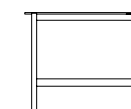

B)

Next, add the second, and final, End Module or your desired number of Middle Modules, only available in 240 cm / 94.5" length but in 2 different widths (110 cm / 43.3" and 142 cm / 55.9").

Note

Please note that it is not possible to connect more than two End Modules.

Linear System Middle Module — 240 cm / 94.5"

Width — 110 cm / 43.3";
142 cm / 55.9"
Length — 240 cm / 94.5"
No of Persons — 4-6



C)

Next, you must order 1 set of Connecting Legs every time two modules are connected.

Note

95cm / 37.4" and 105cm / 41.4" Connecting Legs can only be connected to 110cm / 43.3" width tabletops (not to 142 cm/55.9" width tabletops).

Linear System Connecting Legs

Height — 74 cm / 29.1"
95 cm / 37.4"
105 cm / 41.4"

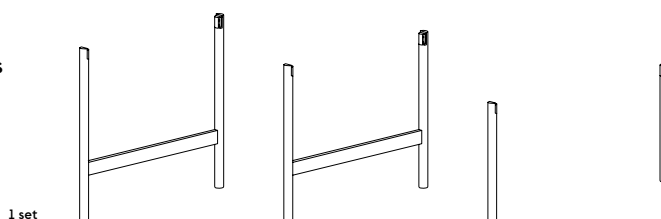

If you'd like a configuration of one End Module — 240 cm / 94.5" and one Middle Module — 240 cm / 94.5" and one End Module — 240 cm / 94.5", you must order two sets of Connecting Legs, as shown in the illustration.

Example

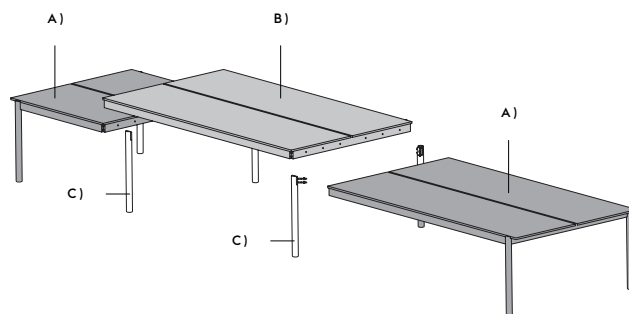

OPTION B

1. TABLES / 2. ACCESSORIES / 3. LIGHTING / 4. TABLE POWER OUTLET / 5. INTEGRATED POWER / 6. CABLE TRAY / 7. CABLE GUIDE

STEP 2. ACCESSORIES

Trays

Add your desired number of Linear System Trays.

Note
Trays must be mounted at least 5 cm / 2" from the table edge.

Linear System Tray — Ø24 cm / 9.5"

Height — 15,6 cm / 6.2"
Diameter — 24 cm / 9.5"



Linear System Tray — Ø36 cm / 14.2"

Height — 9,6 cm / 3.8"
Diameter — 36 cm / 14.2"



Linear System Tray — 75 cm / 29.5"

Height — 15 cm / 5.9"
Width — 21 cm / 8.3"
Length — 75 cm / 29.5"

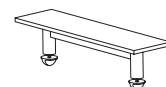

Screens

Add your desired number of Linear System Screens.

Note
We recommend that screens are mounted to the table. They must be placed at least 5 cm / 2" from the table edge.

Linear System Screen — 75 cm / 29.5"

Height — 35 cm / 13.8"
Width — 15 cm / 5.9"
Length — 75 cm / 29.5"

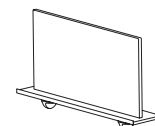

Linear System Screen — 125 cm / 49.2"

Height — 35 cm / 13.8"
Width — 15 cm / 5.9"
Length — 125 cm / 49.2"

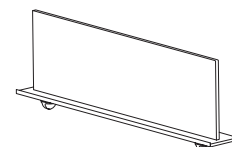

Linear System Screen — 178 cm / 70.1"

Height — 35 cm / 13.8"
Width — 15 cm / 5.9"
Length — 178 cm / 70.1"

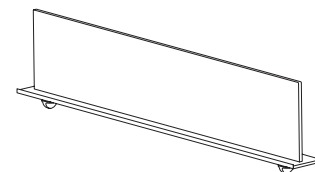

Note
Please note that only the Linear System Screen 125 cm / 49.2" can be mounted across the table.

Example

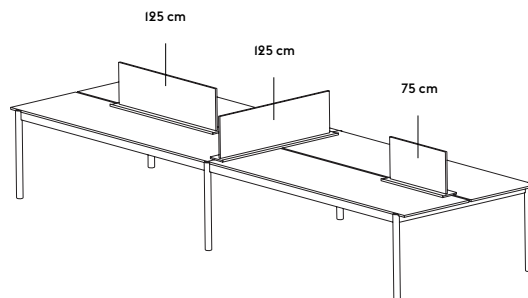

OPTION B
1. TABLES / 2. ACCESSORIES / 3. LIGHTING / 4. TABLE POWER OUTLET / 5. INTEGRATED POWER / 6. CABLE TRAY / 7. CABLE GUIDE

STEP 3. LIGHTING

Add your desired number of Linear Lamps.

Note
The Linear Table Lamp has one USB-C plug.

Linear Table Lamp

Height — 36,5 cm / 14.4"
Width — 23,2 cm / 9.1"
Depth — 16,5 cm / 6.5"



Note
Linear Mounted Lamp must be mounted at least 5 cm / 2" from the table edge.

Please be aware that the Linear Mounted Lamp and Table Power Outlet, both designed for the Linear System Series, have a special power solution with special plugs. See more on page 4.

Linear Mounted Lamp — 23,2 cm / 9.1"

Height — 36,5 cm / 14.4"
Width — 23,2 cm / 9.1"
Depth — 10,7 cm / 4.2"

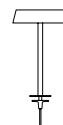

Linear Mounted Lamp — 209,2 cm / 82.4"

Height — 70,7 cm / 27.8"
Width — 209,2 cm / 82.4"
Depth — 10,7 cm / 4.2"



Linear Pendant Lamp — 87,2 cm / 34.3"

Height — 5,4 cm / 2.1"
Width — 87,2 cm / 34.3"
Depth — 10,7 cm / 4.2"



Linear Pendant Lamp — 169,2 cm / 66.6"

Height — 5,4 cm / 2.1"
Width — 169,2 cm / 66.6"
Depth — 10,7 cm / 4.2"



STEP 4. TABLE POWER OUTLETS

Specify your desired number of Table Power Outlets. Each Table Power Outlet has two outlets (one at each end) and one USB-A and USB-C plug to which standard plugs can be connected.

Note
Linear System Table Power Outlet must be mounted at least 5 cm / 2" from the table edge and requires a power kit for functionality.

Linear System Table Power Outlet — US

Height — 7 cm / 2.8"
Width — 7 cm / 2.8"
Length — 18 cm / 7.1"

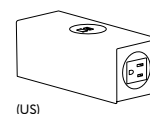

(US)

OPTION B

1. TABLES / 2. ACCESSORIES / 3. LIGHTING / 4. TABLE POWER OUTLET / 5. INTEGRATED POWER / 6. CABLE TRAY / 7. CABLE GUIDE

STEP 5. INTEGRATED POWER FOR MOUNTED LAMPS & TABLE POWER OUTLET

If you'd like to add the Mounted Lamp(s) and/or Table Power Outlets, select the Power Kit.

If you add a End Module or a Middle Module — 240 cm / 94.5" add a Power Kit for each table added.

If you add a End Module or a Middle Module — 240 cm / 94.5", select the 250 cm / 98" Power Extension Kit.

If you add a End Module — 120 cm / 47.2", select the 200 cm / 79" Power Extension kit.

Power Kit (1 pcs)

500 cm / 197" cable (US)
Distribution Block

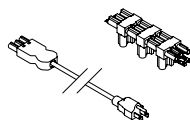

Example 1

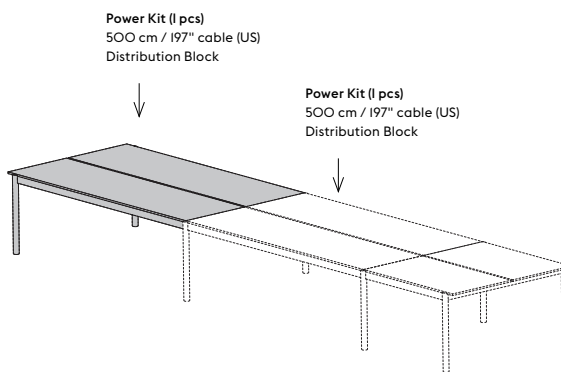

Example 2

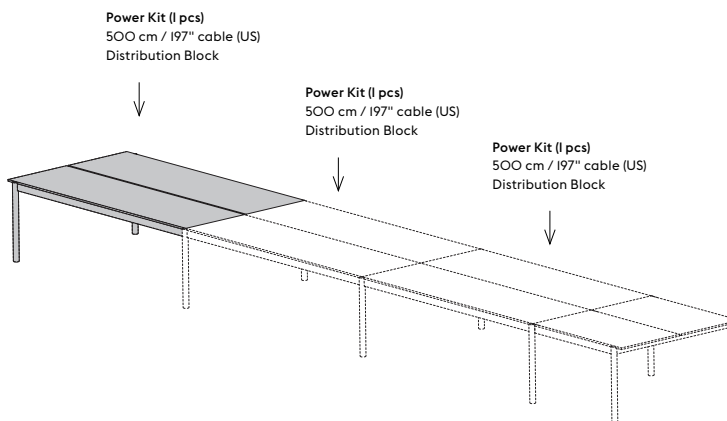

LINEAR TABLE LAMP ONLY

The Linear Table Lamp can either be connected to a standard wall plug or the Table Power Outlet.

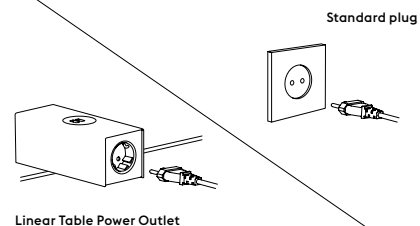
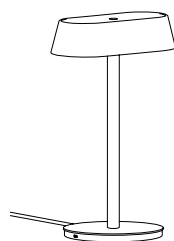

Alternatively, you can connect it to the integrated Table Power Kit by replacing the plug with a custom Wieland GST1813 plug that is included with the lamp. Kindly refer to the Linear Table Lamp manual for instructions.

Integrated Table Power Kit (Wieland GST1813 plug)

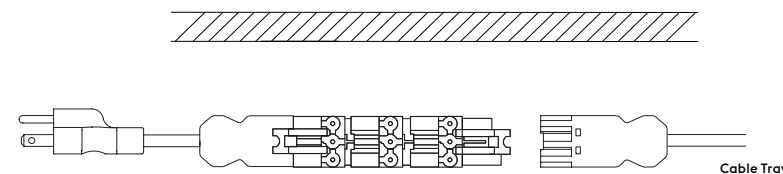

OPTION B

1. TABLES / 2. ACCESSORIES / 3. LIGHTING / 4. TABLE POWER OUTLET / 5. INTEGRATED POWER / 6. CABLE TRAY / 7. CABLE GUIDE

STEP 6. CABLE TRAYS

We recommend using 1 Cable Tray for the End Module – 120 cm / 47.2" and up to 3 Cable Trays for the Linear Table, End Module – 240 cm / 94.2" and the Middle Module – 240 cm / 94.2".

Linear System Cable Tray

Height – 3 cm / 1.2"
Width – 22 cm / 8.7"
Depth – 60 cm / 23.7"

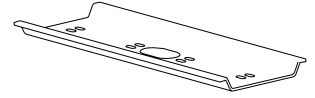

Example:

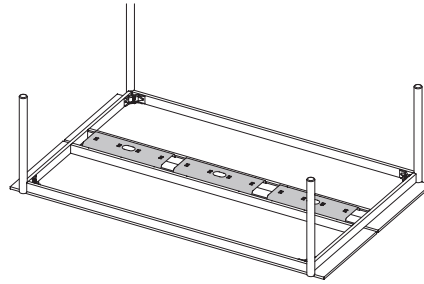

Linear System Table – 240 cm / 94.5"

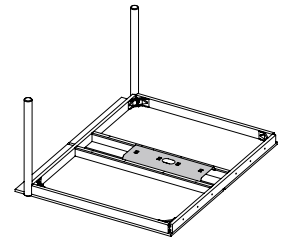

Linear System End Module – 120 cm / 47.2"

STEP 7. CABLE GUIDE

Cable guide also works for Base Table and fits a US cable.

Cable Guide

Height – 73 cm / 28.7"
Height – 95 cm / 37.4"
Height – 105 cm / 41.3"

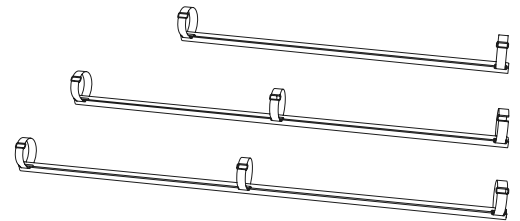

Example:

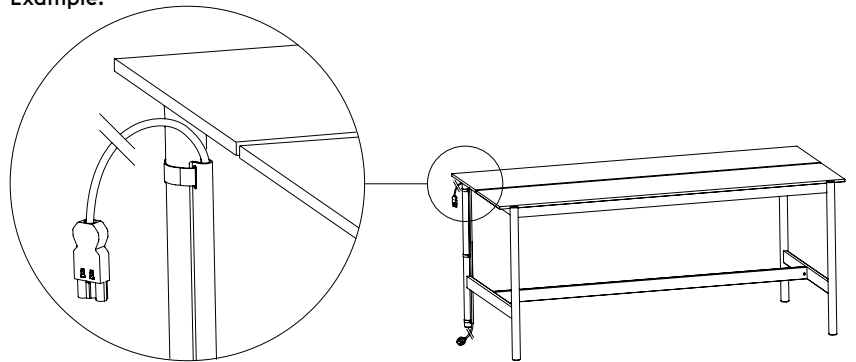

OPTION B

1. TABLES / 2. ACCESSORIES / 3. LIGHTING / 4. TABLE POWER OUTLET / 5. INTEGRATED POWER / 6. CABLE TRAY / 7. CABLE GUIDE

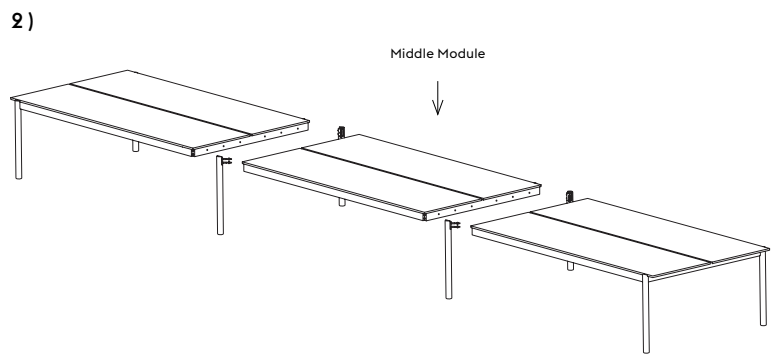
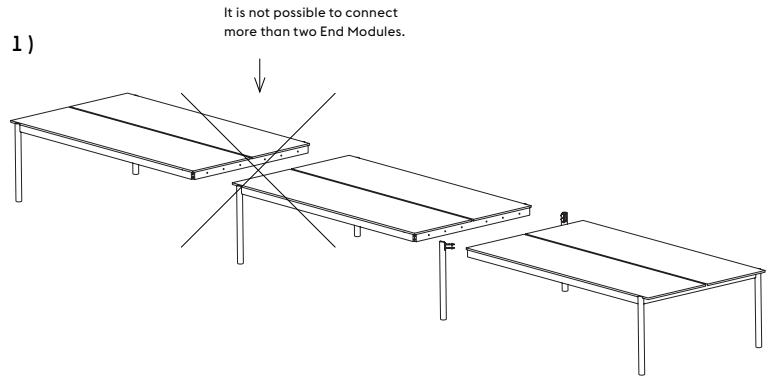

LINEAR SYSTEM TABLE / 110 X 240 CM / 43.3 X 94.5"

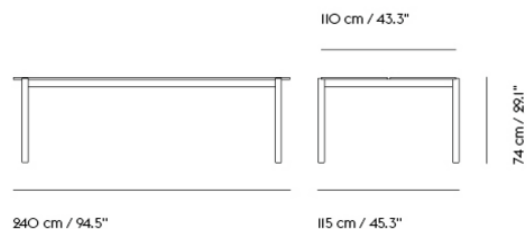
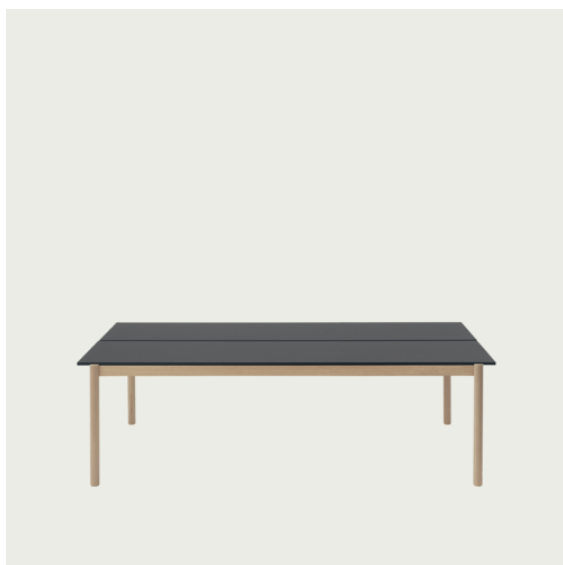

Shipper Colli	2
Gross Weight (kg)	69,057
Net Weight (kg)	30
Add-ons	Please visit planner.muuto.com/linear for recommended lighting, power and accessories
Warranty Period	5 years

Pattern No.	Color	Contract Price	Lead Time
Ready-To-Ship EU Warehouse			
MLINSYT4330TM-BLCK-BLCK	Black Nanolaminate/Black ABS/Black	USD 3,726.00	-
MLINSYT4330TM-BLCK-OAK	Black Nanolaminate/Black ABS/Oak	USD 3,726.00	-
MLINSYT4330TM-OAK-OAK	Oak Veneer/Oak	USD 3,201.00	-
Extras			
MLINSYSCG29-BLCK	Cable Guide - H: 73 cm / 28,7" - Black	USD 52.00	-
MLINSYSCG29-GREY	Cable Guide - H: 73 cm / 28,7" - Grey	USD 52.00	-

LINEAR SYSTEM TABLE / 142 X 240 CM / 55.9 X 94.5"

248

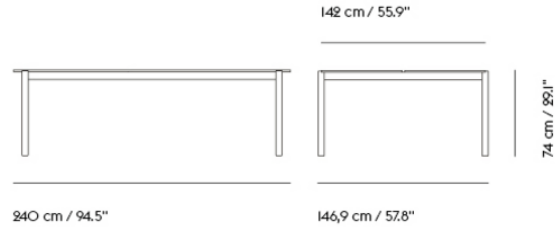

Shipper Colli	2
Gross Weight (kg)	69.057
Net Weight (kg)	61.8
Add-ons	Please visit planner.muuto.com/linear for recommended lighting, power and accessories
Warranty Period	5 years

Pattern No.	Color	Contract Price	Lead Time
Ready-To-Ship US Warehouse			
MLINSYTTM-WHIT-OAK	White Laminate/White ABS/Oak ***	USD 3,145.00	-
MLINSYTTM-BLCK-BLCK	Black Nanolaminate/Black ABS/Black	USD 3,880.00	-
MLINSYTTM-BLCK-OAK	Black Nanolaminate/Black ABS/Oak	USD 3,880.00	-
MLINSYTTM-OAK-OAK	Oak Veneer/Oak	USD 3,355.00	-
MLINSYTTM-BASH-BLCK	Black Lacquered Ash Veneer/Black	USD 3,355.00	-
Extras			
MLINSYSCG29-BLCK	Cable Guide - H: 73 cm / 28,7" - Black	USD 52.00	-
MLINSYSCG29-GREY	Cable Guide - H: 73 cm / 28,7" - Grey	USD 52.00	-

LINEAR SYSTEM TABLE / CONFIGURATION I - 110 X 360 CM / 43.3 X 141.7"



360 cm / 141.7"

110 cm / 43.3"

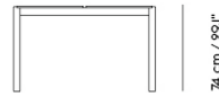

74 cm / 29.1"

115 cm / 45.3"

Shipper Colli	5
Gross Weight (kg)	101.177
Net Weight (kg)	30
Add-ons	Please visit planner.muuto.com/linear for recommended lighting, power and accessories
Warranty Period	5 years

Pattern No.	Color	Contract Price	Lead Time
Ready-To-Ship EU Warehouse			
MLINSYT4330C1-BLCK-BLCK	Black Nanolaminate/Black ABS/Black	USD 5,560.00	-
MLINSYT4330C1-BLCK-OAK	Black Nanolaminate/Black ABS/Oak	USD 5,560.00	-
MLINSYT4330C1-OAK-OAK	Oak Veneer/Oak	USD 5,035.00	-
Extras			
MLINSYSCG29-BLCK	Cable Guide - H: 73 cm / 28.7" - Black	USD 52.00	-
MLINSYSCG29-GREY	Cable Guide - H: 73 cm / 28.7" - Grey	USD 52.00	-

LINEAR SYSTEM TABLE / CONFIGURATION I - 142 X 360 CM / 55.9 X 141.7"



360 cm / 141.7"

142 cm / 55.9"



74 cm / 29.1"

146,9 cm / 57.8"

Shipper Colli	5
Gross Weight (kg)	109.886
Net Weight (kg)	93.895
Add-ons	Please visit planner.muuto.com/linear for recommended lighting, power and accessories
Warranty Period	5 years

Pattern No.	Color	Contract Price	Lead Time
Ready-To-Ship US Warehouse			
MLINSYTC1-WHIT-OAK	White Laminate/White ABS/Oak	USD 4,671.00	-
MLINSYTC1-BLCK-BLCK	Black Nanolaminate/Black ABS/Black	USD 5,875.00	-
MLINSYTC1-BLCK-OAK	Black Nanolaminate/Black ABS/Oak	USD 5,875.00	-
MLINSYTC1-OAK-OAK	Oak Veneer/Oak	USD 5,245.00	-
MLINSYTC1-BASH-BLCK	Black Lacquered Ash Veneer/Black	USD 5,245.00	-
Extras			
MLINSYSCG29-BLCK	Cable Guide - H: 73 cm / 28.7" - Black	USD 52.00	-
MLINSYSCG29-GREY	Cable Guide - H: 73 cm / 28.7" - Grey	USD 52.00	-

**LINEAR SYSTEM TABLE /
CONFIGURATION 2 - 110 X 480 CM / 43.3
X 189"**

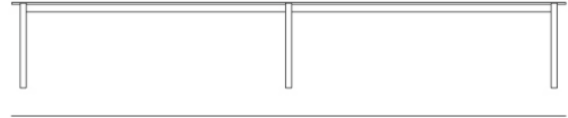

480 cm / 189"

110 cm / 43.3"



74 cm / 29.1"

115 cm / 45.3"

Shipper Colli	5
Gross Weight (kg)	129.612
Net Weight (kg)	60
Add-ons	Please visit planner.muuto.com/linear for recommended lighting, power and accessories
Warranty Period	5 years

Pattern No.	Color	Contract Price	Lead Time
Ready-To-Ship EU Warehouse			
MLINSYT4330C2-BLCK-BLCK	Black Nanolaminate/Black ABS/Black	USD 7,240.00	-
MLINSYT4330C2-BLCK-OAK	Black Nanolaminate/Black ABS/Oak	USD 7,240.00	-
MLINSYT4330C2-OAK-OAK	Oak Veneer/Oak	USD 6,295.00	-
Extras			
MLINSYSCG29-BLCK	Cable Guide - H: 73 cm / 28.7" - Black	USD 52.00	-
MLINSYSCG29-GREY	Cable Guide - H: 73 cm / 28.7" - Grey	USD 52.00	-

LINEAR SYSTEM TABLE / CONFIGURATION 2 - 142 X 480 CM / 55.9 X 189"

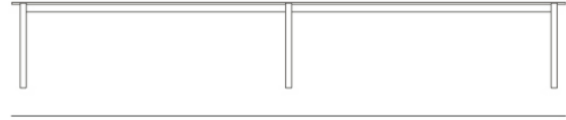

480 cm / 189"

142 cm / 55.9"



74 cm / 29.1"

146,9 cm / 57.8"

Shipper Colli	5
Gross Weight (kg)	141.512
Net Weight (kg)	122.82
Add-ons	Please visit planner.muuto.com/linear for recommended lighting, power and accessories
Warranty Period	5 years

Pattern No.	Color	Contract Price	Lead Time
Ready-To-Ship US Warehouse			
MLINSYTC2-WHIT-OAK	White Laminate/White ABS/Oak ***	USD 5,875.00	-
MLINSYTC2-BLCK-BLCK	Black Nanolaminate/Black ABS/Black	USD 7,555.00	-
MLINSYTC2-BLCK-OAK	Black Nanolaminate/Black ABS/Oak	USD 7,555.00	-
MLINSYTC2-OAK-OAK	Oak Veneer/Oak	USD 6,561.00	-
MLINSYTC2-BASH-BLCK	Black Lacquered Ash Veneer/Black	USD 6,561.00	-
Extras			
MLINSYSCG29-BLCK	Cable Guide - H: 73 cm / 28.7" - Black	USD 52.00	-
MLINSYSCG29-GREY	Cable Guide - H: 73 cm / 28.7" - Grey	USD 52.00	-

**LINEAR SYSTEM HIGH TABLE / 110 X 240
CM / 43.3 X 94.5" - H: 95 CM / 37.4"**

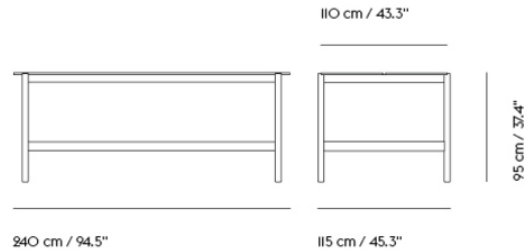

- Shipper Colli** 2
- Gross Weight (kg)** 69,057
- Net Weight (kg)** 30
- Add-ons** Please visit planner.muuto.com/linear for recommended lighting, power and accessories
- Warranty Period** 10 years

Pattern No.	Color	Contract Price	Lead Time
Ready-To-Ship EU Warehouse			
MLINSYT4337TM-BLCK-BLCK	Black Nanolaminate/Black ABS/Black	USD 5,140.00	-
MLINSYT4337TM-BLCK-OAK	Black Nanolaminate/Black ABS/Oak	USD 5,140.00	-
MLINSYT4337TM-OAK-OAK	Oak Veneer/Oak	USD 4,615.00	-
Extras			
MLINSYSCG37-BLCK	Cable Guide - H: 95 cm / 37,4" - Black	USD 72.00	-
MLINSYSCG37-GREY	Cable Guide - H: 95 cm / 37,4" - Grey	USD 72.00	-

LINEAR SYSTEM HIGH TABLE / 110 X 240 CM / 43.3 X 94.5" - H: 105 CM / 41.4"

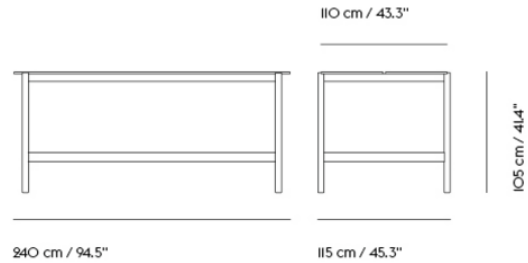

Shipper Colli	2
Gross Weight (kg)	69,057
Net Weight (kg)	30
Add-ons	Please visit planner.muuto.com/linear for recommended lighting, power and accessories
Warranty Period	10 years

Pattern No.	Color	Contract Price	Lead Time
Ready-To-Ship EU Warehouse			
MLINSYT4341TM-BLCK-BLCK	Black Nanolaminate/Black ABS/Black	USD 5,140.00	-
MLINSYT4341TM-BLCK-OAK	Black Nanolaminate/Black ABS/Oak	USD 5,140.00	-
MLINSYT4341TM-OAK-OAK	Oak Veneer/Oak	USD 4,615.00	-
Extras			
MLINSYSCG41-BLCK	Cable Guide - H: 105 cm / 41,3" - Black	USD 72.00	-
MLINSYSCG41-GREY	Cable Guide - H: 105 cm / 41,3" - Grey	USD 72.00	-

**LINEAR SYSTEM HIGH TABLE /
CONFIGURATION I - 110 X 360 CM / 43.3
X 141.7" - H: 95 CM / 37.4"**



360 cm / 141.7"

110 cm / 43.3"

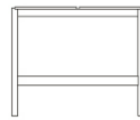

95 cm / 37.4"

115 cm / 45.3"

Shipper Colli	5
Gross Weight (kg)	101.177
Net Weight (kg)	30
Add-ons	Please visit planner.muuto.com/linear for recommended lighting, power and accessories
Warranty Period	10 years

Pattern No.	Color	Contract Price	Lead Time
Ready-To-Ship EU Warehouse			
MLINSYT4337C1-BLCK-BLCK	Black Nanolaminate/Black ABS/Black	USD 7,765.00	-
MLINSYT4337C1-BLCK-OAK	Black Nanolaminate/Black ABS/Oak	USD 7,765.00	-
MLINSYT4337C1-OAK-OAK	Oak Veneer/Oak	USD 7,191.00	-
Extras			
MLINSYSCG37-BLCK	Cable Guide - H: 95 cm / 37,4" - Black	USD 72.00	-
MLINSYSCG37-GREY	Cable Guide - H: 95 cm / 37,4" - Grey	USD 72.00	-

**LINEAR SYSTEM HIGH TABLE /
CONFIGURATION I - 110 X 360 CM / 43.3
X 141.7" - H: 105 CM / 41.4"**



360 cm / 141.7"

110 cm / 43.3"

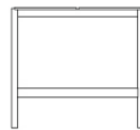

105 cm / 41.4"

115 cm / 45.3"

Shipper Colli	5
Gross Weight (kg)	101.177
Net Weight (kg)	30
Add-ons	Please visit planner.muuto.com/linear for recommended lighting, power and accessories
Warranty Period	10 years

Pattern No.	Color	Contract Price	Lead Time
Ready-To-Ship EU Warehouse			
MLINSYT4341C1-BLCK-BLCK	Black Nanolaminate/Black ABS/Black	USD 7,765.00	-
MLINSYT4341C1-BLCK-OAK	Black Nanolaminate/Black ABS/Oak	USD 7,765.00	-
MLINSYT4341C1-OAK-OAK	Oak Veneer/Oak	USD 7,191.00	-
Extras			
MLINSYSCG41-BLCK	Cable Guide - H: 105 cm / 41,3" - Black	USD 72.00	-
MLINSYSCG41-GREY	Cable Guide - H: 105 cm / 41,3" - Grey	USD 72.00	-

LINEAR SYSTEM HIGH TABLE / CONFIGURATION 2 - 110 X 480 CM / 43.3 X 189" - H: 95 CM / 37.4"



480 cm / 189"

110 cm / 43.3"



95 cm / 37.4"

115 cm / 45.3"

Shipper Colli	5
Gross Weight (kg)	129.612
Net Weight (kg)	60
Add-ons	Please visit planner.muuto.com/linear for recommended lighting, power and accessories
Warranty Period	10 years

Pattern No.	Color	Contract Price	Lead Time
Ready-To-Ship EU Warehouse			
MLINSYT4337C2-BLCK-BLCK	Black Nanolaminate/Black ABS/Black	USD 9,445.00	-
MLINSYT4337C2-BLCK-OAK	Black Nanolaminate/Black ABS/Oak	USD 9,445.00	-
MLINSYT4337C2-OAK-OAK	Oak Veneer/Oak	USD 8,500.00	-
Extras			
MLINSYSCG37-BLCK	Cable Guide - H: 95 cm / 37.4" - Black	USD 72.00	-
MLINSYSCG37-GREY	Cable Guide - H: 95 cm / 37.4" - Grey	USD 72.00	-

**LINEAR SYSTEM HIGH TABLE /
CONFIGURATION 2 - 110 X 480 CM / 43.3
X 189" - H: 105 CM / 41.4"**

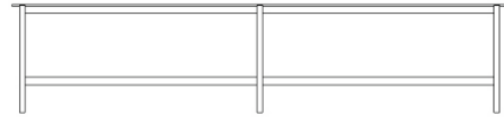

480 cm / 189"

110 cm / 43.3"

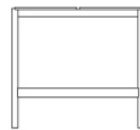

105 cm / 41.4"

115 cm / 45.3"

Shipper Colli	5
Gross Weight (kg)	129.612
Net Weight (kg)	60
Add-ons	Please visit planner.muuto.com/linear for recommended lighting, power and accessories
Warranty Period	10 years

Pattern No.	Color	Contract Price	Lead Time
Ready-To-Ship EU Warehouse			
MLINSYT4341C2-BLCK-BLCK	Black Nanolaminate/Black ABS/Black	USD 9,445.00	-
MLINSYT4341C2-BLCK-OAK	Black Nanolaminate/Black ABS/Oak	USD 9,445.00	-
MLINSYT4341C2-OAK-OAK	Oak Veneer/Oak	USD 8,500.00	-
Extras			
MLINSYSCG41-BLCK	Cable Guide - H: 105 cm / 41,3" - Black	USD 72.00	-
MLINSYSCG41-GREY	Cable Guide - H: 105 cm / 41,3" - Grey	USD 72.00	-

LINEAR SYSTEM MIDDLE MODULE / TABLE - 110 X 240 CM / 43.3 X 94.5"

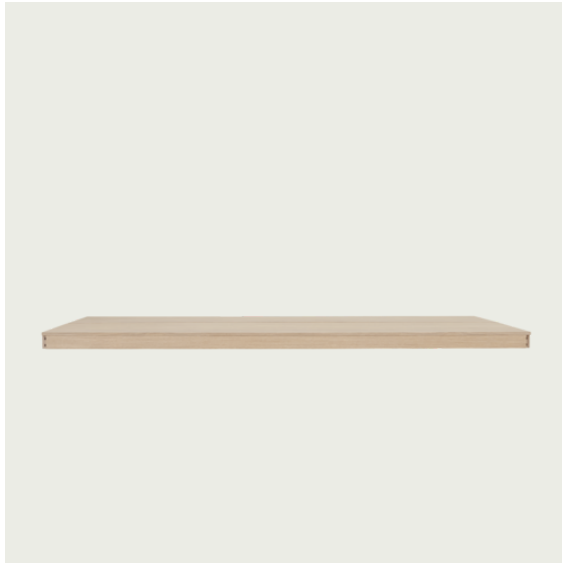

240 cm / 94.5"

Shipper Colli	2
Gross Weight (kg)	63.15
Net Weight (kg)	30
Add-ons	Please visit planner.muuto.com/linear for recommended lighting, power and accessories
Warranty Period	5 years

Pattern No.	Color	Contract Price	Lead Time
Ready-To-Ship EU Warehouse			
MLINSYT43DNMM-BLCK-BLCK	Black Nanolaminate/Black ABS/Black	USD 3,306.00	-
MLINSYT43DNMM-BLCK-OAK	Black Nanolaminate/Black ABS/Oak	USD 3,306.00	-
MLINSYT43DNMM-OAK-OAK	Oak Veneer/Oak	USD 2,781.00	-

LINEAR SYSTEM MIDDLE MODULE / TABLE - 142 X 240 CM / 55.9 X 94.5"



240 cm / 94.5"

Shipper Colli	2
Gross Weight (kg)	63.15
Net Weight (kg)	57.65
Add-ons	Please visit planner.muuto.com/linear for recommended lighting, power and accessories
Warranty Period	5 years

Pattern No.	Color	Contract Price	Lead Time
Ready-To-Ship US Warehouse			
MLINSYTMM-WHIT-OAK	White Laminate/White ABS/Oak ***	USD 2,781.00	-
MLINSYTMM-BLCK-BLCK	Black Nanolaminate/Black ABS/Black	USD 3,516.00	-
MLINSYTMM-BLCK-OAK	Black Nanolaminate/Black ABS/Oak	USD 3,516.00	-
MLINSYTMM-OAK-OAK	Oak Veneer/Oak	USD 2,886.00	-
MLINSYTMM-BASH-BLCK	Black Lacquered Ash Veneer/Black	USD 2,886.00	-

LINEAR SYSTEM MIDDLE MODULE / HIGH TABLE - 110 X 240 CM / 43.3 X 94.5"

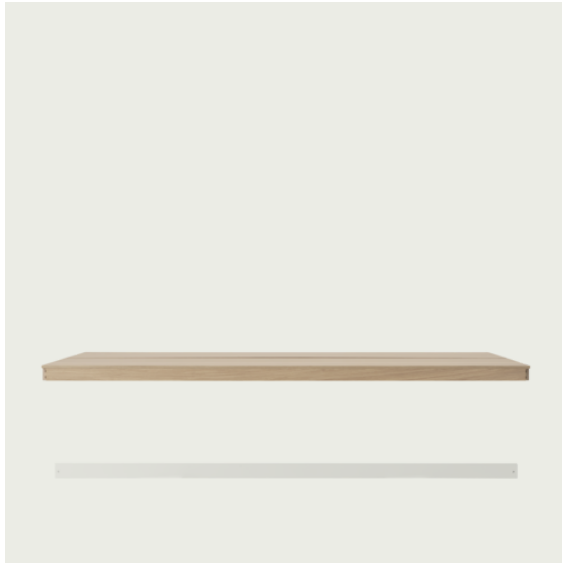

Shipper Colli 2
Gross Weight (kg) 63.15
Net Weight (kg) 30
Add-ons Please visit planner.muuto.com/linear for recommended lighting, power and accessories
Warranty Period 10 years

Pattern No.	Color	Contract Price	Lead Time
Ready-To-Ship EU Warehouse			
MLINSYT43HTMM-BLCK-BLCK	Black Nanolaminate/Black ABS/Black	USD 3,411.00	-
MLINSYT43HTMM-BLCK-OAK	Black Nanolaminate/Black ABS/Oak	USD 3,411.00	-
MLINSYT43HTMM-OAK-OAK	Oak Veneer/Oak	USD 2,935.00	-

LINEAR SYSTEM END MODULE / TABLE - 142 X 120 CM / 55.9 X 47.2"

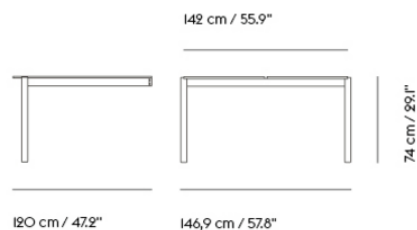
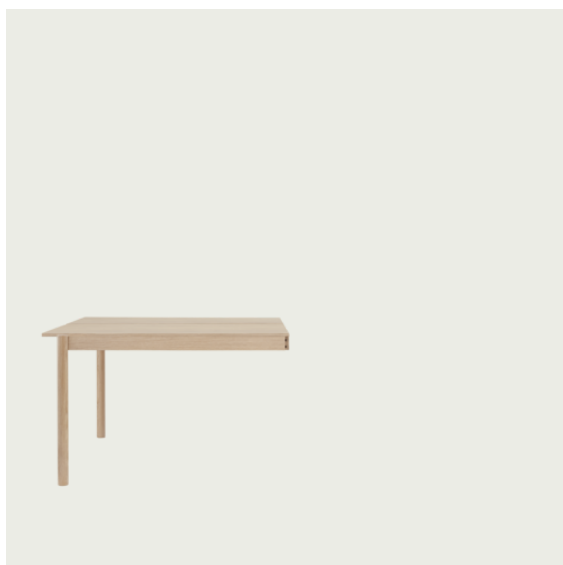

Shipper Colli	2
Gross Weight (kg)	36.371
Net Weight (kg)	31.475
Add-ons	Please visit planner.muuto.com/linear for recommended lighting, power and accessories
Warranty Period	5 years

Pattern No.	Color	Contract Price	Lead Time
Ready-To-Ship US Warehouse			
MLINSYTEM5647-WHIT-OAK	White Laminate/White ABS/Oak ***	USD 1,836.00	-
MLINSYTEM5647-BLCK-BLCK	Black Nanolaminate/Black ABS/Black	USD 2,361.00	-
MLINSYTEM5647-BLCK-OAK	Black Nanolaminate/Black ABS/Oak	USD 2,361.00	-
MLINSYTEM5647-OAK-OAK	Oak Veneer/Oak	USD 1,836.00	-
MLINSYTEM5647-BASH-BLCK	Black Lacquered Ash Veneer/Black	USD 1,836.00	-

LINEAR SYSTEM END MODULE / TABLE - 142 X 240 CM / 55.9 X 94.5"

263

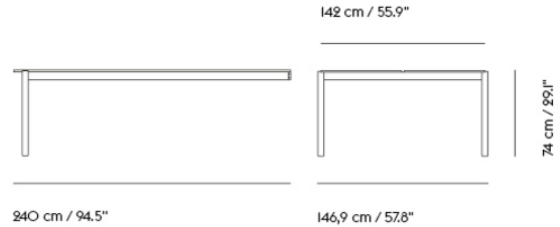

Shipper Colli	2
Gross Weight (kg)	64.806
Net Weight (kg)	59.5
Add-ons	Please visit planner.muuto.com/linear for recommended lighting, power and accessories
Warranty Period	5 years

Pattern No.	Color	Contract Price	Lead Time
Ready-To-Ship US Warehouse			
MLINSYTEM5695-WHIT-OAK	White Laminate/White ABS/Oak ***	USD 3,355.00	-
MLINSYTEM5695-BLCK-BLCK	Black Nanolaminate/Black ABS/Black	USD 3,831.00	-
MLINSYTEM5695-BLCK-OAK	Black Nanolaminate/Black ABS/Oak	USD 3,831.00	-
MLINSYTEM5695-OAK-OAK	Oak Veneer/Oak	USD 3,355.00	-
MLINSYTEM5695-BASH-BLCK	Black Lacquered Ash Veneer/Black	USD 3,355.00	-

**LINEAR SYSTEM END MODULE / TABLE -
110 X 120 H: 74 CM / 43.3 X 47.2 H: 29.1"**

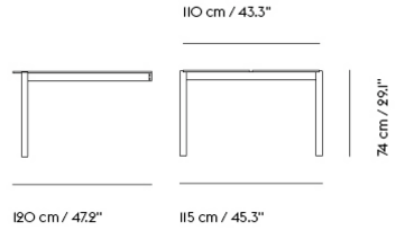
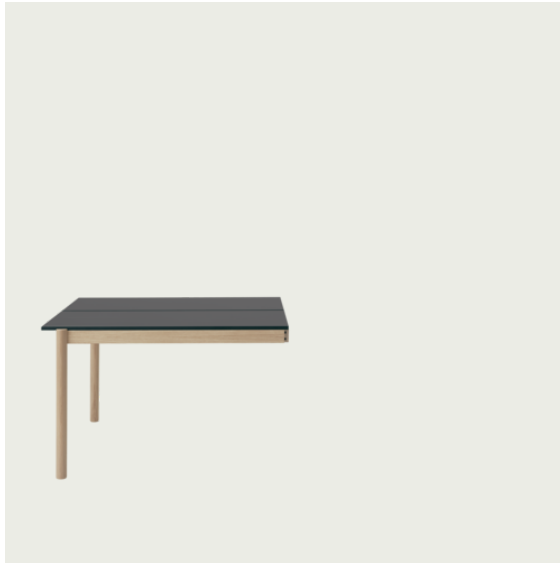

Shipper Colli	2
Gross Weight (kg)	36.371
Net Weight (kg)	15.5
Add-ons	Please visit planner.muuto.com/linear for recommended lighting, power and accessories
Warranty Period	5 years

Pattern No.	Color	Contract Price	Lead Time
Ready-To-Ship EU Warehouse			
MLINSYT4330EM5647-BLCK-BLCK	Black Nanolaminate/Black ABS/Black	USD 2,305.00	-
MLINSYT4330EM5647-BLCK-OAK	Black Nanolaminate/Black ABS/Oak	USD 2,305.00	-
MLINSYT4330EM5647-OAK-OAK	Oak Veneer/Oak	USD 1,731.00	-

**LINEAR SYSTEM END MODULE / TABLE -
110 X 240 H: 74 CM / 43.3 X 94.5 H: 29.1"**

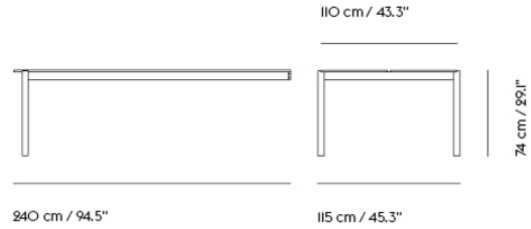

Shipper Colli	2
Gross Weight (kg)	64.806
Net Weight (kg)	30
Add-ons	Please visit planner.muuto.com/linear for recommended lighting, power and accessories
Warranty Period	5 years

Pattern No.	Color	Contract Price	Lead Time
Ready-To-Ship EU Warehouse			
MLINSYT4330EM5695-BLCK-BLCK	Black Nanolaminate/Black ABS/Black	USD 3,621.00	-
MLINSYT4330EM5695-BLCK-OAK	Black Nanolaminate/Black ABS/Oak	USD 3,621.00	-
MLINSYT4330EM5695-OAK-OAK	Oak Veneer/Oak	USD 3,201.00	-

LINEAR SYSTEM END MODULE / HIGH TABLE - 110 X 120 H: 95 CM / 43.3 X 47.2 H: 37.4"

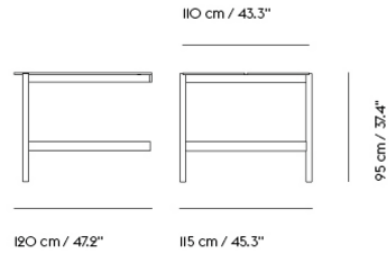

Shipper Colli	2
Gross Weight (kg)	36.371
Net Weight (kg)	15.5
Add-ons	Please visit planner.muuto.com/linear for recommended lighting, power and accessories
Warranty Period	10 years

Pattern No.	Color	Contract Price	Lead Time
Ready-To-Ship EU Warehouse			
MLINSYT4337EM5647-BLCK-BLCK	Black Nanolaminate/Black ABS/Black	USD 3,040.00	-
MLINSYT4337EM5647-BLCK-OAK	Black Nanolaminate/Black ABS/Oak	USD 3,040.00	-
MLINSYT4337EM5647-OAK-OAK	Oak Veneer/Oak	USD 2,410.00	-
Extras			
MLINSYSCG37-BLCK	Cable Guide - H: 95 cm / 37,4" - Black	USD 72.00	-
MLINSYSCG37-GREY	Cable Guide - H: 95 cm / 37,4" - Grey	USD 72.00	-

LINEAR SYSTEM END MODULE / HIGH TABLE - 110 X 240 H: 95 CM / 43.3 X 94.5 H: 37.4"

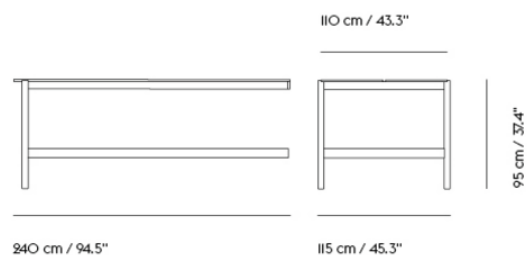

Shipper Colli	2
Gross Weight (kg)	64.806
Net Weight (kg)	30
Add-ons	Please visit planner.muuto.com/linear for recommended lighting, power and accessories
Warranty Period	10 years

Pattern No.	Color	Contract Price	Lead Time
Ready-To-Ship EU Warehouse			
MLINSYT4337EM5695-BLCK-BLCK	Black Nanolaminate/Black ABS/Black	USD 4,251.00	-
MLINSYT4337EM5695-BLCK-OAK	Black Nanolaminate/Black ABS/Oak	USD 4,251.00	-
MLINSYT4337EM5695-OAK-OAK	Oak Veneer/Oak	USD 3,880.00	-
Extras			
MLINSYSCG37-BLCK	Cable Guide - H: 95 cm / 37,4" - Black	USD 72.00	-
MLINSYSCG37-GREY	Cable Guide - H: 95 cm / 37,4" - Grey	USD 72.00	-

**LINEAR SYSTEM END MODULE / HIGH
TABLE - 110 X 120 H: 105 CM / 43.3 X 47.2
H: 41.4"**

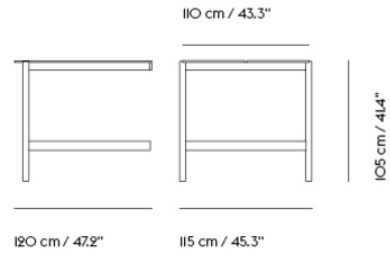

Shipper Colli	2
Gross Weight (kg)	36.371
Net Weight (kg)	15.5
Add-ons	Please visit planner.muuto.com/linear for recommended lighting, power and accessories
Warranty Period	10 years

Pattern No.	Color	Contract Price	Lead Time
Ready-To-Ship EU Warehouse			
MLINSYT4341EM5647-BLCK-BLCK	Black Nanolaminate/Black ABS/Black	USD 3,040.00	-
MLINSYT4341EM5647-BLCK-OAK	Black Nanolaminate/Black ABS/Oak	USD 3,040.00	-
MLINSYT4341EM5647-OAK-OAK	Oak Veneer/Oak	USD 2,410.00	-
Extras			
MLINSYSCG41-BLCK	Cable Guide - H: 105 cm / 41,3" - Black	USD 72.00	-
MLINSYSCG41-GREY	Cable Guide - H: 105 cm / 41,3" - Grey	USD 72.00	-

LINEAR SYSTEM END MODULE / HIGH TABLE - 110 X 240 H: 105 CM / 43.3 X 94.5 H: 41.4"

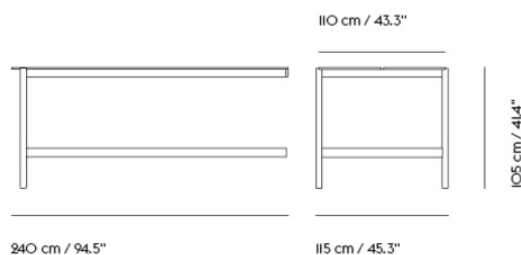
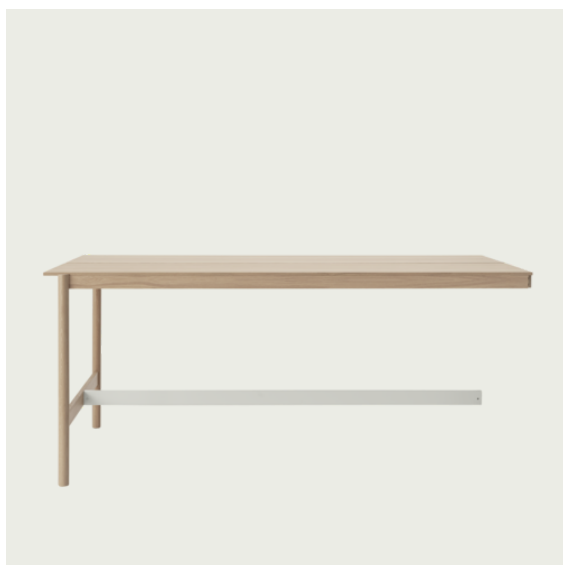

Shipper Colli	2
Gross Weight (kg)	64.806
Net Weight (kg)	30
Add-ons	Please visit planner.muuto.com/linear for recommended lighting, power and accessories
Warranty Period	10 years

Pattern No.	Color	Contract Price	Lead Time
Ready-To-Ship EU Warehouse			
MLINSYT4341EM5695-BLCK-BLCK	Black Nanolaminate/Black ABS/Black	USD 4,251.00	-
MLINSYT4341EM5695-BLCK-OAK	Black Nanolaminate/Black ABS/Oak	USD 4,251.00	-
MLINSYT4341EM5695-OAK-OAK	Oak Veneer/Oak	USD 3,880.00	-
Extras			
MLINSYSCG41-BLCK	Cable Guide - H: 105 cm / 41,3" - Black	USD 72.00	-
MLINSYSCG41-GREY	Cable Guide - H: 105 cm / 41,3" - Grey	USD 72.00	-

**LINEAR SYSTEM CONNECTING LEGS /
TABLE - H: 74 CM**



- Shipper Colli 1
- Gross Weight (kg) 3.1
- Net Weight (kg) 2.3
- Add-ons Please visit planner.muuto.com/linear for recommended lighting, power and accessories
- Warranty Period 5 years

Pattern No.	Color	Contract Price	Lead Time
Ready-To-Ship US Warehouse			
MLINSYTCL-BLCK	Black	USD 310.00	-
MLINSYTCL-OAK	Oak	USD 310.00	-
Ready-To-Ship EU Warehouse			
MLINSYT4330CL-BLCK-BLCK	Black - H: 74 cm / 29.1"	USD 257.00	-
MLINSYT4330CL-OAK-OAK	Oak - H: 74 cm / 29.1"	USD 257.00	-

LINEAR SYSTEM CONNECTING LEGS / HIGH TABLE - H: 95 CM

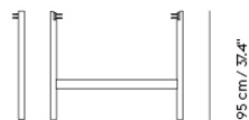

Shipper Colli	1
Gross Weight (kg)	7.1
Net Weight (kg)	6.2
Add-ons	Please visit planner.muuto.com/linear for recommended lighting, power and accessories
Warranty Period	10 years

Pattern No.	Color	Contract Price	Lead Time
Ready-To-Ship EU Warehouse			
MLINSYT4337CL-OAK-OAK	Oak - H: 95 cm / 37.4"	USD 394.00	-
MLINSYT4337CL-BLCK-BLCK	Black - H: 95 cm / 37.4"	USD 404.00	-
Extras			
MLINSYSCG37-BLCK	Cable Guide - H: 95 cm / 37.4" - Black	USD 72.00	-
MLINSYSCG37-GREY	Cable Guide - H: 95 cm / 37.4" - Grey	USD 72.00	-

LINEAR SYSTEM CONNECTING LEGS / HIGH TABLE - H: 105 CM

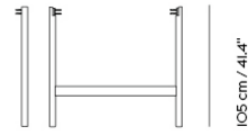

Shipper Colli	1
Gross Weight (kg)	5.6
Net Weight (kg)	4.7
Add-ons	Please visit planner.muuto.com/linear for recommended lighting, power and accessories
Warranty Period	10 years

Pattern No.	Color	Contract Price	Lead Time
Ready-To-Ship EU Warehouse			
MLINSYT4341CL-OAK-OAK	Oak - H: 105 cm / H: 41.3"	USD 404.00	-
MLINSYT4341CL-BLCK-BLCK	Black - H: 105 cm / H: 41.3"	USD 415.00	-
Extras			
MLINSYSCG41-BLCK	Cable Guide - H: 105 cm / 41,3" - Black	USD 72.00	-
MLINSYSCG41-GREY	Cable Guide - H: 105 cm / 41,3" - Grey	USD 72.00	-

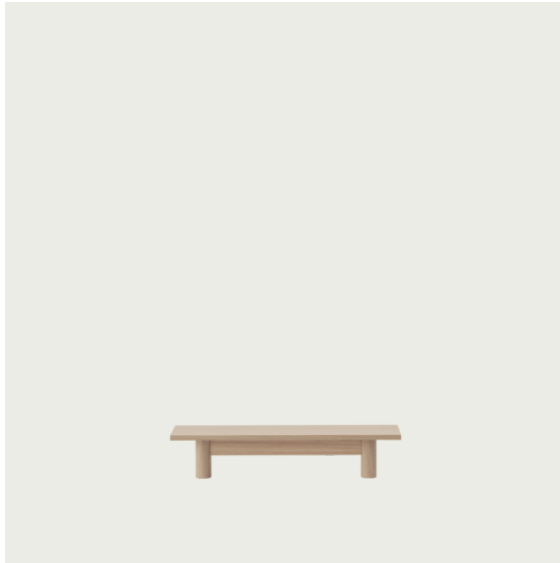

75 cm / 29.5"

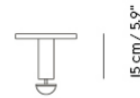

21 cm / 8.3"

Shipper Colli	1
Gross Weight (kg)	4.8
Net Weight (kg)	3.5
Add-ons	Please visit planner.muuto.com/linear for recommended lighting, power and accessories
Warranty Period	5 years

Pattern No.	Color	Contract Price	Lead Time
Ready-To-Ship EU Warehouse			
MLINSYTTR30-BLCK	Black	USD 257.00	-
MLINSYTTR30-OAK	Oak	USD 257.00	-



170 cm / 66.9"



15 cm / 5.9"

21 cm / 8.3"

Shipper Colli	1
Gross Weight (kg)	9.5
Net Weight (kg)	7.1
Add-ons	Please visit planner.muuto.com/linear for recommended lighting, power and accessories
Warranty Period	5 years

Pattern No.	Color	Contract Price	Lead Time
Ready-To-Ship US Warehouse			
MLINSYTTR67-BLCK	Black	USD 450.00	-
MLINSYTTR67-OAK	Oak ***	USD 450.00	-

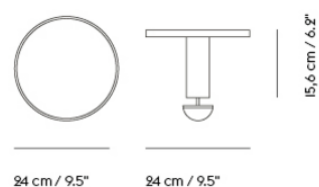
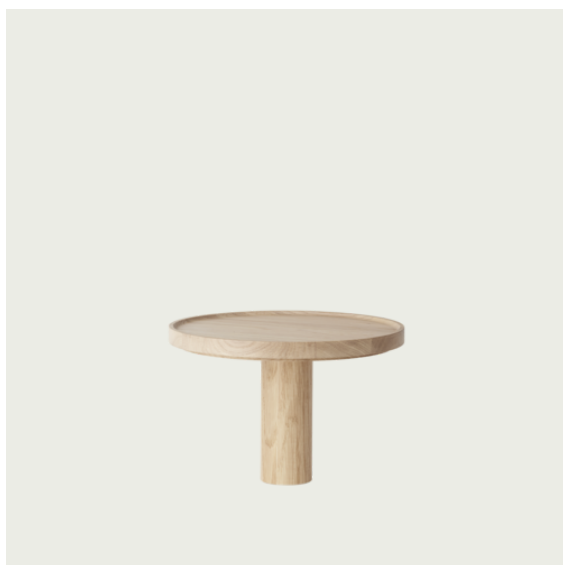

Shipper Colli	
Gross Weight (kg)	1.8
Net Weight (kg)	
Add-ons	Please visit planner.muuto.com/linear for recommended lighting, power and accessories
Warranty Period	5 years

Pattern No.	Color	Contract Price	Lead Time
Ready-To-Ship US Warehouse			
MLINSYTT09-BLCK	Black	USD 226.00	-
MLINSYTT09-OAK	Oak	USD 226.00	-

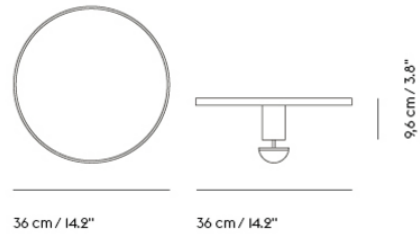

Shipper Colli	1
Gross Weight (kg)	2.7
Net Weight (kg)	1.7
Add-ons	Please visit planner.muuto.com/linear for recommended lighting, power and accessories
Warranty Period	5 years

Pattern No.	Color	Contract Price	Lead Time
Ready-To-Ship US Warehouse			
MLINSYTT014-BLCK	Black	USD 236.00	-
MLINSYTT014-OAK	Oak	USD 236.00	-

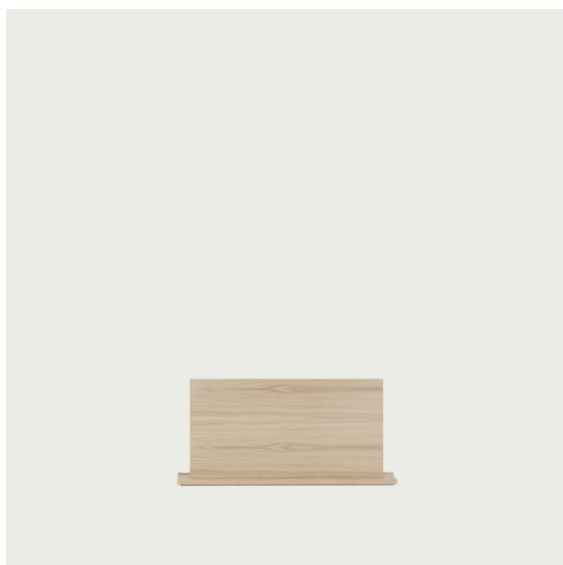

75 cm / 29.5"



35 cm / 13.8"

15 cm / 5.9"

Shipper Colli	1
Gross Weight (kg)	7.1
Net Weight (kg)	5.2
Add-ons	Please visit planner.muuto.com/linear for recommended lighting, power and accessories
Warranty Period	5 years

Pattern No.	Color	Contract Price	Lead Time
Ready-To-Ship US Warehouse			
MLINSYSW29-BLCK	Black	USD 383.00	-
MLINSYSW29-OAK	Oak	USD 383.00	-



125 cm / 49.2"

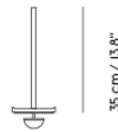

15 cm / 5.9"

Shipper Colli	1
Gross Weight (kg)	10.9
Net Weight (kg)	8.9
Add-ons	Please visit planner.muuto.com/linear for recommended lighting, power and accessories
Warranty Period	5 years

Pattern No.	Color	Contract Price	Lead Time
Ready-To-Ship US Warehouse			
MLINSYSW49-BLCK	Black	USD 520.00	-
MLINSYSW49-OAK	Oak	USD 520.00	-



178 cm / 70.1"

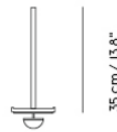

15 cm / 5.9"

Shipper Colli	1
Gross Weight (kg)	15.4
Net Weight (kg)	12.8
Add-ons	Please visit planner.muuto.com/linear for recommended lighting, power and accessories
Warranty Period	5 years

Pattern No.	Color	Contract Price	Lead Time
Ready-To-Ship US Warehouse			
MLINSYSW70-BLCK	Black	USD 681.00	-
MLINSYSW70-OAK	Oak	USD 681.00	-



- Shipper Colli** | 1
- Gross Weight (kg)** | 1.832
- Net Weight (kg)** | 1.3
- Bulb included** | Yes. Integrated, dimmable, non-replaceable LED module.
- Add-ons** | Please visit planner.muuto.com/linear for recommended lighting, power and accessories
- Warranty Period** | 5 years

Pattern No.	Color	Contract Price	Lead Time
Ready-To-Ship US Warehouse			
MLINLTBLP-BLCK	Black	USD 492.00	-
MLINLTBLP-GREY	Grey	USD 492.00	-

LINEAR MOUNTED LAMP / 209,2 CM / 82.4"

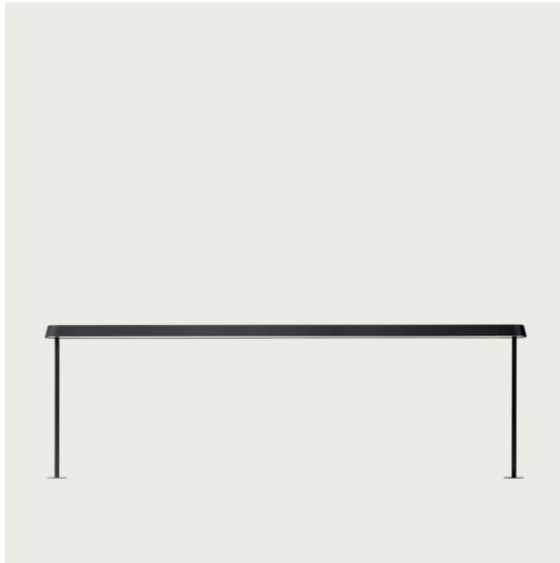

- Shipper Colli 1
- Gross Weight (kg) 7.8
- Net Weight (kg) 4.8
- Please note Only usable with Linear System Power Kit. The connector pins in this product contains lead, CAS no. 7439-92-1.
- Bulb included Yes. Integrated non-replaceable LED.
- Warranty Period 5 years

Pattern No.	Color	Contract Price	Lead Time
Ready-To-Ship US Warehouse			
MLINSYML82-BLCK	Black	USD 2,046.00	-
MLINSYML82-GREY	Grey	USD 2,046.00	-

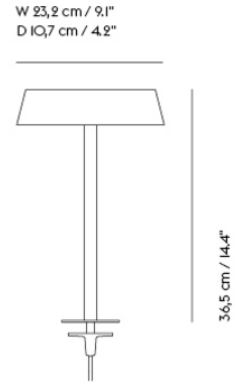

Shipper Colli	1
Gross Weight (kg)	1.5
Net Weight (kg)	1
Please note	1. Only usable with Linear System Power Kit. The connector pins in this product contains lead, CAS no. 7439-92-
Bulb included	Yes. Integrated non-replaceable LED.
Warranty Period	5 years

Pattern No.	Color	Contract Price	Lead Time
Ready-To-Ship US Warehouse			
MLINSYML9-BLCK	Black	USD 614.00	-
MLINSYML9-GREY	Grey	USD 614.00	-



W 169,2 cm / 66.6"
D 10,7 cm / 4.2"

Shipper Colli	1
Gross Weight (kg)	4.9
Net Weight (kg)	3.3
Bulb included	Yes. Integrated non-replaceable LED.
Warranty Period	5 years

Pattern No.	Color	Contract Price	Lead Time
Ready-To-Ship US Warehouse			
MLINLPDLP66-BLCK	Black	USD 1,465.00	-
MLINLPDLP66-GREY	Grey	USD 1,465.00	-



W 87,2 cm / 34,3"
D 10,7 cm / 4,2"

Shipper Colli	1
Gross Weight (kg)	3.2
Net Weight (kg)	2.2
Bulb included	Yes. Integrated non-replaceable LED.
Warranty Period	5 years

Pattern No.	Color	Contract Price	Lead Time
Ready-To-Ship US Warehouse			
MLINLPDLP34-BLCK	Black	USD 1,101.00	-
MLINLPDLP34-GREY	Grey	USD 1,101.00	-

LINEAR SYSTEM POWER CONFIGURATION



Gross Weight (kg) 0.7
Add-ons Please visit planner.muuto.com/linear for recommended lighting, power and accessories
Please note The connector pins in this product contains lead, CAS no. 7439-92-1
Warranty Period 5 years

Pattern No.	Color	Contract Price	Lead Time
Ready-To-Ship US Warehouse			
MLINSYPK	Linear System Power Configuration 1	USD 278.00	-
MLINSYPC2	Black - Configuration 2	USD 541.00	-
MLINSYPC3	Black - Configuration 3	USD 807.00	-

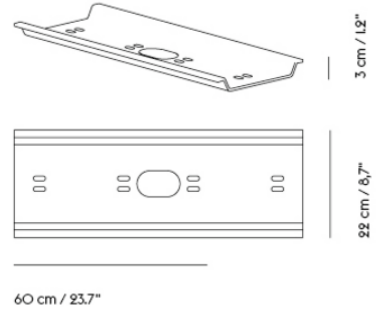

Shipper Colli	1
Gross Weight (kg)	0.212
Net Weight (kg)	0.181
Add-ons	Please visit planner.muuto.com/linear for recommended lighting, power and accessories
Warranty Period	5 years

Pattern No.	Color	Contract Price	Lead Time
Ready-To-Ship US Warehouse			
MLINSYCT	Dark Grey	USD 135.00	-

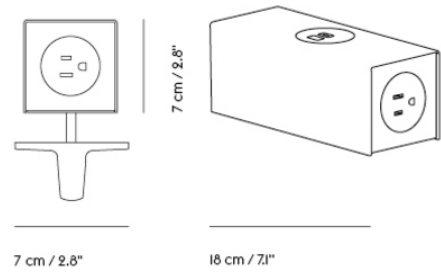

Shipper Colli	1
Gross Weight (kg)	1.5
Net Weight (kg)	1.4
Add-ons	Please visit planner.muuto.com/linear for recommended lighting, power and accessories
Warranty period	5 years

Pattern No.	Color	Contract Price	Lead Time
Ready-To-Ship US Warehouse			
MLINSYPO-BLCK	Black	USD 667.00	-
MLINSYPO-GREY	Grey	USD 667.00	-

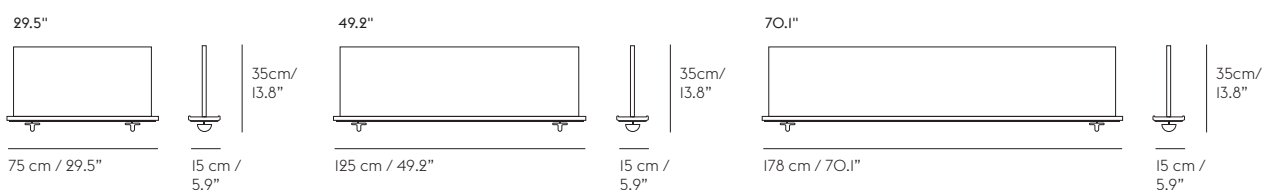

All Variants

Contract Price

All Variants	Pattern No.	Wood Screen	Upholstery Grades			
			A	B	C	E
29.5"	M-LINSYS-W-29	383				
	M-LINSYS-U-29		509	562	614	660
49.2"	M-LINSYS-W-49	520				
	M-LINSYS-U-49		667	734	828	898
70.1"	M-LINSYS-W-70	681				
	M-LINSYS-U-70		933	1,028	1,150	1,206

HOW TO CONFIGURE

Specify:

- Step 1: Choose variant
- Step 2: Choose base color
- Step 3: Choose textile
- Step 4: Choose textile color

ORDER CODE EXAMPLE:

Linear System Screen 49.2" Remix 133

Size	Linear System Screen 49.2"	M-LINSYS-U-49
Textile	Remix M156	
Textile Color	133	133
Final Pattern No:	MLINSYSU49M156133	

Upholstery Options

A	B	C	E
Ocean (M161)*	Beck (M6376)	Hallingdal (M146)	Acca (M12660)
Remix (M156)	Canvas (M153)		Divina (M150)
Wooly (M159)	Clara (M154)		Divina MD (M147)
	Fiord (M155)		Divina Melange (M135)
	Grain (M12659)		Ecriture (M01767)
	Manner (M12665)		Hearth (M12664)
	Re-Wool (M4586)		Twill Weave (M142)
	Sabi (M8404)		Vidar (M158)
	Steelcut (M149)		
	Steelcut Trio (M139)		

*Notes:
Ocean - Color 3, 21, 32, 50, 52, 80 & 601

LINEAR WOOD SERIES

FOR MORE INFORMATION,
EXPLORE BELOW

- ↗ [Product Fact Sheet](#)
- ↗ [Images](#)
- ↗ [Architect Files](#)
- ↗ [Assembly Instructions](#)
- ↗ [Product Declaration](#)

LINEAR WOOD TABLE / 140 X 85 CM / 55.1 X 31.5"

290

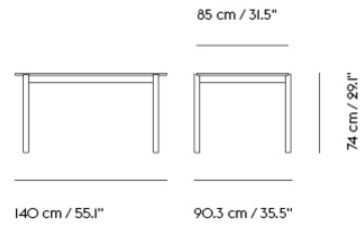

Shipper Colli	1
Gross Weight (kg)	25.5
Net Weight (kg)	18.494
Warranty Period	5 years

Pattern No.	Color	Contract Price	Lead Time
Ready-To-Ship US Warehouse			
MLINWT5532	Oak Veneer/Oak	USD 1,675.00	-
Extras			
MLINWTSCRK-BLCK	Screw Kit for Linear Wood	USD 23.00	-

LINEAR WOOD TABLE / 200 X 90 CM / 78.7 X 35.4"

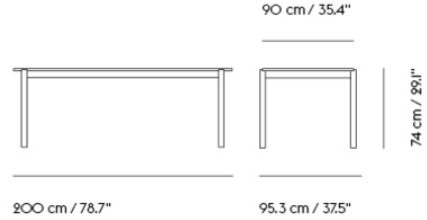

Shipper Colli	1
Gross Weight (kg)	36.6
Net Weight (kg)	28.664
Warranty Period	5 years

Pattern No.	Color	Contract Price	Lead Time
Ready-To-Ship US Warehouse			
MLINWT7933	Oak Veneer/Oak	USD 2,361.00	-
Extras			
MLINWTSCRK-BLCK	Screw Kit for Linear Wood	USD 23.00	-

LINEAR WOOD TABLE / 260 X 90 CM / 102.4 X 35.4"

292

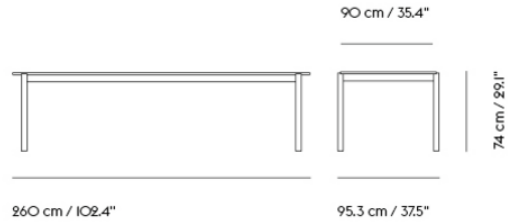

Shipper Colli	1
Gross Weight (kg)	43.6
Net Weight (kg)	34.714
Warranty Period	5 years

Pattern No.	Color	Contract Price	Lead Time
Ready-To-Ship US Warehouse			
MLINWT10336	Oak Veneer/Oak	USD 2,571.00	-
Extras			
MLINWTSCRK-BLCK	Screw Kit for Linear Wood	USD 23.00	-

LINEAR WOOD BENCH / 110 X 34 CM / 43.3 X 13.4"

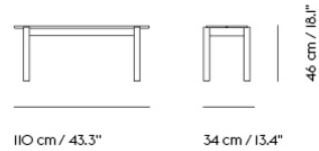

Shipper Colli 1
 Gross Weight (kg) 12
 Net Weight (kg) 7.034
 Warranty Period 10 years

Pattern No.	Color	Contract Price	Lead Time
Ready-To-Ship US Warehouse			
MLINWB43	Oak Veneer/Oak	USD 902.00	-
Extras			
MLINWTSCRK-BLCK	Screw Kit for Linear Wood	USD 23.00	-

LINEAR WOOD BENCH / 170 X 34 CM / 67 X 13.4"

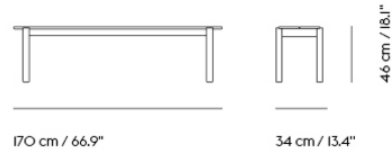

Shipper Colli 1
 Gross Weight (kg) 18.4
 Net Weight (kg) 12.894
 Warranty Period 10 years

Pattern No.	Color	Contract Price	Lead Time
Ready-To-Ship US Warehouse			
MLINWB67	Oak Veneer/Oak	USD 1,150.00	-
Extras			
MLINWTSCRK-BLCK	Screw Kit for Linear Wood	USD 23.00	-

LOFT CHAIR SERIES

FOR MORE INFORMATION,
EXPLORE BELOW

- ↗ [Product Fact Sheet](#)
- ↗ [Images](#)
- ↗ [Architect Files](#)
- ↗ [Product Declaration](#)
- ↗ [Product Configurator](#)

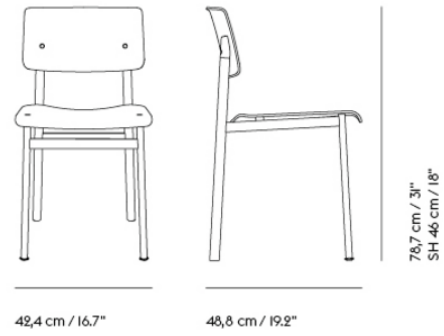

Shipper Colli	1
Gross Weight (kg)	15
Net Weight (kg)	6.6
Base color options	Black, Deep Red, Dusty Green or Grey
Warranty Period	10 years

Pattern No.	Color	Contract Price	Lead Time
Ready-To-Ship US Warehouse			
MLFTCW-BLCK-BLCK	Black/Black	USD 530.00	-
MLFTCW-BLCK-OAK	Oak/Black	USD 530.00	-
MLFTCW-DPRD-OAK	Oak/Deep Red	USD 530.00	-
MLFTCW-DGRN-OAK	Oak/Dusty Green	USD 530.00	-
MLFTCW-GREY-OAK	Oak/Grey	USD 530.00	-
MLFTCW-WHIT-OAK	Oak/White ***	USD 530.00	-
Extras			
MGLDLFSPB4	Felt glides for Loft Series (4 pcs per pack) - Black	USD 21.00	-
MLEAKIT	Leather care set for Refine Leather	USD 27.00	-

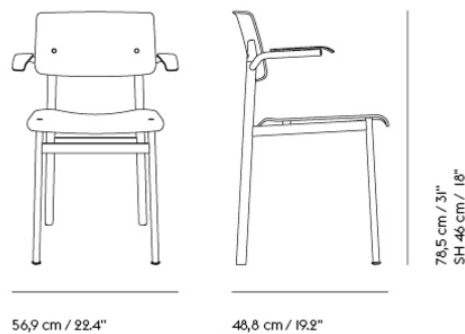

Shipper Colli 1
 Gross Weight (kg) 17
 Net Weight (kg) 7
 Warranty Period 10 Years

Pattern No.	Color	Contract Price	Lead Time
Ready-To-Ship US Warehouse			
MLFTCAW-BLCK-BLCK	Black/Black ***	USD 688.00	-
MLFTCAW-BLCK-OAK	Oak/Black ***	USD 688.00	-
MLFTCAW-DPRD-OAK	Oak/Deep Red ***	USD 688.00	-
MLFTCAW-DGRN-OAK	Oak/Dusty Green ***	USD 688.00	-
MLFTCAW-GREY-OAK	Oak/Grey ***	USD 688.00	-
MLFTCAW-BLCK-STDB	Stained Dark Brown/Black ***	USD 688.00	-
Extras			
MGLDLFSPB4	Felt glides for Loft Series (4 pcs per pack) - Black	USD 21.00	-

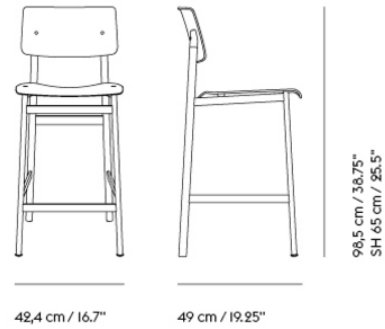

Shipper Colli	1
Gross Weight (kg)	11.55
Net Weight (kg)	8
Base color options	Black, Deep Red, Dusty Green or Grey
Warranty Period	10 years

Pattern No.	Color	Contract Price	Lead Time
Ready-To-Ship US Warehouse			
MLFTSTCW-BLCK-BLCK	Black/Black	USD 688.00	-
MLFTSTCW-BLCK-OAK	Oak/Black	USD 688.00	-
MLFTSTCW-DPRD-OAK	Oak/Deep Red	USD 688.00	-
MLFTSTCW-DGRN-OAK	Oak/Dusty Green	USD 688.00	-
MLFTSTCW-GREY-OAK	Oak/Grey	USD 688.00	-
Extras			
MGLDLFSPB4	Felt glides for Loft Series (4 pcs per pack) - Black	USD 21.00	-
MLEAKIT	Leather care set for Refine Leather	USD 27.00	-

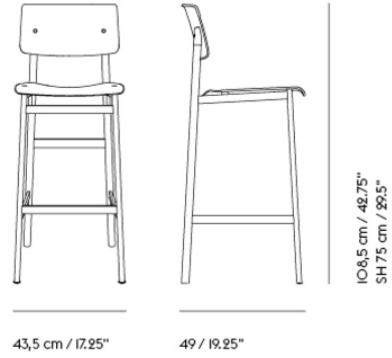

Shipper Colli	1
Gross Weight (kg)	12.05
Net Weight (kg)	8.5
Base color options	Black, Deep Red, Dusty Green or Grey
Warranty Period	10 years

Pattern No.	Color	Contract Price	Lead Time
-------------	-------	----------------	-----------

Ready-To-Ship US Warehouse

MLFTSTBW-BLCK-BLCK	Black/Black	USD 688.00	-
MLFTSTBW-BLCK-OAK	Oak/Black	USD 688.00	-
MLFTSTBW-DPRD-OAK	Oak/Deep Red	USD 688.00	-
MLFTSTBW-DGRN-OAK	Oak/Dusty Green	USD 688.00	-
MLFTSTBW-GREY-OAK	Oak/Grey	USD 688.00	-

Extras

MGLDLFSPB4	Felt glides for Loft Series (4 pcs per pack) - Black	USD 21.00	-
MLEAKIT	Leather care set for Refine Leather	USD 27.00	-



All Upholstery Variants

	Description	Pattern No.	Upholstery Grades								
			COM			CIL			COL		
			A	B	C	E	R	T	U	V	W
Loft Chair	Upholstered Seat	M-LFTC-U	734	776	824	845	866	919	954	1,101	1,206
Loft Counter Stool	Upholstered Seat	M-LFTST-C-U	902	944	1,013	1,028	1,049	1,150	1,150	1,206	1,206
Loft Bar Stool	Upholstered Seat	M-LFTST-B-U	902	944	1,013	1,028	1,049	1,150	1,150	1,206	1,206

HOW TO CONFIGURE

Loft Chair

- Specify:
 Step 1) Choose variant
 Step 2) Choose Base color
 Step 3) Choose Back/seat color
 Step 4) Choose Upholstery
 Step 5) Choose Upholstery color

ORDER CODE EXAMPLE: Loft w/upholstered Seat

Oak/Black Hallingdal 810

Variant	Loft Chair Upholstered seat	M-LFT-CU
Base Color	Black	BLCK
Back/seat color	Oak	OAK
Upholstery	Hallingdal	M146
Upholstery Color	226	810
Final Pattern No:	MLFTCUBLCKOAKM146810	

Base/Wood Options

Steel Base and Wooden Seat/back are combined as follows

- BLCK-BLCK - Black/Black wood
- BLCK-OAK - Black/Oak
- DGRN-OAK - Dusty Green/Oak
- GREY-OAK - Grey/Oak
- DPRD-OAK - Deep Red/Oak

Upholstery Options

A	B	C	E	R	T	U	V	W
Ocean (M161)* Remix (M156)	Beck (M6376) Canvas (M153) Clara (M154) Grain (M12659) Manner (M12665) Steelcut (M149) Steelcut Trio (M139)	Hallingdal (M146)	Acca (M12660) Divina (M150) Divina MD (M147) Divina Melange (M135) Ecriture (M10767) Hearth (M12664) Twill Weave (M142)	Easy Leather (M141)	Refine Leather (M136)	Endure Leather (M137)	Grace Leather (M12374)	Allure Leather (M12375)

*Notes:
Ocean - Color 3, 21, 32, 50, 52, 80 & 601

MIDST TABLE SERIES

FOR MORE INSPIRATION,
EXPLORE BELOW:

- ↗ [Product Fact Sheet](#)
- ↗ [Images](#)
- ↗ [Architect Files](#)
- ↗ [Assembly Instructions](#)
- ↗ [Product Declaration](#)

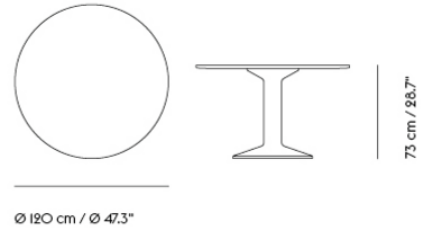

Shipper Colli	2
Gross Weight (kg)	67.09
Net Weight (kg)	48.996
Base color options	Black, Dark Red & Grey
Please note	Other color combinations are available upon request
Warranty Period	10 years

Pattern No.	Color	Contract Price	Lead Time
Ready-To-Ship EU Warehouse			
MMDSTT47-BLCK-BLCK	Black Linoleum/Black	USD 4,146.00	-
MMDSTT47-DKRD-DKRD	Dark Red Linoleum/Dark Red	USD 4,146.00	-
MMDSTT47-DOAK-BLCK	Dark Oiled Oak/Black	USD 4,405.00	-
MMDSTT47-DOAK-DKRD	Dark Oiled Oak/Dark Red	USD 4,405.00	-
MMDSTT47-DOAK-GREY	Dark Oiled Oak/Grey	USD 4,405.00	-
MMDSTT47-OAK-BLCK	Oiled Oak/Black	USD 4,405.00	-
MMDSTT47-OAK-DKRD	Oiled Oak/Dark Red	USD 4,405.00	-
MMDSTT47-OAK-GREY	Oiled Oak/Grey	USD 4,405.00	-
Made-To-Order			
MMDSTTFP47-BLKN-BLCK	Black Nanolaminate/Black	USD 4,881.00	15 weeks
MMDSTTFP47-GREY-GREY	Grey Linoleum/Grey	USD 4,671.00	15 weeks

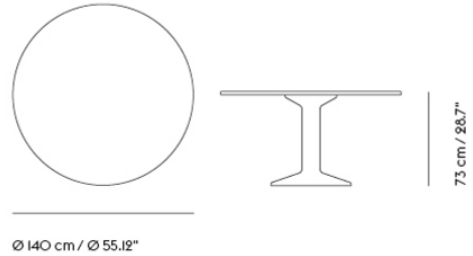

Shipper Colli	2
Gross Weight (kg)	108.15
Net Weight (kg)	83.1
Base color options	Black, Dark Red & Grey
Please note	Other color combinations are available upon request
Warranty Period	10 years

Pattern No.	Color	Contract Price	Lead Time
Ready-To-Ship EU Warehouse			
MMDSTTFP55-BLCK-BLCK	Black Linoleum/Black	USD 4,881.00	-
MMDSTTFP55-DKRD-DKRD	Dark Red Linoleum/Dark Red	USD 4,881.00	-
MMDSTTFP55-DOAK-BLCK	Dark Oiled Oak/Black	USD 5,196.00	-
MMDSTTFP55-DOAK-DKRD	Dark Oiled Oak/Dark Red	USD 5,196.00	-
MMDSTTFP55-DKRD-DKRD	Dark Oiled Oak/Grey	USD 5,196.00	-
MMDSTTFP55-OAK-BLCK	Oiled Oak/Black	USD 5,196.00	-
MMDSTTFP55-OAK-DKRD	Oiled Oak/Dark Red	USD 5,196.00	-
MMDSTTFP55-OAK-GREY	Oiled Oak/Grey	USD 5,196.00	-
Made-To-Order			
MMDSTTFP55-BLKN-BLCK	Black Nanolaminate/Black	USD 5,560.00	15 weeks
MMDSTTFP55-GREY-GREY	Grey Linoleum/Grey	USD 5,406.00	15 weeks

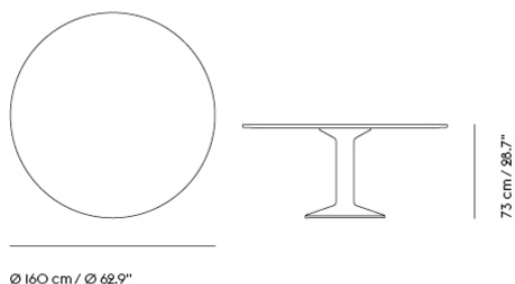

Shipper Colli	2
Gross Weight (kg)	96.98
Net Weight (kg)	74.217
Base color options	Black, Dark Red & Grey
Please note	Other color combinations are available upon request
Warranty Period	10 years

Pattern No.	Color	Contract Price	Lead Time
Ready-To-Ship EU Warehouse			
MMDSTT63-BLCK-BLCK	Black Linoleum/Black	USD 5,770.00	-
MMDSTT63-DKRD-DKRD	Dark Red Linoleum/Dark Red	USD 5,770.00	-
MMDSTT63-DOAK-BLCK	Dark Oiled Oak/Black	USD 6,715.00	-
MMDSTT63-DOAK-DKRD	Dark Oiled Oak/Dark Red	USD 6,715.00	-
MMDSTT63-DOAK-GREY	Dark Oiled Oak/Grey	USD 6,715.00	-
MMDSTT63-OAK-BLCK	Oiled Oak/Black	USD 6,715.00	-
MMDSTT63-OAK-DKRD	Oiled Oak/Dark Red	USD 6,715.00	-
MMDSTT63-OAK-GREY	Oiled Oak/Grey	USD 6,715.00	-
Made-To-Order			
MMDSTTFP63-GREY-GREY	Grey Linoleum/Grey	USD 6,295.00	15 weeks

MIDST TABLE / Ø 120 CM / 47.25" - W. POWER CUT-OUT

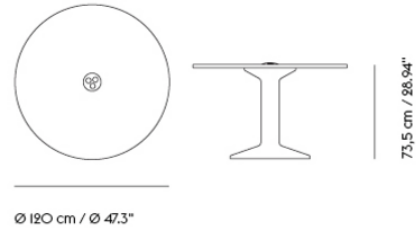

Shipper Colli	2
Gross Weight (kg)	78.75
Net Weight (kg)	55.7
Base color options	Black, Dark Red & Grey
Please note	Power Units are purchased separately
Please note	Other color combinations are available upon request
Warranty Period	10 years

Pattern No.	Color	Contract Price	Lead Time
Made-To-Order			
MMDSTTFP47-BLKN-BLCK	Black Nanolaminate/Black	USD 4,881.00	15 weeks
MMDSTTFP47-BLCK-BLCK	Black Linoleum/Black	USD 4,671.00	15 weeks
MMDSTTFP47-BLCK-DKRD	Dark Red Linoleum/Dark Red	USD 4,671.00	15 weeks
MMDSTTFP47-BLCK-GREY	Grey Linoleum/Grey	USD 4,671.00	15 weeks
Extras			
MMDSTPOPC1	Pandora Power Unit - V1 (3 x National Plugs) - US	USD 625.00	6 weeks
MMDSTPOPC2	Pandora Power Unit - V2 (2 x National Plug + 1 x TUF-R A+C 25W) - US	USD 824.00	6 weeks

MIDST TABLE / Ø 140 CM / 55.1" - W. POWER CUT-OUT

306

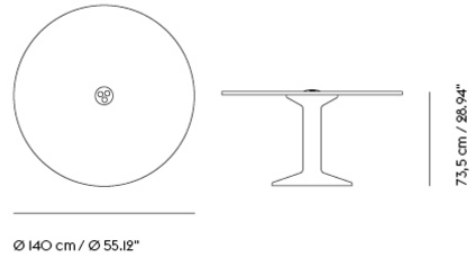

Shipper Colli	2
Gross Weight (kg)	108.15
Net Weight (kg)	83.1
Base color options	Black, Dark Red & Grey
Please note	Power Units are purchased separately
Please note	Other color combinations are available upon request
Warranty Period	10 years

Pattern No.	Color	Contract Price	Lead Time
Made-To-Order			
MMDSTTFP55-BLKN-BLCK	Black Nanolaminate/Black	USD 5,560.00	15 weeks
MMDSTTFP55-BLCK-BLCK	Black Linoleum/Black	USD 5,406.00	15 weeks
MMDSTTFP55-DKRD-DKRD	Dark Red Linoleum/Dark Red	USD 5,406.00	15 weeks
MMDSTTFP55-GREY-GREY	Grey Linoleum/Grey	USD 5,406.00	15 weeks
Extras			
MMDSTPOPDC1	Pandora Power Unit - V1 (3 x National Plugs) - US	USD 625.00	6 weeks
MMDSTPOPDC2	Pandora Power Unit - V2 (2 x National Plug + 1 x TUF-R A+C 25W) - US	USD 824.00	6 weeks

MIDST TABLE / Ø 160 CM / 63" - W.
POWER CUT-OUT

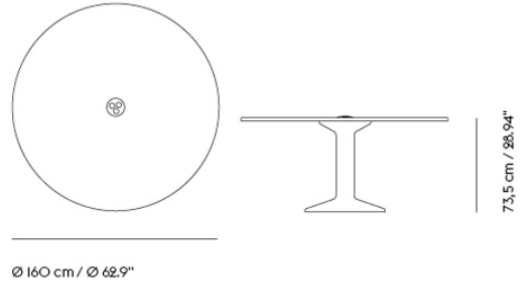

Shipper Colli	2
Gross Weight (kg)	120.15
Net Weight (kg)	93.1
Base color options	Black, Dark Red & Grey
Please note	Power Units are purchased separately
Please note	Other color combinations are available upon request
Warranty Period	10 years

Pattern No.	Color	Contract Price	Lead Time
Made-To-Order			
MMDSTTFP55-BLCK-BLCK	Black Linoleum/Black	USD 6,295.00	15 weeks
MMDSTTFP55-DKRD-DKRD	Dark Red Linoleum/Dark Red	USD 6,295.00	15 weeks
MMDSTTFP55-GREY-GREY	Grey Linoleum/Grey	USD 6,295.00	15 weeks
Extras			
MMDSTPOPDC1	Pandora Power Unit - V1 (3 x National Plugs) - US	USD 625.00	6 weeks
MMDSTPOPDC2	Pandora Power Unit - V2 (2 x National Plug + 1 x TUF-R A+C 25W) - US	USD 824.00	6 weeks

MIDST CONFERENCE TABLE / 330 X 140 CM / 130 X 55.1"

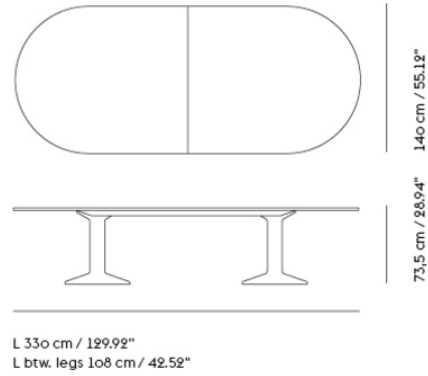

Shipper Colli	4
Gross Weight (kg)	246.6
Net Weight (kg)	138.4
Base color options	Black, Dark Red & Grey
Please note	Other color combinations are available upon request
Warranty Period	10 years

Pattern No.	Color	Contract Price	Lead Time
Made-To-Order			
MMDSCT118-BLKN	Black Nanolaminate/Black	USD 10,341.00	15 weeks
MMDSCT118-BLCK	Black Linoleum/Black	USD 9,865.00	15 weeks
MMDSCT118-DKRD	Dark Red Linoleum/Dark Red	USD 9,865.00	15 weeks
MMDSCT118-GREY	Grey Linoleum/Grey	USD 9,865.00	15 weeks

MIDST CONFERENCE TABLE / 395 X 140 CM / 155.5 X 55.1"

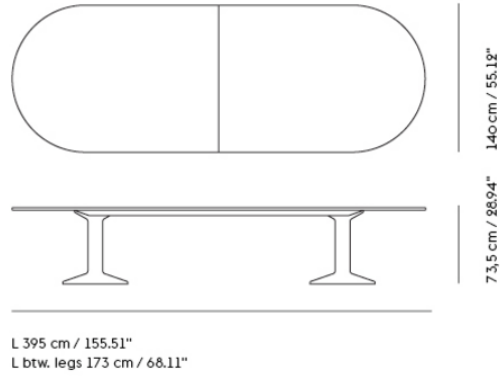

Shipper Colli	4
Gross Weight (kg)	270.4
Net Weight (kg)	158.2
Base color options	Black, Dark Red & Grey
Please note	Other color combinations are available upon request
Warranty Period	10 years

Pattern No.	Color	Contract Price	Lead Time
Made-To-Order			
MMDSCT1211-BLKN	Black Nanolaminat/Black	USD 11,545.00	15 weeks
MMDSCT1211-BLCK	Black Linoleum/Black	USD 11,020.00	15 weeks
MMDSCT1211-DKRD	Dark Red Linoleum/Dark Red	USD 11,020.00	15 weeks
MMDSCT1211-GREY	Grey Linoleum/Grey	USD 11,020.00	15 weeks

MIDST CONFERENCE TABLE / 460 X 140 CM / 181.1 X 55.1"

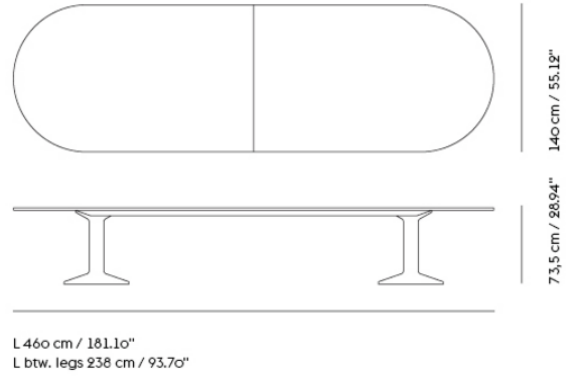

Shipper Colli	4
Gross Weight (kg)	281.3
Net Weight (kg)	176.1
Base color options	Black, Dark Red & Grey
Please note	Other color combinations are available upon request
Warranty Period	10 years

Pattern No.	Color	Contract Price	Lead Time
Made-To-Order			
MMDSCT151-BLKN	Black Nanolaminate/Black	USD 12,595.00	15 weeks
MMDSCT151-BLCK	Black Linoleum/Black	USD 12,070.00	15 weeks
MMDSCT151-DKRD	Dark Red Linoleum/Dark Red	USD 12,070.00	15 weeks
MMDSCT151-GREY	Grey Linoleum/Grey	USD 12,070.00	15 weeks

MIDST CONFERENCE TABLE / 330 X 140 CM / 130 X 55.1" - W. POWER CUT-OUT (2 X PANDORA POWER UNIT)

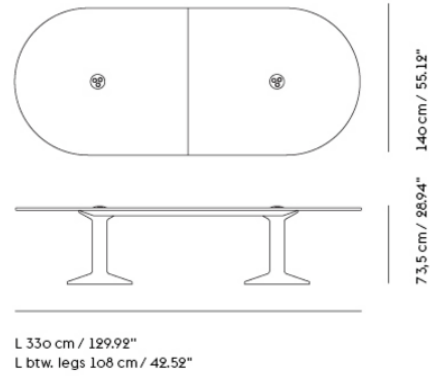

- Shipper Colli** 4
- Gross Weight (kg)** 246.6
- Net Weight (kg)** 138.4
- Base color options** Black, Dark Red & Grey
- Please note** Power Units are purchased separately
- Please note** Other color combinations are available upon request
- Warranty Period** 10 years

Pattern No.	Color	Contract Price	Lead Time
Made-To-Order			
MMDSCTFP2P118-BLKN	Black Nanolaminate/Black	USD 10,341.00	15 weeks
MMDSCTFP2P118-BLCK	Black Linoleum/Black	USD 9,865.00	15 weeks
MMDSCTFP2P118-DKRD	Dark Red Linoleum/Dark Red	USD 9,865.00	15 weeks
MMDSCTFP2P118-GREY	Grey Linoleum/Grey	USD 9,865.00	15 weeks
Extras			
MMDSTPOPDC1	Pandora Power Unit - VI (3 x National Plugs) - US	USD 625.00	6 weeks
MMDSTPOPDC2	Pandora Power Unit - V2 (2 x National Plug + 1 x TUF-R A+C 25W) - US	USD 824.00	6 weeks

MIDST CONFERENCE TABLE / 330 X 140 CM / 130 X 55.1" - W. POWER CUT-OUT (1 X CENTER POWER UNIT)

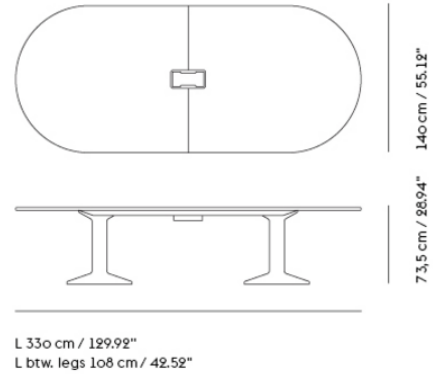

Shipper Colli	4
Gross Weight (kg)	246.6
Net Weight (kg)	138.4
Base color options	Black, Dark Red & Grey
Please note	Power Units are purchased separately
Please note	Other color combinations are available upon request
Warranty Period	10 years

Pattern No.	Color	Contract Price	Lead Time
Made-To-Order			
MMDSCTFP1C118-BLKN	Black Nanolaminate/Black	USD 10,341.00	15 weeks
MMDSCTFP1C118-BLCK	Black Linoleum/Black	USD 9,865.00	15 weeks
MMDSCTFP1C118-DKRD	Dark Red Linoleum/Dark Red	USD 9,865.00	15 weeks
MMDSCTFP1C118-GREY	Grey Linoleum/Grey	USD 9,865.00	15 weeks
Extras			
MMDSTPOCT1	Center Power Unit (4 x National Plugs + 2 x QFI5 TUF USB A + USB C HP + 1 x Cat6 3m + 1 x HDMI 3m) - US	USD 1,626.00	6 weeks

MIDST CONFERENCE TABLE / 395 X 140 CM / 155.5 X 55.1" - W. POWER CUT-OUT (2 X PANDORA POWER UNIT)

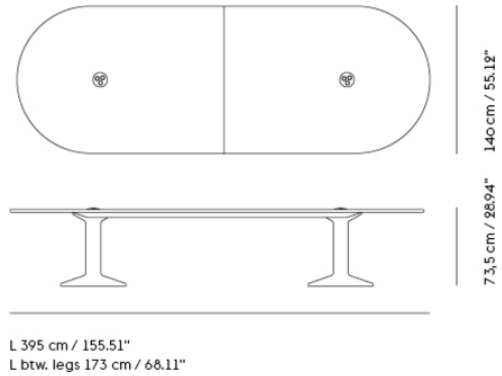

- Shipper Colli** 4
- Gross Weight (kg)** 270.4
- Net Weight (kg)** 158.2
- Base color options** Black, Dark Red & Grey
- Please note** Power Units are purchased separately
- Please note** Other color combinations are available upon request
- Warranty Period** 10 years

Pattern No.	Color	Contract Price	Lead Time
Made-To-Order			
MMDSCTFP2P1211-BLKN	Black Nanolaminate/Black	USD 11,545.00	15 weeks
MMDSCTFP2P1211-BLCK	Black Linoleum/Black	USD 11,020.00	15 weeks
MMDSCTFP2P1211-DKRD	Dark Red Linoleum/Dark Red	USD 11,020.00	15 weeks
MMDSCTFP2P1211-GREY	Grey Linoleum/Grey	USD 11,020.00	15 weeks
Extras			
MMDSTPOPC1	Pandora Power Unit - VI (3 x National Plugs) - US	USD 625.00	6 weeks
MMDSTPOPC2	Pandora Power Unit - V2 (2 x National Plug + 1 x TUF-R A+C 25W) - US	USD 824.00	6 weeks

MIDST CONFERENCE TABLE / 395 X 140 CM / 155.5 X 55.1" - W. POWER CUT-OUT (1 X CENTER POWER UNIT)

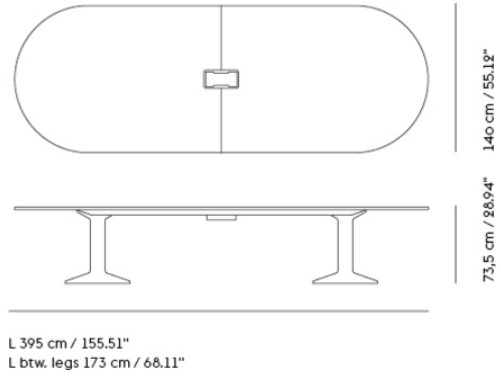

- Shipper Colli 4
- Gross Weight (kg) 270.4
- Net Weight (kg) 158.2
- Base color options Black, Dark Red & Grey
- Please note Power Units are purchased separately
- Please note Other color combinations are available upon request
- Warranty Period 10 years

Pattern No.	Color	Contract Price	Lead Time
Made-To-Order			
MMDSCTFP1C1211-BLKN	Black Nanolaminate/Black	USD 11,545.00	15 weeks
MMDSCTFP1C1211-BLCK	Black Linoleum/Black	USD 11,020.00	15 weeks
MMDSCTFP1C1211-DKRD	Dark Red Linoleum/Dark Red	USD 11,020.00	15 weeks
MMDSCTFP1C1211-GREY	Grey Linoleum/Grey	USD 11,020.00	15 weeks
Extras			
MMDSTPOCT1	Center Power Unit (4 x National Plugs + 2 x QFI5 TUF USB A + USB C HP + 1 x Cat6 3m + 1 x HDMI 3m) - US	USD 1,626.00	6 weeks

MIDST CONFERENCE TABLE / 460 X 140 CM / 181.1 X 55.1" - W. POWER CUT-OUT (2 X PANDORA POWER UNIT)

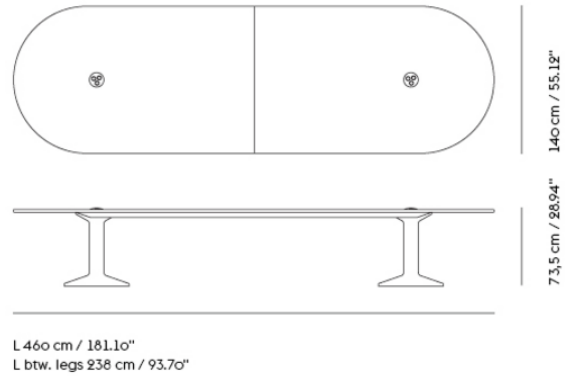

Shipper Colli	4
Gross Weight (kg)	281.3
Net Weight (kg)	176.1
Base color options	Black, Dark Red & Grey
Please note	Power Units are purchased separately
Please note	Other color combinations are available upon request
Warranty Period	10 years

Pattern No.	Color	Contract Price	Lead Time
Made-To-Order			
MMDSCTFP2P151-BLKN	Black Nanolaminate/Black	USD 12,595.00	15 weeks
MMDSCTFP2P151-BLCK	Black Linoleum/Black	USD 12,070.00	15 weeks
MMDSCTFP2P151-DKRD	Dark Red Linoleum/Dark Red	USD 12,070.00	15 weeks
MMDSCTFP2P151-GREY	Grey Linoleum/Grey	USD 12,070.00	15 weeks
Extras			
MMDSTPOPC1	Pandora Power Unit - VI (3 x National Plugs) - US	USD 625.00	6 weeks
MMDSTPOPC2	Pandora Power Unit - V2 (2 x National Plug + 1 x TUF-R A+C 25W) - US	USD 824.00	6 weeks

MIDST CONFERENCE TABLE / 460 X 140 CM / 181.1 X 55.1" - W. POWER CUT-OUT (1 X CENTER POWER UNIT)

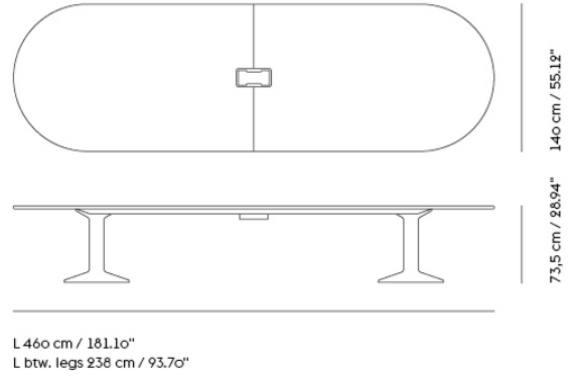

- Shipper Colli 4
- Gross Weight (kg) 281.3
- Net Weight (kg) 176.1
- Base color options Black, Dark Red & Grey
- Please note Power Units are purchased separately
- Please note Other color combinations are available upon request
- Warranty Period 10 years

Pattern No.	Color	Contract Price	Lead Time
Made-To-Order			
MMDSCTFP1C151-BLKN	Black Nanolaminate/Black	USD 12,595.00	15 weeks
MMDSCTFP1C151-BLCK	Black Linoleum/Black	USD 12,070.00	15 weeks
MMDSCTFP1C1511-DKRD	Dark Red Linoleum/Dark Red	USD 12,070.00	15 weeks
MMDSCTFP1C1511-GREY	Grey Linoleum/Grey	USD 12,070.00	15 weeks
Extras			
MMDSTPOCT1	Center Power Unit (4 x National Plugs + 2 x QFI5 TUF USB A + USB C HP + 1 x Cat6 3m + 1 x HDMI 3m) - US	USD 1,626.00	6 weeks

MINI STACKED STORAGE SYSTEM

FOR MORE INFORMATION,
EXPLORE BELOW

- ↗ [Product Fact Sheet](#)
- ↗ [Images](#)
- ↗ [Architect Files](#)
- ↗ [Assembly Instructions](#)
- ↗ [Product Declaration](#)
- ↗ [Product Planner](#)

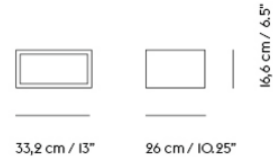
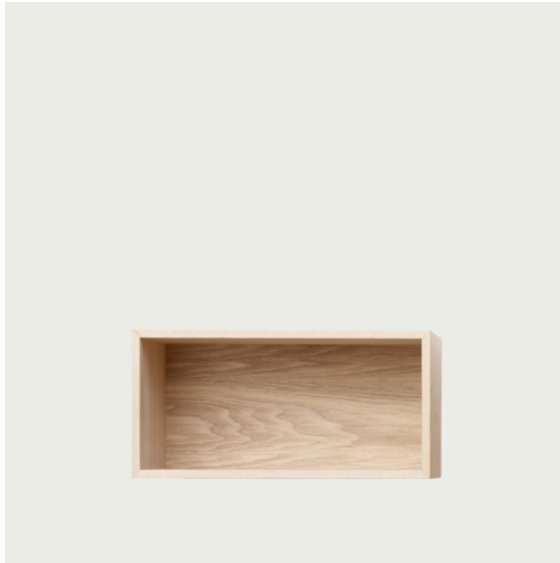

Shipper Colli 1
Gross Weight (kg) 4.2
Net Weight (kg) 2.7
Warranty Period 5 years

Pattern No.	Color	Contract Price	Lead Time
Ready-To-Ship US Warehouse			
MMSTMSM-BRGR	Brown Green	USD 226.00	-
MMSTMSM-GREY	Grey ***	USD 226.00	-
MMSTMSM-MBLU	Midnight Blue ***	USD 226.00	-
MMSTMSM-OAK	Oak	USD 226.00	-
MMSTMSM-WHIT	White	USD 226.00	-
Extras			
MMSTMSMMGKT	Mini Stacked Wall Mount Set - Small Modules	USD 7.00	-

MINI STACKED STORAGE SYSTEM / MEDIUM

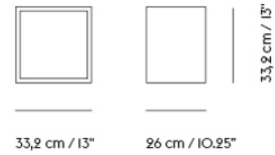

Shipper Colli 1
Gross Weight (kg) 5.5
Net Weight (kg) 3.7
Warranty Period 5 years

Pattern No.	Color	Contract Price	Lead Time
Ready-To-Ship US Warehouse			
MMSTMMD-BRGR	Brown Green	USD 226.00	-
MMSTMMD-GREY	Grey ***	USD 226.00	-
MMSTMMD-OAK	Oak	USD 226.00	-
MMSTMMD-OLIGY	Oak/Grey ***	USD 226.00	-
MMSTMMD-WHIT	White	USD 226.00	-
Extras			
MMSTMMDMGKT	Mini Stacked Wall Mount Set - Medium Modules	USD 7.00	-

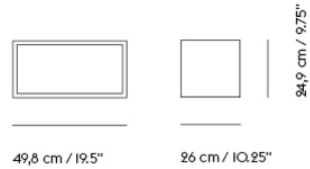

Shipper Colli 1
Gross Weight (kg) 6.195
Net Weight (kg) 4.3
Warranty Period 5 years

Pattern No.	Color	Contract Price	Lead Time
Ready-To-Ship US Warehouse			
MMSTMLG-BRGR	Brown Green	USD 236.00	-
MMSTMLG-GREY	Grey ***	USD 236.00	-
MMSTMLG-MBLU	Midnight Blue ***	USD 236.00	-
MMSTMLG-OAK	Oak	USD 236.00	-
MMSTMLG-WHIT	White	USD 236.00	-
Extras			
MMSTMLGMGKT	Mini Stacked Wall Mount Set - Large Modules	USD 7.00	-

MINI STACKED STORAGE SYSTEM / EXTRA CLIPS (1 PC)

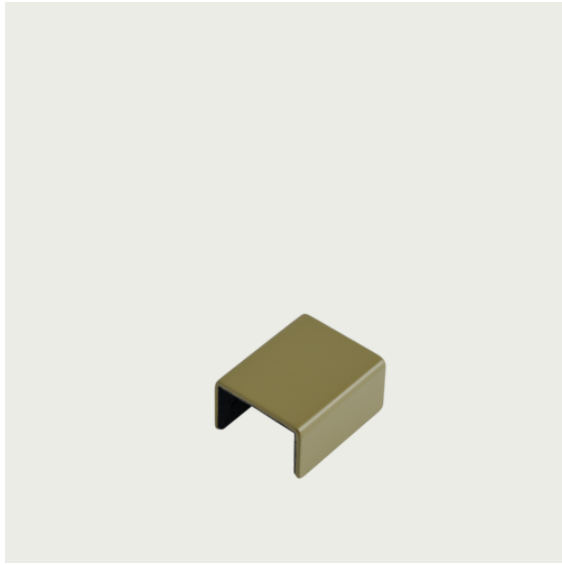

Shipper Colli 1
Gross Weight (kg) 0.016
Net Weight (kg) 0.014
Warranty Period 5 years

Pattern No.	Color	Contract Price	Lead Time
Ready-To-Ship US Warehouse			
MMSTC1PC-BRGR	Brown Green	USD 18.00	-
MMSTC1PC/GREY	Grey	USD 18.00	-
MMSTC1PC/WHIT	White	USD 18.00	-

NERD CHAIR SERIES

FOR MORE INFORMATION,
EXPLORE BELOW

- ↗ [Product Fact Sheet](#)
- ↗ [Images](#)
- ↗ [Architect Files](#)
- ↗ [Product Declaration](#)

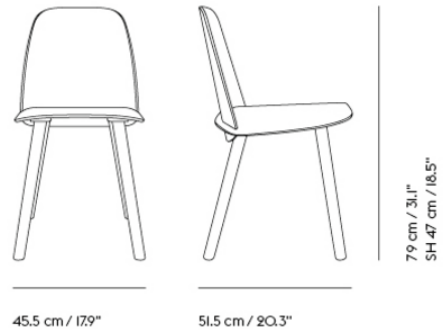

Shipper Colli | 1
Gross Weight (kg) 6.9
Net Weight (kg) 4.5
Warranty Period 5 years

Pattern No.	Color	Contract Price	Lead Time
Ready-To-Ship US Warehouse			
MNRDCW-BLCK	Black	USD 572.00	-
MNRDCW-GREN	Green	USD 572.00	-
MNRDCW-GREY	Grey	USD 572.00	-
MNRDCW-MBLU	Midnight Blue	USD 572.00	-
MNRDCW-OAK	Oak	USD 572.00	-
MNRDCW-SYEL	Sand Yellow ***	USD 572.00	-
MNRDCW-STDB	Stained Dark Brown	USD 572.00	-
MNRDCW-TROS	Tan Rose	USD 572.00	-
MNRDCW-WHIT	White	USD 572.00	-

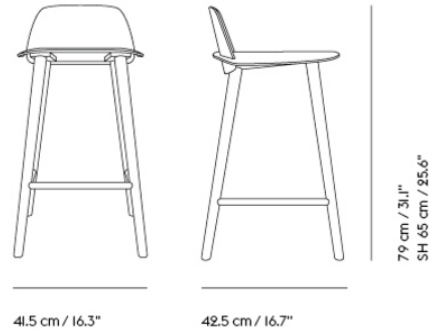

Shipper Colli 1
 Gross Weight (kg) 5.6
 Net Weight (kg) 4.3
 Warranty Period 5 years

Pattern No.	Color	Contract Price	Lead Time
Ready-To-Ship US Warehouse			
MNRDSTCW-BLCK	Black	USD 667.00	-
MNRDSTCW-GREN	Green	USD 667.00	-
MNRDSTCW-GREY	Grey	USD 667.00	-
MNRDSTCW-MBLU	Midnight Blue	USD 667.00	-
MNRDSTCW-OAK	Oak	USD 667.00	-
MNRDSTCW-STD	Stained Dark Brown	USD 667.00	-
MNRDSTCW-TROS	Tan Rose	USD 667.00	-
Made-To-Order			
MNRDSTCWF-BLCK	Black - With Steel Foot Protect	USD 719.00	13-15 weeks
MNRDSTCWF-GREN	Green - With Steel Foot Protect	USD 719.00	13-15 weeks
MNRDSTCWF-GREY	Grey - With Steel Foot Protect	USD 719.00	13-15 weeks
MNRDSTCWF-MBLU	Midnight Blue - With Steel Foot Protect	USD 719.00	13-15 weeks
MNRDSTCWF-OAK	Oak - With Steel Foot Protect	USD 719.00	13-15 weeks
MNRDSTCWF-SYEL	Sand Yellow - With Steel Foot Protect	USD 719.00	13-15 weeks
MNRDSTCWF-STD	Stained Dark Brown - With Steel Foot Protect	USD 719.00	13-15 weeks
MNRDSTCWF-TROS	Tan Rose - With Steel Foot Protect	USD 719.00	13-15 weeks
Extras			
MFTRSTN	Steel Footrest Protector - Self-Mounting	USD 48.00	-

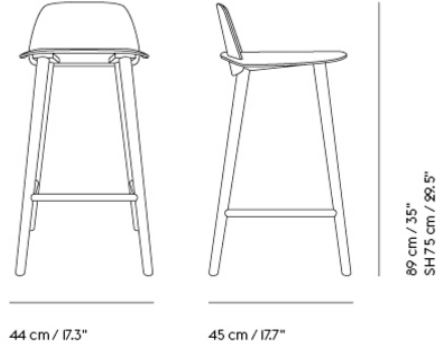

Shipper Colli 1
 Gross Weight (kg) 5.6
 Net Weight (kg) 4.3
 Warranty Period 5 years

Pattern No.	Color	Contract Price	Lead Time
Ready-To-Ship US Warehouse			
MNRDSTBW-BLCK	Black	USD 667.00	-
MNRDSTBW-GREN	Green	USD 667.00	-
MNRDSTBW-GREY	Grey	USD 667.00	-
MNRDSTBW-MBLU	Midnight Blue	USD 667.00	-
MNRDSTBW-OAK	Oak	USD 667.00	-
MNRDSTBW-SYEL	Sand Yellow ***	USD 667.00	-
MNRDSTBW-STD	Stained Dark Brown	USD 667.00	-
MNRDSTBW-TROS	Tan Rose	USD 667.00	-
MNRDSTBW-WHIT	White	USD 667.00	-
Made-To-Order			
MNRDSTBWF-BLCK	Black - With Steel Foot Protect	USD 719.00	13-15 weeks
MNRDSTBWF-GREN	Green - With Steel Foot Protect	USD 719.00	13-15 weeks
MNRDSTBWF-GREY	Grey - With Steel Foot Protect	USD 719.00	13-15 weeks
MNRDSTBWF-MBLU	Midnight Blue - With Steel Foot Protect	USD 719.00	13-15 weeks
MNRDSTBWF-OAK	Oak - With Steel Foot Protect	USD 719.00	13-15 weeks
MNRDSTBWF-SYEL	Sand Yellow - With Steel Foot Protect	USD 719.00	13-15 weeks
MNRDSTBWF-STD	Stained Dark Brown - With Steel Foot Protect	USD 719.00	13-15 weeks
MNRDSTBWF-TROS	Tan Rose - With Steel Foot Protect	USD 719.00	13-15 weeks
Extras			
MFTRSTN	Steel Footrest Protector - Self-Mounting	USD 48.00	-

OSLO CHAIR SERIES

FOR MORE INFORMATION,
EXPLORE BELOW

- ↗ [Product Fact Sheet](#)
- ↗ [Images](#)
- ↗ [Architect Files](#)
- ↗ [Product Declaration](#)
- ↗ [Product Configurator](#)

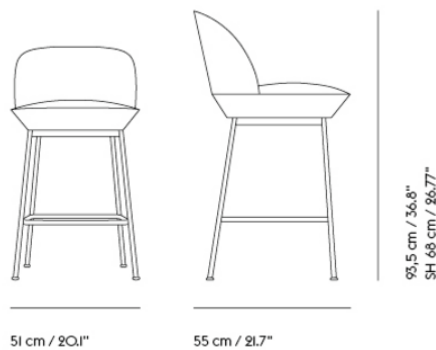
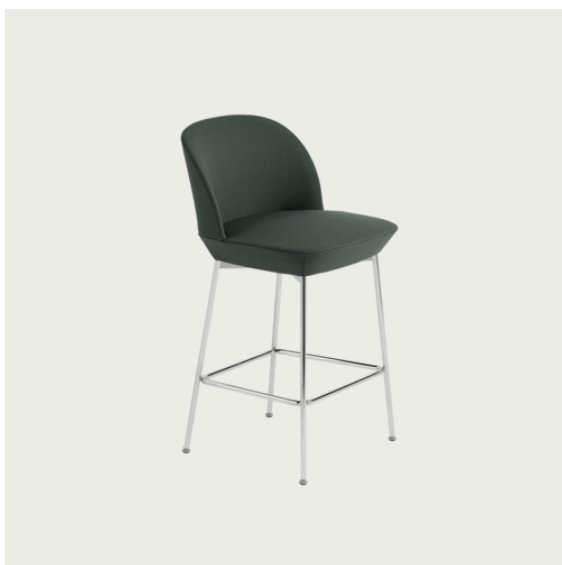

Shipper Colli	1
Gross Weight (kg)	10
Net Weight (kg)	8
Base color options	Chrome or Anthracite Black
Warranty Period	10 years

Pattern No.	Color	Contract Price	Lead Time
-------------	-------	----------------	-----------

Ready-To-Ship US Warehouse

MOSLSTCU-CHRO-M16132	Ocean 32/Chrome ***	USD 1,045.00	-
----------------------	---------------------	--------------	---

Extras

MGLDOFVTBPB1	Plastic glides for Fiber, Oslo and Visu with Tube Base (1 pc per pack) - Black	USD 6.00	-
MGLDOFVTBFB4	Felt Glides for Fiber, Oslo and Visu with Tube Base (4 pcs per pack)	USD 21.00	-

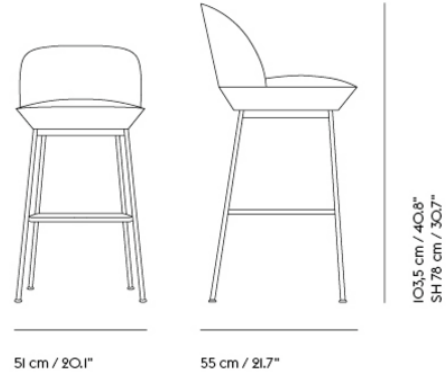

Shipper Colli	I
Gross Weight (kg)	11
Net Weight (kg)	8.2
Base color options	Chrome or Anthracite Black
Warranty Period	10 years

Pattern No.	Color	Contract Price	Lead Time
Ready-To-Ship US Warehouse			
MOSLSTBU-CHRO-M16132	Ocean 32/Chrome ***	USD 1,045.00	-
Extras			
MGLDOFVTBPB1	Plastic glides for Fiber, Oslo and Visu with Tube Base (1 pc per pack) - Black	USD 6.00	-
MGLDOFVTBFB4	Felt Glides for Fiber, Oslo and Visu with Tube Base (4 pcs per pack)	USD 21.00	-

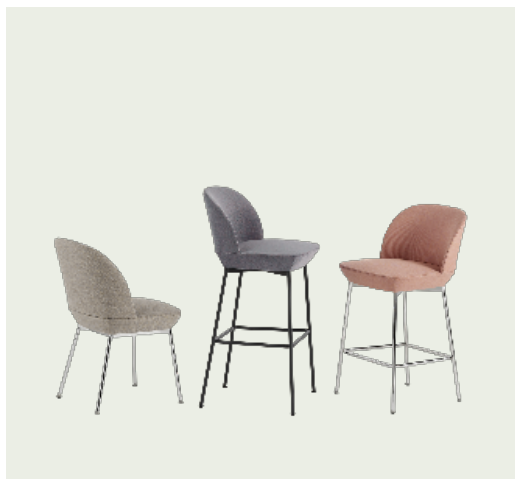

OSLO CHAIR

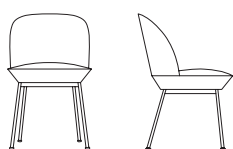

80,5 cm / 31.7"
SH 45 cm / 17.75"

51 cm / 20.08"

56 cm / 22.05"

OSLO COUNTER STOOL

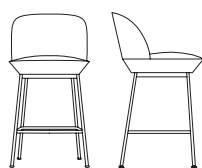

93,5 cm / 36.8"
SH 65 cm / 25.6"

51 cm / 20.1"

55 cm / 21.7"

OSLO BAR STOOL

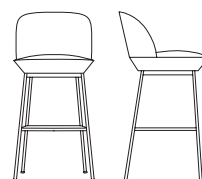

103,5 cm / 40.8"
SH 75 cm / 29.5"

51 cm / 20.1"

55 cm / 21.7"

All Variants

	Pattern No.	Upholstery Grades			
		A	B	C	E
Oslo Side Chair	M-OSLS-U	954	1,045	1,150	1,150
Oslo Counter Stool	M-OSLST-C-U	1,045	1,150	1,255	1,255
Oslo Bar Stool	M-OSLST-B-U	1,045	1,150	1,255	1,255

HOW TO CONFIGURE

Specify:

- Step 1: Choose variant
- Step 2: Choose base color
- Step 3: Choose textile
- Step 4: Choose textile color

ORDER CODE EXAMPLE:

Oslo Side Chair in Steelcut Trio 226 w/chrome base

Variant	Oslo Side Chair	MOSLSU
Base Color	Chrome	CHRO
Textile	Steelcut Trio	M139
Textile Color	226	226
Final Pattern No:	MOSLSUCHROM139226	

Base Finish Options

- BLCK - Anthracite Black
- CHRO - Chrome

Upholstery Options

A	B	C	E
Ocean (M161)*	Clara (M154) Fiord (M155) Grain (M12659) Manner (M12665) Re-Wool (M4586) Sabi (M8404) Steelcut (M149) Steelcut Trio (M139)	Hallingdal (M146)	Divina (M150) Divina MD (M147) Divina Melange (M135) Ecriture (M10767) Twill Weave (M142) Vidar (M158)

*Notes:
Ocean - Color 3, 21, 32, 50, 52, 80 & 601

OSLO LOUNGE SERIES

FOR MORE INFORMATION,
EXPLORE BELOW

- ↗ [Product Fact Sheet](#)
- ↗ [Images](#)
- ↗ [Architect Files](#)
- ↗ [Product Declaration](#)
- ↗ [Product Configurator](#)

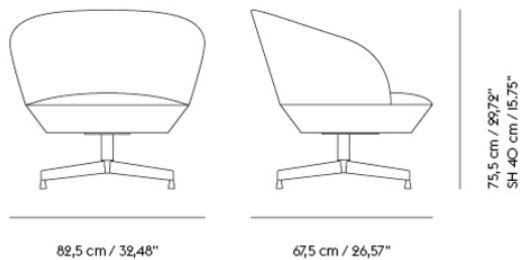

Shipper Colli	1
Gross Weight (kg)	23.5
Net Weight (kg)	21.5
Base color options	Black or Grey
Warranty period	10 years

Pattern No.	Color	Contract Price	Lead Time
-------------	-------	----------------	-----------

Ready-To-Ship US Warehouse

MOSLLCS-BLCK-M142990	Twill Weave 990/Black	USD 3,621.00	-
MOSLLCS-GREY-M158146	Vidar 146/Grey	USD 3,621.00	-

Extras

MGLDDLOFB4	Felt Glides for Doze Lounge Chair and Ottoman (4 pcs per pack)	USD 21.00	-
MLEAKIT	Leather care set for Refine Leather	USD 27.00	-

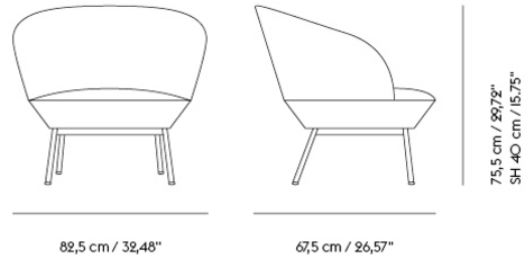

Shipper Colli	1
Gross Weight (kg)	23.5
Net Weight (kg)	21.5
Base color options	Black or Grey
Warranty period	10 years

Pattern No.	Color	Contract Price	Lead Time
Ready-To-Ship US Warehouse			
MOSLLCT-BLCK-M142990	Twill Weave 990/Black	USD 2,935.00	-
MOSLLCT-GREY-M158146	Vidar 146/Grey	USD 2,935.00	-
Extras			
MGLDDLOFB4	Felt Glides for Doze Lounge Chair and Ottoman (4 pcs per pack)	USD 21.00	-
MLEAKIT	Leather care set for Refine Leather	USD 27.00	-

OSLO LOUNGE CHAIR



All Upholstery Variants

All Variants

	Pattern No.	Upholstery Grades							
		COM				CIL			
		B	C	E	R	T	U	V	W
Oslo Lounge Chair Tube Base	MOSLLCT	2,571	2,676	2,935	3,096	3,516	3,565	4,090	4,146
Oslo Lounge Chair Swivel Base	MOSLLCS	2,935	3,096	3,621	3,775	4,090	4,146	4,510	4,566

HOW TO CONFIGURE

Specify:

- Step 1: Choose variant
- Step 2: Choose base color
- Step 3: Choose textile
- Step 4: Choose textile color

ORDER CODE EXAMPLE

Oslo Lounge Chair Tube Base in Divina 135

Variant	Oslo Lounge Chair Tube base	MOSLLCT
Base Color	Black	BLCK
Textile	Divina	M150
Textile Color	135	135
Final Pattern No:	MOSLLCTBLCKM150135	

Base Finish Options

- BLCK - Black
- GREY - Grey

Upholstery Options

B	C	E	R	T	U	V	W
Beck (M6376) Canvas (M153) Clara (M154) Fiord (M155) Grain (M12659) Manner (M12665) Re-Wool (M4586) Sabi (M8404) Steelcut (M149) Steelcut Trio (M139)	Hallingdal (M146)	Acca (M12660) Divina (M150) Divina MD (M147) Divina Melange (M135) Hearth (M12664) Twill Weave (M142) Vidar (M158)	Easy Leather (M141)	Refine Leather (M136)	Endure Leather (M137)	Grace Leather (M12374)	Allure Leather (M12375)

OSLO SOFA SERIES

FOR MORE INFORMATION,
EXPLORE BELOW

- ↗ [Product Fact Sheet](#)
- ↗ [Images](#)
- ↗ [Architect Files](#)
- ↗ [Assembly Instructions](#)
- ↗ [Product Declaration](#)
- ↗ [Product Configurator](#)

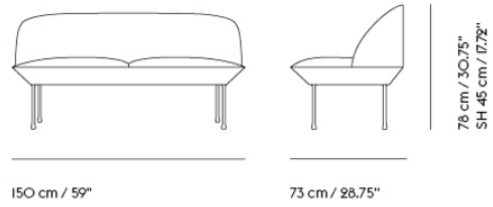

Shipper Colli	1
Gross Weight (kg)	34
Net Weight (kg)	31
Base color options	Black, Chrome, Dark Grey or Grey
Warranty Period	10 years

Pattern No.	Color	Contract Price	Lead Time
Ready-To-Ship US Warehouse			
MOSLSF2-NABL-M158554	Vidar 554/Navy Blue ***	USD 4,615.00	-
Extras			
MLEAKIT	Leather care set for Refine Leather	USD 27.00	-

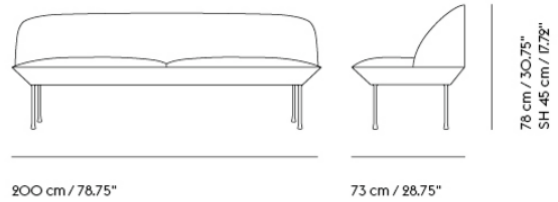

Shipper Colli	1
Gross Weight (kg)	49
Net Weight (kg)	44
Base color options	Black, Chrome, Dark Grey or Grey
Warranty Period	10 years

Pattern No.	Color	Contract Price	Lead Time
Ready-To-Ship US Warehouse			
MOSLSF3-DKGY-M149180	Steelcut 180/Dark Grey ***	USD 4,615.00	-
MOSLSF3-DKGY-M139966	Steelcut Trio 966/Dark Grey	USD 4,615.00	-
MOSLSF3-NABL-M158554	Vidar 554/Navy Blue ***	USD 5,406.00	-
Extras			
MLEAKIT	Leather care set for Refine Leather	USD 27.00	-

OSLO SOFA SERIES



OSLO SOFA 3-SEATER

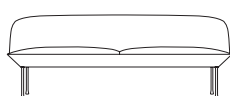

200 cm / 78.75"



73 cm / 28.75"

OSLO SOFA 2-SEATER

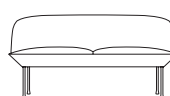

150 cm / 59"



73 cm / 28.75"

78 cm / 30.75"
SH 45 cm / 17.75"

OSLO SOFA 1-SEATER



80 cm / 31.5"



73 cm / 28.75"

78 cm / 30.75"
SH 45 cm / 17.75"

OSLO BENCH

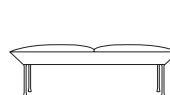

150 cm / 59"



73 cm / 28.75"

Oslo Pouf:
Shipper colli 1
Gross Weight (kg) 17
Net Weight (kg) 16
Warranty Period 10 years

Oslo 1-Seater:
Shipper colli 1
Gross Weight (kg) 23
Net Weight (kg) 20
Warranty Period 10 years

Oslo Sofa 3-Seater:
Shipper colli: 1
Gross Weight (kg) 46
Net Weight (kg) 44
Warranty Period 10 years

OSLO POUF

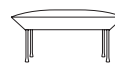

100 cm / 39.5"



73 cm / 28.75"

45 cm / 17.75"

Oslo Bench:
Shipper colli: 1
Gross Weight (kg) 34
Net Weight (kg) 32
Warranty Period 10 years

Oslo Sofa 2-Seater:
Shipper colli: 1
Gross Weight (kg) 34
Net Weight (kg) 32
Warranty Period 10 years

All Variants

	Pattern No.	Upholstery Grades								
		A	B	C	E	R	T	U	V	W
Oslo Sofa 2-seater	M-OSLSF-2	3,565	4,090	4,300	4,615	4,776	5,140	5,245	5,721	5,770
Oslo Sofa 3-seater	M-OSLSF-3	4,300	4,615	4,986	5,406	5,616	5,980	6,036	6,561	6,771
Oslo 1-Seater	M-OSLSF-1	2,305	2,515	2,676	2,935	3,096	3,516	3,565	4,090	4,146
Oslo Bench	M-OSLB	2,361	2,571	2,830	3,040	3,096	3,411	3,516	3,726	3,831
Oslo Pouf	M-OSLP	1,836	1,941	2,256	2,305	2,361	2,781	2,830	3,040	3,096

HOW TO CONFIGURE

Specify:

Step 1: Choose variant
Step 2: Choose base color
Step 3: Choose textile
Step 4: Choose textile color

ORDER CODE EXAMPLE:

Oslo 2-seater in Steelcut Trio 226 w/chrome base

Variant	Oslo 2-seater	MOSLSF2
Base Color	Chrome	CHRO
Textile	Steelcut Trio	M139
Textile Color	226	226
Final Pattern No:	MOSLSF2CHROM139226	

Base Finish Options

BLCK - Black
CHRO - Chrome
DKGY - Dark Grey
GREY - Grey

Upholstery Options

A	B	C	E	R	T	U	V	W
Ocean (M161)*	Beck (M6376) Canvas (M153) Clara (M154) Fiord (M155) Grain (M12659) Manner (M12665) Re-Wool (M4586) Sabi (M8404) Steelcut (M149) Steelcut Trio (M139)	Hallingdal (M146)	Acca (M12660) Divina (M150) Divina MD (M147) Divina Melange (M135) Hearth (M12664) Twill Weave (M142) Vidar (M158)	Easy Leather (M141)	Refine Leather (M136)	Endure Leather (M137)	Grace Leather (M12374)	Allure Leather (M12375)

*Notes:
Ocean - Color 3, 21, 32, 50, 52, 80 & 601

OUTLINE SOFA SERIES

FOR MORE INFORMATION,
EXPLORE BELOW

- ↗ [Product Fact Sheet](#)
- ↗ [Images](#)
- ↗ [Architect Files](#)
- ↗ [Assembly Instructions](#)
- ↗ [Product Declaration](#)
- ↗ [Product Configurator](#)

The Outline Sofa Family adds new perspectives to the classic Scandinavian design sofas of the 1960's, marrying the ideals of simplicity and function into one. With the design taking its name from its strong outline of a sofa, the Outline family is clean and elegant on the outside with a deep seat and soft cushioning on its inside.

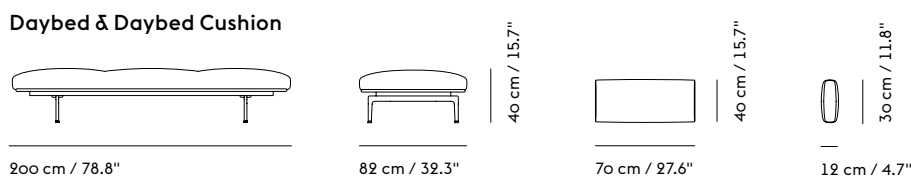
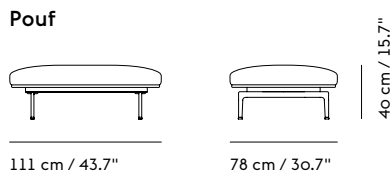
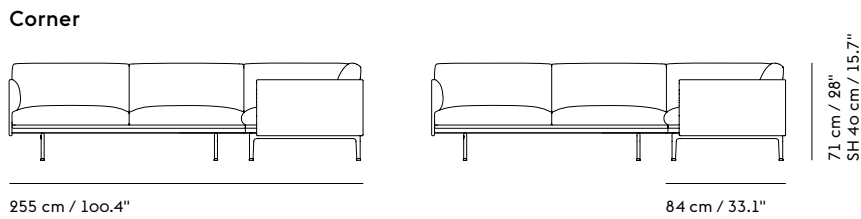
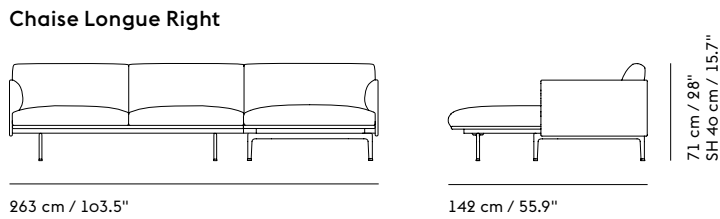
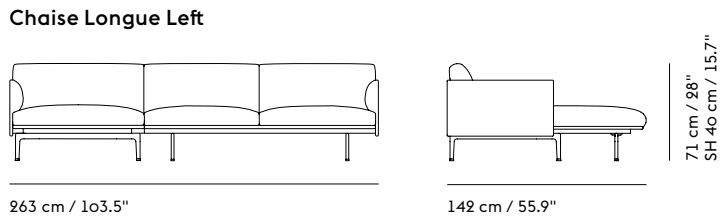
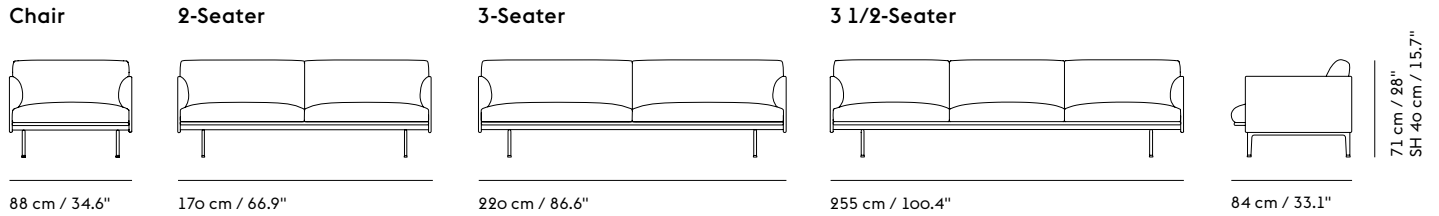

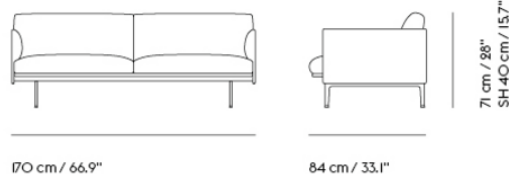

Shipper Colli 1
Gross Weight (kg) 55
Net Weight (kg) 50
Warranty Period 10 years

Pattern No.	Color	Contract Price	Lead Time
Ready-To-Ship US Warehouse			
MOUSF2-BLCK-M156163	Remix I63/Black	USD 4,405.00	-
MOUSF2-BLCK-K23401	Attire I/Black ***	USD 5,140.00	-
MOUSF2-BLCK-M136COGN	Refine Leather Cognac/Black	USD 7,240.00	-
Extras			
MLEAKIT	Leather care set for Refine Leather	USD 27.00	-
MPWROUT	Power Outlet - Black	USD 572.00	-

OUTLINE SOFA / 2-SEATER - POLISHED ALUMINUM BASE

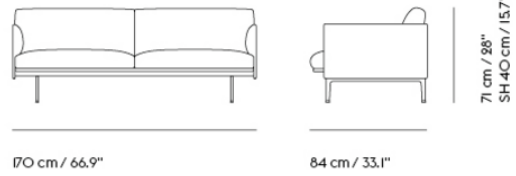

Shipper Colli 1
Gross Weight (kg) 55
Net Weight (kg) 50
Warranty Period 10 years

Pattern No.	Color	Contract Price	Lead Time
Ready-To-Ship US Warehouse			
MOUTSF2-ALU-M150984	Divina 984/Polished Aluminum ***	USD 5,875.00	-
Ready-To-Ship EU Warehouse			
MOUTSF2-ALU-M10767240	Ecriture 240/Polished Aluminum	USD 5,875.00	-
Extras			
MLEAKIT	Leather care set for Refine Leather	USD 27.00	-
MPWR0UT	Power Outlet - Black	USD 572.00	-

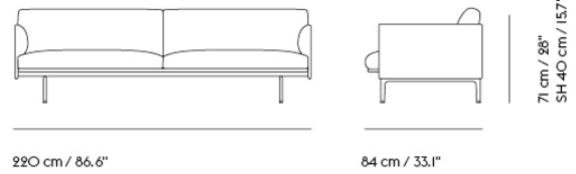

Shipper Colli 1
 Gross Weight (kg) 74
 Net Weight (kg) 69
 Warranty Period 10 years

Pattern No.	Color	Contract Price	Lead Time
Ready-To-Ship US Warehouse			
MOUTSF3-BLCK-M156163	Remix I63/Black	USD 4,825.00	-
MOUTSF3-BLCK-K23401	Attire I/Black ***	USD 5,721.00	-
MOUTSF3-BLCK-M136COGN	Refine Leather Cognac/Black	USD 8,031.00	-
Extras			
MLEAKIT	Leather care set for Refine Leather	USD 27.00	-
MPWROUT	Power Outlet - Black	USD 572.00	-

OUTLINE SOFA / 3-SEATER - POLISHED ALUMINUM BASE

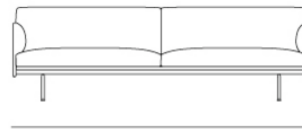

220 cm / 86.6"

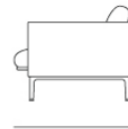

84 cm / 33.1"

71 cm / 28"
SH 40 cm / 15.7"

Shipper Colli	1
Gross Weight (kg)	74
Net Weight (kg)	69
Warranty Period	10 years

Pattern No.	Color	Contract Price	Lead Time
Ready-To-Ship US Warehouse			
MOUTSF3-ALU-M150984	Divina 984/Polished Aluminum ***	USD 6,561.00	-
Ready-To-Ship EU Warehouse			
MOUTSF3-ALU-M10767240	Ecriture 240/Polished Aluminum	USD 6,561.00	-
Extras			
MLEAKIT	Leather care set for Refine Leather	USD 27.00	-
MPWR0UT	Power Outlet - Black	USD 572.00	-

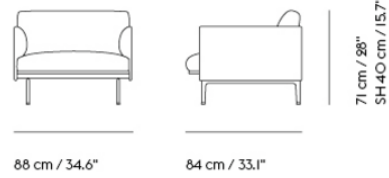

Shipper Colli |
 Gross Weight (kg) 35
 Net Weight (kg) 30
 Warranty Period 10 years

Pattern No.	Color	Contract Price	Lead Time
Ready-To-Ship US Warehouse			
MOUTC-BLCK-M156163	Remix I63/Black	USD 3,096.00	-
MOUTC-BLCK-K23401	Attire I/Black ***	USD 3,516.00	-
MOUTC-BLCK-M136COGN	Refine Leather Cognac/Black	USD 4,671.00	-
Extras			
MLEAKIT	Leather care set for Refine Leather	USD 27.00	-
MPWROUT	Power Outlet - Black	USD 572.00	-

OUTLINE CHAIR / POLISHED ALUMINUM BASE

347

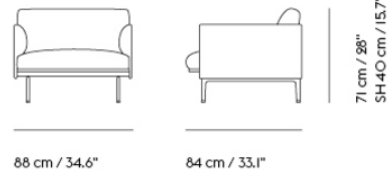

Shipper Colli 1
Gross Weight (kg) 35
Net Weight (kg) 30
Warranty Period 10 years

Pattern No.	Color	Contract Price	Lead Time
Ready-To-Ship US Warehouse			
MOUTC-ALU-M150984	Divina 984/Polished Aluminum ***	USD 4,041.00	-
Ready-To-Ship EU Warehouse			
MOUTC-ALU-M10767240	Ecriture 240/Polished Aluminum	USD 4,041.00	-
Extras			
MLEAKIT	Leather care set for Refine Leather	USD 27.00	-
MPWR0UT	Power Outlet - Black	USD 572.00	-

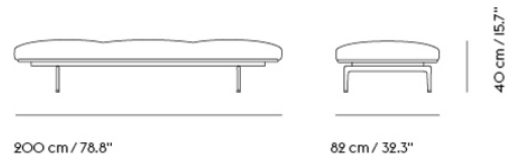
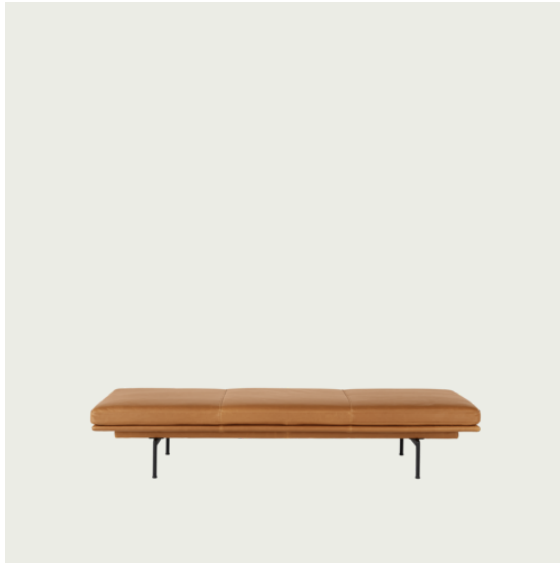

Shipper Colli 1
Gross Weight (kg) 50
Net Weight (kg) 40
Warranty Period 5 years

Pattern No.	Color	Contract Price	Lead Time
Ready-To-Ship EU Warehouse			
MOUJD-BLCK-M136COGN	Refine Leather Cognac/Black	USD 5,350.00	-
Extras			
MLEAKIT	Leather care set for Refine Leather	USD 27.00	-
MPWROUT	Power Outlet - Black	USD 572.00	-



Shipper Colli 1
 Gross Weight (kg) 4
 Net Weight (kg) 1.35
 Warranty Period 5 years

Pattern No.	Color	Contract Price	Lead Time
Ready-To-Ship EU Warehouse			
MOUTDC-M136COGN	Refine Leather Cognac	USD 629.00	-
Extras			
MLEAKIT	Leather care set for Refine Leather	USD 27.00	-



All Variants

	Pattern No.	Base Color	Upholstery Grades									
			A	B	C	E	G	R	T	U	V	W
Outline Chair	M-OUT-C-BLCK	black	3,096	3,516	3,621	3,775	4,090	4,146	4,671	5,616	5,721	6,085
	M-OUT-C-ALU	aluminum	3,355	3,775	3,880	4,041	4,356	4,405	4,986	5,875	5,980	6,351
Outline 2-seater	M-OUT-SF-2-BLCK	black	4,405	5,140	5,406	5,616	5,875	6,876	7,240	8,920	9,081	9,816
	M-OUT-SF-2-ALU	aluminum	4,671	5,406	5,721	5,875	6,141	7,191	7,506	9,186	9,340	10,131
Outline 3-seater	M-OUT-SF-3-BLCK	black	4,825	5,721	5,980	6,295	6,561	7,450	8,031	10,180	10,446	11,545
	M-OUT-SF-3-ALU	aluminum	5,091	5,980	6,246	6,561	6,820	7,765	8,290	10,446	11,020	11,545
Outline 3.5-seater	M-OUT-SF-35-BLCK	black	5,511	6,141	6,876	7,030	7,296	8,920	9,340	12,070	12,070	12,595
	M-OUT-SF-35-ALU	aluminum	5,770	6,456	7,191	7,296	7,555	9,186	9,606	12,595	12,595	13,120
Outline Daybed	M-OUT-D-BLCK	black	3,306	3,775	4,041	4,090	4,356	4,405	5,350	5,980	6,141	6,351
	M-OUT-D-ALU	aluminum	3,565	4,041	4,300	4,356	4,615	4,671	5,616	6,246	6,456	6,610
Outline Daybed cushion	M-OUT-DC		450	520	576	597	614	614	629	719	776	807

HOW TO CONFIGURE

- Specify:
- Step 1) Choose Variant + base color
 - Step 2) Upholstery option
 - Step 3) Upholstery color

ORDER CODE EXAMPLE:

Outline 2-seater sofa in Ocean 80 w/black base

Variant + base color Outline 2-seater sofa MOUTSF2-BLCK
 Upholstery option Ocean M161
 Upholstery Color 80
 Final Pattern No: MOUTSF2BLCKM16180

Base Finish Options

- BLCK - Black
- ALU - Aluminum

Upholstery Options

A	B	C	E	G	R	T	U	V	W
Mode (M2319) Ocean (M161)* Remix (M156)	Beck (M6376) Cameo (K1443) Canvas (M153) Clara (M154) Fiord (M155) Grain (M12659) Manner (M12665) Pebble Weave (M6374) ** Pecora (M6372) *** Prairie (K1925)* Steelcut (M149) Steelcut Trio (M139) Steelcut Quartet (M13042)	Chameleon (K2372) Color Field (K2226) Hallingdal (M146)	Acca (M12660) Aegean (K2074) Balder (M152) Divina (M150) Divina MD (M147) Divina Melange (M135) Ecriture (M10767) Hearth (M12664) Premiere (K2294) Twill Weave (M142) Vidar (M158)	Modern Tweed (K2155)	Easy Leather (M141)	Refine Leather (M136)	Endure Leather (M137)	Grace Leather (M12374)	Allure Leather (M12375)

*Notes:
 *Ocean: Color 3, 21, 32, 50, 52, 80 & 601
 Pebble Weave: Color 3, 7, 8, 11, 12, 21
 Pecora: Color 6049, 6083, 6084, 6093, 60112
 *Prairie: All Additive Free (ADF) Colors

OUTLINE SOFA SERIES – 2/2

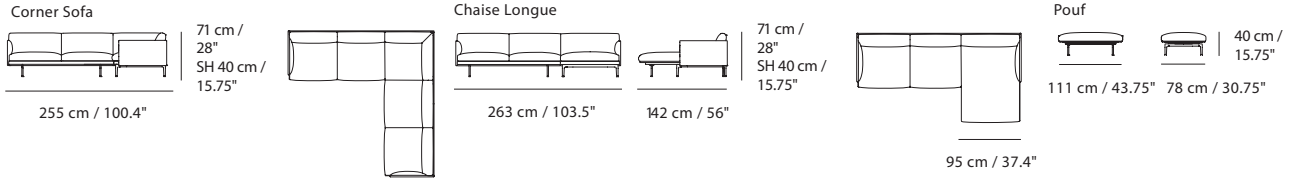

Outline Corner:
 Shipper Colli 2
 Gross Weight (kg) 122
 Net Weight (kg) 112
 Warranty Period 10 years

Outline Chaise Longue:
 Shipper Colli 2
 Gross Weight (kg) 90
 Net Weight (kg) 80
 Directional modules Right and left refers to the side when facing the product from the front.
 Warranty Period 10 years

Outline Pouf:
 Shipper Colli 1
 Gross Weight (kg) 23
 Net Weight (kg) 17
 Warranty Period 10 years

All Variants

	Pattern No.	Base Color	Upholstery Grades									
			A	B	C	E	G	R	T	U	V	W
Outline Corner sofa	M-OUT-CS-BLCK	black	8,556	9,970	11,020	11,545	11,545	14,170	15,745	18,895	20,995	22,045
	M-OUT-CS-ALU	aluminum	9,081	10,495	11,545	12,070	12,070	14,695	16,270	19,420	21,520	23,095
Outline Chaise lounge - left	M-OUT-CL-L-BLCK	black	7,030	7,555	8,500	8,920	9,340	10,446	11,020	13,645	14,695	16,270
	M-OUT-CL-L-ALU	aluminum	7,450	7,975	8,920	9,291	9,760	11,020	11,545	14,170	15,745	16,270
Outline Chaise lounge - right	M-OUT-CL-R-BLCK	black	7,030	7,555	8,500	8,920	9,340	10,446	11,020	13,645	14,695	16,270
	M-OUT-CL-R-ALU	aluminum	7,450	7,975	8,920	9,291	9,760	11,020	11,545	14,170	15,745	16,270
Outline Pouf	M-OUT-P-BLCK	black	1,570	1,836	2,095	2,515	2,571	2,620	2,571	3,306	3,355	3,621
	M-OUT-P-ALU	aluminum	1,836	2,095	2,361	2,781	2,830	2,886	2,830	3,565	3,621	3,880

HOW TO CONFIGURE

Specify:

- Step 1) Choose Variant + base color
- Step 2) Upholstery option
- Step 3) Upholstery color

ORDER CODE EXAMPLE:

Outline 2-seater sofa in Ocean 80 w/black base

Variant + base color	Outline 2-seater sofa	MOUTSF2-BLCK
Upholstery option	Ocean	M161
Upholstery Color	80	80
Final Pattern No:	MOUTSF2BLCKM16180	

Base Finish Options

- BLCK - Black
- ALU - Aluminum

Upholstery Options

A	B	C	E	G	R	T	U	V	W
Mode (M2319) Ocean (M161)* Remix (M156)	Beck (M6376) Cameo (K1443) Canvas (M153) Clara (M154) Fiord (M155) Grain (M12659) Manner (M12665) Pebble Weave (M6374) ** Pecora (M6372) ** Prairie (K1925)* Steelcut (M149) Steelcut Trio (M139) Steelcut Quartet (M13042)	Chameleon (K2372) Color Field (K2226) Hallingdal (M146)	Acca (M12660) Aegean (K2074) Balder (M152) Divina (M150) Divina MD (M147) Divina Melange (M135) Ecriture (M10767) Hearth (M12664) Premiere (K2294) Twill Weave (M142) Vidar (M158)	Modern Tweed (K2155)	Easy Leather (M141)	Refine Leather (M136)	Endure Leather (M137)	Grace Leather (M12374)	Allure Leather (M12375)

*Notes:
 *Ocean: Color 3, 21, 32, 50, 52, 80 & 601
 Pebble Weave: Color 3, 7, 8, 11, 12, 21
 Pecora: Color 6049, 6083, 6084, 6093, 60112
 *Prairie: All Additive Free (ADF) Colors



140 cm / 55.1" - both heights:
 Shipper Colli 1
 Gross Weight (kg) 41
 Net Weight (kg) 36
 Warranty Period 10 years

170 cm / 66.9" - both heights:
 Shipper Colli 1
 Gross Weight (kg) 64
 Net Weight (kg) 50
 Warranty Period 10 years

220 cm / 86.6" - both heights:
 Shipper Colli 1
 Gross Weight (kg) 70
 Net Weight (kg) 66
 Warranty Period 10 years

All Variants

STUDIO SOFA 220 CM / 86.6"

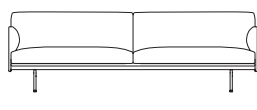

W 220 cm / 86.6"
 SW 200 cm / 78.7"



76 cm / 29.9"
 SD 54 cm / 21.3"

71 cm / 28"
 SH 40 cm / 15.7"

STUDIO SOFA 220 CM / 86.6" — SH 45 CM / 17.7"

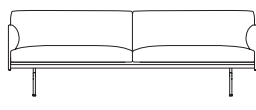

W 220 cm / 86.6"
 SW 200 cm / 78.7"



76 cm / 29.9"
 SD 54 cm / 21.3"

76 cm / 29.9"
 SH 45 cm / 17.7"

STUDIO SOFA 170CM / 66.9"

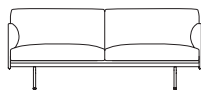

W 170 cm / 66.9"
 SW 150 / 59.1"



76 cm / 29.9"
 SD 54 cm / 21.3"

71 cm / 28"
 SH 40 cm / 15.7"

STUDIO SOFA 170CM / 66.9" — SH 45 CM / 17.7"

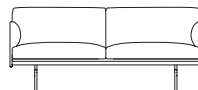

W 170 cm / 66.9"
 SW 150 / 59.1"



76 cm / 29.9"
 SD 54 cm / 21.3"

76 cm / 29.9"
 SH 45 cm / 17.7"

STUDIO SOFA 140 CM / 55.1"

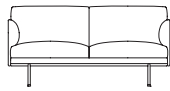

W 140 cm / 55.1"
 SW 120 cm / 47.2"



76 cm / 29.9"
 SD 54 cm / 21.3"

71 cm / 28"
 SH 40 cm / 15.75"

STUDIO 140 CM / 55.1" — SH 45 CM / 17.7"

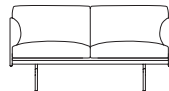

W 140 cm / 55.1"
 SW 120 cm / 47.2"



76 cm / 29.9"
 SD 54 cm / 21.3"

76 cm / 29.9"
 SH 45 cm / 17.7"

STUDIO CHAIR



W 78 cm / 30.7"
 SW 60 cm / 23.6"



76 cm / 29.9"
 SD 54 cm / 21.3"

STUDIO CHAIR — SH 45 CM / 17.7"



W 78 cm / 30.7"
 SW 60 cm / 23.6"



76 cm / 29.9"
 SD 54 cm / 21.3"

76 cm / 29.9"
 SH 45 cm / 17.7"

OUTLINE STUDIO SOFA SERIES

All Variants

Pattern No.	Seat Height	Base Color	Upholstery Grades									
			A	B	C	E	G	R	COL			
Outline Studio 140 cm / 55" Sofa												
M-OUT-SS-16-55-BLCK	15.75"	black	3,831	4,615	4,986	5,140	5,406	5,616	6,246	7,975	8,080	8,290
M-OUT-SS-18-55-BLCK	17.75"	black	3,831	4,615	4,986	5,140	5,406	5,616	6,246	7,975	8,080	8,290
M-OUT-SS-16-55-ALU	15.75"	aluminum	4,090	4,881	5,245	5,406	5,721	5,875	6,505	8,241	8,346	8,556
M-OUT-SS-18-55-ALU	17.75"	aluminum	4,090	4,881	5,245	5,406	5,721	5,875	6,505	8,241	8,346	8,556
Outline Studio 170 cm / 67" Sofa												
M-OUT-SS-16-67-BLCK	15.75"	black	4,090	4,671	5,091	5,350	5,511	6,295	7,240	8,500	8,661	9,291
M-OUT-SS-18-67-BLCK	17.75"	black	4,090	4,671	5,091	5,350	5,511	6,295	7,240	8,500	8,661	9,291
M-OUT-SS-16-67-ALU	15.75"	aluminum	4,356	4,986	5,350	5,616	5,770	6,561	7,506	8,766	8,920	9,550
M-OUT-SS-18-67-ALU	17.75"	aluminum	4,356	4,986	5,350	5,616	5,770	6,561	7,506	8,766	8,920	9,550
Outline Studio 220 cm / 86.5" Sofa												
M-OUT-SS-16-87-BLCK	15.75"	black	4,405	5,245	5,511	5,770	6,141	7,030	8,080	9,550	9,921	11,020
M-OUT-SS-18-87-BLCK	17.75"	black	4,405	5,245	5,511	5,770	6,141	7,030	8,080	9,550	9,921	11,020
M-OUT-SS-16-87-ALU	15.75"	aluminum	4,671	5,511	5,770	6,036	6,456	7,296	8,346	9,816	10,180	11,545
M-OUT-SS-18-87-ALU	17.75"	aluminum	4,671	5,511	5,770	6,036	6,456	7,296	8,346	9,816	10,180	11,545
Outline Studio Chair												
M-OUT-SC-16-BLCK	15.75"	black	2,620	3,096	3,516	3,565	3,775	4,090	4,300	5,140	5,350	5,721
M-OUT-SC-18-BLCK	17.75"	black	2,620	3,096	3,516	3,565	3,775	3,831	4,300	5,140	5,350	5,721
M-OUT-SC-16-ALU	15.75"	aluminum	2,886	3,355	3,775	3,831	4,041	4,146	4,566	5,406	5,616	5,980
M-OUT-SC-18-ALU	17.75"	aluminum	2,886	3,355	3,775	3,831	4,041	4,090	4,566	5,406	5,616	5,980

HOW TO CONFIGURE

ORDER CODE EXAMPLE:

Specify:

Outline Studio 140 cm Seat Height 15.75" w/black base in Ocean 80

- Step 1) Choose Variant + base color
- Step 2) Upholstery option
- Step 3) Upholstery color

Variant + base color Outline Studio 140 cm Seat Height 15.75" w/black base M-OUT-SS-16-55-BLCK
 Upholstery option Ocean M161
 Upholstery Color 80
 Final Pattern No: MOUTSF2BLCKM16180

Base Finish Options

- BLCK - Black
- ALU - Aluminum

Upholstery Options

A	B	C	E	G	R	T	U	V	W
Mode (M2319)	Beck (M6376)	Chameleon (K2372)	Acca (M12660)	Modern Tweed (K2155)	Easy Leather (M141)	Refine Leather (M136)	Endure Leather (M137)	Grace Leather (M12374)	Allure Leather (M12375)
Ocean (M161)*	Cameo (K1443)	Color Field (K2226)	Aegean (K2074)						
Remix (M156)	Canvas (M153)	Hallingdal (M146)	Balder (M152)						
	Clara (M154)		Divina (M150)						
	Fiord (M155)		Divina MD (M147)						
	Grain (M12659)		Divina Melange (M135)						
	Manner (M12665)		Ecriture (M10767)						
	Pebble Weave (M6374) **		Hearth (M12664)						
	Pecora (M6372) **		Premiere (K2294)						
	Prairie (K1925)*		Twill Weave (M142)						
	Steelcut (M149)		Vidar (M158)						
	Steelcut Trio (M139)								
	Steelcut Quartet (M13042)								

*Notes:
 *Ocean: Color 3, 21, 32, 50, 52, 80 & 601
 Pebble Weave: Color 3, 7, 8, 11, 12, 21
 Pecora: Color 6049, 6083, 6084, 6093, 60112
 *Prairie: All Additive Free (ADF) Colors

OUTLINE HIGHBACK SOFA SERIES

FOR MORE INFORMATION,
EXPLORE BELOW

- ↗ [Product Fact Sheet](#)
- ↗ [Images](#)
- ↗ [Architect Files](#)
- ↗ [Assembly Instructions](#)
- ↗ [Product Declaration](#)
- ↗ [Product Configurator](#)

The Outline Sofa Family adds new perspectives to the classic Scandinavian design sofas of the 1960's, marrying the ideals of simplicity and function into one. With the design taking its name from its strong outline of a sofa, the Outline family is clean and elegant on the outside with a deep seat and soft cushioning on its inside.

Highback 100 (Also available with SH: 45 cm / 17.7")

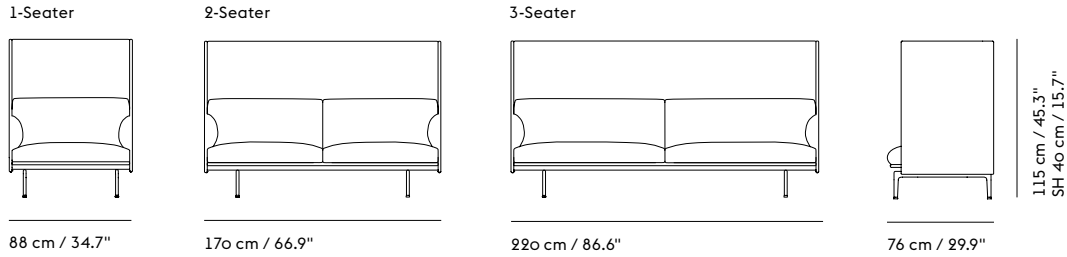

Highback 120 (Also available with SH: 45 cm / 17.7")

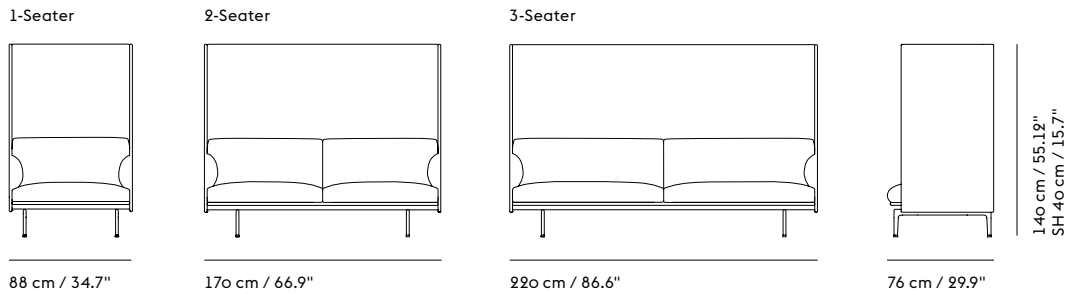

Highback Work 100 (Also available with SH: 45 cm / 17.7")

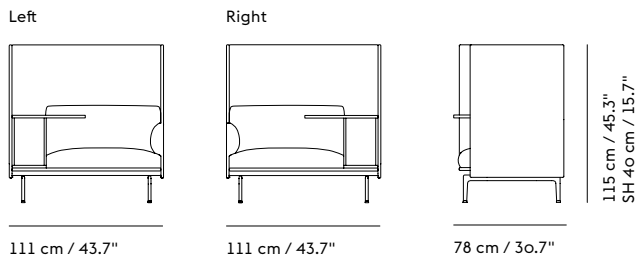

Highback Work 120 (Also available with SH: 45 cm / 17.7")

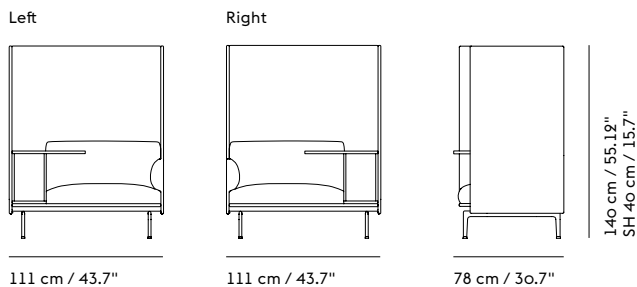

Highback Cabin 100 (Also available with SH: 45 cm / 17.7")

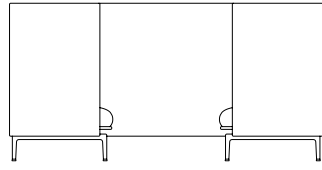

231 cm / 90.94"

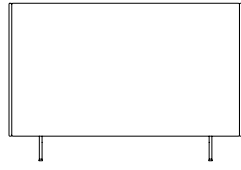

170 cm / 66.9"

115 cm / 45.3"
SH 40 cm / 15.7"

2-Seater

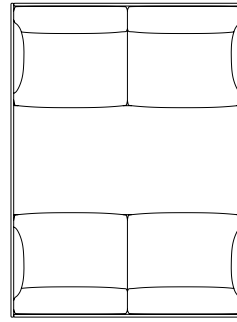

170 cm / 66.9"

3-Seater

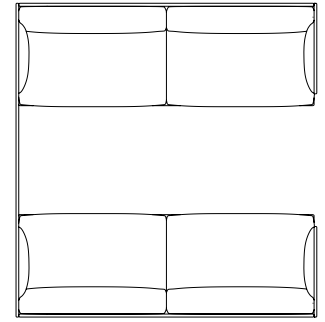

220 cm / 86.6"

Highback Cabin 120 (Also available with SH: 45 cm / 17.7")

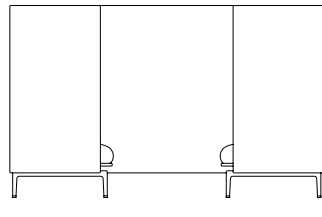

231 cm / 90.94"

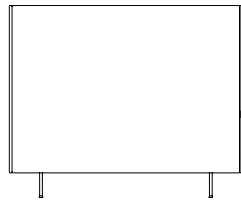

170 cm / 66.9"

140 cm / 55.12"
SH 40 cm / 15.7"

2-Seater

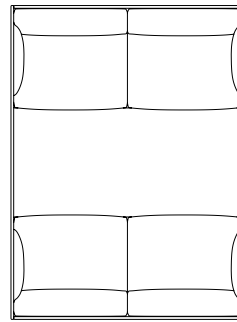

170 cm / 66.9"

3-Seater

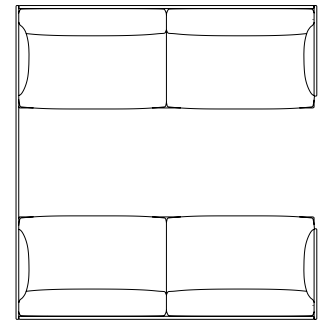

220 cm / 86.6"

Highback Cabin 100 w/ Table—SH45 cm

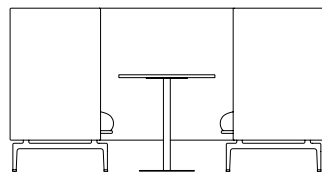

231 cm / 90.94"
Table W 70cm / 27.56"

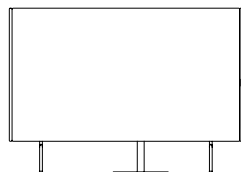

170 cm / 66.9"

120 cm / 47.3"
SH 45 cm / 17.7"

Table H 71 cm / 27.95"

2-Seater

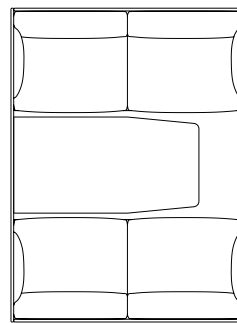

170 cm / 66.9"

Highback Cabin 120 w/ Table—SH45 cm

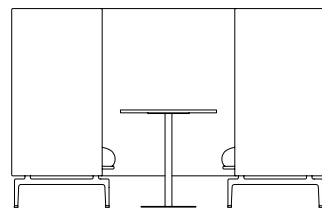

231 cm / 90.94"
Table W 70cm / 27.56"

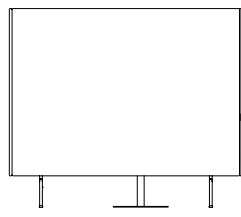

170 cm / 66.9"

145 cm / 57.09"
SH 45 cm / 17.7"

Table H 71 cm / 27.95"

2-Seater

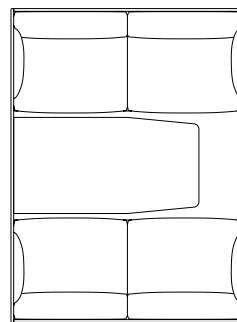

170 cm / 66.9"

OUTLINE HIGHBACK SOFA 100 / 1-SEATER - BLACK BASE

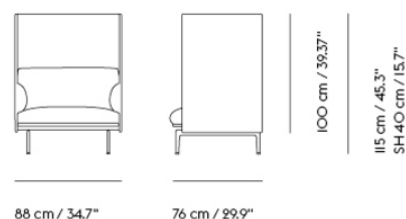

Shipper Colli	1
Gross Weight (kg)	63
Net Weight (kg)	54
Additional Information	Please note that the highback height for this product is 100 cm / 39.4"
Warranty Period	10 years

Pattern No.	Color	Contract Price	Lead Time
Ready-To-Ship US Warehouse			
MOUTHBSF116-BLCK-M156163	Remix I63/Black	USD 4,090.00	-
MOUTHBSF116-BLCK-K23401	Attire I/Black ***	USD 4,671.00	-
Extras			
MLEAKIT	Leather care set for Refine Leather	USD 27.00	-
MPWR0UT	Power Outlet - Black	USD 572.00	-

OUTLINE HIGHBACK SOFA 100 / 1-SEATER - POLISHED ALUMINUM BASE

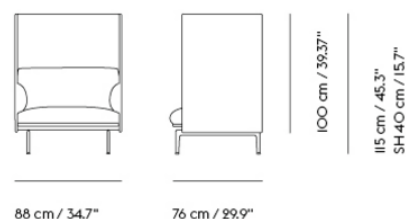

Shipper Colli	1
Gross Weight (kg)	63
Net Weight (kg)	54
Additional Information	Please note that the highback height for this product is 100 cm / 39.4"
Warranty Period	10 years

Pattern No.	Color	Contract Price	Lead Time
Ready-To-Ship US Warehouse			
MOUTHBSF116-ALU-M150984	Divina 984/Polished Aluminum	USD 5,616.00	-
Extras			
MLEAKIT	Leather care set for Refine Leather	USD 27.00	-
MPWROUT	Power Outlet - Black	USD 572.00	-

OUTLINE HIGHBACK SOFA 100 / 2-SEATER - BLACK BASE

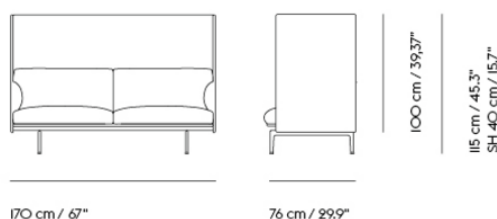

Shipper Colli	1
Gross Weight (kg)	71.6
Net Weight (kg)	71.6
Additional Information	Please note that the highback height for this product is 100 cm / 39.4"
Warranty Period	10 years

Pattern No.	Color	Contract Price	Lead Time
Ready-To-Ship US Warehouse			
MOUTHBSF216-BLCK-M156163	Remix 163/Black	USD 5,511.00	-
MOUTHBSF216-BLCK-K23401	Attire 1/Black ***	USD 6,141.00	-
Extras			
MLEAKIT	Leather care set for Refine Leather	USD 27.00	-
MPWR0UT	Power Outlet - Black	USD 572.00	-

OUTLINE HIGHBACK SOFA 100 / 2-SEATER - POLISHED ALUMINUM BASE

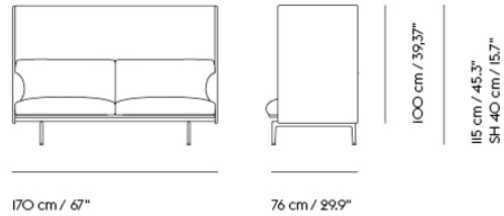

Shipper Colli	1
Gross Weight (kg)	85.84
Net Weight (kg)	71.6
Additional Information	Please note that the highback height for this product is 100 cm / 39.4"
Warranty Period	10 years

Pattern No.	Color	Contract Price	Lead Time
Ready-To-Ship US Warehouse			
MOUTHBSF216-ALU-M150984	Divina 984/Polished Aluminum	USD 7,296.00	-
Extras			
MLEAKIT	Leather care set for Refine Leather	USD 27.00	-
MPWROUT	Power Outlet - Black	USD 572.00	-

**OUTLINE HIGHBACK WORK 100 / LEFT -
POLISHED ALUMINUM BASE**

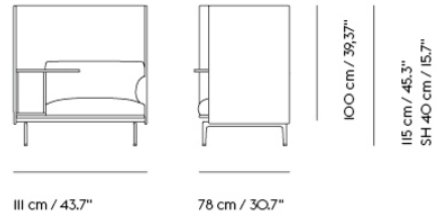

- Shipper Colli 1
- Gross Weight (kg) 83
- Net Weight (kg) 74
- Please note That this product features a table on the left-hand side when facing the product from the front.
- Warranty Period 5 years

Pattern No.	Color	Contract Price	Lead Time
Ready-To-Ship US Warehouse			
MOUTHBW16L-ALU-M150984	Divina 984/Polished Aluminum ***	USD 7,506.00	-
Extras			
MLEAKIT	Leather care set for Refine Leather	USD 27.00	-
MPWROUT	Power Outlet - Black	USD 572.00	-

OUTLINE HIGHBACK WORK 100 / LEFT - BLACK BASE

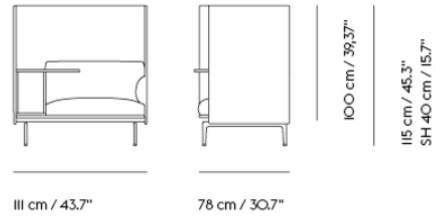

- Shipper Colli 1
- Gross Weight (kg) 83
- Net Weight (kg) 74
- Please note That this product features a table on the left-hand side when facing the product from the front.
- Warranty Period 5 years

Pattern No.	Color	Contract Price	Lead Time
Ready-To-Ship US Warehouse			
MOUTHBW16L-BLCK-M156163	Remix I63/Black	USD 5,980.00	-
Extras			
MLEAKIT	Leather care set for Refine Leather	USD 27.00	-
MPWROUT	Power Outlet - Black	USD 572.00	-

OUTLINE HIGHBACK WORK 100 / RIGHT - BLACK BASE

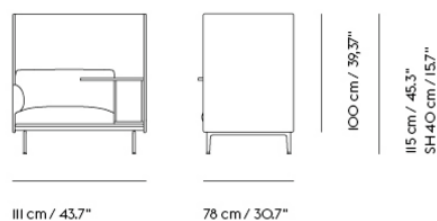

Shipper Colli	1
Gross Weight (kg)	83
Net Weight (kg)	74
Please note	That this product features a table on the right-hand side when facing the product from the front.
Warranty Period	5 years

Pattern No.	Color	Contract Price	Lead Time
Ready-To-Ship US Warehouse			
MOUTHBW16R-BLCK-M156163	Remix 163/Black	USD 5,980.00	-
Extras			
MLEAKIT	Leather care set for Refine Leather	USD 27.00	-
MPWROUT	Power Outlet - Black	USD 572.00	-

**OUTLINE HIGHBACK WORK 100 / RIGHT
- POLISHED ALUMINUM BASE**

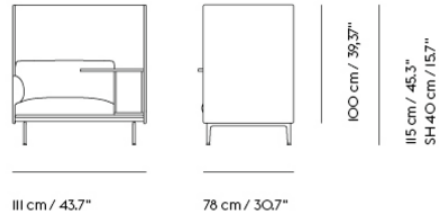

- Shipper Colli 1
- Gross Weight (kg) 83
- Net Weight (kg) 74
- Please note That this product features a table on the right-hand side when facing the product from the front.
- Warranty Period 5 years

Pattern No.	Color	Contract Price	Lead Time
Ready-To-Ship US Warehouse			
MOUTHBW16R-ALU-M150984	Divina 984/Polished Aluminum	USD 7,506.00	-
Extras			
MLEAKIT	Leather care set for Refine Leather	USD 27.00	-
MPWROUT	Power Outlet - Black	USD 572.00	-



Highback Sofa 120 1-seater
 Shipper Colli: 1
 Gross Weight (kg): 35
 Net Weight (kg): 25
 Warranty Period: 10 years

Highback Sofa 120 2-seater
 Shipper Colli: 1
 Gross Weight (kg): 54
 Net Weight (kg): 38
 Warranty Period: 10 years

Highback Work 120
 Shipper Colli: 1
 Gross Weight (kg): 38
 Net Weight (kg): 28
 Warranty Period: 5 years

All Variants

HIGHBACK 3-SEATER 120CM

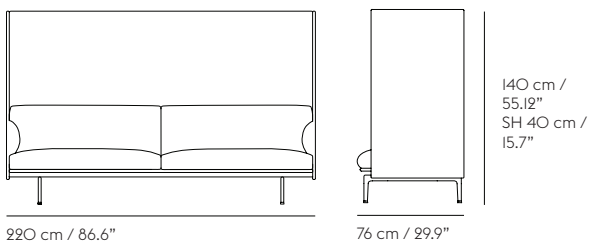

HIGHBACK 3-SEATER 120CM - SH 45CM

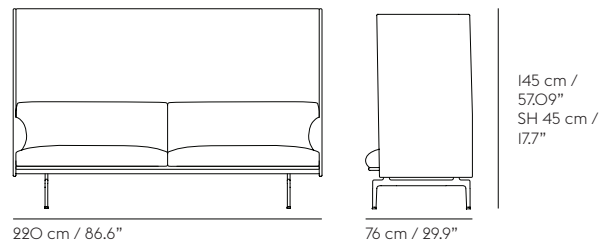

HIGHBACK 2-SEATER 120CM

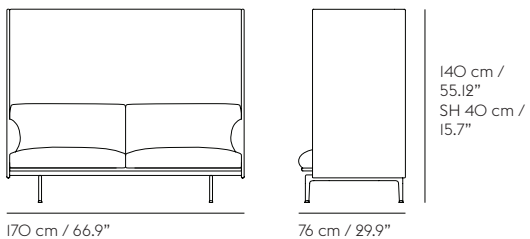

HIGHBACK 2-SEATER 120CM - SH 45CM

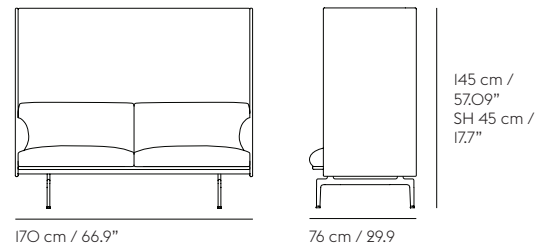

HIGHBACK WORK 120CM - RIGHT

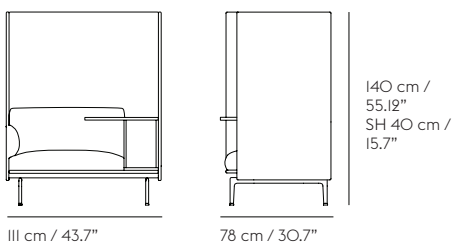

HIGHBACK WORK 120CM - SH 45CM - RIGHT

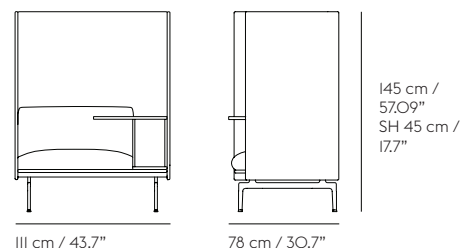

HIGHBACK 1-SEATER 120CM

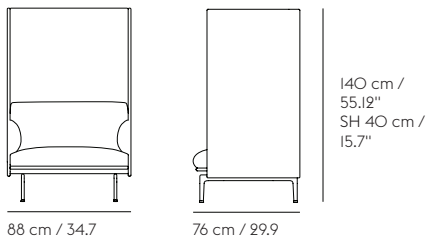

HIGHBACK 1-SEATER 120CM - SH 45CM

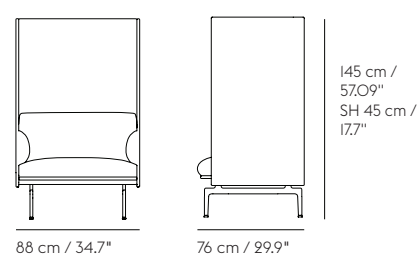

OUTLINE HIGHBACK I-SEATER & WORK

All Variants

				Upholstery Grades									
				COM		CIL			COL				
Pattern No.				A	B	C	E	G	R	T	U	V	W
		Seat Height	Base Color										
Outline Highback 1-seater- 100cm	M-OUT-HBSF-1-16-BLCK	15.75"	black	4,090	4,671	5,091	5,350	5,511	6,295	7,240	8,500	8,661	8,920
	M-OUT-HBSF-1-18-BLCK	17.75"	black	4,090	4,671	5,091	5,350	5,511	6,295	7,240	8,500	8,661	8,920
	M-OUT-HBSF-1-16-ALU	15.75"	aluminum	4,356	4,986	5,350	5,616	5,770	6,561	7,506	8,766	8,920	9,186
	M-OUT-HBSF-1-18-ALU	17.75"	aluminum	4,356	4,986	5,350	5,616	5,770	6,561	7,506	8,766	8,920	9,186
Outline Highback 1-Seater - 120cm	M-OUT-HBSF-1-16-120-BLCK	15.75"	black	4,146	4,671	4,986	5,091	5,770	6,715	7,555	8,920	9,081	9,711
	M-OUT-HBSF-1-18-120-BLCK	17.75"	black	4,146	4,671	4,986	5,091	5,770	6,715	7,555	8,920	9,081	9,711
	M-OUT-HBSF-1-16-120-ALU	15.75"	aluminum	4,405	4,986	5,245	5,350	6,036	6,981	7,821	9,186	9,340	9,970
	M-OUT-HBSF-1-18-120-ALU	17.75"	aluminum	4,405	4,986	5,245	5,350	6,036	6,981	7,821	9,186	9,340	9,970
Outline Highback Work - Left - 100cm	M-OUT-HBW-16-L-BLCK	15.75"	black	5,980	6,561	7,030	7,240	7,506	9,186	10,446	11,545	11,545	12,070
	M-OUT-HBW-18-L-BLCK	17.75"	black	5,980	6,561	7,030	7,240	7,506	9,186	10,446	11,545	11,545	12,070
	M-OUT-HBW-16-L-ALU	15.75"	aluminum	6,246	6,820	7,296	7,506	7,765	9,445	11,020	12,070	12,070	12,595
	M-OUT-HBW-18-L-ALU	17.75"	aluminum	6,246	6,820	7,296	7,506	7,765	9,445	11,020	12,070	12,070	12,595
Outline Highback Work - Left - 120cm	M-OUT-HBW-16-L-120-BLCK	15.75"	black	6,246	6,820	7,191	7,296	8,451	9,081	10,075	12,070	12,070	12,595
	M-OUT-HBW-18-L-120-BLCK	17.75"	black	6,246	6,820	7,191	7,296	8,451	9,081	10,075	12,070	12,070	12,595
	M-OUT-HBW-16-L-120-ALU	15.75"	aluminum	6,505	7,086	7,450	7,555	8,710	9,340	10,341	12,070	12,595	13,120
	M-OUT-HBW-18-L-120-ALU	17.75"	aluminum	6,505	7,086	7,450	7,555	8,710	9,340	10,341	12,070	12,595	13,120
Outline Highback Work - Right - 100cm	M-OUT-HBW-16-R-BLCK	15.75"	black	5,980	6,561	7,030	7,240	7,506	9,186	10,446	11,545	11,545	12,070
	M-OUT-HBW-18-R-BLCK	17.75"	black	5,980	6,561	7,030	7,240	7,506	9,186	10,446	11,545	11,545	12,070
	M-OUT-HBW-16-R-ALU	15.75"	aluminum	6,246	6,820	7,296	7,506	7,765	9,445	11,020	12,070	12,070	12,595
	M-OUT-HBW-18-R-ALU	17.75"	aluminum	6,246	6,820	7,296	7,506	7,765	9,445	11,020	12,070	12,070	12,595
Outline Highback Work - Right - 120cm	M-OUT-HBW-16-R-120-BLCK	15.75"	black	6,246	6,715	7,191	7,296	8,451	9,081	10,075	12,070	12,070	12,595
	M-OUT-HBW-18-R-120-BLCK	17.75"	black	6,246	6,820	7,191	7,296	8,451	9,081	10,075	12,070	12,070	12,595
	M-OUT-HBW-16-R-120-ALU	15.75"	aluminum	6,505	7,086	7,450	7,555	8,710	9,340	10,341	12,070	12,595	13,120
	M-OUT-HBW-18-R-120-ALU	17.75"	aluminum	6,505	7,086	7,450	7,555	8,710	9,340	10,341	12,070	12,595	13,120

HOW TO CONFIGURE

ORDER CODE EXAMPLE:

Specify:

Outline Highback Sofa 2-seater H 15.75" in Ocean 80 w/black legs

SStep 1) Choose Variant + base color
 Step 2) Upholstery option
 Step 3) Upholstery color

Variant + base color 2-seater, 15.75" SH - black base M-OUT-HBSF-2-16-BLCK
 Upholstery option Ocean M161
 Upholstery Color 80 80
 Final Pattern No: MOUTHBSF216BLCKM16180

Base Finish Options

BLCK - Black
 ALU - Aluminum

Upholstery Options

A	B	C	E	G	R	T	U	V	W
Mode (M2319) Ocean (M161)* Remix (M156)	Beck (M6376) Cameo (K1443) Canvas (M153) Clara (M154) Fiord (M155) Grain (M12659) Manner (M12665) Pebble Weave (M6374) ** Pecora (M6372) ** Prairie (K1925)* Steelcut (M149) Steelcut Trio (M139) Steelcut Quartet (M13042)	Chameleon (K2372) Color Field (K2226) Hallingdal (M146)	Acca (M12660) Aegean (K2074) Balder (M152) Divina (M150) Divina MD (M147) Divina Melange (M135) Ecriture (M10767) Hearth (M12664) Premiere (K2294) Twill Weave (M142) Vidar (M158)	Modern Tweed (K2155)	Easy Leather (M141)	Refine Leather (M136)	Endure Leather (M137)	Grace Leather (M12374)	Allure Leather (M12375)

*Notes:
 *Ocean: Color 3, 21, 32, 50, 52, 80 & 601
 Pebble Weave: Color 3, 7, 8, 11, 12, 21
 Pecora: Color 6049, 6083, 6084, 6093, 60112
 *Prairie: All Additive Free (ADF) Colors



3-seater - both heights:

Shipper Colli	1
Gross Weight (kg)	75
Net Weight (kg)	69
Warranty Period	10 years

2-seater - both heights:

Shipper Colli	1
Gross Weight (kg)	70
Net Weight (kg)	66
Warranty Period	10 years

1-seater - both heights:

Shipper Colli	1
Gross Weight (kg)	63
Net Weight (kg)	54
Warranty Period	10 years

Outline Highback Work - all versions:

Shipper Colli	1
Gross Weight (kg)	83
Net Weight (kg)	74
Warranty Period	5 years

All Variants

HIGHBACK 3-SEATER

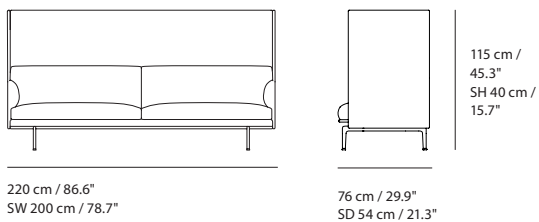

HIGHBACK 3-SEATER — SH 45 CM / 17.7"

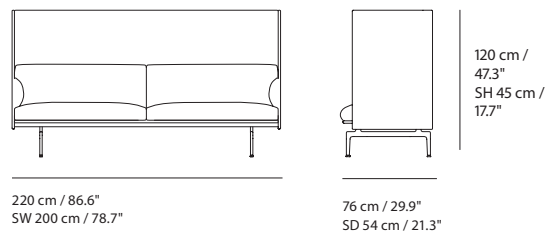

HIGHBACK 2-SEATER

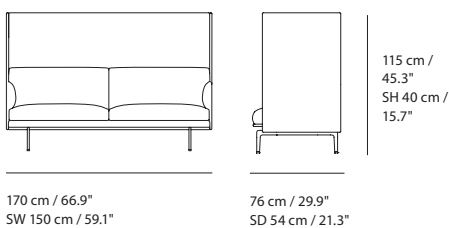

HIGHBACK 2-SEATER — SH 45 CM / 17.7"

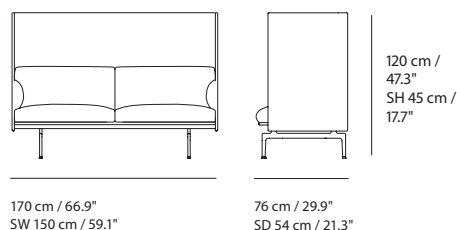

HIGHBACK WORK

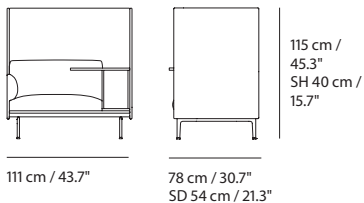

HIGHBACK WORK — SH 45 CM / 17.7"

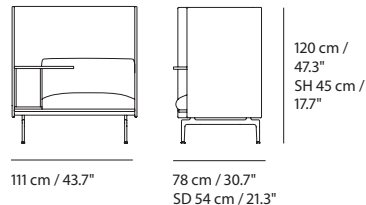

HIGHBACK 1-SEATER

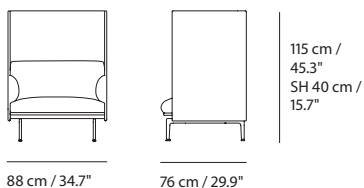

HIGHBACK 1-SEATER — SH 45 CM / 17.7"

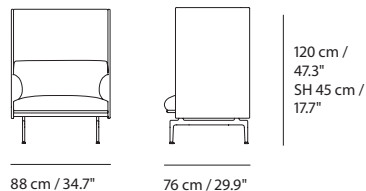

All Variants

				Upholstery Grades									
				COM		CIL			COL				
Pattern No.				A	B	C	E	G	R	T	U	V	W
		Seat Height	Base Color/ hardware										
Outline Highback Sofa	M-OUT-HBSF-2-16-BLCK	15.75"	black	5,511	6,141	6,876	7,030	7,296	8,920	9,970	11,545	12,595	13,645
2-seater - 100cm	M-OUT-HBSF-2-18-BLCK	17.75"	black	5,511	6,141	6,876	7,030	7,296	8,920	9,970	11,545	12,595	13,645
	M-OUT-HBSF-2-16-ALU	15.75"	aluminum	5,770	6,456	7,191	7,296	7,555	9,186	10,236	11,545	12,595	14,170
	M-OUT-HBSF-2-18-ALU	17.75"	aluminum	5,770	6,456	7,191	7,296	7,555	9,186	10,236	11,545	12,595	14,170
Outline Highback Sofa	M-OUT-HBSF-2-16-120-BLCK	15.75"	black	5,875	6,715	7,030	7,240	8,241	9,711	11,545	13,645	13,645	14,695
2-seater - 120cm	M-OUT-HBSF-2-18-120-BLCK	17.75"	black	5,875	6,715	7,030	7,240	8,241	9,711	11,545	13,645	13,645	14,695
	M-OUT-HBSF-2-16-120-ALU	15.75"	aluminum	6,141	6,981	7,296	7,506	8,500	9,970	11,545	13,645	14,170	14,695
	M-OUT-HBSF-2-18-120-ALU	17.75"	aluminum	6,141	6,981	7,296	7,506	8,500	9,970	11,545	13,645	14,170	14,695
Outline Highback Sofa	M-OUT-HBSF-3-16-BLCK	15.75"	black	6,295	7,030	7,450	7,975	8,241	9,970	12,070	12,595	14,695	16,270
3-seater - 100cm	M-OUT-HBSF-3-18-BLCK	17.75"	black	6,295	7,030	7,450	7,975	8,241	9,970	12,070	12,595	14,695	16,270
	M-OUT-HBSF-3-16-ALU	15.75"	aluminum	6,561	7,296	7,716	8,241	8,500	10,236	12,070	13,120	14,695	16,270
	M-OUT-HBSF-3-18-ALU	17.75"	aluminum	6,561	7,296	7,716	8,241	8,500	10,236	12,070	13,120	14,695	16,270
Outline Highback Sofa	M-OUT-HBSF-3-16-120-BLCK	15.75"	black	6,715	7,555	8,080	8,290	9,501	11,545	13,120	15,745	16,270	17,845
3-seater - 120cm	M-OUT-HBSF-3-18-120-BLCK	17.75"	black	6,715	7,555	8,080	8,290	9,501	11,545	13,120	15,745	16,270	17,845
	M-OUT-HBSF-3-16-120-ALU	15.75"	aluminum	6,981	7,821	8,346	8,556	9,760	11,545	13,120	15,745	16,270	17,845
	M-OUT-HBSF-3-18-120-ALU	17.75"	aluminum	6,981	7,821	8,346	8,556	9,760	11,545	13,120	15,745	16,270	17,845

HOW TO CONFIGURE

ORDER CODE EXAMPLE:

Specify:

Outline Highback Sofa 2-seater H 15.75" in Ocean 80 w/black legs

SStep 1) Choose Variant + base color
Step 2) Upholstery option
Step 3) Upholstery color

Variant + base color 2-seater, 15.75" SH - black base
Upholstery option Ocean
Upholstery Color 80
Final Pattern No: MOUTHBSF216BLCKM16180

Base Finish Options

BLCK - Black
ALU - Aluminum

Upholstery Options

A	B	C	E	G	R	T	U	V	W
Mode (M2319) Ocean (M161)* Remix (M156)	Beck (M6376) Cameo (K1443) Canvas (M153) Clara (M154) Fiord (M155) Grain (M12659) Manner (M12665) Pebble Weave (M6374) ** Pecora (M6372) ** Prairie (K1925)* Steelcut (M149) Steelcut Trio (M139) Steelcut Quartet (M13042)	Chameleon (K2372) Color Field (K2226) Hallingdal (M146)	Acca (M12660) Aegean (K2074) Balder (M152) Divina (M150) Divina MD (M147) Divina Melange (M135) Ecriture (M10767) Hearth (M12664) Premiere (K2294) Twill Weave (M142) Vidar (M158)	Modern Tweed (K2155)	Easy Leather (M141)	Refine Leather (M136)	Endure Leather (M137)	Grace Leather (M12374)	Allure Leather (M12375)

*Notes:
*Ocean: Color 3, 21, 32, 50, 52, 80 & 601
Pebble Weave: Color 3, 7, 8, 11, 12, 21
Pecora: Color 6049, 6083, 6084, 6093, 60112
*Prairie: All Additive Free (ADF) Colors

OUTLINE HIGHBACK CABIN



Highback Cabin 100 2-seater
 Shipper Colli: 5
 Gross Weight (kg): 69
 Net Weight (kg): 52
 Warranty Period: 10 years

Highback Cabin 100 3-seater
 Shipper Colli: 5
 Gross Weight (kg): 78
 Net Weight (kg): 58
 Warranty Period: 10 years

Highback Cabin 100 2-seater w/ table
 Shipper Colli: 5
 Gross Weight (kg): 98.5
 Net Weight (kg): 75.5
 Warranty Period: 10 years

Highback Cabin 120 2-seater
 Shipper Colli: 5
 Gross Weight (kg): 82
 Net Weight (kg): 58.5
 Warranty Period: 10 years

Highback Cabin 100 2-seater
 Shipper Colli: 5
 Gross Weight (kg): 92
 Net Weight (kg): 65.5
 Warranty Period: 10 years

Highback Cabin 100 2-seater w/ table
 Shipper Colli: 5
 Gross Weight (kg): 111.5
 Net Weight (kg): 82
 Warranty Period: 10 years

All Variants

HIGHBACK CABIN 2-SEATER 100CM

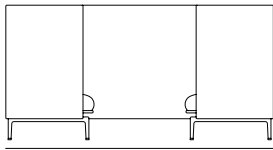

231 cm / 90.94"

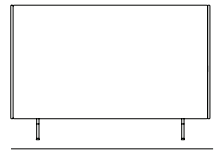

170 cm / 66.9"

115 cm /
 45.3"
 SH 40 cm /
 15.7"

HIGHBACK CABIN 2-SEATER 100CM - SH 45CM

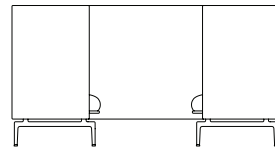

231 cm / 90.94"

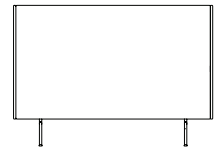

170 cm / 66.9"

120 cm /
 47.3"
 SH 45 cm /
 17.7"

HIGHBACK CABIN 2-SEATER 120CM

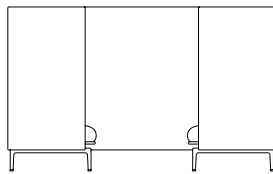

231 cm / 90.94"

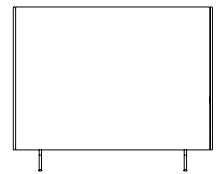

170 cm / 66.9"

140 cm /
 55.12"
 SH 40 cm /
 15.7"

HIGHBACK CABIN 2-SEATER 120CM - SH 45CM

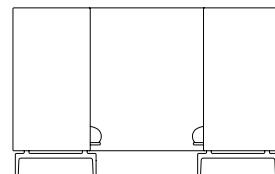

231 cm / 90.94"

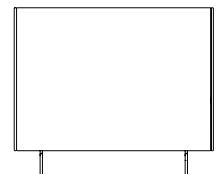

170 cm / 66.9"

145 cm /
 57.09"
 SH 45 cm /
 17.7"

HIGHBACK CABIN 3-SEATER 100CM

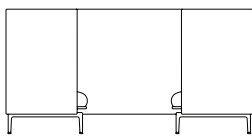

231 cm / 90.94"

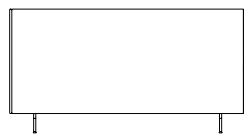

220 cm / 86.6"

115 cm /
 45.3"
 SH 40 cm /
 15.7"

HIGHBACK CABIN 3-SEATER 100CM - SH 45CM

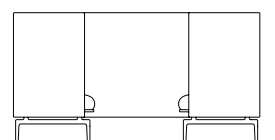

231 cm / 90.94"

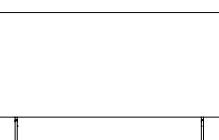

220 cm / 86.6"

120 cm /
 47.3"
 SH 45 cm /
 17.7"

HIGHBACK CABIN 3-SEATER 120CM

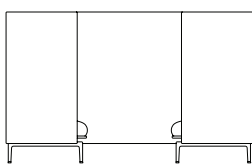

231 cm / 90.94"

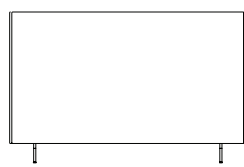

220 cm / 86.6"

140 cm /
 55.12"
 SH 40 cm /
 15.7"

HIGHBACK CABIN 3-SEATER 120CM - SH 45CM

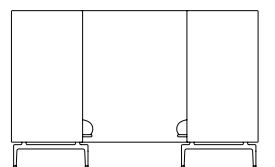

231 cm / 90.94"

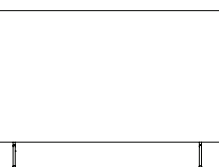

220 cm / 86.6"

145 cm /
 57.09"
 SH 45 cm /
 17.7"

HIGHBACK CABIN 2-SEATER W/ TABLE 100CM - SH 45CM

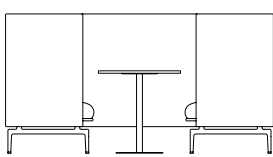

231 cm / 90.94"

Table W 70cm / 27.56"

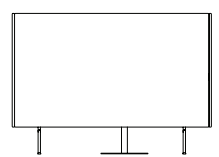

170 cm / 66.9"

120 cm / 47.3"
 SH 45 cm / 17.7"
 Table H 71 cm / 27.95"

HIGHBACK CABIN 2-SEATER 120CM W/ TABLE - SH 45CM

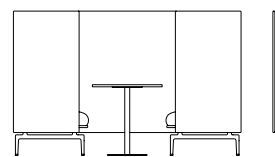

231 cm / 90.94"

Table W 70cm / 27.56"

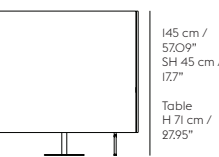

170 cm / 66.9"

145 cm / 57.09"
 SH 45 cm / 17.7"
 Table H 71 cm / 27.95"

OUTLINE HIGHBACK CABIN

All Variants

				Upholstery Grades										
				COM		CIL			COL					
Pattern No.				A	B	C	E	G	R	T	U	V	W	
		Seat Height	Table option	Base/Hard-ware color										
Outline Highback Cabin	M-OUT-HBSC-2-16-N-BLCK	15.75"	without Table	black	11,020	13,120	13,645	14,170	16,795	18,895	21,520	25,195	25,720	28,345
2-Seater - 100cm	M-OUT-HBSC-2-18-N-BLCK	17.75"	without Table	black	11,020	13,120	13,645	14,170	16,795	18,895	21,520	25,195	25,720	28,345
	M-OUT-HBSC-2-18-T-BLCK	17.75"	With Table	black	12,595	14,170	15,220	15,220	16,795	19,945	22,570	26,770	27,820	29,395
	M-OUT-HBSC-2-16-N-ALU	15.75"	without Table	aluminum	11,545	13,645	14,170	14,695	16,795	19,420	22,045	25,720	26,245	28,870
	M-OUT-HBSC-2-18-N-ALU	17.75"	without Table	aluminum	11,545	13,645	14,170	14,695	16,795	19,420	22,045	25,720	26,245	28,870
Outline Highback Cabin	M-OUT-HBSC-2-16-N-120-BLCK	15.75"	without Table	black	12,595	14,695	15,745	15,745	18,370	20,995	24,145	28,870	29,395	31,495
2-seater - 120cm	M-OUT-HBSC-2-18-N-120-BLCK	17.75"	without Table	black	12,595	14,695	15,745	15,745	18,370	20,995	24,145	28,870	29,395	31,495
	M-OUT-HBSC-2-18-T-120-BLCK	17.75"	With Table	black	14,170	15,745	16,795	17,320	19,420	22,570	25,720	30,445	30,970	33,595
	M-OUT-HBSC-2-16-N-120-ALU	15.75"	without Table	aluminum	13,120	15,220	16,270	16,270	18,895	21,520	24,670	29,395	29,395	32,545
	M-OUT-HBSC-2-18-N-120-ALU	17.75"	without Table	aluminum	13,120	15,220	16,270	16,270	18,895	21,520	24,670	29,395	29,395	32,545
Outline Highback Cabin	M-OUT-HBSC-3-16-N-BLCK	15.75"	without table	black	12,595	14,695	15,220	15,745	18,895	21,520	24,670	29,395	29,395	33,070
3-seater - 100cm	M-OUT-HBSC-3-18-N-BLCK	17.75"	without table	black	12,595	14,695	15,220	15,745	18,895	21,520	24,670	29,395	29,395	33,070
	M-OUT-HBSC-3-16-N-ALU	15.75"	without table	aluminum	13,120	15,220	15,745	16,270	19,420	22,045	25,195	29,920	30,445	33,595
	M-OUT-HBSC-3-18-N-ALU	17.75"	without table	aluminum	13,120	15,220	15,745	16,270	19,420	22,045	25,195	29,920	30,445	33,595
Outline Highback Cabin	M-OUT-HBSC-3-16-120-N-BLCK	15.75"	without table	black	14,170	16,270	17,320	17,320	20,995	24,145	27,820	33,070	33,595	36,220
3-seater - 120cm	M-OUT-HBSC-3-18-N-120-BLCK	17.75"	without table	black	14,170	16,270	17,320	17,320	20,995	24,145	27,820	33,070	33,595	36,220
	M-OUT-HBSC-3-16-N-120-ALU	15.75"	without table	aluminum	14,695	16,795	17,845	17,845	20,995	24,670	28,345	33,595	33,595	36,745
	M-OUT-HBSC-3-18-N-120-ALU	17.75"	without table	aluminum	14,695	16,795	17,845	17,845	20,995	24,670	28,345	33,595	33,595	36,745

HOW TO CONFIGURE

ORDER CODE EXAMPLE:

Specify:

Outline Highback Cabin 2-seater - 100cm H 17.75" with Table in Balder 752 w/black legs

SStep 1) Choose Variant + base color
 Step 2) Upholstery option
 Step 3) Upholstery color

Variant + base color 2-seater, 15.75" SH, with Table - black base M-OUTH-HBSC-2-18-T-BLCK
 Upholstery option Balder M152
 Upholstery Color 752 752
 Final Pattern No: MOUTHBSC218T120BLCKM152752

Base Finish Options

BLCK - Black
 ALU - Aluminum
 * Aluminum base not available for Cabin w/ Table

Upholstery Options

A	B	C	E	G	R	T	U	V	W
Mode (M2319) Ocean (M161)* Remix (M156)	Beck (M6376) Cameo (K1443) Canvas (M153) Clara (M154) Fiord (M155) Grain (M12659) Manner (M12665) Pebble Weave (M6374) ** Pecora (M6372) ** Prairie (K1925)* Steelcut (M149) Steelcut Trio (M139) Steelcut Quartet (M13042)	Chameleon (K2372) Color Field (K2226) Hallingdal (M146)	Acca (M12660) Aegean (K2074) Balder (M152) Divina (M150) Divina MD (M147) Divina Melange (M135) Ecriture (M10767) Hearth (M12664) Premiere (K2294) Twill Weave (M142) Vidar (M158)	Modern Tweed (K2155)	Easy Leather (M141)	Refine Leather (M136)	Endure Leather (M137)	Grace Leather (M12374)	Allure Leather (M12375)

*Notes:
 *Ocean: Color 3, 21, 32, 50, 52, 80 & 601
 Pebble Weave: Color 3, 7, 8, 11, 12, 21
 Pecora: Color 6049, 6083, 6084, 6093, 60112
 *Prairie: All Additive Free (ADF) Colors

POWER OUTLET

FOR MORE INFORMATION,
EXPLORE BELOW

- [↗ Product Fact Sheet](#)
- [↗ Images](#)
- [↗ Assembly Instructions](#)

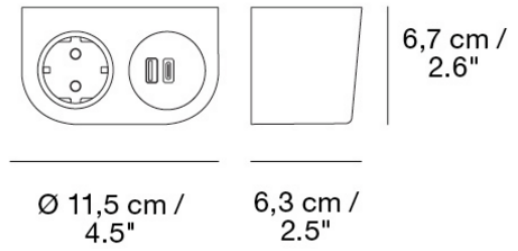

Shipper Colli | 1
Gross Weight (kg) | 0.41
Net Weight (kg) | 0.345
Please note | The Power Outlet can be added to the following products: Outline Sofa Series and Rest Sofa Series.
Warranty Period | 5 years

Pattern No.	Color	Contract Price	Lead Time
Ready-To-Ship US Warehouse			
MPWROUT	Power Outlet - Black	USD 572.00	-

REFLECT SIDEBOARD

FOR MORE INFORMATION,
EXPLORE BELOW

- ↗ [Product Fact Sheet](#)
- ↗ [Images](#)
- ↗ [Architect Files](#)
- ↗ [Assembly Instructions](#)
- ↗ [Product Declaration](#)

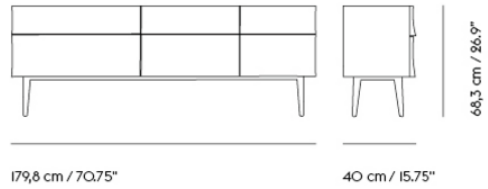

Shipper Colli 1
Gross Weight (kg) 147.6
Net Weight (kg) 71
Please note This product includes 2 drawers and 1 shelf. No additional shelves or drawers can be added.
Warranty Period 5 years

Pattern No.	Color	Contract Price	Lead Time
Ready-To-Ship US Warehouse			
MRFLSBLG-BLCK	Black	USD 4,671.00	-
MRFLSBLG-OAK	Oiled Oak	USD 4,671.00	-

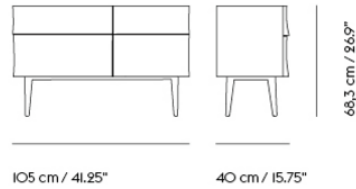

- Shipper Colli 1
- Gross Weight (kg) 92
- Net Weight (kg) 50
- Please note This product includes 2 shelves. No additional shelves can be added.
- Warranty Period 5 years

Pattern No.	Color	Contract Price	Lead Time
Ready-To-Ship EU Warehouse			
MRFLSBSM-BLCK	Black	USD 3,145.00	-
MRFLSBSM-OAK	Oiled Oak	USD 3,145.00	-

RELATE SIDE TABLE

FOR MORE INFORMATION,
EXPLORE BELOW

- ↗ [Product Fact Sheet](#)
- ↗ [Images](#)
- ↗ [Architect Files](#)
- ↗ [Assembly Instructions](#)
- ↗ [Product Declaration](#)

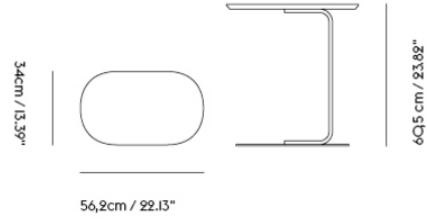

Shipper Colli 1
Gross Weight (kg) 12.577
Net Weight (kg) 11.5
Warranty Period 5 Years

Pattern No.	Color	Contract Price	Lead Time
Ready-To-Ship US Warehouse			
MRELST23-OAK-BLCK	Oak Veneer/Black ***	USD 629.00	-
MRELST23-OAK-OWHT	Oak Veneer/Off-White ***	USD 629.00	-
MRELST23-BLCK-BLCK	Black	USD 576.00	-
MRELST23-BUGY-BUGY	Blue-Grey	USD 576.00	-
MRELST23-DKGN-DKGN	Dark Green	USD 576.00	-
MRELST23-OWHT-OWHT	Off-White	USD 576.00	-
MRELST23-SOAK-OWHT	Solid Oak/Off-White	USD 629.00	-
MRELST23-SMOAK-BLCK	Solid Smoked Oak/Black	USD 629.00	-

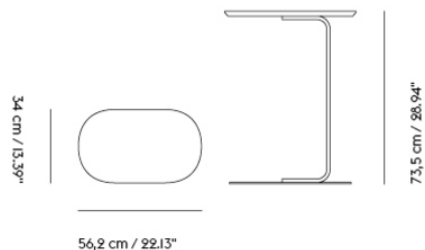

Shipper Colli	1
Gross Weight (kg)	15.65
Net Weight (kg)	14.2
Warranty Period	5 Years

Pattern No.	Color	Contract Price	Lead Time
Ready-To-Ship US Warehouse			
MRELST29-OAK-BLCK	Oak Laminate/Black	USD 667.00	-
MRELST29-OAK-OWHT	Oak Veneer/Off-White ***	USD 667.00	-
MRELST29-BLCK-BLCK	Black	USD 614.00	-
MRELST29-BUGY-BUGY	Blue-Grey	USD 614.00	-
MRELST29-DKGN-DKGN	Dark Green	USD 614.00	-
MRELST29-OWHT-OWHT	Off-White	USD 614.00	-
MRELST29-SOAK-OWHT	Solid Oak/Off-White	USD 667.00	-
MRELST29-SMOAK-BLCK	Solid Smoked Oak/Black	USD 667.00	-

REST SOFA SERIES

FOR MORE INFORMATION,
EXPLORE BELOW

- ↗ [Product Fact Sheet](#)
- ↗ [Images](#)
- ↗ [Architect Files](#)
- ↗ [Assembly Instructions](#)
- ↗ [Product Declaration](#)
- ↗ [Product Configurator](#)

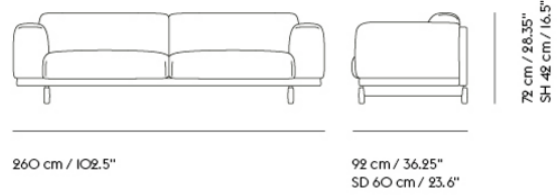

Shipper Colli	1
Gross Weight (kg)	109
Net Weight (kg)	104
Base color options	Oak
Warranty Period	10 years

Pattern No.	Color	Contract Price	Lead Time
-------------	-------	----------------	-----------

Ready-To-Ship US Warehouse

MRSTSF3-M139133	Steelcut Trio 133/Oak ***	USD 6,036.00	-
-----------------	---------------------------	--------------	---

Extras

MLEGSRSF-GREY	Sofa Legs for Rest Sofa 2 and 3-Seater - Grey	USD 198.00	-
MPWR0UT	Power Outlet - Black	USD 572.00	-

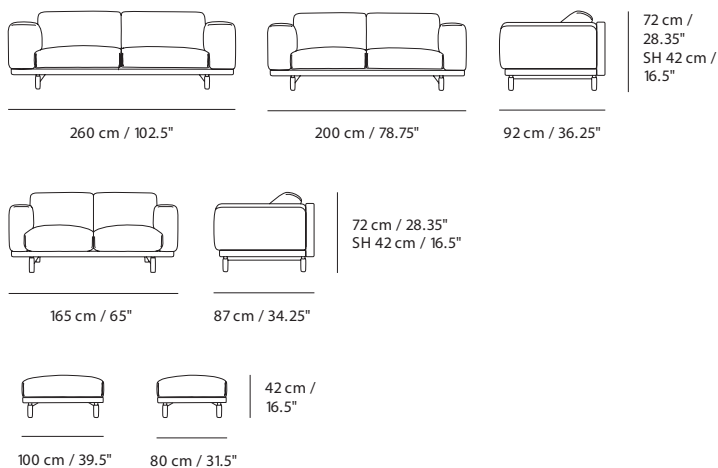

Rest Studio:
Shipper Colli 1
Gross Weight (kg) 75
Net Weight (kg) 70
Warranty Period 10 years

Rest Pouf:
Shipper Colli 1
Gross Weight (kg) 23
Net Weight (kg) 20
Warranty Period 10 years

All Variants

		Upholstery Grades			
		A	COM B	CIL C	E
Pattern No.					
2-seater w/ oak legs	M-RSTSF-2	4,615	5,140	5,406	6,036
3-seater w/ oak legs	M-RSTSF-3	5,140	6,036	6,295	7,240
Pouf	M-RSTP	1,570	1,675	1,836	2,305

HOW TO CONFIGURE

Specify:

- Step 1) Choose Variant
- Step 2) Textile
- Step 3) Textile color

ORDER CODE EXAMPLE:

Rest 2-seater Sofa in Remix 133

Variant	Rest 2-seater sofa	MRSTSF2
Textile	Remix	M156
Textile Color	133	33
Final Pattern No:	MRSTSF2M156133	

Upholstery Options

A	B	C	E
Remix (M156)	Beck (M6376)	Hallingdal (M146)	Acca (M12660)
Vancouver (M148)	Canvas (M153)		Balder (M152)
Wooly (M159)	Clara (M154)		Clay (M2449)
Ocean (161)*	Fiord (M155)		Divina (M150)
	Grain (M12659)		Divina MD (M135)
	Manner (M12665)		Divina Melange (M147)
	Steelcut (M149)		Ecriture (M10767)
	Steelcut Trio (M139)		Hearth (M12664)
			Twill Weave (M142)
			Vidar (M158)

*Notes:
*Ocean: Color 3, 21, 32, 50, 52, 80 & 601

SETTLE OUTDOOR SERIES

FOR MORE INFORMATION,
EXPLORE BELOW

- ↗ [Product Fact Sheet](#)
- ↗ [Images](#)
- ↗ [Architect Files](#)
- ↗ [Assembly Instructions](#)
- ↗ [Product Declaration](#)

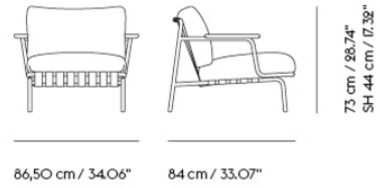

Shipper Colli	1
Gross Weight (kg)	26
Net Weight (kg)	15.7
Base color options	Taupe with Dark Brown webbing. Dark Green or Grey with Grey/White webbing.
Warranty	10 years

Pattern No.	Color	Contract Price	Lead Time
Ready-To-Ship US Warehouse			
MSETL1ST-GREY-M1701	Laze 1/Grey	USD 2,676.00	-
MSETL1ST-TAUP-M1712	Ribbed Weave 2/Dark Green	USD 2,935.00	-
MSETL1ST-TAUP-M1715	Ribbed Weave 5/Taupe	USD 2,935.00	-

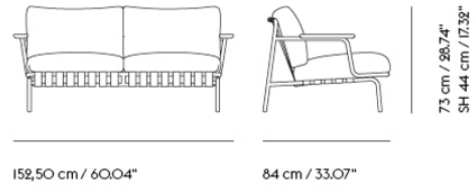

Shipper Colli	1
Gross Weight (kg)	34.4
Net Weight (kg)	24.4
Base color options	Taupe with Dark Brown webbing. Dark Green or Grey with Grey/White webbing.
Warranty	10 years

Pattern No.	Color	Contract Price	Lead Time
Ready-To-Ship US Warehouse			
MSETL2ST-GREY-M1701	Laze 1/Grey	USD 4,041.00	-
MSETL2ST-DKGN-/M1712	Ribbed Weave 2/Dark Green	USD 4,566.00	-
MSETL2ST-TAUP-M1715	Ribbed Weave 5/Taupe	USD 4,566.00	-



Shipper Colli	1
Gross Weight (kg)	44.3
Net Weight (kg)	34
Base color options	Taupe with Dark Brown webbing. Dark Green or Grey with Grey/White webbing.
Warranty	10 years

Pattern No.	Color	Contract Price	Lead Time
Ready-To-Ship US Warehouse			
MSETL3ST-GREY-M1701	Laze 1/Grey	USD 5,350.00	-
MSETL3ST-DKGN-M1712	Ribbed Weave 2/Dark Green	USD 6,295.00	-
MSETL3ST-TAUP-M1715	Ribbed Weave 5/Taupe	USD 6,295.00	-

SOFT TABLE SERIES

FOR MORE INFORMATION,
EXPLORE BELOW

- ↗ [Product Fact Sheet](#)
- ↗ [Images](#)
- ↗ [Assembly Instructions](#)
- ↗ [Architect Files](#)
- ↗ [Product Declaration](#)

SOFT SIDE TABLE / Ø 41 H: 40 CM / Ø 16.1" H: 15.7"

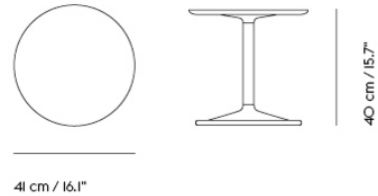

Shipper Colli	2
Gross Weight (kg)	8.873
Net Weight (kg)	7.158
Warranty period	10 years

Pattern No.	Color	Contract Price	Lead Time
Ready-To-Ship US Warehouse			
MSFTSTO1616L-DGRN-DGRN	Dusty Green Laminate/Dusty Green ***	USD 541.00	-
MSFTSTO1616O-OWHT-OWHT	Off-White Linoleum/Off-White ***	USD 541.00	-
MSFTSTO1616L-ORNG-ORNG	Orange Laminate/Orange	USD 541.00	-
MSFTSTO1616N-BLCK-BLCK	Black Nanolaminate/Black	USD 541.00	-
MSFTSTO1616O-GREY-GREY	Grey Linoleum/Grey	USD 541.00	-
MSFTSTO1616W-OWHT-SOAK	Oiled Oak/Off-White ***	USD 629.00	-
MSFTSTO1616O-GREY-SOAK	Solid Oak/Grey	USD 629.00	-
MSFTSTO1616W-BLCK-SMOAK	Solid Smoked Oak/Black	USD 629.00	-
Ready-To-Ship EU Warehouse			
MSFTSTO1616L-BGRN-BGRN	Beige Green Laminate/Beige Green	USD 541.00	-
Extras			
MTSFTSTSCRK-BLCK	Screw Kit for Soft Side Table	USD 23.00	-

SOFT SIDE TABLE / Ø 41 H: 48 CM / Ø 16.1" H: 18.9"

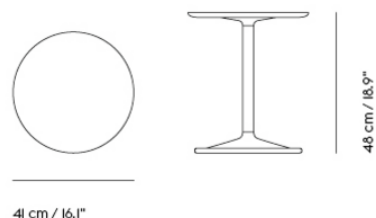

Shipper Colli	2
Gross Weight (kg)	8.873
Net Weight (kg)	7.158
Warranty period	10 years

Pattern No.	Color	Contract Price	Lead Time
Ready-To-Ship US Warehouse			
MSFTSTO1619L-DGRN-DGRN	Dusty Green Laminate/Dusty Green ***	USD 541.00	-
MSFTSTO1619L-ORNG-ORNG	Orange Laminate/Orange	USD 541.00	-
MSFTSTO1619N-BLCK-BLCK	Black Nanolaminate/Black	USD 541.00	-
MSFTSTO1619O-GREY-GREY	Grey Linoleum/Grey	USD 541.00	-
MSFTSTO1619O-OWHT-OWHT	Off-White Linoleum/Off-White ***	USD 541.00	-
MSFTSTO1619W-OWHT-SOAK	Oiled Oak/Off-White ***	USD 629.00	-
MSFTSTO1619W-BLCK-SMOAK	Oiled Smoked Oak/Black	USD 629.00	-
MSFTSTO1619O-GREY-SOAK	Solid Oak/Grey	USD 629.00	-
Ready-To-Ship EU Warehouse			
MSFTSTO1619L-BGRN-BGRN	Beige Green Laminate/Beige Green	USD 541.00	-
Extras			
MTSFTSTSCRK-BLCK	Screw Kit for Soft Side Table	USD 23.00	-

SOFT SIDE TABLE / Ø 48 H: 40 CM / Ø 18.9" H: 15.7"

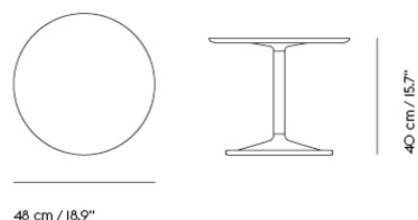

Shipper Colli	2
Gross Weight (kg)	10.776
Net Weight (kg)	8.506
Warranty period	10 years

Pattern No.	Color	Contract Price	Lead Time
Ready-To-Ship US Warehouse			
MSFTSTO1916L-DGRN-DGRN	Dusty Green Laminate/Dusty Green ***	USD 629.00	-
MSFTSTO1916L-ORNG-ORNG	Orange Laminate/Orange	USD 629.00	-
MSFTSTO1916N-BLCK-BLCK	Black Nanolaminate/Black	USD 629.00	-
MSFTSTO1916O-GREY-GREY	Grey Linoleum/Grey	USD 629.00	-
MSFTSTO1916O-OWHT-OWHT	Off-White Linoleum/Off-White ***	USD 629.00	-
MSFTSTO1916W-OWHT-SOAK	Oiled Oak/Off-White ***	USD 719.00	-
MSFTSTO1916W-BLCK-SMOAK	Oiled Smoked Oak/Black	USD 719.00	-
MSFTSTO1916O-GREY-SOAK	Solid Oak/Grey	USD 719.00	-
Ready-To-Ship EU Warehouse			
MSFTSTO1916L-BGRN-BGRN	Beige Green Laminate/Beige Green	USD 629.00	-
Extras			
MTSFTSTSCRK-BLCK	Screw Kit for Soft Side Table	USD 23.00	-

SOFT SIDE TABLE / Ø 48 H: 48 CM / Ø 18.9" H: 18.9"

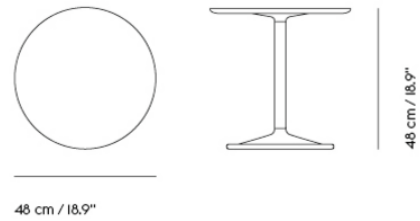

Shipper Colli	2
Gross Weight (kg)	10.776
Net Weight (kg)	8.506
Warranty period	10 years

Pattern No.	Color	Contract Price	Lead Time
Ready-To-Ship US Warehouse			
MSFTSTO1919L-DGRN-DGRN	Dusty Green Laminate/Dusty Green ***	USD 629.00	-
MSFTSTO1919L-ORNG-ORNG	Orange Laminate/Orange	USD 629.00	-
MSFTSTO1919N-BLCK-BLCK	Black Nanolaminate/Black	USD 629.00	-
MSFTSTO1919O-GREY-GREY	Grey Linoleum/Grey	USD 629.00	-
MSFTSTO1919O-OWHT-OWHT	Off-White Linoleum/Off-White ***	USD 629.00	-
MSFTSTO1919W-OWHT-SOAK	Oiled Oak/Off-White ***	USD 719.00	-
MSFTSTO1919W-BLCK-SMOAK	Oiled Smoked Oak/Black	USD 719.00	-
MSFTSTO1919O-GREY-SOAK	Solid Oak/Grey	USD 719.00	-
Ready-To-Ship EU Warehouse			
MSFTSTO1919L-BGRN-BGRN	Beige Green Laminate/Beige Green	USD 629.00	-
Extras			
MTSFTSTSCRK-BLCK	Screw Kit for Soft Side Table	USD 23.00	-

SOFT SIDE TABLE / 45 X 45 H: 40 CM / 17.7 X 17.7 H: 15.7"

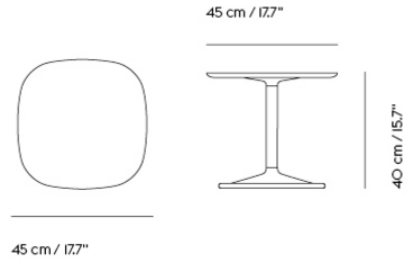

Shipper Colli 2
Gross Weight (kg) 8.939
Net Weight (kg) 7.649
Warranty period 10 years

Pattern No.	Color	Contract Price	Lead Time
Ready-To-Ship US Warehouse			
MSFTSTR171716L-DGRN-DGRN	Dusty Green Laminate/Dusty Green ***	USD 629.00	-
MSFTSTR171716L-ORNG-ORNG	Orange Laminate/Orange ***	USD 629.00	-
MSFTSTR171716N-BLCK-BLCK	Black Nanolaminate/Black ***	USD 629.00	-
MSFTSTR171716O-OWHT-OWHT	Off-White Linoleum/Off-White ***	USD 629.00	-
MSFTSTR171716W-OWHT-SOAK	Oiled Oak/Off-White ***	USD 719.00	-
MSFTSTR171716W-BLCK-SMOAK	Oiled Smoked Oak/Black ***	USD 719.00	-
Extras			
MTSFTSTSCRK-BLCK	Screw Kit for Soft Side Table	USD 23.00	-

SOFT SIDE TABLE / 45 X 45 H: 48 CM / 17.7 X 17.7 H: 18.9"

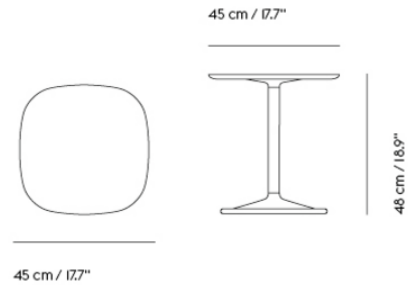

Shipper Colli	2
Gross Weight (kg)	9.02
Net Weight (kg)	7.73
Warranty period	10 years

Pattern No.	Color	Contract Price	Lead Time
Ready-To-Ship US Warehouse			
MSFTSTR171719L-DGRN-DGRN	Dusty Green Laminate/Dusty Green ***	USD 629.00	-
MSFTSTR171719L-ORNG-ORNG	Orange Laminate/Orange ***	USD 629.00	-
MSFTSTR171719N-BLCK-BLCK	Black Nanolaminate/Black ***	USD 629.00	-
MSFTSTR171719O-OWHT-OWHT	Off-White Linoleum/Off-White ***	USD 629.00	-
MSFTSTR171719W-OWHT-SOAK	Oiled Oak/Off-White ***	USD 719.00	-
MSFTSTR171719W-BLCK-SMOAK	Oiled Smoked Oak/Black ***	USD 719.00	-
Extras			
MTSFTSTSCRK-BLCK	Screw Kit for Soft Side Table	USD 23.00	-

SOFT COFFEE TABLE / Ø 75 H: 42 CM / Ø 29.5 H: 16.5"

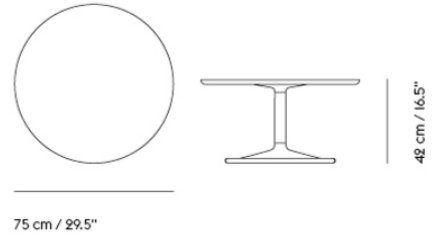

Shipper Colli	3
Gross Weight (kg)	20.923
Net Weight (kg)	16.517
Warranty period	5 years

Pattern No.	Color	Contract Price	Lead Time
Ready-To-Ship US Warehouse			
MSFTCTO3016N-BLCK-BLCK	Black Nanolaminate/Black	USD 1,311.00	-
MSFTCTO3016O-GREY-GREY	Grey Linoleum/Grey	USD 1,206.00	-
MSFTCTO3016W-BLCK-DOAK	Dark Oiled Oak/Black	USD 1,360.00	-
MSFTCTO3016W-GREY-SOAK	Solid Oak/Grey	USD 1,360.00	-
Ready-To-Ship EU Warehouse			
MSFTCTO3016L-BGRN-BGRN	Beige Green Laminate/Beige Green	USD 1,206.00	-
Extras			
MSFTCTSCRK	Screw Kit for Soft Table, Café Table, Coffee Table	USD 24.00	-

SOFT COFFEE TABLE / SOFT COFFEE TABLE / Ø 95 H: 42 CM / Ø 37.4 H: 16.5"

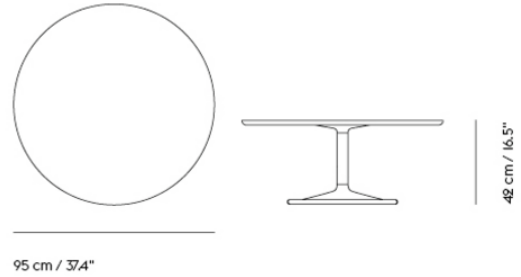

Shipper Colli	3
Gross Weight (kg)	27.823
Net Weight (kg)	22.467
Warranty period	5 years

Pattern No.	Color	Contract Price	Lead Time
Ready-To-Ship US Warehouse			
MSFTCT03716N-BLCK-BLCK	Black Nanolaminate/Black	USD 1,416.00	-
MSFTCT03716O-GREY-GREY	Grey Linoleum/Grey	USD 1,360.00	-
MSFTCT03716W-BLCK-DOAK	Dark Oiled Oak/Black	USD 1,465.00	-
MSFTCT03716W-GREY-SOAK	Solid Oak/Grey	USD 1,465.00	-
Ready-To-Ship EU Warehouse			
MSFTCT03716L-BGRN-BGRN	Beige Green Laminate/Beige Green	USD 1,360.00	-
Extras			
MSFTCTSCRK	Screw Kit for Soft Table, Café Table, Coffee Table	USD 24.00	-

SOFT COFFEE TABLE / 70 X 70 H: 42 CM / 27.6 X 27.6 H: 16.5"

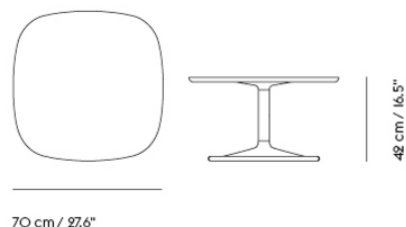

Shipper Colli	3
Gross Weight (kg)	21.823
Net Weight (kg)	17.417
Warranty period	5 years

Pattern No.	Color	Contract Price	Lead Time
Ready-To-Ship US Warehouse			
MSFTCTR303016N-BLCK-BLCK	Black Nanolaminate/Black	USD 1,311.00	-
MSFTCTR303016O-GREY-GREY	Grey Linoleum/Grey	USD 1,206.00	-
MSFTCTR303016W-BLCK-DOAK	Dark Oiled Oak/Black	USD 1,360.00	-
MSFTCTR303016W-GREY-SOAK	Solid Oak/Grey	USD 1,360.00	-
Ready-To-Ship EU Warehouse			
MSFTCTR303016L-BGRN-BGRN	Beige Green Laminate/Beige Green	USD 1,206.00	-
Extras			
MSFTCTSCRK	Screw Kit for Soft Table, Café Table, Coffee Table	USD 24.00	-

SOFT CAFÉ TABLE / 70 X 70 H: 73 CM / 27.6 X 27.6 H: 28.7"

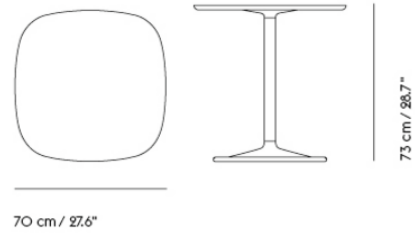

Shipper Colli 3
Gross Weight (kg) 22.3
Net Weight (kg) 17.854
Warranty period 5 years

Pattern No.	Color	Contract Price	Lead Time
Ready-To-Ship US Warehouse			
MSFTCETR282829N-BLCK-BLCK	Black Nanolaminate/Black	USD 1,360.00	-
MSFTCETR282829O-GREY-GREY	Grey Linoleum/Grey	USD 1,311.00	-
MSFTCETR282829W-BLCK-DOAK	Dark Oiled Oak/Black	USD 1,416.00	-
MSFTCETR282829W-GREY-SOAK	Solid Oak/Grey	USD 1,416.00	-
Ready-To-Ship EU Warehouse			
MSFTCETR282829L-BGRN-BGRN	Beige Green Laminate/Beige Green	USD 1,311.00	-
Extras			
MSFTCTSCRK	Screw Kit for Soft Table, Café Table, Coffee Table	USD 24.00	-

SOFT CAFÉ TABLE / 70 X 70 H: 95 CM / 27.6 X 27.6" H: 37.4"

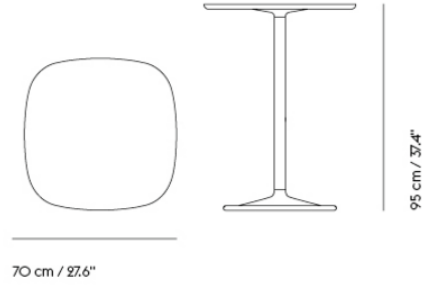

Shipper Colli 3
Gross Weight (kg) 22.623
Net Weight (kg) 18.147
Warranty period 5 years

Pattern No.	Color	Contract Price	Lead Time
Ready-To-Ship US Warehouse			
MSFTCETR282837N-BLCK-BLCK	Black Nanolaminate/Black	USD 1,416.00	-
MSFTCETR282837O-GREY-GREY	Grey Linoleum/Grey	USD 1,360.00	-
MSFTCETR282837W-BLCK-DOAK	Dark Oiled Oak/Black	USD 1,465.00	-
MSFTCETR282837W-GREY-SOAK	Solid Oak/Grey	USD 1,465.00	-
Ready-To-Ship EU Warehouse			
MSFTCETR282837L-BGRN-BGRN	Beige Green Laminate/Beige Green	USD 1,360.00	-
Extras			
MSFTCTSCRK	Screw Kit for Soft Table, Café Table, Coffee Table	USD 24.00	-

SOFT CAFÉ TABLE / 70 X 70 H: 105 CM / 27.6 X 27.6" H: 41.3"

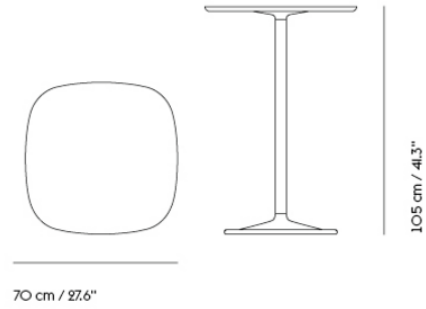

Shipper Colli 3
Gross Weight (kg) 22.777
Net Weight (kg) 18.291
Warranty period 5 years

Pattern No.	Color	Contract Price	Lead Time
Ready-To-Ship US Warehouse			
MSFTCETR282841N-BLCK-BLCK	Black Nanolaminate/Black	USD 1,416.00	-
MSFTCETR282841O-GREY-GREY	Grey Linoleum/Grey	USD 1,360.00	-
MSFTCETR282841W-BLCK-DOAK	Dark Oiled Oak/Black	USD 1,465.00	-
MSFTCETR282841W-GREY-SOAK	Solid Oak/Grey	USD 1,465.00	-
Ready-To-Ship EU Warehouse			
MSFTCETR282841L-BGRN-BGRN	Beige Green Laminate/Beige Green	USD 1,360.00	-
Extras			
MSFTCTSCRK	Screw Kit for Soft Table, Café Table, Coffee Table	USD 24.00	-

SOFT CAFÉ TABLE / Ø 75 H: 73 CM / Ø 29.5 H: 28.7"

399

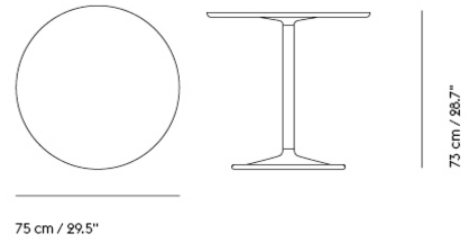

Shipper Colli	3
Gross Weight (kg)	21.4
Net Weight (kg)	16.954
Warranty period	5 years

Pattern No.	Color	Contract Price	Lead Time
Ready-To-Ship US Warehouse			
MSFTCETO2829N-BLCK-BLCK	Black Nanolaminate/Black	USD 1,360.00	-
MSFTCETO2829O-GREY-GREY	Grey Linoleum/Grey	USD 1,311.00	-
MSFTCETO2829W-BLCK-DOAK	Dark Oiled Oak/Black	USD 1,416.00	-
MSFTCETO2829W-GREY-SOAK	Solid Oak/Grey	USD 1,416.00	-
Ready-To-Ship EU Warehouse			
MSFTCETO2829L-BGRN-BGRN	Beige Green Laminate/Beige Green	USD 1,311.00	-
Extras			
MSFTCTSCRK	Screw Kit for Soft Table, Café Table, Coffee Table	USD 24.00	-

SOFT CAFÉ TABLE / Ø 75 CM H: 95 CM / Ø 29.5" H: 37.4"

400

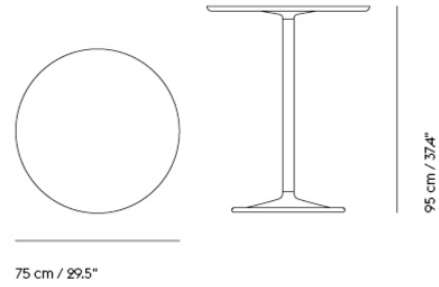

Shipper Colli	3
Gross Weight (kg)	21.723
Net Weight (kg)	17.247
Warranty period	5 years

Pattern No.	Color	Contract Price	Lead Time
Ready-To-Ship US Warehouse			
MSFTCETO2837N-BLCK-BLCK	Black Nanolaminate/Black	USD 1,416.00	-
MSFTCETO2837O-GREY-GREY	Grey Linoleum/Grey	USD 1,360.00	-
MSFTCETO2837W-BLCK-DOAK	Dark Oiled Oak/Black	USD 1,465.00	-
MSFTCETO2837W-GREY-SOAK	Solid Oak/Grey	USD 1,465.00	-
Ready-To-Ship EU Warehouse			
MSFTCETO2837L-BGRN-BGRN	Beige Green Laminate/Beige Green	USD 1,360.00	-
Extras			
MSFTCTSCRK	Screw Kit for Soft Table, Café Table, Coffee Table	USD 24.00	-

SOFT CAFÉ TABLE / Ø 75 H: 105 CM / Ø 29.5" H: 41.3"

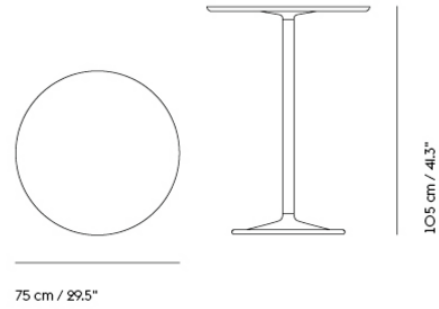

Shipper Colli 3
Gross Weight (kg) 21.877
Net Weight (kg) 17.391
Warranty period 5 years

Pattern No.	Color	Contract Price	Lead Time
Ready-To-Ship US Warehouse			
MSFTCETO2841N-BLCK-BLCK	Black Nanolaminate/Black	USD 1,416.00	-
MSFTCETO2841O-GREY-GREY	Grey Linoleum/Grey	USD 1,360.00	-
MSFTCETO2841W-BLCK-DOAK	Dark Oiled Oak/Black	USD 1,465.00	-
MSFTCETO2841W-GREY-SOAK	Solid Oak/Grey	USD 1,465.00	-
Ready-To-Ship EU Warehouse			
MSFTCETO2841L-BGRN-BGRN	Beige Green Laminate/Beige Green	USD 1,360.00	-
Extras			
MSFTCTSCRK	Screw Kit for Soft Table, Café Table, Coffee Table	USD 24.00	-

**SOFT TABLE / Ø 95 H: 73 CM / Ø 37.4 H:
28.7"**

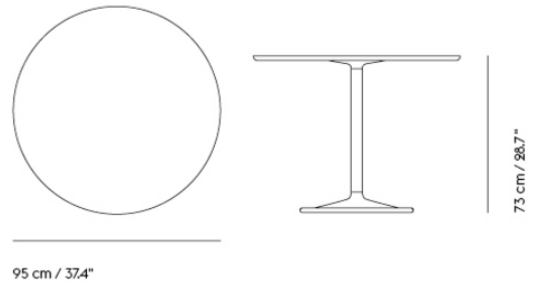

Shipper Colli	3
Gross Weight (kg)	28.3
Net Weight (kg)	22.904
Warranty period	5 years

Pattern No.	Color	Contract Price	Lead Time
Ready-To-Ship US Warehouse			
MSFTT03729N-BLCK-BLCK	Black Nanolaminate/Black	USD 1,465.00	-
MSFTT03729O-GREY-GREY	Grey Linoleum/Grey	USD 1,416.00	-
MSFTT03729W-BLCK-DOAK	Dark Oiled Oak/Black	USD 1,570.00	-
MSFTT03729W-GREY-SOAK	Solid Oak/Grey	USD 1,570.00	-
Ready-To-Ship EU Warehouse			
MSFTT03729L-BGRN-BGRN	Beige Green Laminate/Beige Green	USD 1,416.00	-
Extras			
MSFTCTSCRK	Screw Kit for Soft Table, Café Table, Coffee Table	USD 24.00	-

SOFT TABLE / Ø 95 H: 95 CM / Ø 37.4 H: 37.4"

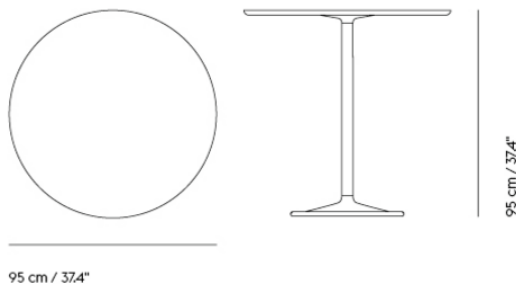

Shipper Colli	3
Gross Weight (kg)	28.623
Net Weight (kg)	23.197
Warranty period	5 years

Pattern No.	Color	Contract Price	Lead Time
Ready-To-Ship US Warehouse			
MSFTT03737N-BLCK-BLCK	Black Nanolaminate/Black	USD 1,570.00	-
MSFTT03737O-GREY-GREY	Grey Linoleum/Grey	USD 1,465.00	-
MSFTT03737W-BLCK-DOAK	Dark Oiled Oak/Black	USD 1,626.00	-
MSFTT03737W-GREY-SOAK	Solid Oak/Grey	USD 1,626.00	-
Ready-To-Ship EU Warehouse			
MSFTT03737L-BGRN-BGRN	Beige Green Laminate/Beige Green	USD 1,465.00	-
Extras			
MSFTCTSCRK	Screw Kit for Soft Table, Café Table, Coffee Table	USD 24.00	-

SOFT TABLE / Ø 95 H: 105 CM / Ø 37.4 H: 41.3"

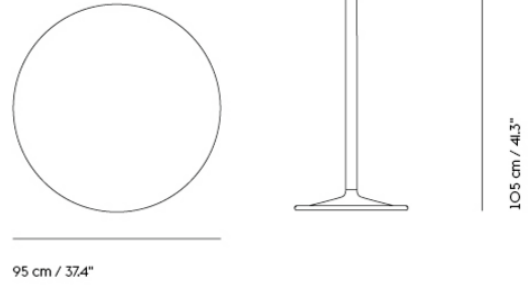

Shipper Colli	3
Gross Weight (kg)	28.777
Net Weight (kg)	23.341
Warranty period	5 years

Pattern No.	Color	Contract Price	Lead Time
Ready-To-Ship US Warehouse			
MSFTT03741N-BLCK-BLCK	Black Nanolaminate/Black	USD 1,570.00	-
MSFTT03741O-GREY-GREY	Grey Linoleum/Grey	USD 1,465.00	-
MSFTT03741W-BLCK-DOAK	Dark Oiled Oak/Black	USD 1,626.00	-
MSFTT03741W-GREY-SOAK	Solid Oak/Grey	USD 1,626.00	-
Ready-To-Ship EU Warehouse			
MSFTT03741L-BGRN-BGRN	Beige Green Laminate/Beige Green	USD 1,465.00	-
Extras			
MSFTCTSCRK	Screw Kit for Soft Table, Café Table, Coffee Table	USD 24.00	-

STACKED STORAGE SYSTEM

FOR MORE INFORMATION,
EXPLORE BELOW

- ↗ [Product Fact Sheet](#)
- ↗ [Images](#)
- ↗ [Architect Files](#)
- ↗ [Assembly Instructions](#)
- ↗ [Product Declaration](#)
- ↗ [Product Planner](#)

Being both versatile and functional, the Stacked Storage System can be arranged and rearranged for the exact configuration that you'd like, whether it be as shelving setups, sideboards, bookcases, or side tables.

Option A — Choose between one of our 24 pre-designed configurations.

Option B — Design your own configuration from scratch using our diverse range of modules, bases, and accessories. Find guidance on the next pages or visit planner.muuto.com/Stacked to create your own configuration online.

The online Product Planner seamlessly integrates every guideline and assembly instruction, ensuring a smoother path to a Stacked Storage System customized for your spatial requirements!

Option A — Choose between one of our 24 pre-designed configurations

Bookcase

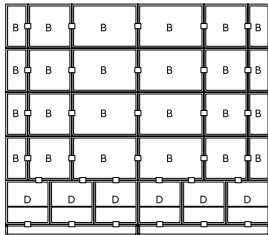

Bookcase 1
W 262 cm / 103.15"
H 228 cm / 89.76"
D 35 cm / 13.78"

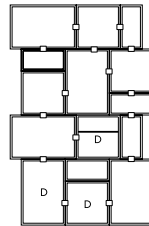

Bookcase 2
W 150 cm / 59.06"
H 218 cm / 85.83"
D 35 cm / 13.78"

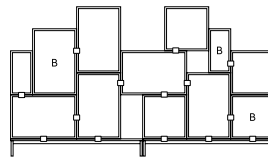

Bookcase 3
W 262 cm / 103.15"
H 148 cm / 58.27"
D 35 cm / 13.78"

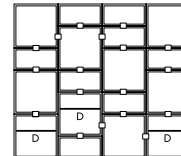

Bookcase 4
W 175 cm / 68.9"
H 153 cm / 60.24"
D 35 cm / 13.78"

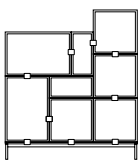

Bookcase 5
W 131 cm / 51.57"
H 148 cm / 58.27"
D 35 cm / 13.78"

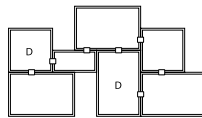

Bookcase 6
W 196 cm / 77.17"
H 109 cm / 42.91"
D 35 cm / 13.78"

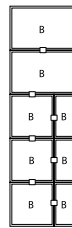

Bookcase 7 (Wall-mounted)
W 65 cm / 25.59"
H 218 cm / 85.83"
D 35 cm / 13.78"

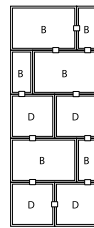

Bookcase 8
W 87 cm / 34.25"
H 218 cm / 85.83"
D 35 cm / 13.78"

Sideboard

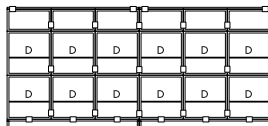

Sideboard 1
W 262 cm / 103.15"
H 121 cm / 47.64"
D 35 cm / 13.78"

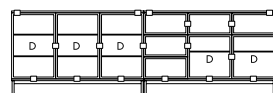

Sideboard 2
W 262 cm / 103.15"
H 85 cm / 33.46"
D 35 cm / 13.78"

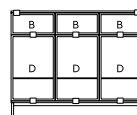

Sideboard 3
W 131 cm / 51.57"
H 106 cm / 41.73"
D 35 cm / 13.78"

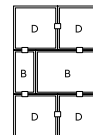

Sideboard 4
W 87 cm / 34.25"
H 131 cm / 51.57"
D 35 cm / 13.78"

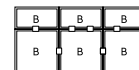

Sideboard 5 (Wall-mounted)
W 131 cm / 51.57"
H 65 cm / 34.25"
D 35 cm / 13.78"

B = module w. backboard
D = module w. door

The illustrations of Clips are for visual reference.

All 24 pre-designed configurations are tested according to European standard EN 16121:30I3+AI:20I7 Test Severity 2.
Please follow assembly rules and configuration guidelines when building your Stacked Storage System configuration.

Hallway

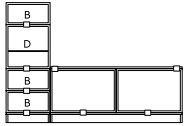

Hallway 1
W 174 cm / 68.5"
H 119 cm / 46.85"
D 35 cm / 13.78"

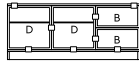

Hallway 2
W 131 cm / 51.57"
H 55 cm / 21.65"
D 35 cm / 13.78"

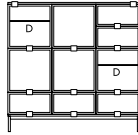

Hallway 3
W 131 cm / 51.57"
H 128 cm / 50.39"
D 35 cm / 13.78"



Hallway 4 (Wall-mounted)
W 87 cm / 34.25"
H 87 cm / 34.25"
D 35 cm / 13.78"

Office

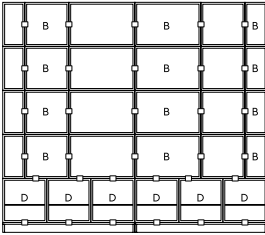

Office 1
W 262 cm / 103.15"
H 228 cm / 89.76"
D 35 cm / 13.78"

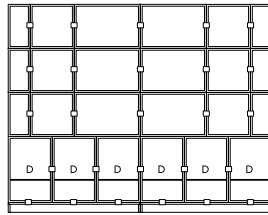

Office 2
W 262 cm / 103.15"
H 206 cm / 81.1"
D 35 cm / 13.78"

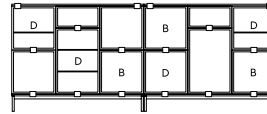

Office 3
W 262 cm / 103.15"
H 106 cm / 41.73"
D 35 cm / 13.78"



Office 4
W 44 cm / 17.32"
H 141 cm / 55.51"
D 35 cm / 13.78"

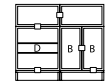

Office 5
W 87 cm / 34.25"
H 75 cm / 29.53"
D 35 cm / 13.78"

Bedside Table



Bedside 1
W 174 cm / 68.5"
H 119 cm / 46.86"
D 35 cm / 13.78"



Bedside 2
W 131 cm / 51.57"
H 55 cm / 21.65"
D 35 cm / 13.78"

Option B — Design your own configuration

STEP 1. BASE

All Modules can be placed directly on the floor and Modules w. Back-board or w. Door can be mounted to a wall. You can also add your desired base, choosing from the base options as seen on the right.

All bases come in 4 different colors: Grey, White, Brown Green, Oak. Podium w. Tube Base always comes with Grey Tube Base.

Notes

When setting up a Stacked Storage System on a Podium or Plinth, attach clips to the bottom of each connected module on both the front and back.

All Podiums and Plinths feature 4 adjustable feet to accommodate uneven floors. Please be aware that for the Plinths, the holes for the adjustable feet at the ends may be visible if not covered by Modules.

A Stacked Podium is tested to withstand a maximum weight of 300 kg / 660 lbs.



Podium w. Tube Base
W 130,8 cm / 51.5"

H 171,5 cm / 6,75"
D 35 cm / 13,78"



Podium w. Tube Base
W 43,6 cm / 17,17"

H 171,5 cm / 6,75"
D 35 cm / 13,78"



Plinth
W 130,8 cm / 51.5"

H 9,8 cm / 3,86"
D 35 cm / 13,78"



Plinth
W 43,6 cm / 17,17"

H 9,8 cm / 3,86"
D 35 cm / 13,78"

STEP 2. MODULES

Select the Modules of your configuration, choosing from the modules shown on the right.

All modules come in 4 different colors: Grey, White, Brown Green, Oak.

Notes







You must only stack a maximum of 5 Modules on top of each other, reaching a height no taller than 240 cm / 94.49 inches.

Door Modules must always be placed so the door opens vertically. Never place Door Modules horizontally.

Position Stacked Medium w. Door Modules no higher than 148 cm / 58.26 inches above the ground. Stacked Large w. Door Modules should only be placed on the 1st row of a configuration.

A Stacked Module is tested to hold up to 25 kg / 55 lbs.

A wall-mounted Stacked Module is tested to hold up to 12 kg / 26.5 lbs.

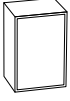
				H 43,6 cm / 17,95" D 35 cm / 13,78"	
Small Open W 21,8 cm / 8,58"	Small w. Backboard W 21,8 cm / 8,58"				
					H 43,6 cm / 17,95" D 35 cm / 13,78"
Medium Open W 43,6 cm / 17,17"	Medium w. Backboard W 43,6 cm / 17,17"	Medium w. Door W 43,6 cm / 17,17"			
					H 43,6 cm / 17,95" D 35 cm / 13,78"
Large Open W 65,4 cm / 25,75"	Large w. Backboard W 65,4 cm / 25,75"	Large w. Door W 65,4 cm / 25,75"			

STEP 3. TOP PLATE OR SEAT CUSHION

If relevant, add your desired number of Top Plates for a nice finish when e.g. building a sideboard configuration. Add a Seat Cushion to create a cozy nook providing additional comfort, e.g. when building a bench for your Hallway.





Top Plates come in 4 different colors: Grey, White, Brown Green, Oak.

Notes

Do not build any Stacked Storage Systems taller than 130 cm / 51.18" when building a configuration with a Top Plate. Do not build with a Top Plate if the configuration is wall-mounted.

When building with a Top Plate, minimum 4 Clips must be placed in each corner to secure the Top Plate.

The Top Plate(s) must be placed evenly on the Modules, meaning that the Top Plate(s) must not be placed so that the Top Plate(s) are sticking out from the side of the Modules beneath.



			H 1,85 cm / 73" D 35 cm / 13,78"
Top Plate L 130,8 cm / 51,57"			
			H 1,85 cm / 73" D 35 cm / 13,78"
Top Plate L 43,6 cm / 17,17"			
			H 5 cm / 1,97" D 35 cm / 13,78"
Seat Cushion Leather L 131 cm / 51,57"			
			H 5 cm / 1,97" D 35 cm / 13,78"
Seat Cushion Textile L 131 cm / 51,57"			

STEP 4. SHELVES

Add your desired Shelves or Inserts.

Shelves come in 4 different colors: Grey, White, Brown Green, Oak.

Inserts come in 2 different colors: Grey, Blue Grey.

	H 1,05 cm / 41" D 28,7 cm / 11,3"		H 9,0 cm / 7,87" D 28,2 cm / 11,1"
Shelf W 39,7 cm / 15,63"		Insert W 39,6 cm / 15,59"	

Notes

Shelves can be positioned in two fixed positions inside modules w. door. Inserts can be placed in open modules and modules w. backboard.

STEP 5. CLIPS

Each module comes with two Clips in the same color as the module, while Oak comes with two Clips in Grey.

Identify the amount of possible extra Clips required to connect the modules in your configuration, following the guidelines below.

	H 4,1 cm / 1,61" D 2,39 cm / 94"
Clip W 4,17 cm / 1,64"	

Notes

Clips must always be used when joining together Modules, Bases and Top Plates. The Clips must connect the elements in the system from left to right to ensure the overall stability of the Stacked Storage System.

As a general rule, attach one clip to the front and one to the back of each module. When placing a Stacked clip on the backside of a Stacked Module with a Door, you must always position it at the bottom, both at the front and back.

Extra clips can be purchased separately to increase the configuration's stability. You can buy extra Clips in set of two.

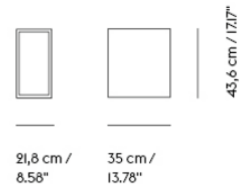

Shipper Colli 1
Gross Weight (kg) 8.9
Net Weight (kg) 6.7
Warranty period 5 years

Pattern No.	Color	Contract Price	Lead Time
Ready-To-Ship US Warehouse			
MSSTMSO-BRGR	Brown Green	USD 226.00	-
MSSTMSO-GREY	Grey ***	USD 226.00	-
MSSTMSO-MBLU	Midnight Blue ***	USD 226.00	-
MSSTMSO-OAK	Oak	USD 226.00	-
MSSTMSO-WHIT	White	USD 226.00	-

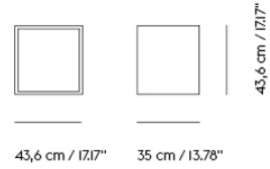

Shipper Colli 1
Gross Weight (kg) 11.9
Net Weight (kg) 9.1
Warranty period 5 years

Pattern No.	Color	Contract Price	Lead Time
Ready-To-Ship US Warehouse			
MSSTMMO-BRGR	Brown Green	USD 289.00	-
MSSTMMO-GREY	Grey ***	USD 289.00	-
MSSTMMO-OAK	Oak	USD 289.00	-
MSSTMMO-WHIT	White	USD 289.00	-

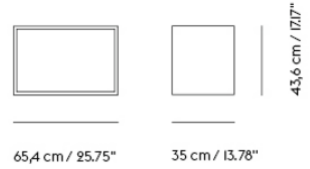

Shipper Colli 1
Gross Weight (kg) 14.8
Net Weight (kg) 11.8
Warranty period 5 years

Pattern No.	Color	Contract Price	Lead Time
Ready-To-Ship US Warehouse			
MSSTMLO-BRGR	Brown Green	USD 331.00	-
MSSTMLO-GREY	Grey ***	USD 331.00	-
MSSTMLO-OAK	Oak	USD 331.00	-
MSSTMLO-WHIT	White	USD 331.00	-

STACKED STORAGE SYSTEM / SMALL WITH BACKBOARD

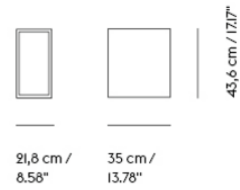

Shipper Colli 1
Gross Weight (kg) 10
Net Weight (kg) 7.2
Warranty period 5 years

Pattern No.	Color	Contract Price	Lead Time
Ready-To-Ship US Warehouse			
MSSTMSB-BRGR	Brown Green	USD 257.00	-
MSSTMSB-GREY	Grey ***	USD 257.00	-
MSSTMSB-MBLU	Midnight Blue ***	USD 257.00	-
MSSTMSB-OAK	Oak	USD 257.00	-
MSSTMSB-WHIT	White	USD 257.00	-
Extras			
MSSTMSBMGKT-BLCK	Stacked Wall Mount Set - Small Modules	USD 14.00	-

STACKED STORAGE SYSTEM / MEDIUM WITH BACKBOARD

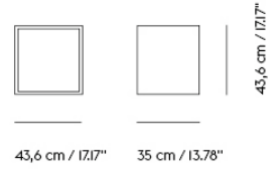

Shipper Colli 1
Gross Weight (kg) 13.3
Net Weight (kg) 10.2
Warranty period 5 years

Pattern No.	Color	Contract Price	Lead Time
Ready-To-Ship US Warehouse			
MSSTMMB-BRGR	Brown Green	USD 331.00	-
MSSTMMB-GREY	Grey ***	USD 331.00	-
MSSTMMB-OAK	Oak	USD 331.00	-
MSSTMMB-OGREY	Oak/Grey	USD 331.00	-
MSSTMMB-WHIT	White	USD 331.00	-

STACKED STORAGE SYSTEM / LARGE WITH BACKBOARD

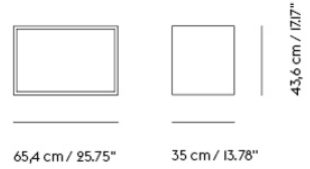

Shipper Colli 1
Gross Weight (kg) 16.42
Net Weight (kg) 12.8
Warranty period 5 years

Pattern No.	Color	Contract Price	Lead Time
Ready-To-Ship US Warehouse			
MSSTMLB-BRGR	Brown Green	USD 362.00	-
MSSTMLB-GREY	Grey ***	USD 362.00	-
MSSTMLB-OAK	Oak	USD 362.00	-
MSSTMLB-WHIT	White	USD 362.00	-
Extras			
MSSTMLBMGKT-BLCK	Stacked Wall Mount Set - Large Modules	USD 14.00	-

STACKED STORAGE SYSTEM / MEDIUM WITH DOOR

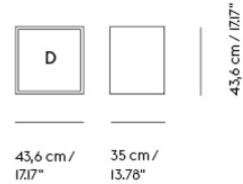

Shipper Colli 1
Gross Weight (kg) 15.5
Net Weight (kg) 12.3
Warranty period 5 years

Pattern No.	Color	Contract Price	Lead Time
Ready-To-Ship US Warehouse			
MSSTMMD-BRGR	Brown Green	USD 341.00	-
MSSTMMD-MBLU	Midnight Blue ***	USD 341.00	-
MSSTMMD-OAK	Oak	USD 341.00	-
MSSTMMD-WHIT	White	USD 341.00	-
Ready-To-Ship EU Warehouse			
MSSTMMD-GREY	Grey	USD 341.00	-
Extras			
MSSTMSLF-BRGR	Shelf - Brown Green	USD 142.00	-
MSSTMSLF-GREY	Shelf - Grey	USD 142.00	-
MSSTMSLF-OAK	Shelf - Oak	USD 142.00	-
MSSTMSLF-WHIT	Shelf - White	USD 142.00	-

STACKED STORAGE SYSTEM / LARGE WITH DOOR

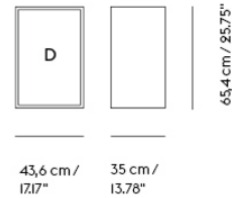

Shipper Colli 1
Gross Weight (kg) 17.5
Net Weight (kg) 12.5
Warranty period 5 years

Pattern No.	Color	Contract Price	Lead Time
Ready-To-Ship US Warehouse			
MSSTMLD-BRGR	Brown Green	USD 450.00	-
MSSTMLD-OAK	Oak	USD 450.00	-
MSSTMLD-WHIT	White	USD 450.00	-
Ready-To-Ship EU Warehouse			
MSSTMLD-GREY	Grey	USD 450.00	-
Extras			
MSSTMLBMGKT-BLCK	Stacked Wall Mount Set - Large Modules	USD 14.00	-
MSSTMSLF-BRGR	Shelf - Brown Green	USD 142.00	-
MSSTMSLF-GREY	Shelf - Grey	USD 142.00	-
MSSTMSLF-OAK	Shelf - Oak	USD 142.00	-
MSSTMSLF-WHIT	Shelf - White	USD 142.00	-

**STACKED STORAGE SYSTEM / PLINTH -
43,5 X 35 H: 10 CM / 17.15 X 13.75 H: 3.8"**

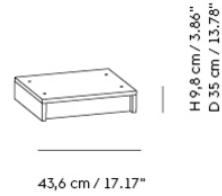

Shipper Colli 1
Gross Weight (kg) 5.2
Net Weight (kg) 3.9
Warranty period 5 years

Pattern No.	Color	Contract Price	Lead Time
Ready-To-Ship US Warehouse			
MSSTMSHPL-BRGR	Brown Green	USD 394.00	-
MSSTMSHPL-OAK	Oak	USD 394.00	-
MSSTMSHPL-WHIT	White	USD 394.00	-
Ready-To-Ship EU Warehouse			
MSSTMSHPL-GREY	Grey	USD 394.00	-

STACKED STORAGE SYSTEM / PLINTH - 131
X 35 H: 10 CM / 51.5 X 13.75 H: 3.8"

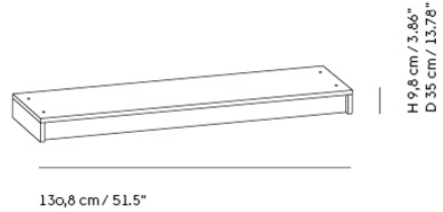

Shipper Colli |
 Gross Weight (kg) | 12.4
 Net Weight (kg) | 8.96
 Warranty period | 5 years

Pattern No.	Color	Contract Price	Lead Time
Ready-To-Ship US Warehouse			
MSSTMLNPL-BRGR	Brown Green	USD 530.00	-
MSSTMLNPL-OAK	Oak	USD 530.00	-
MSSTMLNPL-WHIT	White	USD 530.00	-
Ready-To-Ship EU Warehouse			
MSSTMLNPL-GREY	Grey	USD 530.00	-

**STACKED STORAGE SYSTEM / PODIUM W.
TUBE BASE - 43,5 X 35 H: 17 CM / 17.15 X
13.75 H: 6.75"**



Shipper Colli 2
Gross Weight (kg) 4.2
Net Weight (kg) 3.8
Warranty period 5 years

Pattern No.	Color	Contract Price	Lead Time
Ready-To-Ship US Warehouse			
MSSTMSHPD-BRGR	Brown Green/Grey	USD 450.00	-
MSSTMSHPD-OAK	Oak/Grey	USD 450.00	-
MSSTMSHPD-WHIT	White/Grey	USD 450.00	-
Ready-To-Ship EU Warehouse			
MSSTMSHPD-GREY	Grey/Grey	USD 450.00	-

**STACKED STORAGE SYSTEM / PODIUM W.
TUBE BASE - 131 X 35 H: 17 CM / 51.5 X 13.75
H: 6.75"**

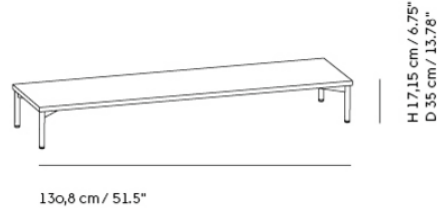

Shipper Colli 2
 Gross Weight (kg) 10.8
 Net Weight (kg) 8.3
 Warranty period 5 years

Pattern No.	Color	Contract Price	Lead Time
Ready-To-Ship US Warehouse			
MSSTMLNPD-BRGR	Brown Green/Grey	USD 660.00	-
MSSTMLNPD-OAK	Oak/Grey	USD 660.00	-
MSSTMLNPD-WHIT	White/Grey	USD 660.00	-
Ready-To-Ship EU Warehouse			
MSSTMLNPD-GREY	Grey/Grey	USD 660.00	-



Shipper Colli 1
Gross Weight (kg) 2.8
Net Weight (kg) 2.7
Please note Inserts can be placed in open modules and modules w. backboard.
Warranty period 5 years

Pattern No.	Color	Contract Price	Lead Time
Ready-To-Ship US Warehouse			
MSSTMIN-BLGY	Blue Grey	USD 100.00	-
Ready-To-Ship EU Warehouse			
MSSTMIN-GREY	Grey	USD 100.00	-



Shipper Colli 1
Gross Weight (kg) 1.5
Net Weight (kg) 0.88
Please note The Stacked Storage System Shelves can be added to the Stacked Storage System Modules w. Door
Please note Shelves can be positioned in two fixed positions inside modules w. door.
Warranty period 5 years

Pattern No.	Color	Contract Price	Lead Time
Ready-To-Ship US Warehouse			
MSSTMSLF-BRGR	Shelf - Brown Green	USD 142.00	-
MSSTMSLF-OAK	Shelf - Oak	USD 142.00	-
MSSTMSLF-WHIT	Shelf - White	USD 142.00	-
Ready-To-Ship EU Warehouse			
MSSTMSLF-GREY	Shelf - Grey	USD 142.00	-

STACKED STORAGE SYSTEM / TOP PLATE - 43,5 X 35 / 17.15 X 13.75"



Shipper Colli 1
Gross Weight (kg) 2.5
Net Weight (kg) 1.75
Warranty period 5 years

Pattern No.	Color	Contract Price	Lead Time
Ready-To-Ship US Warehouse			
MSSTMSHTP-BRGR	Brown Green	USD 226.00	-
MSSTMSHTP-OAK	Oak	USD 226.00	-
MSSTMSHTP-WHIT	White	USD 226.00	-
Ready-To-Ship EU Warehouse			
MSSTMSHTP-GREY	Grey	USD 226.00	-

**STACKED STORAGE SYSTEM / TOP PLATE -
131 X 35 / 51.5 X 13.75"**

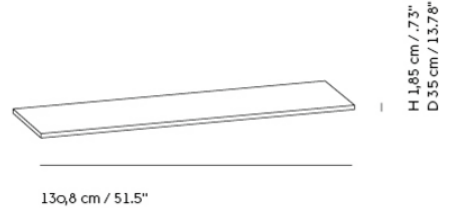

Shipper Colli |
 Gross Weight (kg) 7.5
 Net Weight (kg) 5.19
 Warranty period 5 years

Pattern No.	Color	Contract Price	Lead Time
Ready-To-Ship US Warehouse			
MSSTMLNTP-BRGR	Brown Green	USD 335.00	-
MSSTMLNTP-OAK	Oak	USD 335.00	-
MSSTMLNTP-WHIT	White	USD 335.00	-
Ready-To-Ship EU Warehouse			
MSSTMLNTP-GREY	Grey	USD 335.00	-

STACKED STORAGE SYSTEM / EXTRA CLIPS (2 PCS)

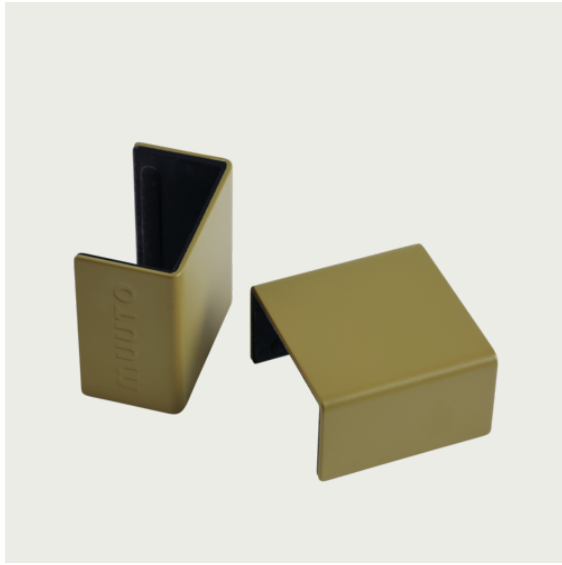

Shipper Colli | 1
Gross Weight (kg) | 0.078
Net Weight (kg) | 0.073
Warranty period | 5 years

Pattern No.	Color	Contract Price	Lead Time
Ready-To-Ship US Warehouse			
MSSTC2PC-DGRN	Brown Green	USD 35.00	-
MSSTC2PC/GREY	Grey	USD 35.00	-
MSSTC2PC/WHIT	White	USD 35.00	-

**STACKED STORAGE SYSTEM / ACOUSTIC
PANEL / SMALL**

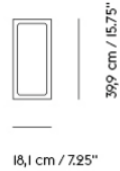
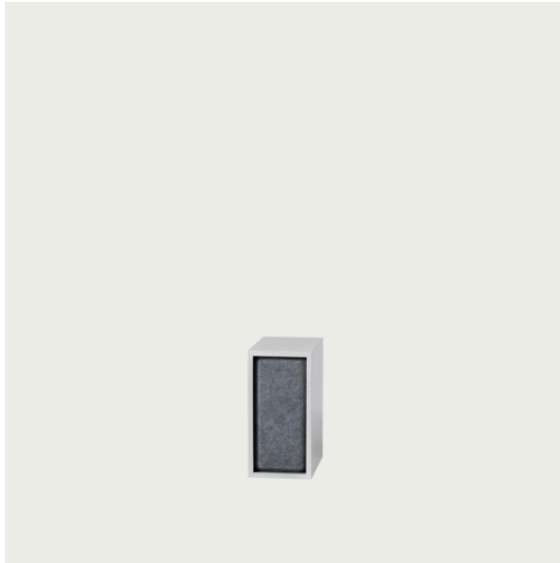

Shipper Colli 1
 Gross Weight (kg) 0.25
 Net Weight (kg) 0.15
 Warranty period 5 years

Pattern No.	Color	Contract Price	Lead Time
Ready-To-Ship EU Warehouse			
MSSTAPSM-AQME	Aqua Mélange ***	USD 72.00 >MOQ: 2	-
MSSTAPSM-BLME	Black Mélange ***	USD 72.00 >MOQ: 2	-
MSSTAPSM-GRME	Grey Mélange ***	USD 72.00 >MOQ: 2	-

STACKED STORAGE SYSTEM / ACOUSTIC PANEL - MEDIUM

427

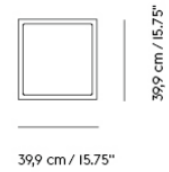
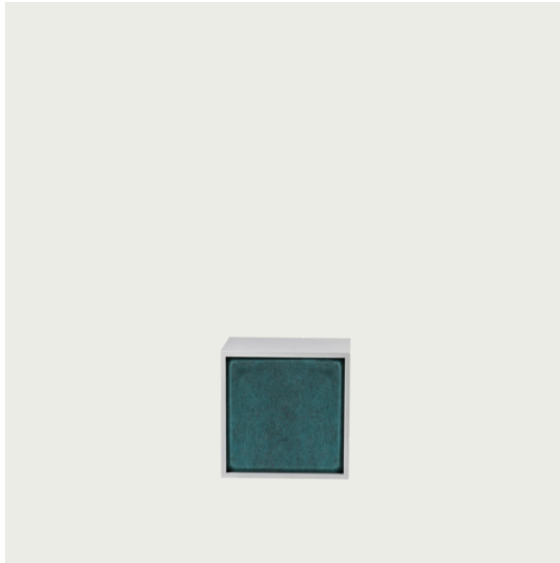

Shipper Colli 1
Gross Weight (kg) 0.4
Net Weight (kg) 0.3
Warranty period 5 years

Pattern No.	Color	Contract Price	Lead Time
Ready-To-Ship EU Warehouse			
MSSTAPMD-AQME	Aqua Mélange	USD 100.00 >MOQ: 2	-
MSSTAPMD-BLME	Black Mélange	USD 100.00 >MOQ: 2	-
MSSTAPMD-GRME	Grey Mélange	USD 100.00 >MOQ: 2	-

STACKED STORAGE SYSTEM / ACOUSTIC PANEL / LARGE

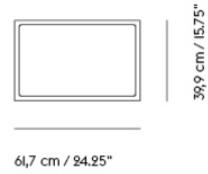

Shipper Colli 1
Gross Weight (kg) 0.6
Net Weight (kg) 0.5
Warranty period 5 years

Pattern No.	Color	Contract Price	Lead Time
Ready-To-Ship EU Warehouse			
MSSTAPLG-BLME	Black Mélange	USD 121.00 >MOQ: 2	-
MSSTAPLG-GRME	Grey Mélange	USD 121.00 >MOQ: 2	-

STACKED STORAGE SYSTEM / SEAT CUSHION



Shipper Colli |
Net Weight (kg) 3.9
Warranty Period 5 years

Pattern No.	Color	Contract Price	Lead Time
Ready-To-Ship US Warehouse			
MSSTCUS5113-M637649	Beck 49	USD 492.00	-
MSSTCUS5113-M136COGN	Refine Leather Cognac - I31 X 35 / 51.5 X 13.75"	USD 660.00	-
Made-To-Order			
MSSTCUS5113-M12665CONFIGURE	Manner - All Colors	USD 394.00	13-15 weeks
MSSTCUS5113-M161CONFIGURE	Ocean - Color 3, 2l, 32, 50, 52, 80 & 60l	USD 394.00	13-15 weeks
MSSTCUS5113-M161CONFIGURE	Remix - All Colors	USD 394.00	13-15 weeks
MSSTCUS5113-M159CONFIGURE	Wooly - All Colors	USD 394.00	13-15 weeks
MSSTCUS5113-M6376CONFIGURE	Beck - All Colors	USD 492.00	13-15 weeks
MSSTCUS5113-M153CONFIGURE	Canvas - All Colors	USD 492.00	13-15 weeks
MSSTCUS5113-M154CONFIGURE	Clara - All Colors	USD 492.00	13-15 weeks
MSSTCUS5113-M155CONFIGURE	Fiord - All Colors	USD 492.00	13-15 weeks
MSSTCUS5113-M12659CONFIGURE	Grain - All Colors	USD 492.00	13-15 weeks
MSSTCUS5113-M4586CONFIGURE	Re-wool - All Colors	USD 492.00	13-15 weeks
MSSTCUS5113-M8404CONFIGURE	Sabi - All Colors	USD 492.00	13-15 weeks
MSSTCUS5113-M149CONFIGURE	Steelcut - All Colors	USD 492.00	13-15 weeks

Pattern No.	Color	Contract Price	Lead Time
MSSTCUS5113-M139CONFIGURE	Steelcut Trio - All Colors	USD 492.00	13-15 weeks
MSSTCUS5113-M146CONFIGURE	Hallingdal - All Colors	USD 530.00	13-15 weeks
MSSTCUS5113-M141CONFIGURE	Easy Leather - All Colors	USD 572.00	13-15 weeks
MSSTCUS5113-M12660CONFIGURE	Acca - All Colors	USD 597.00	13-15 weeks
MSSTCUS5113-M152CONFIGURE	Balder - All Colors	USD 597.00	13-15 weeks
MSSTCUS5113-M150CONFIGURE	Divina - All Colors	USD 597.00	13-15 weeks
MSSTCUS5113-M147CONFIGURE	Divina MD - All Colors	USD 597.00	13-15 weeks
MSSTCUS5113-M135CONFIGURE	Divina Melange - All Colors	USD 597.00	13-15 weeks
MSSTCUS5113-M10767CONFIGURE	Ecriture - All Colors	USD 597.00	13-15 weeks
MSSTCUS5113-M12664CONFIGURE	Hearth - All Colors	USD 597.00	13-15 weeks
MSSTCUS5113-M142CONFIGURE	Twill Weave - All Colors	USD 597.00	13-15 weeks
MSSTCUS5113-M158CONFIGURE	Vidar - All Colors	USD 597.00	13-15 weeks
MSSTCUS5113-M136CONFIGURE	Refine Leather - All Colors	USD 660.00	13-15 weeks
MSSTCUS5113-M137CONFIGURE	Endure Leather - All Colors	USD 719.00	13-15 weeks
MSSTCUS5113-M12374CONFIGURE	Grace Leather - All Colors	USD 877.00	13-15 weeks
MSSTCUS5113-M12375CONFIGURE	Allure Leather - All Colors	USD 982.00	13-15 weeks

STACKED STORAGE SYSTEM / BEDSIDE TABLE - CONFIGURATION I

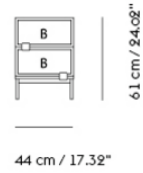
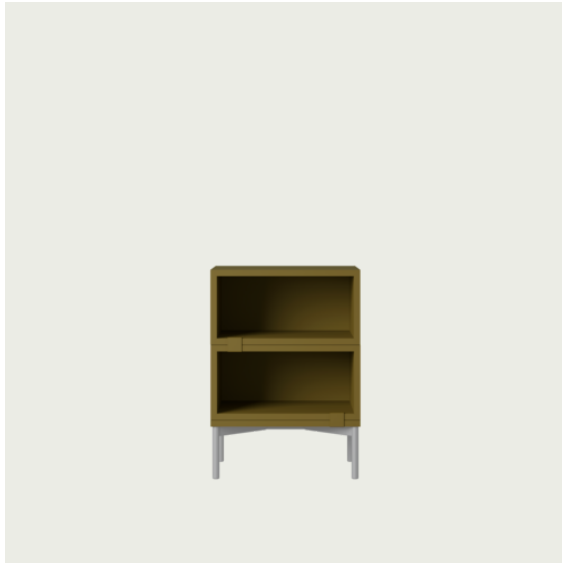

Shipper Colli 4
Gross Weight (kg) 22.8
Net Weight (kg) 16.24
Warranty period 5 years

Pattern No.	Color	Contract Price	Lead Time
Ready-To-Ship US Warehouse			
MSSTCBS1-BRGR	Brown Green	USD 950.00	-
MSSTCBS1-OAK	Oak	USD 950.00	-
MSSTCBS1-WHIT	White	USD 950.00	-
Ready-To-Ship EU Warehouse			
MSSTCBS1-GREY	Grey	USD 950.00	-

STACKED STORAGE SYSTEM / BEDSIDE TABLE - CONFIGURATION 2

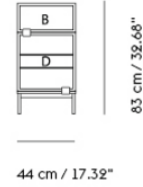

Shipper Colli 6
Gross Weight (kg) 29.1
Net Weight (kg) 21.005
Warranty period 5 years

Pattern No.	Color	Contract Price	Lead Time
Ready-To-Ship US Warehouse			
MSSTCBS2-BRGR	Brown Green	USD 1,311.00	-
MSSTCBS2-OAK	Oak	USD 1,311.00	-
MSSTCBS2-WHIT	White	USD 1,311.00	-
Ready-To-Ship EU Warehouse			
MSSTCBS2-GREY	Grey	USD 1,311.00	-

**STACKED STORAGE SYSTEM / BOOKCASE
- CONFIGURATION I**

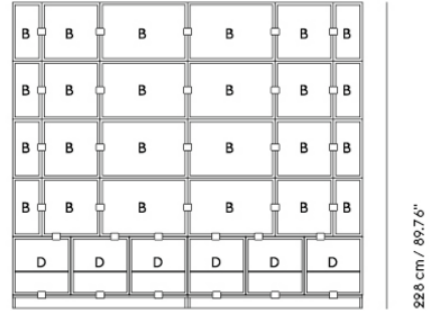

262 cm / 103.15"

228 cm / 89.76"

Shipper Colli 40
 Gross Weight (kg) 402.6
 Net Weight (kg) 297.04
 Warranty period 5 years

Pattern No.	Color	Contract Price	Lead Time
Ready-To-Ship US Warehouse			
MSSTCB1-BRGR	Brown Green	USD 11,545.00	-
MSSTCB1-OAK	Oak	USD 11,545.00	-
MSSTCB1-WHIT	White	USD 11,545.00	-
Ready-To-Ship EU Warehouse			
MSSTCB1-GREY	Grey	USD 11,545.00	-

STACKED STORAGE SYSTEM / BOOKCASE - CONFIGURATION 2

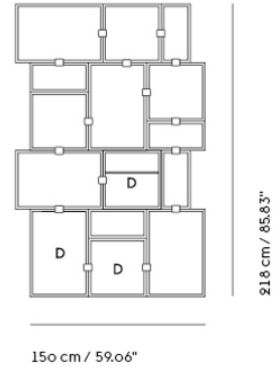
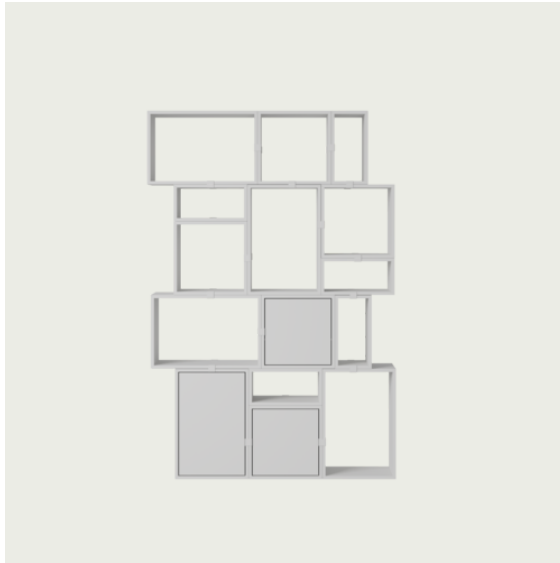

Shipper Colli 16
Gross Weight (kg) 172.05
Net Weight (kg) 129.26
Warranty period 5 years

Pattern No.	Color	Contract Price	Lead Time
Ready-To-Ship US Warehouse			
MSSTCB2-BRGR	Brown Green	USD 4,510.00	-
MSSTCB2-OAK	Oak	USD 4,510.00	-
MSSTCB2-WHIT	White	USD 4,510.00	-
Ready-To-Ship EU Warehouse			
MSSTCB2-GREY	Grey	USD 4,510.00	-

**STACKED STORAGE SYSTEM / BOOKCASE
- CONFIGURATION 3**

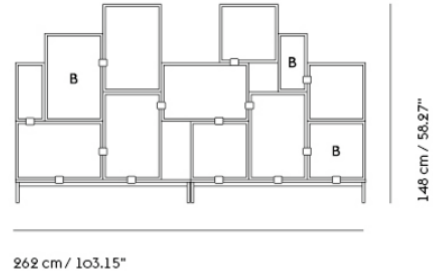
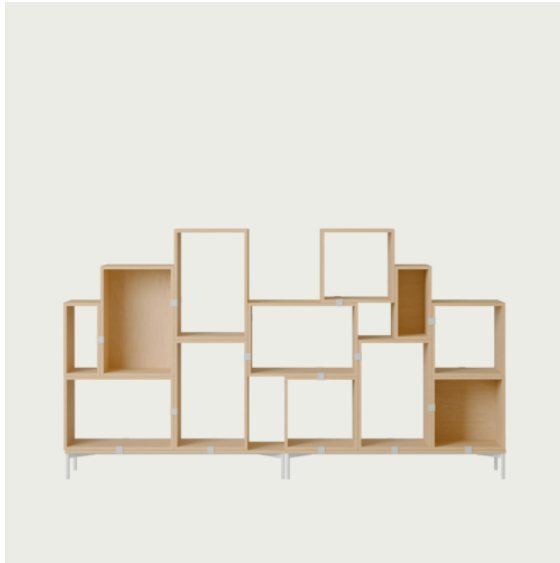

Shipper Colli 17
 Gross Weight (kg) 166.8
 Net Weight (kg) 126.565
 Warranty period 5 years

Pattern No.	Color	Contract Price	Lead Time
Ready-To-Ship US Warehouse			
MSSTCB3-BRGR	Brown Green	USD 5,140.00	-
MSSTCB3-OAK	Oak	USD 5,140.00	-
MSSTCB3-WHIT	White	USD 5,140.00	-
Ready-To-Ship EU Warehouse			
MSSTCB3-GREY	Grey	USD 5,140.00	-

STACKED STORAGE SYSTEM / BOOKCASE - CONFIGURATION 4

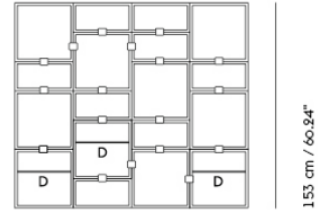
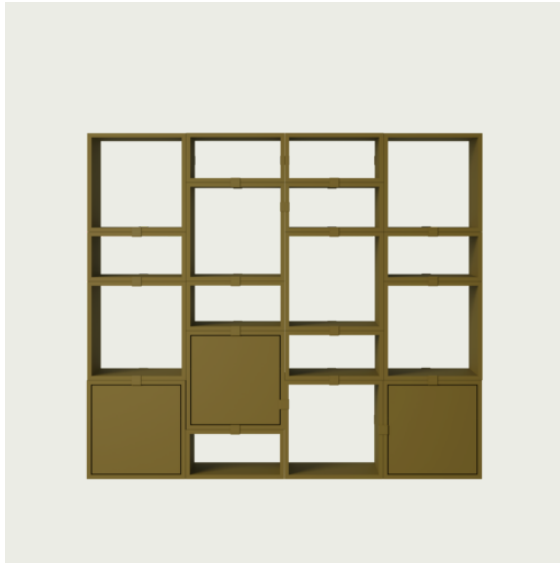

175 cm / 68.9"

Shipper Colli	21
Gross Weight (kg)	184.55
Net Weight (kg)	137.76
Warranty period	5 years

Pattern No.	Color	Contract Price	Lead Time
Ready-To-Ship US Warehouse			
MSSTCB4-BRGR	Brown Green	USD 5,140.00	-
MSSTCB4-OAK	Oak	USD 5,140.00	-
MSSTCB4-WHIT	White	USD 5,140.00	-
Ready-To-Ship EU Warehouse			
MSSTCB4-GREY	Grey	USD 5,140.00	-

STACKED STORAGE SYSTEM / BOOKCASE - CONFIGURATION 5

437

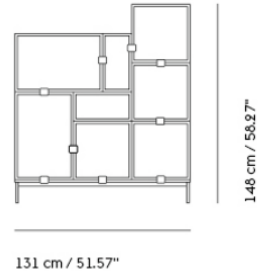
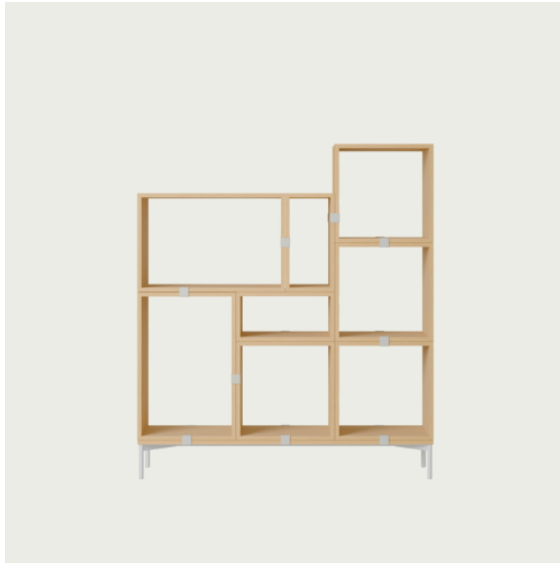

Shipper Colli	10
Gross Weight (kg)	98
Net Weight (kg)	74.33
Warranty period	5 years

Pattern No.	Color	Contract Price	Lead Time
Ready-To-Ship US Warehouse			
MSSTCB5-BRGR	Brown Green	USD 2,886.00	-
MSSTCB5-OAK	Oak	USD 2,886.00	-
MSSTCB5-WHIT	White	USD 2,886.00	-
Ready-To-Ship EU Warehouse			
MSSTCB5-GREY	Grey	USD 2,886.00	-

STACKED STORAGE SYSTEM / BOOKCASE - CONFIGURATION 6

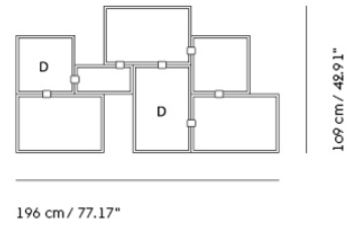
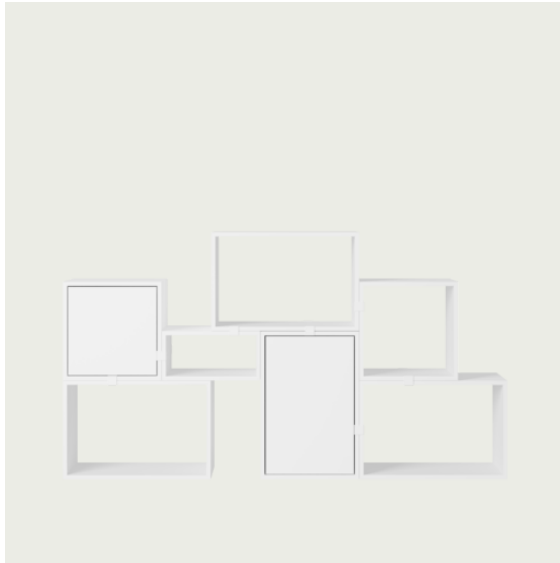

Shipper Colli 7
Gross Weight (kg) 89.75
Net Weight (kg) 67.56
Warranty period 5 years

Pattern No.	Color	Contract Price	Lead Time
Ready-To-Ship US Warehouse			
MSSTCB6-BRGR	Brown Green	USD 2,305.00	-
MSSTCB6-OAK	Oak	USD 2,305.00	-
MSSTCB6-WHIT	White	USD 2,305.00	-
Ready-To-Ship EU Warehouse			
MSSTCB6-GREY	Grey	USD 2,305.00	-

STACKED STORAGE SYSTEM / BOOKCASE - CONFIGURATION 7

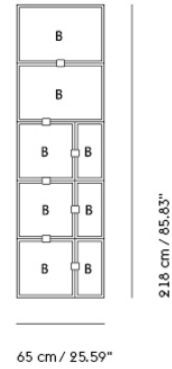

Shipper Colli	8
Gross Weight (kg)	94.85
Net Weight (kg)	69.815
Please note	This is a wall-mounted configuration
Warranty period	5 years

Pattern No.	Color	Contract Price	Lead Time
Ready-To-Ship US Warehouse			
MSSTCB7-BRGR	Brown Green	USD 2,515.00	-
MSSTCB7-OAK	Oak	USD 2,515.00	-
MSSTCB7-WHIT	White	USD 2,515.00	-
Ready-To-Ship EU Warehouse			
MSSTCB7-GREY	Grey	USD 2,515.00	-

STACKED STORAGE SYSTEM / BOOKCASE - CONFIGURATION 8

440

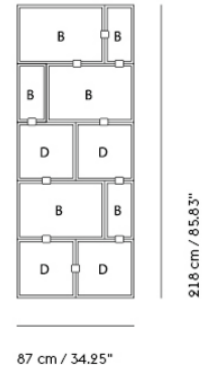

Shipper Colli	10
Gross Weight (kg)	123.6
Net Weight (kg)	91.985
Warranty period	5 years

Pattern No.	Color	Contract Price	Lead Time
Ready-To-Ship US Warehouse			
MSSTCB8-BRGR	Brown Green	USD 3,201.00	-
MSSTCB8-OAK	Oak	USD 3,201.00	-
MSSTCB8-WHIT	White	USD 3,201.00	-
Ready-To-Ship EU Warehouse			
MSSTCB8-GREY	Grey	USD 3,201.00	-

STACKED STORAGE SYSTEM / HALLWAY STORAGE - CONFIGURATION I

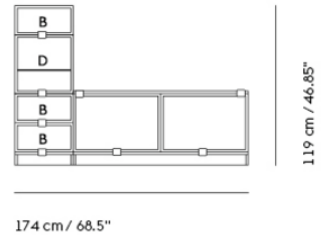
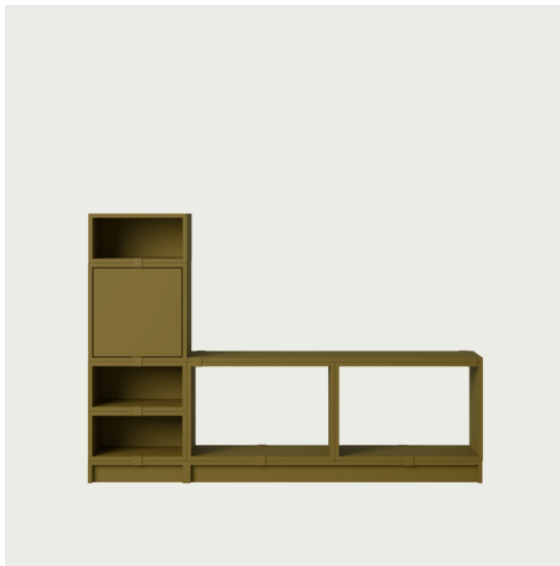

Shipper Colli 13
Gross Weight (kg) 94.1
Net Weight (kg) 68.715
Warranty period 5 years

Pattern No.	Color	Contract Price	Lead Time
Ready-To-Ship US Warehouse			
MSSTCHS1-BRGR	Brown Green	USD 3,250.00	-
MSSTCHS1-OAK	Oak	USD 3,250.00	-
MSSTCHS1-WHIT	White	USD 3,250.00	-
Ready-To-Ship EU Warehouse			
MSSTCHS1-GREY	Grey	USD 3,250.00	-

STACKED STORAGE SYSTEM / HALLWAY STORAGE - CONFIGURATION 2

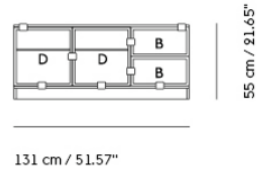

Shipper Colli II
Gross Weight (kg) 66.7
Net Weight (kg) 47.9
Warranty period 5 years

Pattern No.	Color	Contract Price	Lead Time
Ready-To-Ship US Warehouse			
MSSTCHS2-BRGR	Brown Green	USD 2,410.00	-
MSSTCHS2-OAK	Oak	USD 2,410.00	-
MSSTCHS2-WHIT	White	USD 2,410.00	-
Ready-To-Ship EU Warehouse			
MSSTCHS2-GREY	Grey	USD 2,410.00	-

STACKED STORAGE SYSTEM / HALLWAY STORAGE - CONFIGURATION 3

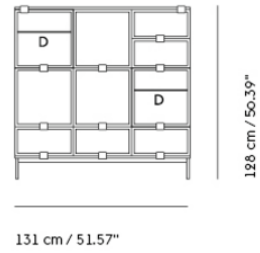

Shipper Colli	17
Gross Weight (kg)	112.85
Net Weight (kg)	84.33
Warranty period	5 years

Pattern No.	Color	Contract Price	Lead Time
Ready-To-Ship US Warehouse			
MSSTCHS3-BRGR	Brown Green	USD 3,985.00	-
MSSTCHS3-OAK	Oak	USD 3,985.00	-
MSSTCHS3-WHIT	White	USD 3,985.00	-
Ready-To-Ship EU Warehouse			
MSSTCHS3-GREY	Grey	USD 3,985.00	-

STACKED STORAGE SYSTEM / HALLWAY STORAGE - CONFIGURATION 4

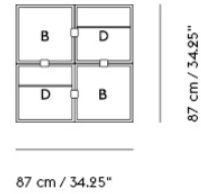
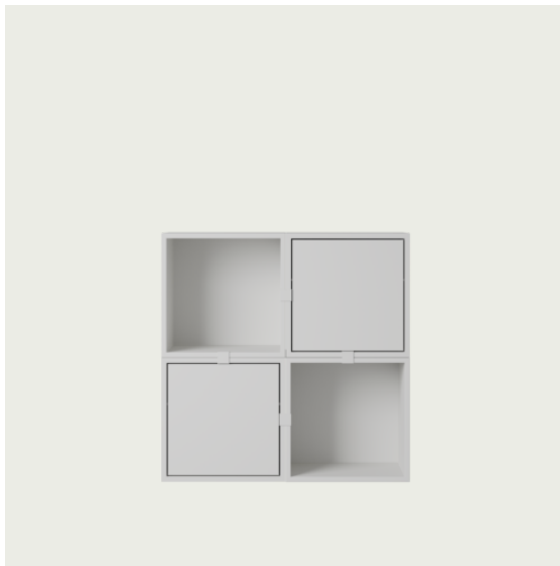

Shipper Colli 6
Gross Weight (kg) 52.7
Net Weight (kg) 38.98
Please note This is a wall-mounted configuration
Warranty period 5 years

Pattern No.	Color	Contract Price	Lead Time
Ready-To-Ship US Warehouse			
MSSTCHS4-BRGR	Brown Green	USD 1,626.00	-
MSSTCHS4-OAK	Oak	USD 1,626.00	-
MSSTCHS4-WHIT	White	USD 1,626.00	-
Ready-To-Ship EU Warehouse			
MSSTCHS4-GREY	Grey	USD 1,626.00	-

STACKED STORAGE SYSTEM / OFFICE STORAGE - CONFIGURATION I

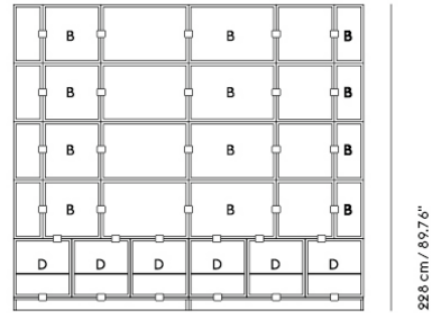
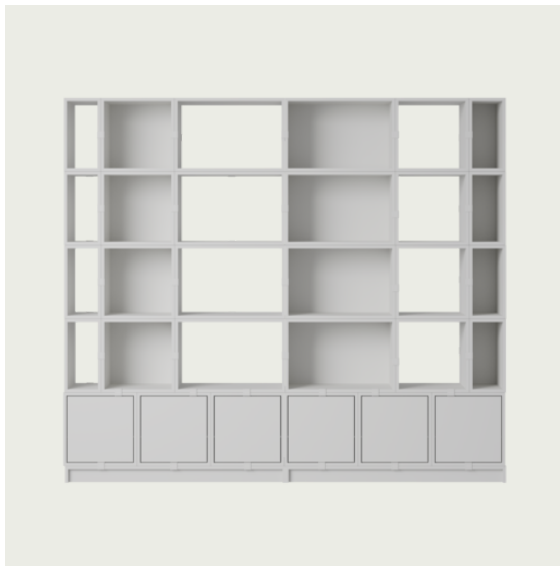

262 cm / 103.15"

Shipper Colli 40
 Gross Weight (kg) 386.6
 Net Weight (kg) 287.66
 Warranty period 5 years

Pattern No.	Color	Contract Price	Lead Time
Ready-To-Ship US Warehouse			
MSSTCOS1-BRGR	Brown Green	USD 11,020.00	-
MSSTCOS1-OAK	Oak	USD 11,020.00	-
MSSTCOS1-WHIT	White	USD 11,020.00	-
Ready-To-Ship EU Warehouse			
MSSTCOS1-GREY	Grey	USD 11,020.00	-

STACKED STORAGE SYSTEM / OFFICE STORAGE - CONFIGURATION 2

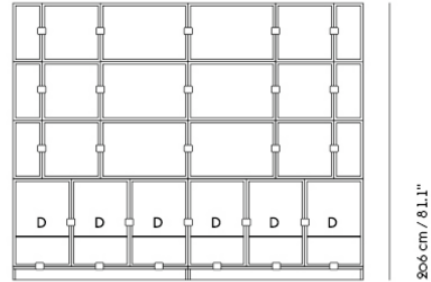

262 cm / 103.15"

Shipper Colli	33
Gross Weight (kg)	334.7
Net Weight (kg)	246.76
Warranty period	5 years

Pattern No.	Color	Contract Price	Lead Time
Ready-To-Ship US Warehouse			
MSSTCOS2-BRGR	Brown Green	USD 9,550.00	-
MSSTCOS2-OAK	Oak	USD 9,550.00	-
MSSTCOS2-WHIT	White	USD 9,550.00	-
Ready-To-Ship EU Warehouse			
MSSTCOS2-GREY	Grey	USD 9,550.00	-

STACKED STORAGE SYSTEM / OFFICE STORAGE - CONFIGURATION 3

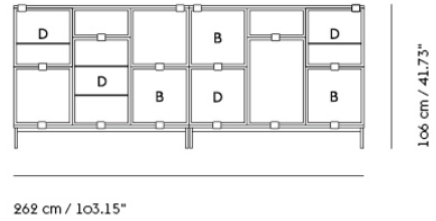

Shipper Colli 27
Gross Weight (kg) 171.45
Net Weight (kg) 127.55
Warranty period 5 years

Pattern No.	Color	Contract Price	Lead Time
Ready-To-Ship US Warehouse			
MSSTCOS3-BRGR	Brown Green	USD 7,240.00	-
MSSTCOS3-OAK	Oak	USD 7,240.00	-
MSSTCOS3-WHIT	White	USD 7,240.00	-
Ready-To-Ship EU Warehouse			
MSSTCOS3-GREY	Grey	USD 7,240.00	-

STACKED STORAGE SYSTEM / OFFICE STORAGE - CONFIGURATION 4

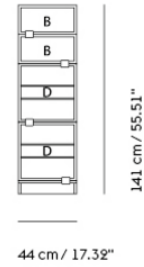

Shipper Colli 9
Gross Weight (kg) 55
Net Weight (kg) 39.41
Warranty period 5 years

Pattern No.	Color	Contract Price	Lead Time
Ready-To-Ship US Warehouse			
MSSTCOS4-BRGR	Brown Green	USD 2,151.00	-
MSSTCOS4-OAK	Oak	USD 2,151.00	-
MSSTCOS4-WHIT	White	USD 2,151.00	-
Ready-To-Ship EU Warehouse			
MSSTCOS4-GREY	Grey	USD 2,151.00	-

STACKED STORAGE SYSTEM / OFFICE STORAGE - CONFIGURATION 5

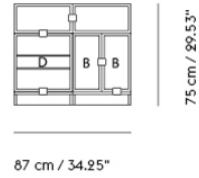

Shipper Colli 9
 Gross Weight (kg) 61
 Net Weight (kg) 44.25
 Warranty period 5 years

Pattern No.	Color	Contract Price	Lead Time
Ready-To-Ship US Warehouse			
MSSTCOS5-BRGR	Brown Green	USD 2,361.00	-
MSSTCOS5-OAK	Oak	USD 2,361.00	-
MSSTCOS5-WHIT	White	USD 2,361.00	-
Ready-To-Ship EU Warehouse			
MSSTCOS5-GREY	Grey	USD 2,361.00	-

STACKED STORAGE SYSTEM / SIDEBORD - CONFIGURATION I

450

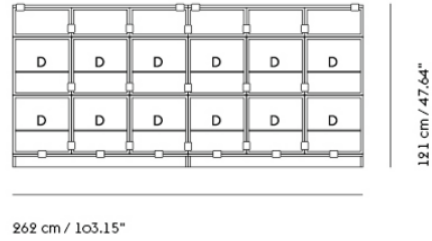
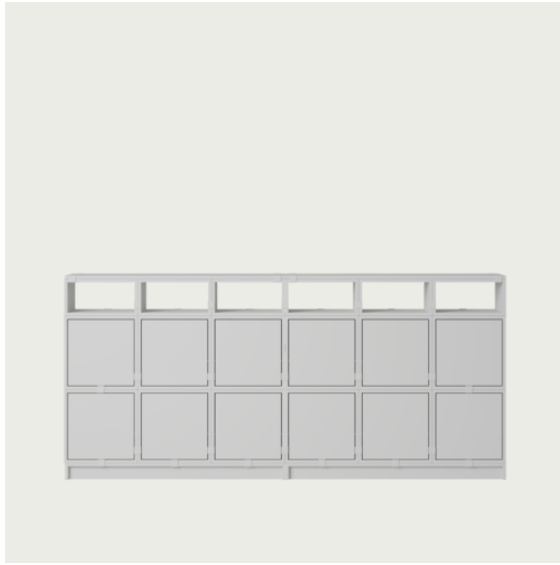

Shipper Colli	28
Gross Weight (kg)	240.2
Net Weight (kg)	178.9
Warranty period	5 years

Pattern No.	Color	Contract Price	Lead Time
Ready-To-Ship US Warehouse			
MSSTCS1-BRGR	Brown Green	USD 8,871.00	-
MSSTCS1-OAK	Oak	USD 8,871.00	-
MSSTCS1-WHIT	White	USD 8,871.00	-
Ready-To-Ship EU Warehouse			
MSSTCS1-GREY	Grey	USD 8,871.00	-

STACKED STORAGE SYSTEM / SIDEBOARD - CONFIGURATION 2

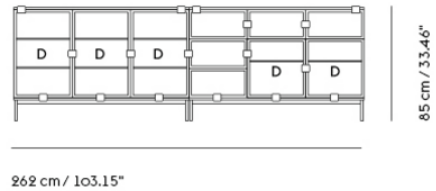

Shipper Colli 30
Gross Weight (kg) 167.3
Net Weight (kg) 121
Warranty period 5 years

Pattern No.	Color	Contract Price	Lead Time
Ready-To-Ship US Warehouse			
MSSTCS2-BRGR	Brown Green	USD 6,351.00	-
MSSTCS2-OAK	Oak	USD 6,351.00	-
MSSTCS2-WHIT	White	USD 6,351.00	-
Ready-To-Ship EU Warehouse			
MSSTCS2-GREY	Grey	USD 6,351.00	-

STACKED STORAGE SYSTEM / SIDEBORD - CONFIGURATION 3

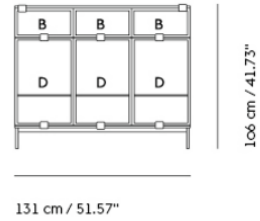

Shipper Colli 15
Gross Weight (kg) 103.2
Net Weight (kg) 73.105
Warranty period 5 years

Pattern No.	Color	Contract Price	Lead Time
Ready-To-Ship US Warehouse			
MSSTCS3-BRGR	Brown Green	USD 3,460.00	-
MSSTCS3-OAK	Oak	USD 3,460.00	-
MSSTCS3-WHIT	White	USD 3,460.00	-
Ready-To-Ship EU Warehouse			
MSSTCS3-GREY	Grey	USD 3,460.00	-

STACKED STORAGE SYSTEM / SIDEBBOARD - CONFIGURATION 4

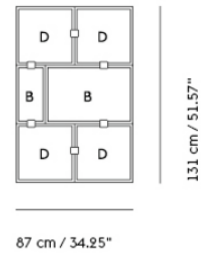

Shipper Colli 6
Gross Weight (kg) 74.8
Net Weight (kg) 55.995
Warranty period 5 years

Pattern No.	Color	Contract Price	Lead Time
Ready-To-Ship US Warehouse			
MSSTCS4-BRGR	Brown Green	USD 2,046.00	-
MSSTCS4-OAK	Oak	USD 2,046.00	-
MSSTCS4-WHIT	White	USD 2,046.00	-
Ready-To-Ship EU Warehouse			
MSSTCS4-GREY	Grey	USD 2,046.00	-

STACKED STORAGE SYSTEM / SIDEBBOARD - CONFIGURATION 5

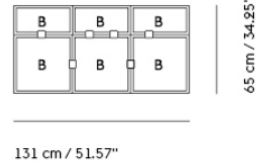
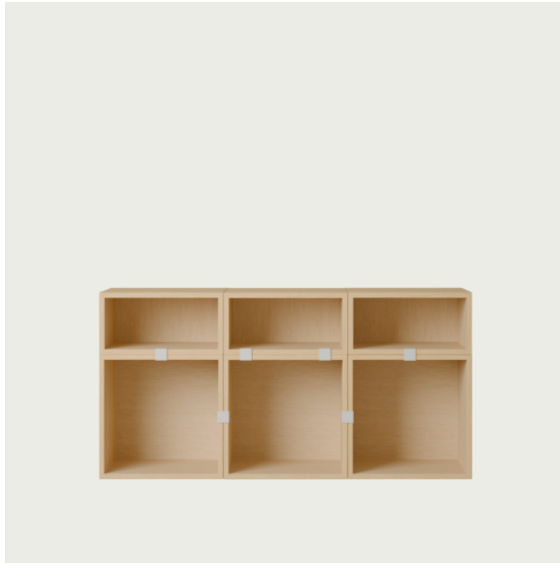

Shipper Colli 6
Gross Weight (kg) 64.65
Net Weight (kg) 46.815
Please note This is a wall-mounted configuration
Warranty period 5 years

Pattern No.	Color	Contract Price	Lead Time
Ready-To-Ship US Warehouse			
MSSTCS5-BRGR	Brown Green	USD 1,731.00	-
MSSTCS5-OAK	Oak	USD 1,731.00	-
MSSTCS5-WHIT	White	USD 1,731.00	-
Ready-To-Ship EU Warehouse			
MSSTCS5-GREY	Grey	USD 1,731.00	-

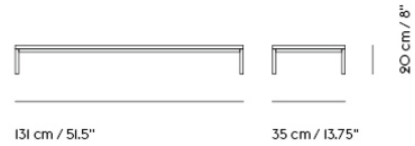

Shipper Colli 1
Gross Weight (kg) 15.5
Net Weight (kg) 12.5
Warranty period 5 years

Pattern No.	Color	Contract Price	Lead Time
Ready-To-Ship US Warehouse			
MSSTP-MBLU	Midnight Blue ***	USD 503.00	-
MSSTP-OAK	Oak ***	USD 503.00	-
MSSTP-WHIT	White	USD 503.00	-

STILL CAFÉ TABLE

FOR MORE INFORMATION,
EXPLORE BELOW

- ↗ [Product Fact Sheet](#)
- ↗ [Images](#)
- ↗ [Architect Files](#)
- ↗ [Assembly Instructions](#)
- ↗ [Product Declaration](#)

STILL CAFÉ TABLE / 75 X 65 H: 73 CM / 29.5 X 25.6 H: 28.7"

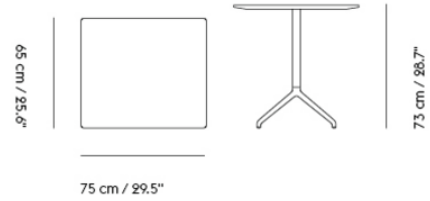

Shipper Colli 2
Gross Weight (kg) 18.3
Net Weight (kg) 13.352
Base color options Black, White
Warranty Period 10 years

Pattern No.	Color	Contract Price	Lead Time
Ready-To-Ship US Warehouse			
MSTLCTR302629N-BLCK-BLCK	Black Nanolaminate/Anthracite Black	USD 923.00	-
MSTLCTR302629N-WHIT-BLCK	Black Nanolaminate/White	USD 923.00	-
MSTLCTR302629N-BLCK-WHIT	White Nanolaminate/Anthracite Black	USD 923.00	-
MSTLCTR302629N-WHIT-WHIT	White Nanolaminate/White	USD 923.00	-
Made-To-Order			
MSTLCTR302629O-BLCK-BLCK	Black Linoleum/Anthracite Black	USD 923.00	-
MSTLCTR302629O-WHIT-BLCK	Black Linoleum/White	USD 923.00	-

STILL CAFÉ TABLE / 75 X 65 H: 95 CM / 29.5 X 25.6 H: 37.4"

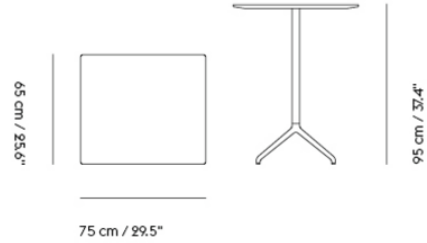

- Shipper Colli 2
- Gross Weight (kg) 18.7
- Net Weight (kg) 13.848
- Base color options White, Black
- Warranty Period 10 years

Pattern No.	Color	Contract Price	Lead Time
Made-To-Order			
MSTLCTR3026380-BLCK-BLCK	Black Linoleum/Anthracite Black	USD 975.00	-
MSTLCTR3026380-WHIT-BLCK	Black Linoleum/White	USD 975.00	-
Made-To-Order			
MSTLCTR302638N-BLCK-BLCK	Black Nanolaminate/Anthracite Black	USD 975.00	-
MSTLCTR302638N-WHIT-BLCK	Black Nanolaminate/White	USD 975.00	-
MSTLCTR302638N-BLCK-WHIT	White Nanolaminate/Anthracite Black	USD 975.00	-
MSTLCTR302638N-WHIT-WHIT	White Nanolaminate/White	USD 975.00	-

STILL CAFÉ TABLE / 75 X 65 H: 105 CM / 29.5 X 25.6 H: 41.3"

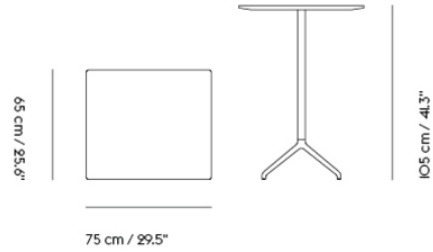

- Shipper Colli 2
- Gross Weight (kg) 19.05
- Net Weight (kg) 14.198
- Base color options White, Black
- Warranty Period 10 years

Pattern No.	Color	Contract Price	Lead Time
Ready-To-Ship US Warehouse			
MSTLCTR302641N-BLCK-BLCK	Black Nanolaminate/Anthracite Black	USD 975.00	-
MSTLCTR302641N-WHIT-BLCK	Black Nanolaminate/White	USD 975.00	-
MSTLCTR302641N-BLCK-WHIT	White Nanolaminate/Anthracite Black	USD 975.00	-
MSTLCTR302641N-WHIT-WHIT	White Nanolaminate/White	USD 975.00	-
Made-To-Order			
MSTLCTR302641O-BLCK-BLCK	Black Linoleum/Anthracite Black	USD 975.00	-
MSTLCTR302641O-WHIT-BLCK	Black Linoleum/White	USD 975.00	-

STILL CAFÉ TABLE / Ø 75 H: 73 CM / Ø 29.5 H: 28.7"

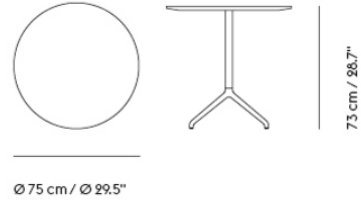

Shipper Colli	2
Gross Weight (kg)	17.1
Net Weight (kg)	12.152
Base color options	Black, White
Warranty Period	10 years

Pattern No.	Color	Contract Price	Lead Time
Ready-To-Ship US Warehouse			
MSTLCTO3029N-BLCK-BLCK	Black Nanolaminate/Anthracite Black	USD 923.00	-
MSTLCTO3029N-WHIT-BLCK	Black Nanolaminate/White	USD 923.00	-
MSTLCTO3029N-BLCK-WHIT	White Nanolaminate/Anthracite Black	USD 923.00	-
MSTLCTO3029N-WHIT-WHIT	White Nanolaminate/White	USD 923.00	-
Made-To-Order			
MSTLCTO30290-BLCK-BLCK	Black Linoleum/Anthracite Black	USD 923.00	-
MSTLCTO30290-WHIT-BLCK	Black Linoleum/White	USD 923.00	-

STILL CAFÉ TABLE / Ø 75 H: 95 CM / Ø 29.5 H: 37.4"

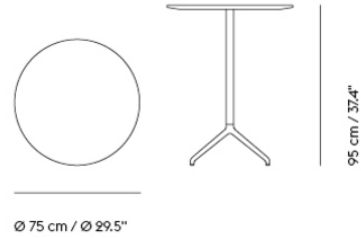

Shipper Colli	2
Gross Weight (kg)	17.5
Net Weight (kg)	12.648
Base color options	Black, White
Warranty Period	10 years

Pattern No.	Color	Contract Price	Lead Time
Made-To-Order			
MSTLCTO30380-BLCK-BLCK	Black Linoleum/Anthracite Black	USD 975.00	-
MSTLCTO30380-WHIT-BLCK	Black Linoleum/White	USD 975.00	-
Made-To-Order			
MSTLCTO3038N-BLCK-BLCK	Black Nanolaminate/Anthracite Black	USD 975.00	-
MSTLCTO3038N-WHIT-BLCK	Black Nanolaminate/White	USD 975.00	-
MSTLCTO3038N-BLCK-WHIT	White Nanolaminate/Anthracite Black	USD 975.00	-
MSTLCTO3038N-WHIT-WHIT	White Nanolaminate/White	USD 975.00	-

STILL CAFÉ TABLE / Ø 75 H: 105 CM / Ø 29.5 H: 41.3"

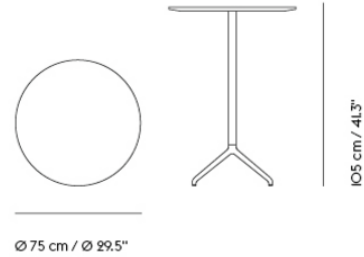

Shipper Colli	2
Gross Weight (kg)	17.85
Net Weight (kg)	12.998
Base color options	Black, White
Warranty Period	10 years

Pattern No.	Color	Contract Price	Lead Time
Ready-To-Ship US Warehouse			
MSTLCTO3041N-BLCK-BLCK	Black Nanolaminate/Anthracite Black	USD 975.00	-
MSTLCTO3041N-WHIT-BLCK	Black Nanolaminate/White	USD 975.00	-
MSTLCTO3041N-BLCK-WHIT	White Nanolaminate/Anthracite Black	USD 975.00	-
MSTLCTO3041N-WHIT-WHIT	White Nanolaminate/White	USD 975.00	-
Made-To-Order			
MSTLCTO3041O-BLCK-BLCK	Black Linoleum/Anthracite Black	USD 975.00	-
MSTLCTO3041O-WHIT-BLCK	Black Linoleum/White	USD 975.00	-

STILL CAFÉ TABLE / Ø 65 H: 73 CM / Ø 25.6 H: 28.7"

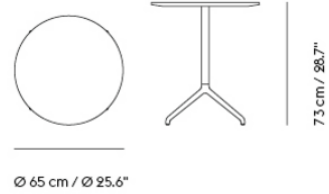

Shipper Colli	2
Gross Weight (kg)	14.7
Net Weight (kg)	10.152
Base color options	Black, White
Warranty Period	10 years

Pattern No.	Color	Contract Price	Lead Time
Made-To-Order			
MSTLCTO26290-BLCK-BLCK	Black Linoleum/Anthracite Black	USD 923.00	-
MSTLCTO26290-WHIT-BLCK	Black Linoleum/White	USD 923.00	-
Made-To-Order			
MSTLCTO2629N-BLCK-BLCK	Black Nanolaminate/Anthracite Black	USD 923.00	-
MSTLCTO2629N-WHIT-BLCK	Black Nanolaminate/White	USD 923.00	-
MSTLCTO2629N-BLCK-WHIT	White Nanolaminate/Anthracite Black	USD 923.00	-
MSTLCTO2629N-WHIT-WHIT	White Nanolaminate/White	USD 923.00	-

STILL CAFÉ TABLE / Ø 65 H: 95 CM / Ø 25.6 H: 37.4"

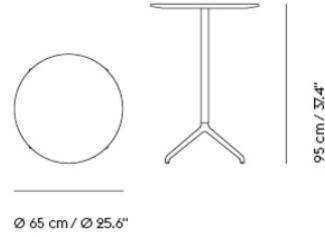

Shipper Colli 2
Gross Weight (kg) 15.1
Net Weight (kg) 10.648
Base color options Black, White
Warranty Period 10 years

Pattern No.	Color	Contract Price	Lead Time
Made-To-Order			
MSTLCTO26380-BLCK-BLCK	Black Linoleum/Anthracite Black	USD 975.00	-
MSTLCTO26380-WHIT-BLCK	Black Linoleum/White	USD 975.00	-
Made-To-Order			
MSTLCTO2638N-BLCK-BLCK	Black Nanolaminate/Anthracite Black	USD 975.00	-
MSTLCTO2638N-WHIT-BLCK	Black Nanolaminate/White	USD 975.00	-
MSTLCTO2638N-BLCK-WHIT	White Nanolaminate/Anthracite Black	USD 975.00	-
MSTLCTO2638N-WHIT-WHIT	White Nanolaminate/White	USD 975.00	-

STILL CAFÉ TABLE / Ø 65 H: 105 CM / Ø 25.6 H: 41.3"

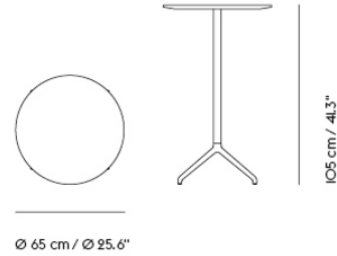

Shipper Colli	2
Gross Weight (kg)	15.45
Net Weight (kg)	10.998
Base color options	Black, White
Warranty Period	10 years

Pattern No.	Color	Contract Price	Lead Time
Made-To-Order			
MSTLCTO2641O-BLCK-BLCK	Black Linoleum/Anthracite Black	USD 975.00	-
MSTLCTO2641O-WHIT-BLCK	Black Linoleum/White	USD 975.00	-
Made-To-Order			
MSTLCTO2641N-BLCK-BLCK	Black Nanolaminate/Anthracite Black	USD 975.00	-
MSTLCTO2641N-WHIT-BLCK	Black Nanolaminate/White	USD 975.00	-
MSTLCTO2641N-BLCK-WHIT	White Nanolaminate/Anthracite Black	USD 975.00	-
MSTLCTO2641N-WHIT-WHIT	White Nanolaminate/White	USD 975.00	-

VISU CHAIR SERIES

FOR MORE INFORMATION,
EXPLORE BELOW

- ↗ [Product Fact Sheet](#)
- ↗ [Images](#)
- ↗ [Architect Files](#)
- ↗ [Assembly Instructions](#)
- ↗ [Product Declaration](#)
- ↗ [Product Configurator](#)

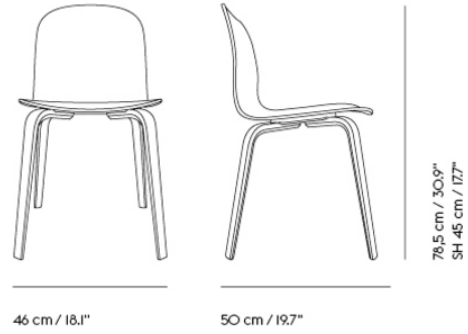

Shipper Colli	1
Gross Weight (kg)	10.2
Net Weight (kg)	4.6125
Base color options	Black, Dark Green, Dusty Green, Grey, Midnight Blue, Oak, Sand or Tan Rose
Warranty Period	5 years

Pattern No.	Color	Contract Price	Lead Time
Ready-To-Ship US Warehouse			
MVISCWODW-BLCK-BLCK	Black/Black	USD 467.00	-
MVISCWODW-DGRN-DGRN	Dusty Green/Dusty Green	USD 467.00	-
MVISCWODW-OAK-OAK	Oak/Oak	USD 467.00	-
MVISCWODW-OAK-WHIT	White/Oak	USD 467.00	-
Ready-To-Ship EU Warehouse			
MVISCWODW-DKGN-DKGN	Dark Green/Dark Green	USD 467.00	-
MVISCWODW-MBLU-MBLU	Midnight Blue/Midnight Blue	USD 467.00	-
MVISCWODW-SAND-SAND	Sand/Sand	USD 467.00	-
MVISCWODW-TROS-TROS	Tan Rose/Tan Rose	USD 467.00	-
Extras			
MGLDVWDFG4	Felt glides for Visu Wood Base (4 pcs per pack) - Grey	USD 21.00	-
MGLDVWDFB4	Felt glides for Visu Wood Base (4 pcs per pack) - Black	USD 21.00	-
MGLDVWDPB4	Plastic Glides for Visu Wood Base (4 pcs per pack) - Black	USD 21.00	-
MLEAKIT	Leather care set for Refine Leather	USD 27.00	-

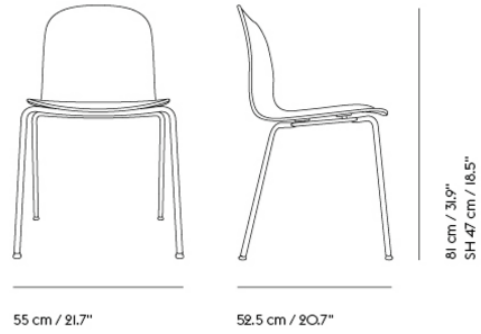

Shipper Colli	1
Gross Weight (kg)	13.5
Net Weight (kg)	5.75
Base color options	Black, Chrome or Grey
Stacking information	Stacking on Trolley: Without upholstery: 17 - With upholstery: 15. Stacking on floor: Without upholstery: 15 - With upholstery: 10.
Warranty Period	10 years

Pattern No.	Color	Contract Price	Lead Time
Ready-To-Ship EU Warehouse			
MVISCTUBW-BLCK-BLCK	Black/Black	USD 394.00	-
Extras			
MGLDOFVTBPB1	Plastic glides for Fiber, Oslo and Visu with Tube Base (1 pc per pack) - Black	USD 6.00	-
MGLDOFVTBFB4	Felt Glides for Fiber, Oslo and Visu with Tube Base (4 pcs per pack)	USD 21.00	-
MCHVST	Chair Hanger for Visu Chair (Sled + Tube base)	USD 93.00	>MOQ: 50 13-15 weeks

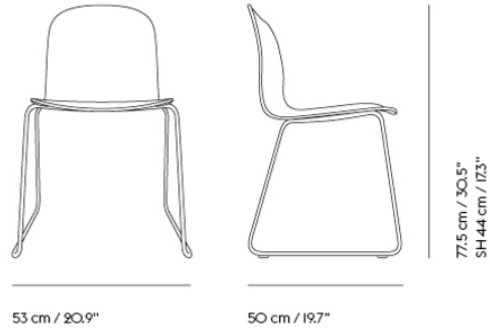

Shipper Colli	1
Gross Weight (kg)	13.5
Net Weight (kg)	5.75
Base color options	Black, Grey or White
Stacking information	Stacking on Trolley: Without upholstery: 17 - With upholstery: 15. Stacking on floor: Without upholstery: 15 - With upholstery: 10
Warranty Period	10 years

Pattern No.	Color	Contract Price	Lead Time
-------------	-------	----------------	-----------

Ready-To-Ship US Warehouse

MVISCSLDW-BLCK-BLCK	Black/Black	USD 394.00	-
MVISCSLDW-WHIT-WHIT	White/White ***	USD 394.00	-

Extras

MGLDFVSDFT1	Felt Glides for Fiber and Visu with Sled Base (1 pc per pack)	USD 6.00		-
MLDVSLD	Linking Device for Visu Chair Sled Base	USD 48.00	>MOQ: 8	13-15 weeks
MCHVST	Chair Hanger for Visu Chair (Sled + Tube base)	USD 93.00	>MOQ: 50	13-15 weeks

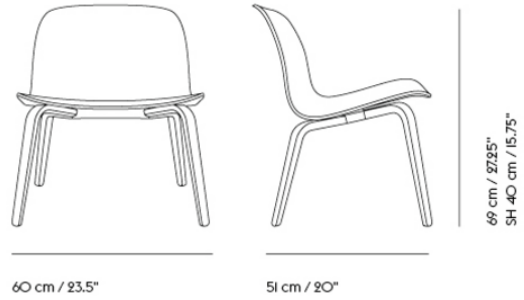

Shipper Colli	1
Gross Weight (kg)	11.5
Net Weight (kg)	9.224
Base color options	Black, Dusty Green, Grey or Oak
Warranty Period	5 years

Pattern No.	Color	Contract Price	Lead Time
Ready-To-Ship US Warehouse			
MVISLW-BLCK-BLCK	Black/Black	USD 667.00	-
MVISLW-GREY-GREY	Grey/Grey - PU Lacquer	USD 667.00	-
MVISLW-OAK-OAK	Oak/Oak	USD 667.00	-
MVISLU-OAK-M155991	Fiord 991/Oak	USD 1,024.00	-
MVISLU-GREY-M4586108	Re-wool IO8/ Grey	USD 1,024.00	-
MVISLU-OAK-M136COGN	Refine Leather Cognac/Oak	USD 1,675.00	-
Ready-To-Ship EU Warehouse			
MVISLW-DGRN-DGRN	Dusty Green/Dusty Green	USD 667.00	-
Extras			
MGLDVWDFG4	Felt glides for Visu Wood Base (4 pcs per pack) - Grey	USD 21.00	-
MGLDVWDFB4	Felt glides for Visu Wood Base (4 pcs per pack) - Black	USD 21.00	-
MGLDVWDPB4	Plastic Glides for Visu Wood Base (4 pcs per pack) - Black	USD 21.00	-
MLEAKIT	Leather care set for Refine Leather	USD 27.00	-

VISU COUNTER STOOL WOOD BASE - 65 CM / 25.6"

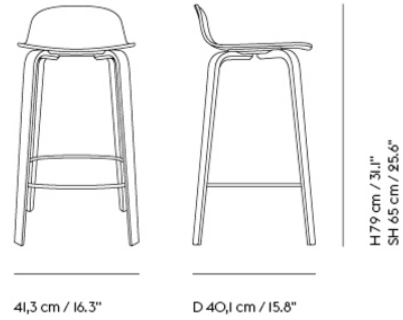

Shipper Colli	1
Gross Weight (kg)	5.6
Net Weight (kg)	4.08
Base color options	Black, Dark Green, Grey, Oak or Tan Rose
Warranty Period	5 years

Pattern No.	Color	Contract Price	Lead Time
Ready-To-Ship US Warehouse			
MVISSTCW-BLCK-BLCK	Black/Black	USD 719.00	-
MVISSTCW-GREY-GREY	Grey/Grey	USD 719.00	-
MVISSTCW-OAK-OAK	Oak/Oak	USD 719.00	-
Ready-To-Ship EU Warehouse			
MVISSTCW-OAK-WHIT	White/Oak	USD 719.00	-
Extras			
MGLDVWDFG4	Felt glides for Visu Wood Base (4 pcs per pack) - Grey	USD 21.00	-
MGLDVWDFB4	Felt glides for Visu Wood Base (4 pcs per pack) - Black	USD 21.00	-
MGLDVWDPB4	Plastic Glides for Visu Wood Base (4 pcs per pack) - Black	USD 21.00	-
MLEAKIT	Leather care set for Refine Leather	USD 27.00	-

VISU BAR STOOL WOOD BASE - 75 CM / 29.5"

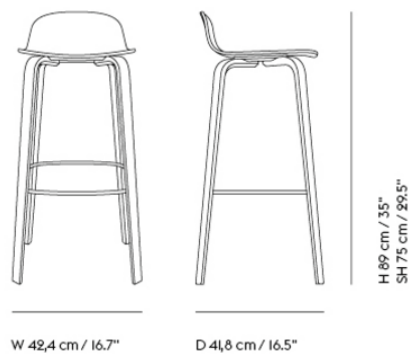

Shipper Colli	1
Gross Weight (kg)	5.7
Net Weight (kg)	4.18
Base color options	Black, Dark Green, Grey, Oak or Tan Rose
Warranty Period	5 years

Pattern No.	Color	Contract Price	Lead Time
Ready-To-Ship US Warehouse			
MVISSTBW-BLCK-BLCK	Black/Black	USD 719.00	-
MVISSTBW-GREY-GREY	Grey/Grey	USD 719.00	-
MVISSTBW-OAK-OAK	Oak/Oak ***	USD 719.00	-
MVISSTBW-TROS-TROS	Tan Rose/Tan Rose	USD 719.00	-
Ready-To-Ship EU Warehouse			
MVISSTBW-OAK-WHIT	White/Oak	USD 719.00	-
Extras			
MGLDVWDFG4	Felt glides for Visu Wood Base (4 pcs per pack) - Grey	USD 21.00	-
MGLDVWDFB4	Felt glides for Visu Wood Base (4 pcs per pack) - Black	USD 21.00	-
MGLDVWDPB4	Plastic Glides for Visu Wood Base (4 pcs per pack) - Black	USD 21.00	-
MLEAKIT	Leather care set for Refine Leather	USD 27.00	-

COVER AND VISU CHAIR TRANSPORT TROLLEY

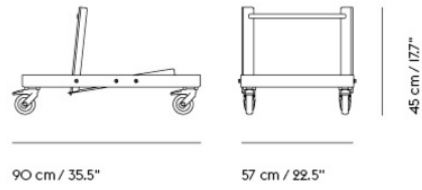

Shipper Colli	1
Gross Weight (kg)	22
Net Weight (kg)	21.5
Please note	This transport trolley can be used for Visu Chair Tube Base, Visu Chair Sled Base and Cover Side Chair.
Stacking information	Cover Side Chair (10 pcs.) / Visu Chair Sled Base (17 pcs.) / Visu Chair Tube Base (17 pcs.) / Visu Chair Sled Base w. Upholstery (15 pcs.) / Visu Chair Tube Base w. Upholstery (15 pcs)
Warranty Period	5 years

Pattern No.	Color	Contract Price	Lead Time
Ready-To-Ship US Warehouse			
MTTCV	Black	USD 971.00	-

VISU CHAIR WOOD BASE & VISU LOUNGE CHAIR



78,5 cm / 31"
SH 46 cm / 18"

46 cm / 18"

51 cm / 20"



69 cm / 27.25"
SH 40 cm / 15.75"

60 cm / 23.5"

51 cm / 20"

All Upholstery Variants

Description	Pattern No.	Upholstery Grades	COM		CIL		COL				
			A	B	C	E	R	T	U	V	W
Visu Chair Wood Base Upholstered Seat	M-VISC-WOD-U		719	786	849	881	933	1,101	1,045	1,416	1,570
Visu Lounge Chair Upholstered Seat	M-VISL-U		919	1,024	1,101	1,150	1,626	1,675	1,675	2,361	2,515

HOW TO CONFIGURE

Specify:

- Step 1) Choose variant
- Step 2) Choose base color
- Step 3) Choose textile
- Step 4) Choose textile color

ORDER CODE EXAMPLE:

Visu Lounge Chair upholstered in beige Endure Leather

Variant	Visu Lounge Chair	M-VISL-U
Base color	Oak	OAK
Upholstery option	Endure Leather	M137
Upholstery color	Beige	BEIG
Final Pattern No:		MVISLUOAKM137BEIG

Base Color Options

Visu Chair - wood base:
OAK - Oak
BLCK - Black
GREY - Grey
DKGN - Dark Green
TROS - Tan Rose

Visu Lounge Chair - wood base:
OAK - Oak
BLCK - Black
GREY - Grey
DGRN - Dusty Green

Upholstery Options

A	B	C	E	R	T	U	V	W
Ocean (M161)* Remix (M156)	Beck (M6376) Canvas (M153) Clara (M154) Fiord (M155) Grain (M12659) Manner (M12665) Re-Wool (M4586) Sabi (M8404) Steelcut (M149) Steelcut Trio (M139)	Hallingdal (M146)	Acca (M12660) Balder (M152) Divina (M150) Divina MD (M147) Divina Melange (M135) Ecriture (M10767) Hearth (M12664) Twill Weave (M142) Vidar (M158)	Easy Leather (M141)	Refine Leather (M136)	Endure Leather (M137)	Grace Leather (M12374)	Allure Leather (M12375)

*Notes:
Ocean - Color 3, 21, 32, 50, 52, 80 & 601

VISU CHAIR TUBE & SLED BASE



78 cm / 30.75"
SH 46 cm / 18"



78 cm / 30.75"
SH 46 cm / 18"

53,5 cm / 21"

50 cm / 19.75"

53,5 cm/21"

48 cm / 19"

All Variants

	Description	Pattern No.	W1	Upholstery Grades				
				A	COM B	CIL C	E	R
Visu Chair Tube Base	Wood Seat	M-VISC-TUB-W	394					
	Upholstered Seat	M-VISC-TUB-U		576	614	681	719	776
Visu Chair Tube Base w Linking Device	Wood Seat	M-VISC-TUB-W-LD	440					
	Upholstered Seat	M-VISC-TUB-U-LD		625	660	730	772	824
Visu Chair Sled Base	Wood Seat	M-VISC-SLD-W	394					
	Upholstered Seat	M-VISC-SLD-U		562	614	681	719	776
Visu Chair Sled Base w Linking Device	Wood Seat	M-VISC-SLD-W-LD	440					
	Upholstered Seat	M-VISC-SLD-U-LD		625	660	730	772	824

HOW TO CONFIGURE

ORDER CODE EXAMPLE:

Specify:

Visu Chair Black Sled Base upholstered in Divina Melange 277

- Step 1) Choose variant
- Step 2) Choose base color
- Step 3) Choose textile
- Step 4) Choose textile color

Variant: Visu Chair Sled Base
 Base color: Black
 Upholstery option: Endure Leather
 Upholstery color: 277
 Final Pattern No: M-VISC-SLD-U
 M-VISC-SLD-U
 BLCK
 M135
 277
 MVISCSLDUBLCKM135277

Base Color Options

Shell Color Options

When ordering wood shell version

Tube base
 BLCK - Black
 GREY - Grey
 CHRO - Chrome

Tube base
 OAK - Oak (W1)
 BLCK - Black (W1)
 GREY - Grey (W1)

Base and wood shell can be combined as follows
 Tube Base
 BLCK/BLCK - Black/Black Shell
 GREY/GREY - Grey/Grey Shell
 CHRO/OAK - Chrome/Oak Shell

Sled base
 BLCK - Black
 GREY - Grey
 WHIT - White

Sled base
 WHIT - White (W1)
 BLCK - Black (W1)

Sled base
 BLCK/BLCK - Black/Black Shell
 GREY/GREY - Grey/Grey Shell
 WHIT/WHIT - White/White Shell

Upholstery Options

A	B	C	E	R
Ocean (M161)* Remix (M156)	Beck (M6376) Canvas (M153) Clara (M154) Fiord (M155) Grain (M12659) Manner (M12665) Re-Wool (M4586) Sabi (M8404) Steelcut (M149) Steelcut Trio (M139)	Hallingdal (M146)	Acca (M12660) Balder (M152) Divina (M150) Divina MD (M147) Divina Melange (M135) Ecriture (M01767) Hearth (M12664) Twill Weave (M142)	Easy Leather (M141)

*Notes:
 *Ocean: Color 3, 21, 32, 50, 52, 80 & 601

VISU WIDE CHAIR WOOD & SWIVEL BASE

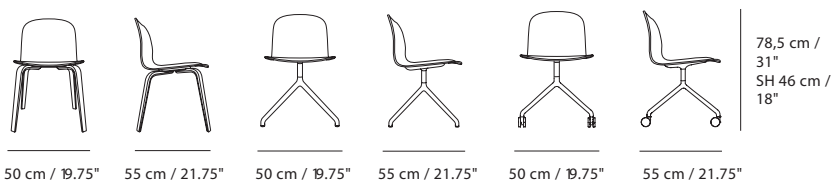

Wood base:
Gross Weight (kg) 4.9
Net Weight (kg) 4.6
Warranty Period 5 years

Swivel base & Swivel base w/castors:
Gross Weight (kg) 7.8
Net Weight (kg) 7.6
Warranty Period 5 years

All Variants

			Upholstery Grades									
			COM			CIL			COL			
	Description	Pattern No.	W1	A	B	C	E	R	T	U	V	W
Visu Wide Chair Wood	Wood Seat	M-VISWC-WOD-W	541									
Base	Upholstered Seat	M-VISWC-WOD-U		807	881	933	971	1,024	1,150	1,206	1,836	2,046
Visu Wide Chair Swivel	Wood Seat	M-VISWC-SWB-W	702									
Base	Upholstered Seat	M-VISWC-SWB-U		971	1,101	1,101	1,150	1,255	1,311	1,360	2,046	2,256
Visu Wide Chair Swivel	Wood Seat	M-VISWC-SWR-W	776									
Base w. Return	Upholstered Seat	M-VISWC-SWR-U		1,045	1,150	1,206	1,206	1,311	1,311	1,416	2,046	2,256
Visu Wide Chair Swivel	Wood Seat	M-VISWC-SWC-W	776									
Base w. Castors	Upholstered Seat	M-VISWC-SWC-U		1,045	1,150	1,206	1,206	1,255	1,416	1,416	2,095	2,305

HOW TO CONFIGURE

ORDER CODE EXAMPLE:

Specify:

Visu Chair Black Sled Base upholstered in Divina Melange 277

Step 1) Choose Variant
Step 2) Base color
Step 3) Textile
Step 4) Textile color

Variant: Visu Chair Sled Base
Base Color: Black
Upholstery option: Endure Leather
Upholstery Color: 277
Final Pattern No.: MVISCSLDUBLCKM135277

Base Color Options

Shell Color Options

When ordering wood shell version

Swivel base & Swivel base w. Return
BLCK - Black

OAK - Oak (W1)
BLCK - Black (W1)

Base and Shell can be combined as follows
Wood base
OAK/OAK - Oak/Oak Shell
BLCK/BLCK - Black/Black Shell

Swivel base w. Castors
BLCK - Black with black castors

Wood base:
OAK - Oak
BLCK - Black

All Swivel bases
BLCK/BLCK - Black/Black Shell
BLCK/OAK - Black/Oak Shell

Upholstery Options

A	B	C	E	R	T	U	V	W
Ocean (M161)* Remix (M156)	Beck (M6376) Canvas (M153) Clara (M154) Fiord (M155) Grain (M12659) Manner (M12665) Re-Wool (M4586) Sabi (M8404) Steelcut (M149) Steelcut Trio (M139)	Hallingdal (M146)	Acca (M12660) Balder (M152) Divina (M150) Divina MD (M147) Divina Melange (M135) Ecriture (M10767) Hearth (M12664) Twill Weave (M142) Vidar (M158)	Easy Leather (M141)	Refine Leather (M136)	Endure Leather (M137)	Grace Leather (M12374)	Allure Leather (M12375)

*Notes:
Ocean - Color 3, 21, 32, 50, 52, 80 & 601



All Upholstery Variants

Description	Pattern No.	Upholstery Grades									
		A	COM	CIL	E	R	COL	U	V	W	
Visu Counter Upholstered Seat	M-VISST-C-U	866	902	1,013	995	1,045	1,101	1,101	1,465	1,570	
Visu Bar Stool Upholstered Seat	M-VISST-B-U	866	902	1,013	995	1,045	1,101	1,101	1,465	1,570	

HOW TO CONFIGURE

ORDER CODE EXAMPLE:

Specify:	Visu Counter Stool upholstered in beige Endure Leather		
Step 1) Choose variant	Variant	Visu Counter Stool	M-VISST-C-U
Step 2) Choose color	Base Color	Oak	OAK
Step 3) Choose Textile	Upholstery option	Endure Leather	M137
Step 4) Choose Textile color	Upholstery Color	Beige	BEIG
	Final Pattern No:		MVISSTCUOAKM137BEIG

Base Color Options

- OAK - Oak
- BLCK - Black
- GREY - Grey
- DKGN - Dark Green
- TROS - Tan Rose

Upholstery Options

A	B	C	E	R	T	U	V	W
Ocean (M161)* Remix (M156)	Beck (M6376) Canvas (M153) Clara (M154) Fiord (M155) Grain (M12659) Manner (M12665) Re-Wool (M4586) Sabi (M8404) Steelcut (M149) Steelcut Trio (M139)	Hallingdal (M146)	Acca (M12660) Balder (M152) Divina (M150) Divina MD (M147) Divina Melange (M135) Ecriture (M10767) Hearth (M12664) Twill Weave (M142) Vidar (M158)	Easy Leather (M141)	Refine Leather (M136)	Endure Leather (M137)	Grace Leather (M12374)	Allure Leather (M12375)

*Notes:
Ocean - Color 3, 21, 32, 50, 52, 80 & 601

WORKSHOP SERIES

FOR MORE INFORMATION,
EXPLORE BELOW

- ↗ [Product Fact Sheet](#)
- ↗ [Images](#)
- ↗ [Architect Files](#)
- ↗ [Assembly Instructions](#)
- ↗ [Product Declaration](#)

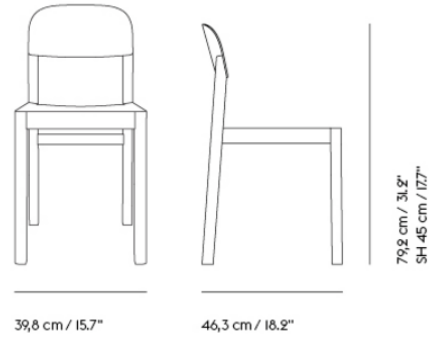

Shipper Colli I
 Gross Weight (kg) 11
 Net Weight (kg) 5.095
 Warranty Period 5 years

Pattern No.	Color	Contract Price	Lead Time
Ready-To-Ship US Warehouse			
MWRKCW-BLCK	Black	USD 597.00	-
MWRKCW-OAK	Oak	USD 597.00	-

WORKSHOP TABLE / 130 X 65 CM / 51 X 25.5"

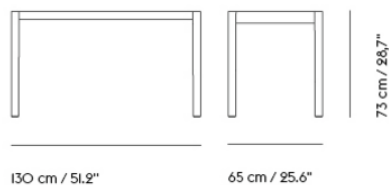
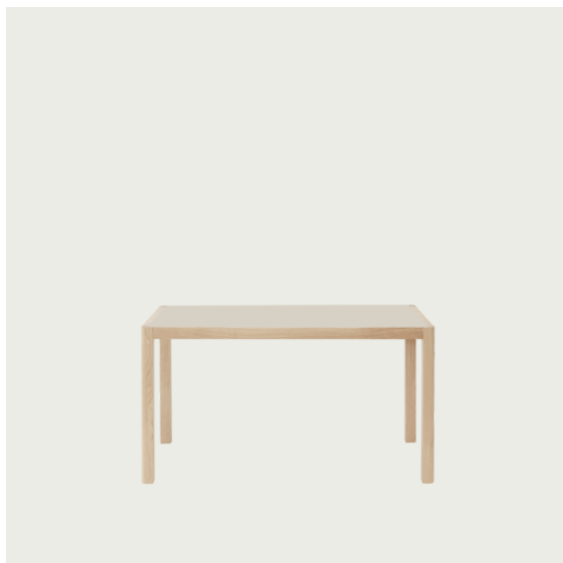

Shipper Colli	1
Gross Weight (kg)	26.25
Net Weight (kg)	22.5
Warranty Period	10 years

Pattern No.	Color	Contract Price	Lead Time
Ready-To-Ship US Warehouse			
MWRKDT5126-BLCK-BLCK	Black Linoleum/Black	USD 2,256.00	-
MWRKDT5126-WMGY-OAK	Warm Grey Linoleum/Oak	USD 2,256.00	-
Extras			
MTWRKDTSCRK-BLCK	Screw Kit for Workshop Table	USD 23.00	-

WORKSHOP TABLE / 140 X 92 CM / 55.1 X 36.2"

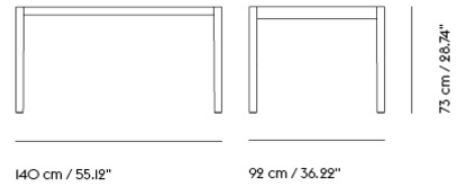

Shipper Colli 1
Gross Weight (kg) 30
Net Weight (kg) 25.95
Warranty Period 10 years

Pattern No.	Color	Contract Price	Lead Time
Ready-To-Ship EU Warehouse			
MWRKDT5536-OAK	Oak Veneer/Oak	USD 2,781.00	-
MWRKDT5536-BLCK-BLCK	Black Linoleum/Black	USD 2,571.00	-
MWRKDT5536-WMGY-OAK	Warm Grey Linoleum/Oak	USD 2,571.00	-
Extras			
MTWRKDTSCRK-BLCK	Screw Kit for Workshop Table	USD 23.00	-

WORKSHOP TABLE / 200 X 92 CM / 78.7 X 36.2"

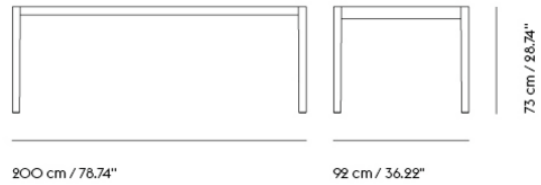

Shipper Colli | 1
Gross Weight (kg) | 44
Net Weight (kg) | 39.55
Warranty Period | 10 years

Pattern No.	Color	Contract Price	Lead Time
Ready-To-Ship EU Warehouse			
MWRKDT7836-OAK	Oak Veneer/Oak	USD 3,516.00	-
MWRKDT7836-BLCK-BLCK	Black Linoleum/Black	USD 3,306.00	-
MWRKDT7836-WMGY-OAK	Warm Grey Linoleum/Oak	USD 3,306.00	-
Extras			
MTWRKDTSCRK-BLCK	Screw Kit for Workshop Table	USD 23.00	-

**WORKSHOP COFFEE TABLE / 120 X 43 CM
/ 47.2" X 16.9"**

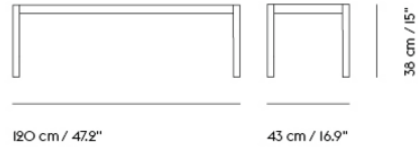

Shipper Colli 1
 Gross Weight (kg) 10.5
 Net Weight (kg) 8.46
 Warranty Period 5 years

Pattern No.	Color	Contract Price	Lead Time
Ready-To-Ship US Warehouse			
MWRKCT4717-BOAK	Black	USD 866.00	-
MWRKCT4717-OAK	Oak Veneer/Oak	USD 866.00	-
MWRKCT4717-BLCK	Black Linoleum/Black	USD 845.00	-
MWRKCT4717-WMGY	Warm Grey Linoleum/Oak	USD 845.00	-
Extras			
MTWRKDTSCRK-BLCK	Screw Kit for Workshop Table	USD 23.00	-

WORKSHOP COFFEE TABLE / 86 X 86 CM / 33.9" X 33.9"

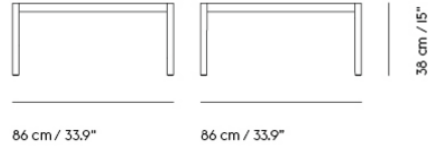

Shipper Colli 1
Gross Weight (kg) 11.8
Net Weight (kg) 9.22
Warranty Period 10 years

Pattern No.	Color	Contract Price	Lead Time
Ready-To-Ship US Warehouse			
MWRKCT3434-BOAK	Black	USD 1,101.00	-
MWRKCT3434-OAK	Oak Veneer/Oak	USD 1,101.00	-
MWRKCT3434-BLCK	Black Linoleum/Black	USD 1,028.00	-
MWRKCT3434-WMGY	Warm Grey Linoleum/Oak	USD 1,028.00	-
Extras			
MTWRKDTSCRK-BLCK	Screw Kit for Workshop Table	USD 23.00	-

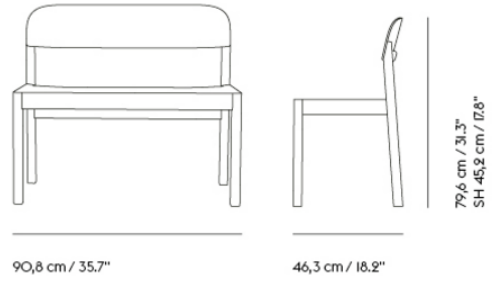

Shipper Colli 1
 Gross Weight (kg) 12.76
 Net Weight (kg) 9.49
 Warranty Period 5 years

Pattern No.	Color	Contract Price	Lead Time
Ready-To-Ship EU Warehouse			
MWRKBW-BLCK	Black	USD 1,360.00	-
MWRKBW-OAK	Oak	USD 1,360.00	-

WRAP LOUNGE CHAIR

FOR MORE INFORMATION,
EXPLORE BELOW

- [↗ Product Fact Sheet](#)
- [↗ Images](#)
- [↗ Architect Files](#)
- [↗ Product Declaration](#)
- [↗ Product Configurator](#)

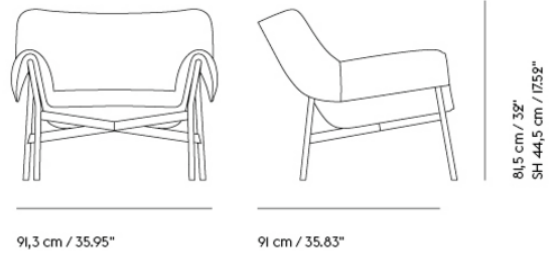

Shipper Colli	1
Gross Weight (kg)	45
Net Weight (kg)	40
Base color options	Grey or Black
Warranty Period	10 years

Pattern No.	Color	Contract Price	Lead Time
Ready-To-Ship US Warehouse			
MWRPLC-BLCK-M8404151	Sabi 151/Black ***	USD 3,096.00	-
MWRPLC-GREY-M10767240	Ecriture 240/Grey	USD 3,355.00	-



WRAP LOUNGE CHAIR

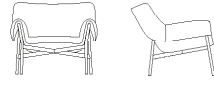

91 cm /
35.8"
SH 44.5 cm /
17.5"

81 cm / 31.9" 91.3 cm / 35.9"

Tube Base
Shipper Coll: 1
Gross Weight (kg): 45
Net Weight (kg): 40
Warranty Period: 10 years

All Upholstery Variants

All Variants

	Pattern No.	Upholstery Grades			
		A	COM	CIL	E
Wrap Lounge Chair	MWRPLC	2,676	3,096	3,201	3,355

HOW TO CONFIGURE

Specify:

- Step 1: Choose variant
- Step 2: Choose base color
- Step 3: Choose textile
- Step 4: Choose textile color

ORDER CODE EXAMPLE

Oslo Lounge Chair Tube Base in Colline 227

Variant	Wrap Lounge Chair
Base Color	Black
Textile	Colline
Textile Color	227
Final Pattern No:	MWRPLCBLCKM5416227

Base Finish Options

- BLCK - Black
- GREY - Grey

UPHOLSTERY OPTIONS

A	B	C	E
Ocean (M161)* Remix (M156)	Beck (M6376) Canvas (M153) Clara (M154) Fiord (M155) Grain (M12659) Manner (M12665) Re-Wool (M4586) Sabi (M8404) Steelcut (M149) Steelcut Trio (M139)	Hallingdal (M146)	Acca (M12660) Divina (M150) Divina MD (M147) Divina Melange (M135) Ecriture (M10767) Hearth (M12664) Twill Weave (M142) Vidar (M158)

*Notes:
Ocean - Color 3, 21, 32, 50, 52, 80 & 601

LIGHTING

AMBIT LAMP SERIES

FOR MORE INFORMATION,
EXPLORE BELOW

- ↗ [Product Fact Sheet](#)
- ↗ [Images](#)
- ↗ [Architect Files](#)
- ↗ [Assembly Instructions](#)
- ↗ [Product Declaration](#)
- ↗ [Lighting Files](#)



Shipper Colli 1
Gross Weight (kg) 1.0002
Net Weight (kg) 0.69
Bulb included EU version: yes, US version: no
Warranty Period 5 years

Pattern No.	Color	Contract Price	Lead Time
Ready-To-Ship US Warehouse			
MAMBPDLP06-BLCK	Black	USD 299.00	-
MAMBPDLP06-DGRN	Dusty Green	USD 299.00	-
MAMBPDLP06-GREY	Grey	USD 299.00	-
MAMBPDLP06-LTBU	Light Blue	USD 299.00	-
MAMBPDLP06-TAUP	Taupe	USD 299.00	-
MAMBPDLP06-WHIT	White	USD 299.00	-
Extras			
MLPCAPL	Ceiling Cap - White	USD 28.00	-

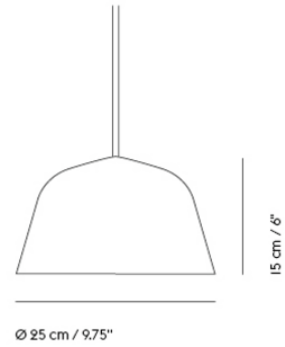

Shipper Colli 1
Gross Weight (kg) 1.1092
Net Weight (kg) 0.7
Bulb included No
Warranty Period 5 years

Pattern No.	Color	Contract Price	Lead Time
Ready-To-Ship US Warehouse			
MAMBPDLP09-BLCK	Black	USD 419.00	-
MAMBPDLP09-DGRN	Dusty Green	USD 419.00	-
MAMBPDLP09-GREY	Grey	USD 419.00	-
MAMBPDLP09-LTBU	Light Blue	USD 419.00	-
MAMBPDLP09-ROS	Rose	USD 419.00	-
MAMBPDLP09-TAUP	Taupe	USD 419.00	-
MAMBPDLP09-WHIT	White	USD 419.00	-
Extras			
MLPCAPL	Ceiling Cap - White	USD 28.00	-

AMBIT PENDANT LAMP / Ø 40 CM / 15.75"

493

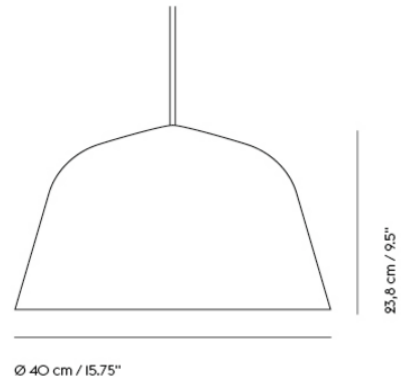

Shipper Colli	1
Gross Weight (kg)	2.9002
Net Weight (kg)	1.53
Bulb included	No
Warranty Period	5 years

Pattern No.	Color	Contract Price	Lead Time
Ready-To-Ship US Warehouse			
MAMBPDLP15-BLCK	Black	USD 671.00	-
MAMBPDLP15-DGRN	Dusty Green	USD 671.00	-
MAMBPDLP15-GREY	Grey	USD 671.00	-
MAMBPDLP15-LTBU	Light Blue	USD 671.00	-
MAMBPDLP15-ROS	Rose	USD 671.00	-
MAMBPDLP15-TAUP	Taupe	USD 671.00	-
MAMBPDLP15-WHIT	White	USD 671.00	-
Extras			
MLPCAPL	Ceiling Cap - White	USD 28.00	-

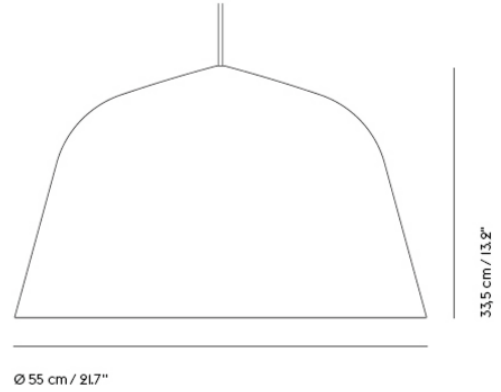

Shipper Colli	1
Gross Weight (kg)	5.585
Net Weight (kg)	2.7
Bulb included	No
Warranty Period	5 years

Pattern No.	Color	Contract Price	Lead Time
Ready-To-Ship US Warehouse			
MAMBPDLP22-BLCK	Black	USD 1,007.00	-
MAMBPDLP22-DGRN	Dusty Green	USD 1,007.00	-
MAMBPDLP22-GREY	Grey	USD 1,007.00	-
MAMBPDLP22-LTBU	Light Blue	USD 1,007.00	-
MAMBPDLP22-TAUP	Taupe	USD 1,007.00	-
MAMBPDLP22-WHIT	White	USD 1,007.00	-
Extras			
MLPCAPL	Ceiling Cap - White	USD 28.00	-

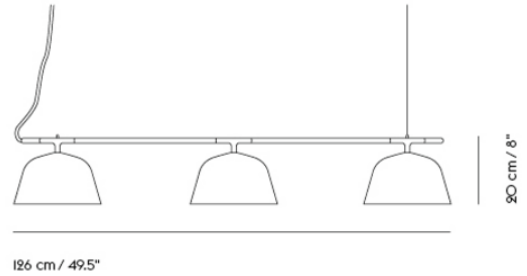

- Shipper Colli 1
- Gross Weight (kg) 4
- Net Weight (kg) 2
- Bulb included No
- Warranty Period 5 years

Pattern No.	Color	Contract Price	Lead Time
Ready-To-Ship US Warehouse			
MAMBRALP-BLCK	Black	USD 1,521.00	-
MAMBRALP-GREY	Grey	USD 1,521.00	-
MAMBRALP-TAUP	Taupe	USD 1,521.00	-
MAMBRALP-WHIT	White	USD 1,521.00	-

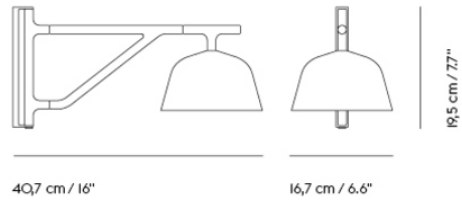

Shipper Colli	1
Gross Weight (kg)	1.734
Net Weight (kg)	1.04
Bulb included	Yes. Not applicable for North America,
Warranty Period	5 years

Pattern No.	Color	Contract Price	Lead Time
Ready-To-Ship US Warehouse			
MAMBWLLP-BLCK	Black	USD 639.00	-
MAMBWLLP-GREY	Grey	USD 639.00	-
MAMBWLLP-TAUP	Taupe	USD 639.00	-
MAMBWLLP-WHIT	White	USD 639.00	-

BEAM TABLE LAMP

FOR MORE INFORMATION,
EXPLORE BELOW

- ↗ [Product Fact Sheet](#)
- ↗ [Images](#)
- ↗ [Architect Files](#)
- ↗ [Assembly Instructions](#)
- ↗ [Product Declaration](#)
- ↗ [Lighting Files](#)



Shipper Colli |
Gross Weight (kg) 1.72
Net Weight (kg) 1.234
Bulb included Yes. Integrated non-replaceable LED
Warranty Period 5 years

Pattern No.	Color	Contract Price	Lead Time
Ready-To-Ship US Warehouse			
MBEATBLP-ALUM	Aluminum	USD 492.00	-
MBEATBLP-BLCK	Black	USD 492.00	-
MBEATBLP-GREN	Green	USD 492.00	-
MBEATBLP-UMBR	Umber	USD 492.00	-

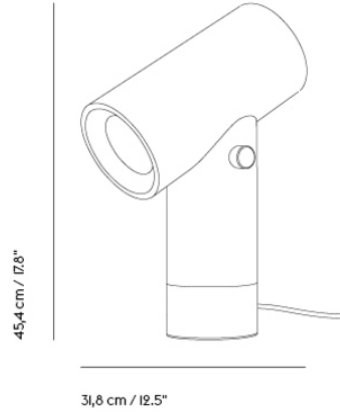

Shipper Colli 1
Gross Weight (kg) 9.08
Net Weight (kg) 6.6
Bulb included Yes. Integrated replaceable LED
Warranty Period 5 years

Pattern No.	Color	Contract Price	Lead Time
Ready-To-Ship US Warehouse			
MBEATBLP18-BLCK	Black	USD 1,416.00	-
MBEATBLP18-ALU	Polished Aluminum	USD 1,416.00	-

CONTROL TABLE LAMP

FOR MORE INFORMATION,
EXPLORE BELOW

- ↗ [Product Fact Sheet](#)
- ↗ [Images](#)
- ↗ [Architect Files](#)
- ↗ [Assembly Instructions](#)
- ↗ [Product Declaration](#)
- ↗ [Lighting Files](#)

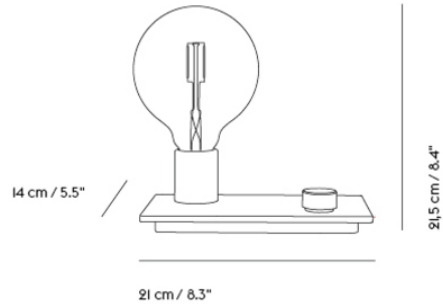

Shipper Colli 1
Gross Weight (kg) 1.4055
Net Weight (kg) 0.9125
Bulb included Yes
Warranty Period 5 years

Pattern No.	Color	Contract Price	Lead Time
Ready-To-Ship US Warehouse			
MCONTBLP-BLCK	Black	USD 299.00	-
MCONTBLP-GREY	Grey	USD 299.00	-
MCONTBLP-RED	Red	USD 299.00	-
MCONTBLP-WHIT	White	USD 299.00	-

DEDICATE LAMP SERIES

FOR MORE INFORMATION,
EXPLORE BELOW

- ↗ [Product Fact Sheet](#)
- ↗ [Images](#)
- ↗ [Architect Files](#)
- ↗ [Assembly Instructions](#)
- ↗ [Product Declaration](#)
- ↗ [Lighting Files](#)

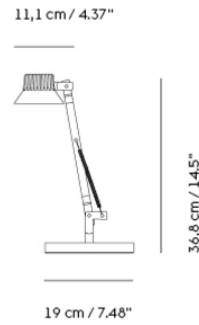

- Shipper Colli 2
- Gross Weight (kg) 5.26
- Net Weight (kg) 4.41
- Bulb included Dimmable, integrated, and non-user replaceable LED
- Warranty period 5 years

Pattern No.	Color	Contract Price	Lead Time
Ready-To-Ship EU Warehouse			
MDDCLS1TBLP-BLCK	Black	USD 786.00	-
MDDCLS1TBLP-BRGR	Brown Green	USD 786.00	-

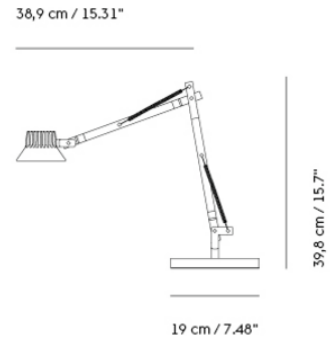

- Shipper Colli 2
- Gross Weight (kg) 5.59
- Net Weight (kg) 4.52
- Bulb included Dimmable, integrated, and non-user replaceable LED
- Warranty period 5 years

Pattern No.	Color	Contract Price	Lead Time
Ready-To-Ship EU Warehouse			
MDDCLS2TBLP/BLCK	Black	USD 835.00	-
MDDCLS2TBLP-BRGR	Brown Green	USD 835.00	-

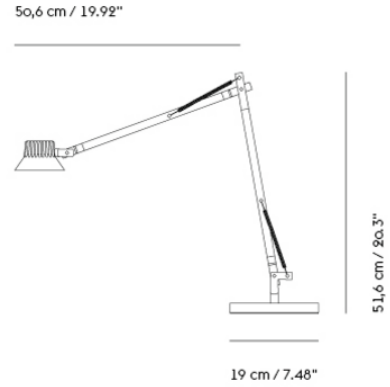

- Shipper Colli 2
- Gross Weight (kg) 5.74
- Net Weight (kg) 4.555
- Bulb included Dimmable, integrated, and non-user replaceable LED
- Warranty period 5 years

Pattern No.	Color	Contract Price	Lead Time
Ready-To-Ship EU Warehouse			
MDDCLL2TBLP-BLCK	Black	USD 835.00	-
MDDCLL2TBLP-BRGR	Brown Green	USD 835.00	-

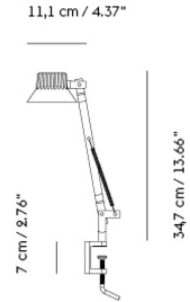

- Shipper Colli 2
- Gross Weight (kg) 0.885
- Net Weight (kg) 0.605
- Bulb included Dimmable, integrated, and non-user replaceable LED
- Warranty period 5 years

Pattern No.	Color	Contract Price	Lead Time
Ready-To-Ship EU Warehouse			
MDDCLS1WC-BLCK	Black	USD 629.00	-
MDDCLS1WC-BRGR	Brown Green	USD 629.00	-

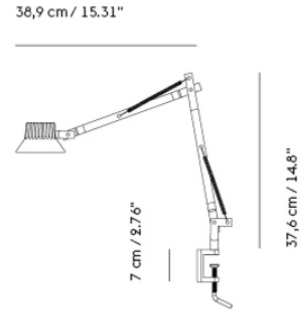
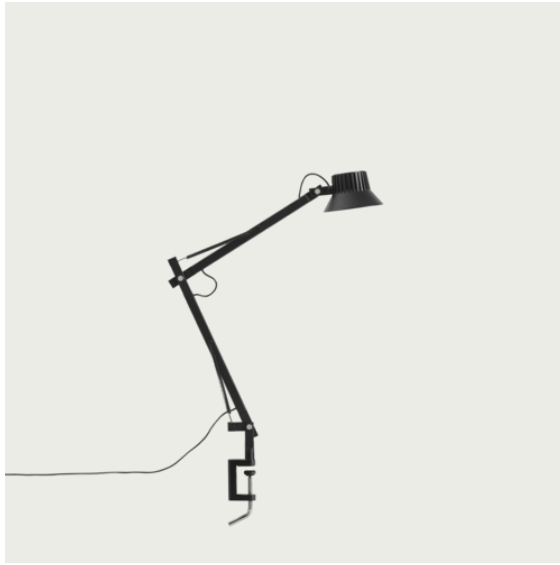

- Shipper Colli 2
- Gross Weight (kg) 1.215
- Net Weight (kg) 0.715
- Bulb included Dimmable, integrated, and non-user replaceable LED
- Warranty period 5 years

Pattern No.	Color	Contract Price	Lead Time
Ready-To-Ship EU Warehouse			
MDDCLS2WC-BLCK	Black	USD 677.00	-
MDDCLS2WC-BRGR	Brown Green	USD 677.00	-

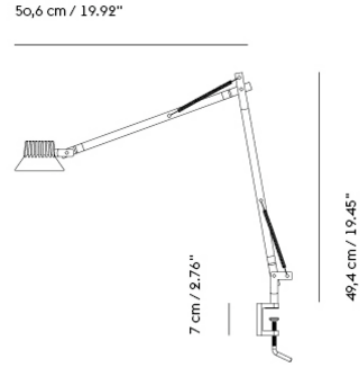

- Shipper Colli 2
- Gross Weight (kg) 1.365
- Net Weight (kg) 0.75
- Bulb included Dimmable, integrated, and non-user replaceable LED
- Warranty period 5 years

Pattern No.	Color	Contract Price	Lead Time
Ready-To-Ship EU Warehouse			
MDDCLL2WC-BLCK	Black	USD 677.00	-
MDDCLL2WC-BRGR	Brown Green	USD 677.00	-

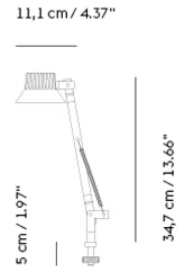

- Shipper Colli 2
- Gross Weight (kg) 0.76407
- Net Weight (kg) 0.58
- Bulb included Dimmable, integrated, and non-user replaceable LED
- Warranty period 5 years

Pattern No.	Color	Contract Price	Lead Time
Ready-To-Ship EU Warehouse			
MDDCLS1WP-BLCK	Black	USD 629.00	-
MDDCLS1WP-BRGR	Brown Green	USD 629.00	-

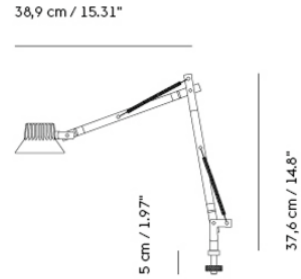

Shipper Colli 2
Gross Weight (kg) 1.235
Net Weight (kg) 0.69
Bulb included Dimmable, integrated, and non-user replaceable LED
Warranty period 5 years

Pattern No.	Color	Contract Price	Lead Time
Ready-To-Ship EU Warehouse			
MDDCLS2WP-BLCK	Black	USD 677.00	-
MDDCLS2WP-BRGR	Brown Green	USD 677.00	-

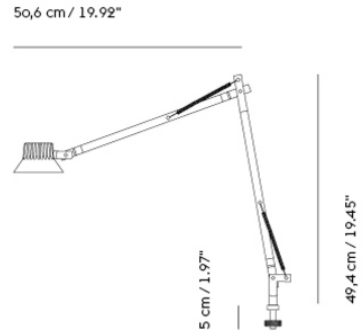

- Shipper Colli 2
- Gross Weight (kg) 1.385
- Net Weight (kg) 0.725
- Bulb included Dimmable, integrated, and non-user replaceable LED
- Warranty period 5 years

Pattern No.	Color	Contract Price	Lead Time
Ready-To-Ship EU Warehouse			
MDDCLL2WP-BLCK	Black	USD 677.00	-
MDDCLL2WP-BRGR	Brown Green	USD 677.00	-

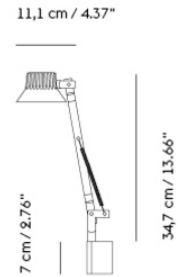
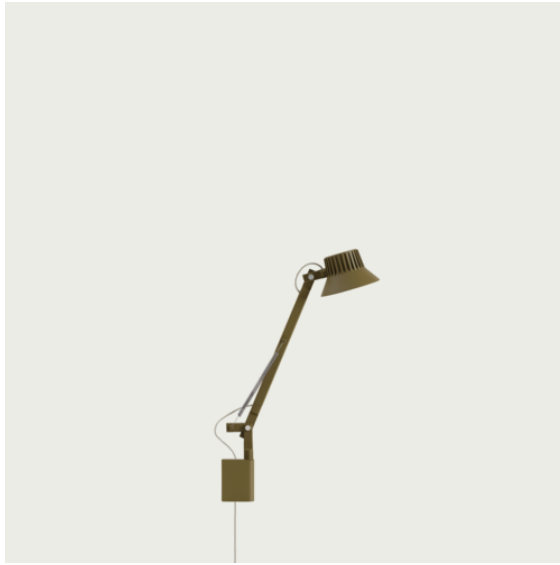

- Shipper Colli 2
- Gross Weight (kg) 0.84
- Net Weight (kg) 0.56
- Bulb included Dimmable, integrated, and non-user replaceable LED
- Warranty period 5 years

Pattern No.	Color	Contract Price	Lead Time
Ready-To-Ship EU Warehouse			
MDDCLS1WLLP-BLCK	Black	USD 629.00	-
MDDCLS1WLLP-BRGR	Brown Green	USD 629.00	-

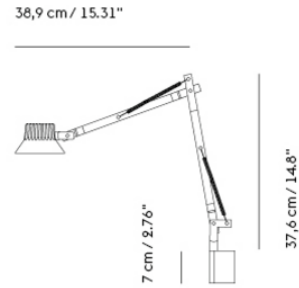
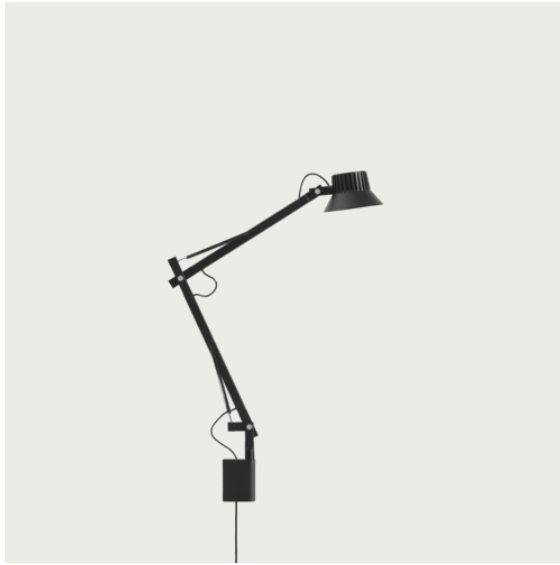

- Shipper Colli 2
- Gross Weight (kg) 1.17
- Net Weight (kg) 0.67
- Bulb included Dimmable, integrated, and non-user replaceable LED
- Warranty period 5 years

Pattern No.	Color	Contract Price	Lead Time
Ready-To-Ship EU Warehouse			
MDDCLS2WLLP-BLCK	Black	USD 677.00	-
MDDCLS2WLLP-BRGR	Brown Green	USD 677.00	-

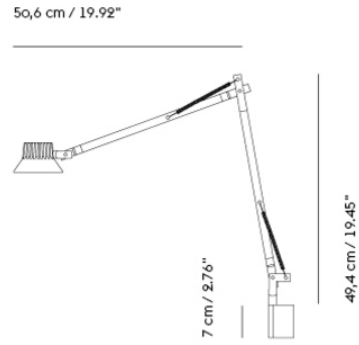

- Shipper Colli 2
- Gross Weight (kg) 1.32
- Net Weight (kg) 0.705
- Bulb included Dimmable, integrated, and non-user replaceable LED
- Warranty period 5 years

Pattern No.	Color	Contract Price	Lead Time
Ready-To-Ship EU Warehouse			
MDDCLL2WLLP-BLCK	Black	USD 677.00	-
MDDCLL2WLLP-BRGR	Brown Green	USD 677.00	-

E27 PENDANT LAMP

FOR MORE INFORMATION,
EXPLORE BELOW

- ↗ [Product Fact Sheet](#)
- ↗ [Images](#)
- ↗ [Architect Files](#)
- ↗ [Assembly Instructions](#)
- ↗ [Product Declaration](#)
- ↗ [Lighting Files](#)

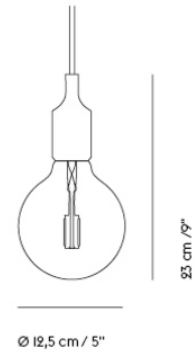

Shipper Colli	1
Gross Weight (kg)	0.7
Net Weight (kg)	0.3
Bulb included	Yes
Warranty Period	5 years

Pattern No.	Color	Contract Price	Lead Time
Ready-To-Ship US Warehouse			
ME27PDLP-DKGY	Dark Grey		-
ME27PDLP-BERO	Beige-Rose	USD 152.00	-
ME27PDLP-BLCK	Black	USD 152.00	-
ME27PDLP-CLBW	Clay Brown	USD 152.00	-
ME27PDLP-DKGN	Dark Green	USD 152.00	-
ME27PDLP-DPRD	Deep Red	USD 152.00	-
ME27PDLP-DLAC	Dusty Lilac	USD 152.00	-
ME27PDLP-LTBU	Light Blue	USD 152.00	-
ME27PDLP-LIGY	Light Grey	USD 152.00	-
ME27PDLP-LTOR	Light Orange	USD 152.00	-
ME27PDLP-MBLU	Midnight Blue	USD 152.00	-
ME27PDLP-MSTD	Mustard	USD 152.00	-
ME27PDLP-OLIV	Olive	USD 152.00	-
ME27PDLP-ORNG	Orange	USD 152.00	-
ME27PDLP-PABU	Pale Blue	USD 152.00	-
ME27PDLP-RED	Red	USD 152.00	-
ME27PDLP-ROSE	Rose	USD 152.00	-
ME27PDLP-TERR	Terracotta ***	USD 152.00	-
ME27PDLP-WHIT	White	USD 152.00	-
ME27PDLP-YELW	Yellow	USD 152.00	-

Pattern No.	Color	Contract Price	Lead Time
Extras			
MLPCRDE27P-BLCK	Unfold / E27 Cord - Black (per linear meter)	USD 4.00	-
MLPCRDE27P-OLIV	Unfold / E27 Cord - Olive (per linear meter)	USD 4.00	-
MLPCRDE27P-BEGN	E27 Cord - Beige-Green (per linear meter)	USD 5.00	-
MLPCRDE27P-BERO	E27 Cord - Beige-Rose (per linear meter)	USD 5.00	-
MLPCRDE27P-BLCK	E27 Cord - Black (per linear meter)	USD 5.00	-
MLPCRDE27P-BLUE	E27 Cord - Blue (per linear meter)	USD 5.00	-
MLPCRDE27P-BURG	E27 Cord - Burgundy (per linear meter)	USD 5.00	-
MLPCRDE27P-CLBW	E27 Cord - Clay Brown (per linear meter)	USD 5.00	-
MLPCRDE27P-LIGN	E27 Cord - Light Green (per linear meter)	USD 5.00	-
MLPCRDE27P-MSTD	E27 Cord - Mustard (per linear meter)	USD 5.00	-
MLPCRDE27P-PABU	E27 Cord - Pale Blue (per linear meter)	USD 5.00	-
MLPCRDE27P-RED	E27 Cord - Red (per linear meter)	USD 5.00	-
MLPCRDE27P-TERR	E27 Cord - Terracotta (per linear meter)	USD 5.00	-
MLPCRDE27P-YELW	E27 Cord - Yellow (per linear meter)	USD 5.00	-
MLPCRDUNFP-ORNG	Unfold / E27 Cord - Orange (per linear meter)	USD 5.00	-
MLPCAPL	Ceiling Cap - White	USD 28.00	-
MBULBLED	Dimmable Bulb for E27 Pendant Lamp	USD 42.00	-
ME27CPY	Multiple Canopy for E27 - White	USD 45.00	-

FLUID PENDANT LAMP

FOR MORE INFORMATION,
EXPLORE BELOW

- ↗ [Product Fact Sheet](#)
- ↗ [Images](#)
- ↗ [Architect Files](#)
- ↗ [Assembly Instructions](#)
- ↗ [Product Declaration](#)
- ↗ [Lighting Files](#)

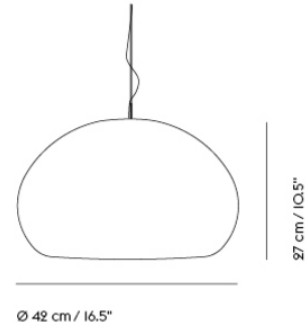

Shipper Colli 1
Gross Weight (kg) 4.95
Net Weight (kg) 3.1
Bulb included No
Warranty Period 5 years

Pattern No.	Color	Contract Price	Lead Time
Ready-To-Ship US Warehouse			
MFLUPDLPLG	Opal White	USD 667.00	-
Extras			
MBULBP	Dimmable Bulb for Fluid Small and Grain Pendant Lamp	USD 37.00	-
MLPCAPW	Ceiling Cap for wire suspension lamps - White	USD 58.00	-

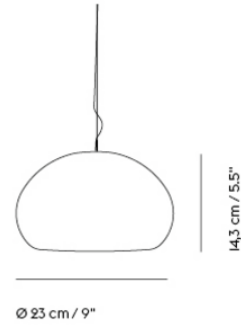
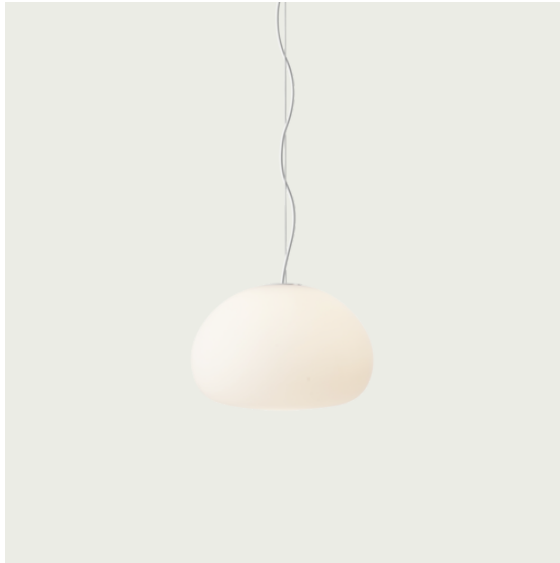

Shipper Colli	1
Gross Weight (kg)	1.55
Net Weight (kg)	0.85
Bulb included	Yes
Warranty Period	5 years

Pattern No.	Color	Contract Price	Lead Time
Ready-To-Ship US Warehouse			
MFLUPDLPSM	Opal White	USD 362.00	-
Extras			
MBULBP	Dimmable Bulb for Fluid Small and Grain Pendant Lamp	USD 37.00	-
MLPCAPW	Ceiling Cap for wire suspension lamps - White	USD 58.00	-

GRAIN PENDANT LAMP

FOR MORE INFORMATION,
EXPLORE BELOW

- ↗ [Product Fact Sheet](#)
- ↗ [Images](#)
- ↗ [Architect Files](#)
- ↗ [Assembly Instructions](#)
- ↗ [Lighting Files](#)
- ↗ [Product Declaration](#)

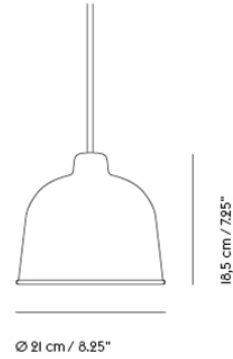

Shipper Colli	1
Gross Weight (kg)	1.17
Net Weight (kg)	0.76
Bulb included	Yes
Warranty Period	5 years

Pattern No.	Color	Contract Price	Lead Time
Ready-To-Ship US Warehouse			
MGRAPDLP-BLCK	Black	USD 303.00	-
MGRAPDLP-BUGY	Blue Grey	USD 303.00	-
MGRAPDLP-DKGN	Dark Green	USD 303.00	-
MGRAPDLP-DGRN	Dusty Green	USD 303.00	-
MGRAPDLP-GREY	Grey	USD 303.00	-
MGRAPDLP-NATU	Nature	USD 303.00	-
MGRAPDLP-WHIT	White	USD 303.00	-
Extras			
MLPCRDGRNP-BUGY	Grain Cord - Blue-Grey (per linear meter)	USD 5.00	-
MLPCRDGRNP-DKGN	Grain Cord - Dark Green (per linear meter)	USD 5.00	-
MLPCRDGRNP-DGRN	Grain Cord - Dusty Green (per linear meter)	USD 5.00	-
MLPCRDGRNP-GREY	Grain Cord - Grey (per linear meter)	USD 5.00	-
MLPCRDGRNP-NATU	Grain Cord - Nature (per linear meter)	USD 5.00	-
MLPCRDGRNP-BLCK	Rime Ø12+Ø25 / Grain Cord - Black (per linear meter)	USD 5.00	-
MLPCRDGRNP-WHIT	Rime Ø12+Ø25 / Grain Cord - White (per linear meter)	USD 5.00	-
MLPCAPL	Ceiling Cap - White	USD 28.00	-
MBULBP	Dimmable Bulb for Fluid Small and Grain Pendant Lamp	USD 37.00	-

LEAF LAMP SERIES

FOR MORE INFORMATION,
EXPLORE BELOW

- ↗ [Product Fact Sheet](#)
- ↗ [Images](#)
- ↗ [Architect Files](#)
- ↗ [Assembly Instructions](#)
- ↗ [Product Declaration](#)
- ↗ [Lighting Files](#)



15,5 x 16,5 cm / 6" x 7.25"



41,5 cm / 16.35"

18 cm / 7"

Shipper Colli	1
Gross Weight (kg)	2.5
Net Weight (kg)	1.75
Bulb included	Yes. Integrated non-replaceable LED
Warranty Period	5 years

Pattern No.	Color	Contract Price	Lead Time
Ready-To-Ship US Warehouse			
MLEATBLP-BLCK	Black	USD 492.00	-
MLEATBLP-CPBN	Copper Brown	USD 492.00	-
MLEATBLP-DKGN	Dark Green	USD 492.00	-
MLEATBLP-GREY	Grey	USD 492.00	-
MLEATBLP-WHIT	White	USD 492.00	-

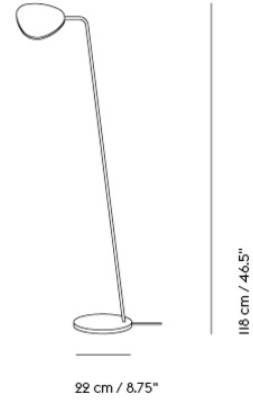
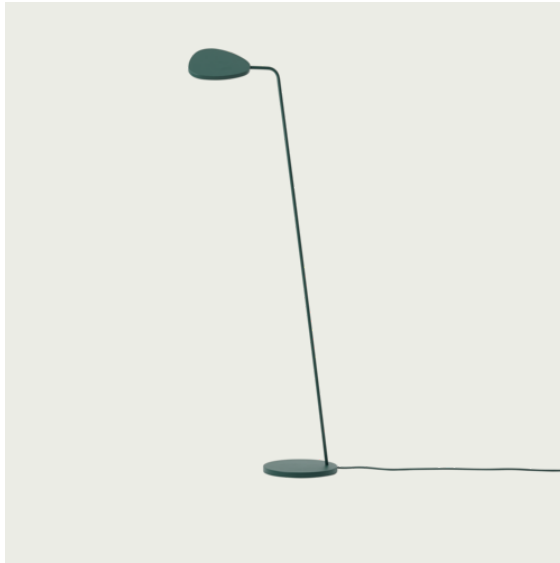

Shipper Colli	1
Gross Weight (kg)	5.2
Net Weight (kg)	2.8
Bulb included	Yes. Integrated non-replaceable LED
Warranty Period	5 years

Pattern No.	Color	Contract Price	Lead Time
Ready-To-Ship US Warehouse			
MLEAFLLP-BLCK	Black	USD 671.00	-
MLEAFLLP-CPBN	Copper Brown	USD 671.00	-
MLEAFLLP-DKGN	Dark Green	USD 671.00	-
MLEAFLLP-GREY	Grey	USD 671.00	-
MLEAFLLP-WHIT	White	USD 671.00	-

LINEAR LAMP SERIES

FOR MORE INFORMATION,
EXPLORE BELOW

- ↗ [Product Fact Sheet](#)
- ↗ [Images](#)
- ↗ [Architect Files](#)
- ↗ [Assembly Instructions](#)
- ↗ [Product Declaration](#)
- ↗ [Lighting Files](#)



- Shipper Colli** | 1
- Gross Weight (kg)** | 1.832
- Net Weight (kg)** | 1.3
- Bulb included** | Yes. Integrated, dimmable, non-replaceable LED module.
- Add-ons** | Please visit planner.muuto.com/linear for recommended lighting, power and accessories
- Warranty Period** | 5 years

Pattern No.	Color	Contract Price	Lead Time
Ready-To-Ship US Warehouse			
MLINLTBLP-BLCK	Black	USD 492.00	-
MLINLTBLP-GREY	Grey	USD 492.00	-

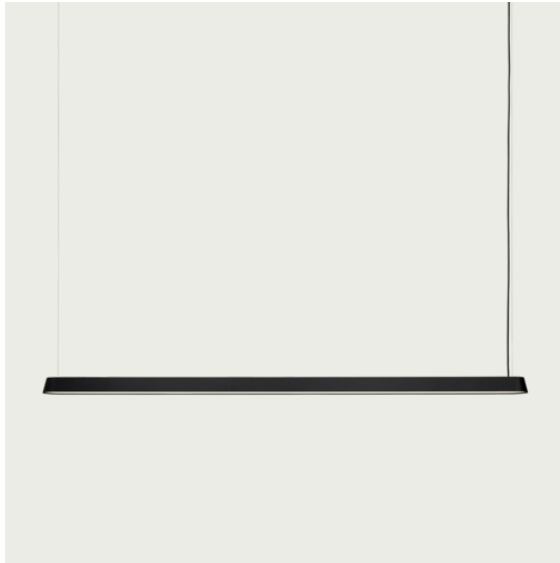

W 169,2 cm / 66.6"
D 10,7 cm / 4.2"

Shipper Colli	1
Gross Weight (kg)	4.9
Net Weight (kg)	3.3
Bulb included	Yes. Integrated non-replaceable LED.
Warranty Period	5 years

Pattern No.	Color	Contract Price	Lead Time
Ready-To-Ship US Warehouse			
MLINLPDLP66-BLCK	Black	USD 1,465.00	-
MLINLPDLP66-GREY	Grey	USD 1,465.00	-

LINEAR PENDANT LAMP / 87,2 CM / 34.3"

529



W 87,2 cm / 34,3"
D 10,7 cm / 4,2"

Shipper Colli	1
Gross Weight (kg)	3.2
Net Weight (kg)	2.2
Bulb included	Yes. Integrated non-replaceable LED.
Warranty Period	5 years

Pattern No.	Color	Contract Price	Lead Time
Ready-To-Ship US Warehouse			
MLINLPDLP34-BLCK	Black	USD 1,101.00	-
MLINLPDLP34-GREY	Grey	USD 1,101.00	-

LINEAR MOUNTED LAMP / 209,2 CM / 82.4"

530

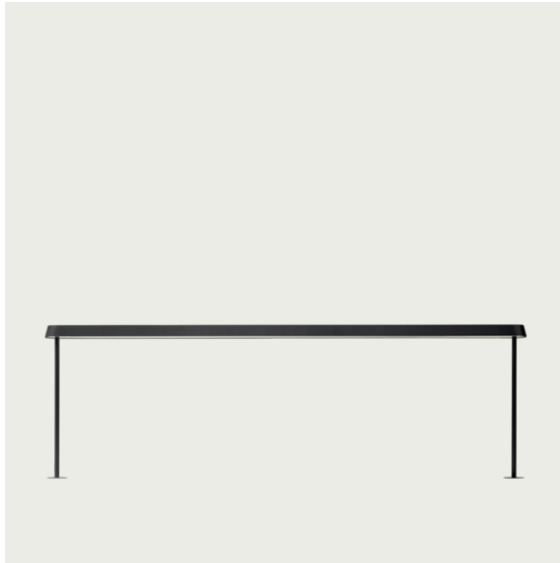

Shipper Colli	1
Gross Weight (kg)	7.8
Net Weight (kg)	4.8
Please note	Only usable with Linear System Power Kit. The connector pins in this product contains lead, CAS no. 7439-92-1.
Bulb included	Yes. Integrated non-replaceable LED.
Warranty Period	5 years

Pattern No.	Color	Contract Price	Lead Time
Ready-To-Ship US Warehouse			
MLINSYML82-BLCK	Black	USD 2,046.00	-
MLINSYML82-GREY	Grey	USD 2,046.00	-

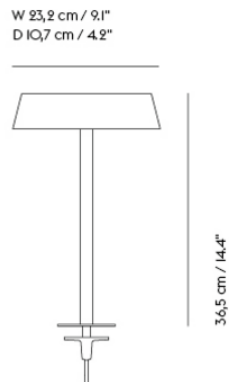

Shipper Colli	1
Gross Weight (kg)	1.5
Net Weight (kg)	1
Please note	1. Only usable with Linear System Power Kit. The connector pins in this product contains lead, CAS no. 7439-92-
Bulb included	Yes. Integrated non-replaceable LED.
Warranty Period	5 years

Pattern No.	Color	Contract Price	Lead Time
Ready-To-Ship US Warehouse			
MLINSYML9-BLCK	Black	USD 614.00	-
MLINSYML9-GREY	Grey	USD 614.00	-

POST LAMP SERIES

FOR MORE INFORMATION,
EXPLORE BELOW

- ↗ [Product Fact Sheet](#)
- ↗ [Images](#)
- ↗ [Architect Files](#)
- ↗ [Assembly Instructions](#)
- ↗ [Product Declaration](#)
- ↗ [Lighting Files](#)

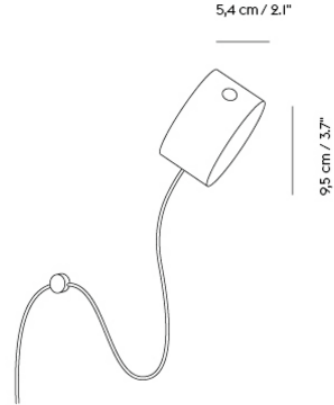

Shipper Colli |
Gross Weight (kg) 1.05
Net Weight (kg) 0.55
Bulb included Yes. Integrated non-replaceable LED
Warranty Period 5 years

Pattern No.	Color	Contract Price	Lead Time
Ready-To-Ship US Warehouse			
MPOSWLLP	Black	USD 492.00	-
Extras			
MPOSWMNT	Extra Wall Mount - Black	USD 41.00	-

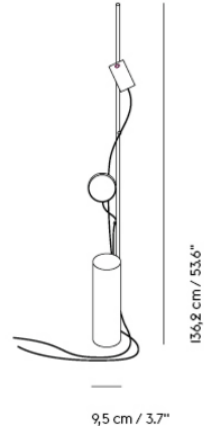
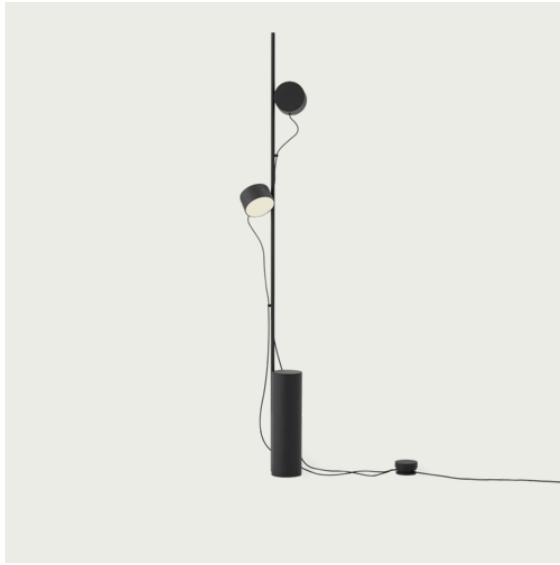

- Shipper Colli 1
- Gross Weight (kg) 12.5
- Net Weight (kg) 10.2
- Bulb included Yes. Integrated non-replaceable LED
- Warranty Period 5 years

Pattern No.	Color	Contract Price	Lead Time
Ready-To-Ship US Warehouse			
MPOSFLP	Black	USD 1,206.00	-
Extras			
MPLCD	Extra Cable Drops - Black	USD 49.00	-

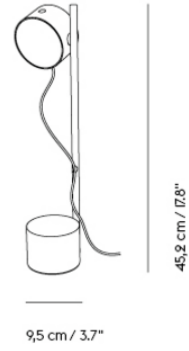

Shipper Colli 1
Gross Weight (kg) 3.9
Net Weight (kg) 2.9
Bulb included Yes. Integrated non-replaceable LED
Warranty Period 5 years

Pattern No.	Color	Contract Price	Lead Time
Ready-To-Ship US Warehouse			
MPOSTBLP-BLCK	Black	USD 828.00	-
MPOSTBLP-BRGR	Brown Green	USD 828.00	-

PULL FLOOR LAMP

FOR MORE INFORMATION,
EXPLORE BELOW

- ↗ [Product Fact Sheet](#)
- ↗ [Images](#)
- ↗ [Architect Files](#)
- ↗ [Assembly Instructions](#)
- ↗ [Product Declaration](#)

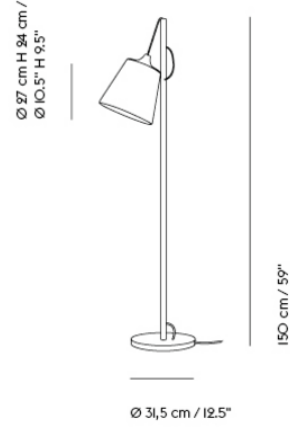

Shipper Colli 1
Gross Weight (kg) 6.75
Net Weight (kg) 3.75
Bulb included No
Warranty Period 5 years

Pattern No.	Color	Contract Price	Lead Time
Ready-To-Ship US Warehouse			
MPULFLLP-GREYW	Grey/White	USD 786.00	-
MPULFLLP-OAKW	Oak/White	USD 786.00	-

RIME LAMP SERIES

FOR MORE INFORMATION,
EXPLORE BELOW

- ↗ [Product Fact Sheet](#)
- ↗ [Images](#)
- ↗ [Architect Files](#)
- ↗ [Assembly Instructions](#)
- ↗ [Product Declaration](#)
- ↗ [Lighting Files](#)

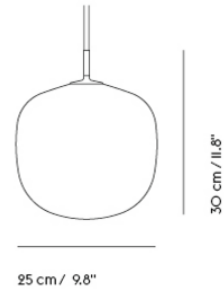

Shipper Colli	1
Gross Weight (kg)	3.4
Net Weight (kg)	1.5
Bulb included	No
Warranty Period	5 years

Pattern No.	Color	Contract Price	Lead Time
Ready-To-Ship US Warehouse			
MRIMPDLP09-BLCK	Black	USD 509.00	-
MRIMPDLP09-WHIT	White	USD 509.00	-
Extras			
MLPCRDGRNP-BLCK	Rime Ø12+Ø25 / Grain Cord - Black (per linear meter)	USD 5.00	-
MLPCRDGRNP-WHIT	Rime Ø12+Ø25 / Grain Cord - White (per linear meter)	USD 5.00	-
MLPCAPL	Ceiling Cap - White	USD 28.00	-

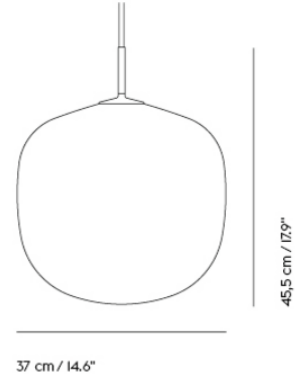

Shipper Colli	1
Gross Weight (kg)	5.25
Net Weight (kg)	3.3
Bulb included	No
Warranty Period	5 years

Pattern No.	Color	Contract Price	Lead Time
Ready-To-Ship US Warehouse			
MRIMPDLP14-BLCK	Black	USD 667.00	-
MRIMPDLP14-WHIT	White	USD 667.00	-
Extras			
MLPCRDRIMP-BLCK	Rime Cord Ø37 + Ø45 cm - Black (per linear meter)	USD 10.00	-
MLPCRDRIMP-WHIT	Rime Cord Ø37 + Ø45 cm - White (per linear meter)	USD 10.00	-
MLPCAPL	Ceiling Cap - White	USD 28.00	-

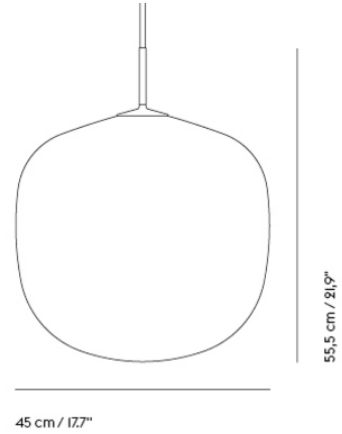

Shipper Colli	1
Gross Weight (kg)	8.5
Net Weight (kg)	4
Bulb included	No
Warranty Period	5 years

Pattern No.	Color	Contract Price	Lead Time
Ready-To-Ship US Warehouse			
MRIMPDLP17-BLCK	Black	USD 902.00	-
MRIMPDLP17-WHIT	White	USD 902.00	-
Extras			
MLPCRDRIMP-BLCK	Rime Cord Ø37 + Ø45 cm - Black (per linear meter)	USD 10.00	-
MLPCRDRIMP-WHIT	Rime Cord Ø37 + Ø45 cm - White (per linear meter)	USD 10.00	-
MLPCAPL	Ceiling Cap - White	USD 28.00	-

SET TABLE LAMP

FOR MORE INFORMATION,
EXPLORE BELOW

- ↗ [Product Fact Sheet](#)
- ↗ [Images](#)
- ↗ [Architect Files](#)
- ↗ [Assembly Instructions](#)
- ↗ [Product Declaration](#)
- ↗ [Lighting Files](#)

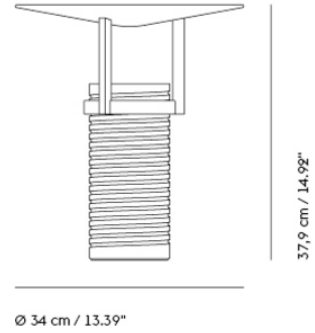

- Shipper Colli | 1
- Gross Weight (kg) | 9.34
- Net Weight (kg) | 6.11
- Bulb included | Dimmable, integrated, and non-user replaceable LED
- Warranty Period | 5 years

Pattern No.	Color	Contract Price	Lead Time
Ready-To-Ship US Warehouse			
MSETTBLP	Aluminum	USD 1,150.00	-

STRAND LAMP SERIES

FOR MORE INFORMATION,
EXPLORE BELOW

- ↗ [Product Fact Sheet](#)
- ↗ [Images](#)
- ↗ [Architect Files](#)
- ↗ [Assembly Instructions](#)
- ↗ [Product Declaration](#)
- ↗ [Lighting Files](#)

STRAND PENDANT LAMP / OPEN - Ø 28 CM / 11"

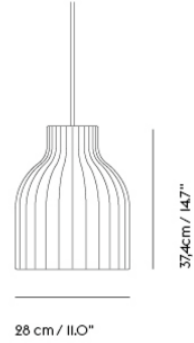

Shipper Colli 1
Gross Weight (kg) 2.35
Net Weight (kg) 1.4
Bulb included No
Warranty Period 5 years

Pattern No.	Color	Contract Price	Lead Time
Ready-To-Ship US Warehouse			
MSTRPDLPO11	White - Open	USD 534.00	-

STRAND PENDANT LAMP / OPEN - Ø 40 CM / 16"

546

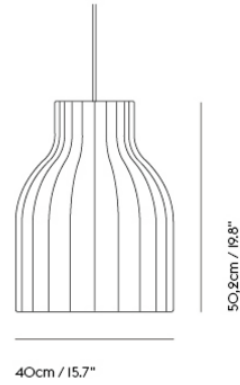

Shipper Colli 1
Gross Weight (kg) 3.7
Net Weight (kg) 2.1
Bulb included No
Warranty Period 5 years

Pattern No.	Color	Contract Price	Lead Time
Ready-To-Ship US Warehouse			
MSTRPDLPO16	White - Open	USD 719.00	-

**STRAND PENDANT LAMP / OPEN - Ø 60
CM / 23.5"**

547

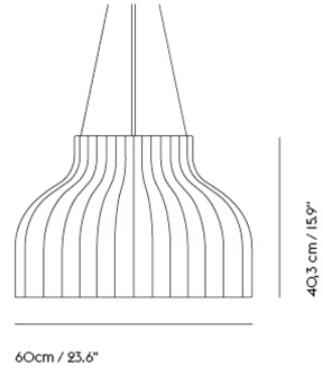

Shipper Colli 1
Gross Weight (kg) 6.6
Net Weight (kg) 4.05
Bulb included No
Warranty Period 5 years

Pattern No.	Color	Contract Price	Lead Time
Ready-To-Ship US Warehouse			
MSTRPDLPO23	White - Open	USD 992.00	-

**STRAND PENDANT LAMP / CLOSED - Ø
45 CM / 17.7"**

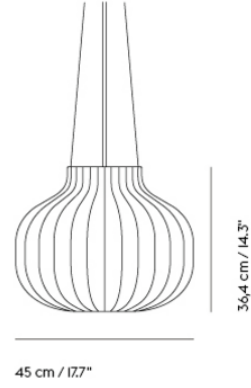
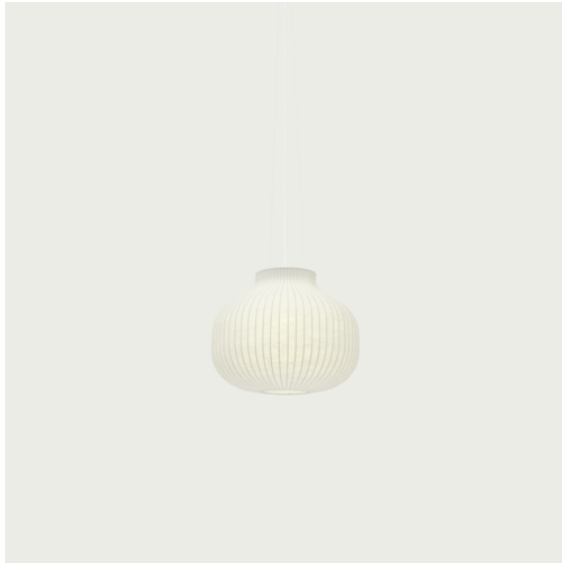

Gross Weight (kg) 4.45
 Net Weight (kg) 2.75
 Bulb included No
 Warranty Period 5 years

Pattern No.	Color	Contract Price	Lead Time
Ready-To-Ship US Warehouse			
MSTRPDLPC17	White - Closed - Ø 17.7"	USD 1,013.00	-

**STRAND PENDANT LAMP / CLOSED - Ø
60 CM / 23.5"**

549

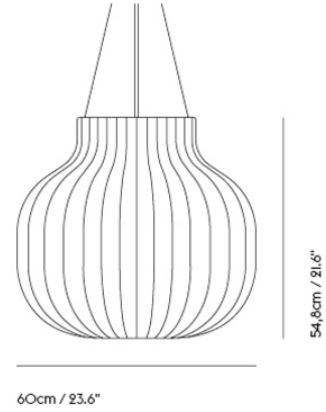

Shipper Colli	1
Gross Weight (kg)	8.4
Net Weight (kg)	5.4
Bulb included	No
Warranty Period	5 years

Pattern No.	Color	Contract Price	Lead Time
Ready-To-Ship US Warehouse			
MSTRPDLPC23	White - Closed	USD 1,101.00	-

**STRAND PENDANT LAMP / CLOSED - Ø
80 CM / 31.5"**

550

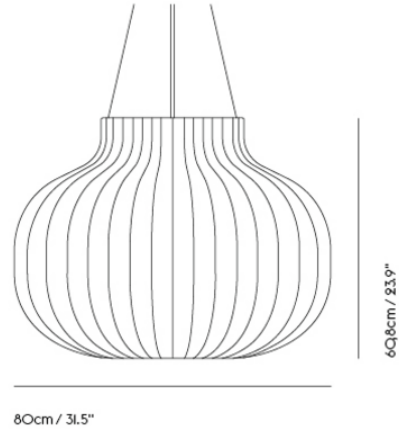

Shipper Colli 1
Gross Weight (kg) 11.05
Net Weight (kg) 6.35
Bulb included No
Warranty Period 5 years

Pattern No.	Color	Contract Price	Lead Time
Ready-To-Ship US Warehouse			
MSTRPDLPC31	White - Closed	USD 1,360.00	-

STRAND TABLE LAMP / H: 39,1 CM / 15.4"



D 29 cm / 11.6"

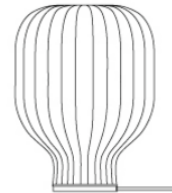

39 cm / 15.4"

Shipper Colli 1
Gross Weight (kg) 5
Net Weight (kg) 2.9
Bulb included No
Warranty Period 5 years

Pattern No.	Color	Contract Price	Lead Time
Ready-To-Ship US Warehouse			
MSTRTBLP15	White	USD 797.00	-

TIP LAMP SERIES

FOR MORE INFORMATION,
EXPLORE BELOW

- ↗ [Product Fact Sheet](#)
- ↗ [Images](#)
- ↗ [Architect Files](#)
- ↗ [Assembly Instructions](#)
- ↗ [Product Declaration](#)
- ↗ [Lighting Files](#)



Shipper Colli	1
Gross Weight (kg)	2.4
Net Weight (kg)	1.5
Bulb included	Yes. Integrated non-replaceable LED
Warranty Period	5 years

Pattern No.	Color	Contract Price	Lead Time
Ready-To-Ship US Warehouse			
MTIPTBLP-BLCK	Black	USD 492.00	-
MTIPTBLP-CPBN	Copper Brown	USD 492.00	-
MTIPTBLP-OLIV	Olive	USD 492.00	-
MTIPTBLP-WHIT	White	USD 492.00	-

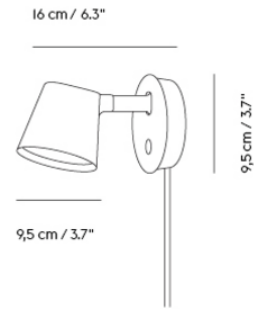

Shipper Colli | 1
Gross Weight (kg) 0.75
Net Weight (kg) 0.45
Bulb included Yes. Integrated non-replaceable LED
Warranty Period 5 years

Pattern No.	Color	Contract Price	Lead Time
Ready-To-Ship US Warehouse			
MTIPWLLP-BLCK	Black	USD 331.00	-
MTIPWLLP-GREY	Grey	USD 331.00	-
MTIPWLLP-WHIT	White	USD 331.00	-

TWO-LAYER PENDANT LAMP

FOR MORE INFORMATION,
EXPLORE BELOW

- ↗ [Product Fact Sheet](#)
- ↗ [Images](#)
- ↗ [Architect Files](#)
- ↗ [Assembly Instructions](#)
- ↗ [Product Declaration](#)
- ↗ [Lighting Files](#)

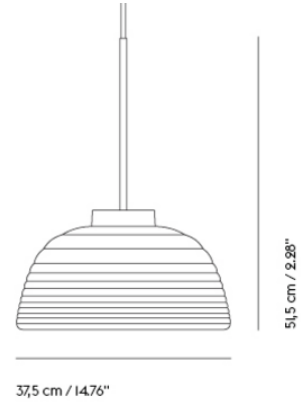

Shipper Colli 1
Gross Weight (kg) 7.5
Net Weight (kg) 4.3
Bulb included Yes.
Warranty Period 5 years

Pattern No.	Color	Contract Price	Lead Time
Ready-To-Ship US Warehouse			
MTLAYPNDLP-BLCK	Black	USD 828.00	-
MTLAYPNDLP-GREY	Grey	USD 828.00	-
Extras			
MTLAYPNDLP-BLCK	Two-Layer Pendant Lamp Cord - Black (per linear meter)	USD 10.00	-
MTLAYPNDLP-GREY	Two-Layer Pendant Lamp Cord - Grey (per linear meter)	USD 10.00	-

UNDER THE BELL PENDANT LAMP

FOR MORE INFORMATION,
EXPLORE BELOW

- ↗ [Product Fact Sheet](#)
- ↗ [Images](#)
- ↗ [Architect Files](#)
- ↗ [Assembly Instructions](#)
- ↗ [Lighting Files](#)
- ↗ [Product Declaration](#)

UNDER THE BELL PENDANT LAMP / Ø 55 CM / 21.7"

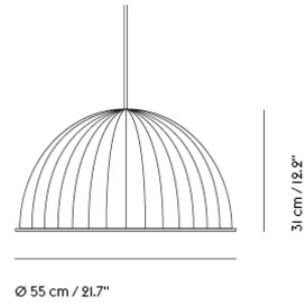

- Shipper Colli 1
- Gross Weight (kg) 2.35
- Net Weight (kg) 1.15
- Bulb included No
- Warranty Period 5 years

Pattern No.	Color	Contract Price	Lead Time
-------------	-------	----------------	-----------

Ready-To-Ship US Warehouse

MUTBPDLPSM-BLCK	Black	USD 761.00	-
MUTBPDLPSM-DKGN	Dark Green	USD 761.00	-
MUTBPDLPSM-GREY	Grey	USD 761.00	-
MUTBPDLPSM-WHME	White Mélange	USD 761.00	-

Extras

MLPCRDUTBP-BLCK	Under the Bell Cord - Black (per linear meter)	USD 4.00	-
MLPCRDUTBP-DKGN	Under the Bell Cord - Dark Green (per linear meter)	USD 4.00	-
MLPCRDUTBP-GREY	Under the Bell Cord - Grey (per linear meter)	USD 4.00	-
MLPCRDUTBP-WHME	Under the Bell Cord - White Mélange (per linear meter)	USD 4.00	-
MLPCAPL	Ceiling Cap - White	USD 28.00	-

UNDER THE BELL PENDANT LAMP / Ø 82 CM / 32.25"

559

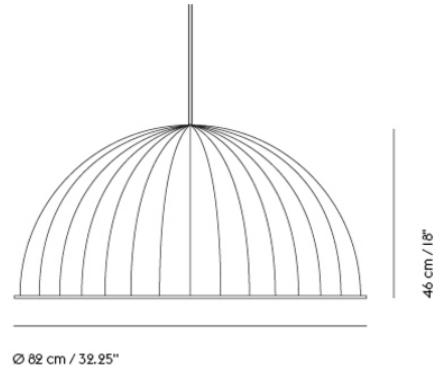

Shipper Colli	1
Gross Weight (kg)	4.95
Net Weight (kg)	2.35
Bulb included	No
Warranty Period	5 years

Pattern No.	Color	Contract Price	Lead Time
Ready-To-Ship US Warehouse			
MUTBPDPLG-BLCK	Black	USD 933.00	-
MUTBPDPLG-DKGN	Dark Green	USD 933.00	-
MUTBPDPLG-GREY	Grey	USD 933.00	-
MUTBPDPLG-WHME	White Mélange	USD 933.00	-
Extras			
MLPCRDUTBP-BLCK	Under the Bell Cord - Black (per linear meter)	USD 4.00	-
MLPCRDUTBP-DKGN	Under the Bell Cord - Dark Green (per linear meter)	USD 4.00	-
MLPCRDUTBP-GREY	Under the Bell Cord - Grey (per linear meter)	USD 4.00	-
MLPCRDUTBP-WHME	Under the Bell Cord - White Mélange (per linear meter)	USD 4.00	-
MLPCAPL	Ceiling Cap - White	USD 28.00	-

UNFOLD PENDANT LAMP

FOR MORE INFORMATION,
EXPLORE BELOW

- ↗ [Product Fact Sheet](#)
- ↗ [Images](#)
- ↗ [Architect Files](#)
- ↗ [Assembly Instructions](#)
- ↗ [Product Declaration](#)
- ↗ [Lighting Files](#)

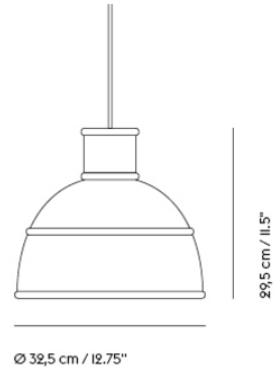

Shipper Colli	1
Gross Weight (kg)	1.8
Net Weight (kg)	1.26
Bulb included	No
Warranty Period	5 years

Pattern No.	Color	Contract Price	Lead Time
Ready-To-Ship US Warehouse			
MUNFPDLP-BEGN	Beige-Green	USD 362.00	-
MUNFPDLP-BERO	Beige-Rose	USD 362.00	-
MUNFPDLP-BLCK	Black	USD 362.00	-
MUNFPDLP-DKGY	Dark Grey	USD 362.00	-
MUNFPDLP-GREN	Green	USD 362.00	-
MUNFPDLP-LIGY	Light Grey	USD 362.00	-
MUNFPDLP-MSTD	Mustard	USD 362.00	-
MUNFPDLP-OLIV	Olive	USD 362.00	-
MUNFPDLP-TERR	Terracotta	USD 362.00	-
MUNFPDLP-YELW	Yellow	USD 362.00	-

Extras			
MLPCRDUNFP-BERO	Unfold / E27 Cord - Beige-Rose (per linear meter)	USD 4.00	-
MLPCRDE27P-BLCK	Unfold / E27 Cord - Black (per linear meter)	USD 4.00	-
MLPCRDE27P-OLIV	Unfold / E27 Cord - Olive (per linear meter)	USD 4.00	-
MLPCRDE27P-TERR	Unfold Cord - Terracotta (per linear meter)	USD 4.00	-
MLPCRDUNFP-ORNG	Unfold / E27 Cord - Orange (per linear meter)	USD 5.00	-
MLPCRDUNFP-BEGN	Unfold Cord - Beige-Green (per linear meter)	USD 5.00	-
MLPCRDUNFP-BURG	Unfold Cord - Burgundy (per linear meter)	USD 5.00	-
MLPCRDUNFP-CLBW	Unfold Cord - Clay Brown (per linear meter)	USD 5.00	-
MLPCRDUNFP-DKGY	Unfold Cord - Dark Grey (per linear meter)	USD 5.00	-

Pattern No.	Color	Contract Price	Lead Time
MLPCRDUNFP-DRED	Unfold Cord - Dusty Red (per linear meter)	USD 5.00	-
MLPCRDUNFP-GREN	Unfold Cord - Green (per linear meter)	USD 5.00	-
MLPCRDUNFP-YELW	Unfold Cord - Yellow (per linear meter)	USD 5.00	-
MLPCAPL	Ceiling Cap - White	USD 28.00	-

ACCESSORIES

AMPLE THROW

FOR MORE INFORMATION,
EXPLORE BELOW

[↗ Product Fact Sheet](#)

[↗ Images](#)

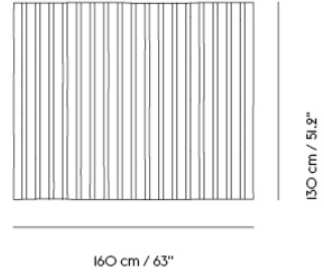

Shipper Colli 1
 Gross Weight (kg) 1.6
 Net Weight (kg) 1.5
 Warranty Period 5 years

Pattern No.	Color	Contract Price	Lead Time
Ready-To-Ship US Warehouse			
MAMPTH-MBLU	Midnight Blue	USD 541.00	-

ARCED MIRROR

FOR MORE INFORMATION,
EXPLORE BELOW

- ↗ [Product Fact Sheet](#)
- ↗ [Images](#)
- ↗ [Architect Files](#)
- ↗ [Assembly Instructions](#)
- ↗ [Product Declaration](#)

ARCED MIRROR / 80 X 55 CM / 31.5 X 21.65"

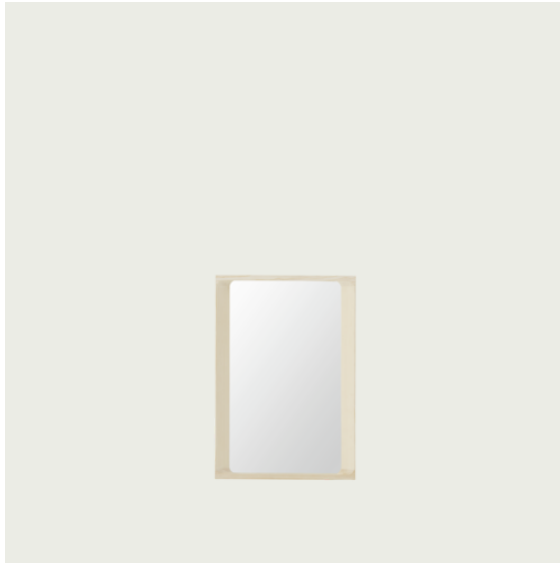

Shipper Colli I
 Gross Weight (kg) 11
 Net Weight (kg) 8.5
 Warranty period 5 years

Pattern No.	Color	Contract Price	Lead Time
Ready-To-Ship US Warehouse			
MARCMIR3222-LGRN	Light Green	USD 719.00	-
MARCMIR3222-LGREY	Light Grey	USD 719.00	-
MARCMIR3222-LLIL	Light Lilac	USD 719.00	-
MARCMIR3222-MTBU	Midnight Blue	USD 719.00	-
MARCMIR3222-SPRU	Spruce	USD 719.00	-

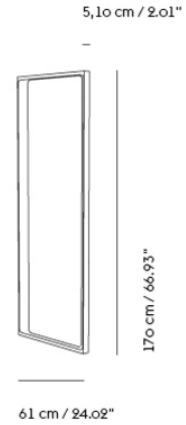
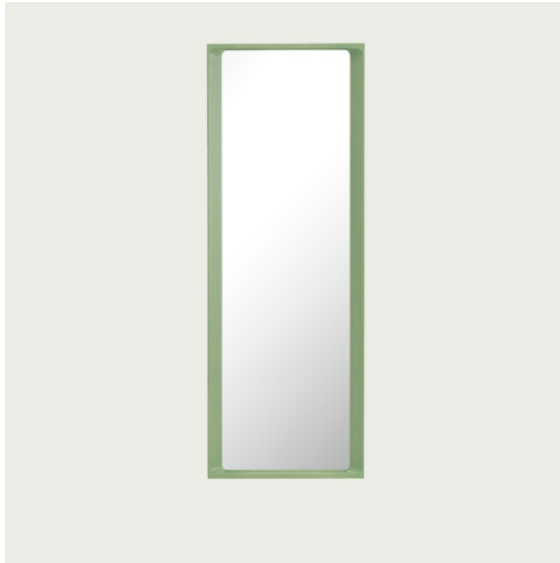

Shipper Colli 1
Gross Weight (kg) 24
Net Weight (kg) 19.5
Warranty period 5 years

Pattern No.	Color	Contract Price	Lead Time
Ready-To-Ship US Warehouse			
MARCMIR6724-LGRN	Light Green	USD 1,255.00	-
MARCMIR6724-LGREY	Light Grey	USD 1,255.00	-
MARCMIR6724-LLIL	Light Lilac	USD 1,255.00	-
MARCMIR6724-MTBU	Midnight Blue	USD 1,255.00	-
MARCMIR6724-SPRU	Spruce	USD 1,255.00	-

ARRANGE DESKTOP SERIES

FOR MORE INFORMATION,
EXPLORE BELOW

- ↗ [Product Fact Sheet](#)
- ↗ [Images](#)
- ↗ [Architect Files](#)
- ↗ [Assembly Instructions](#)
- ↗ [Product Declaration](#)

ARRANGE DESKTOP SERIES / CONFIGURATION I

570

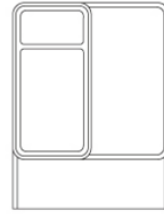
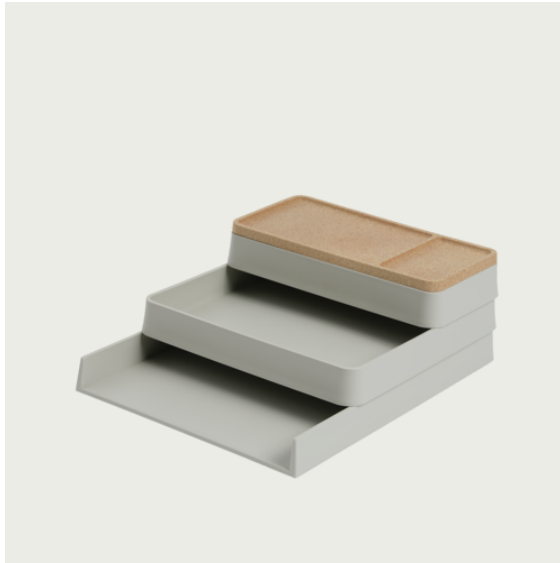

25 cm / 9.8"



32 cm / 12.6"

11 cm / 4.3"

Shipper Colli	1
Gross Weight (kg)	1.696
Net Weight (kg)	0.934
Warranty Period	5 years

Pattern No.	Color	Contract Price	Lead Time
Ready-To-Ship US Warehouse			
MARRDSC1	Grey	USD 131.00	-

ARRANGE DESKTOP SERIES / CONFIGURATION 2

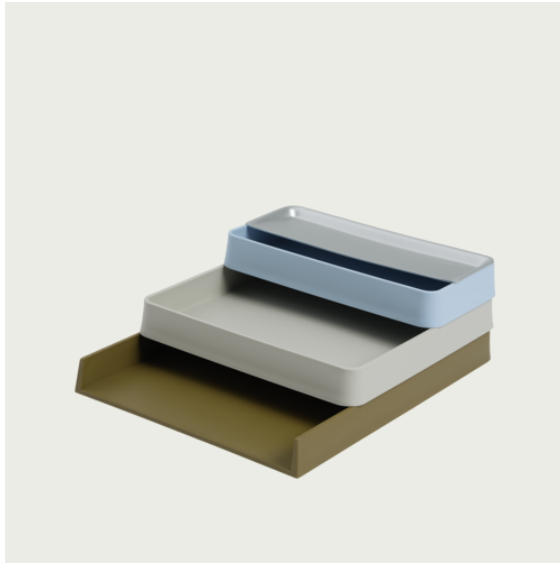

25 cm / 9.8"



32 cm / 12.6"

10 cm / 3.9"

Shipper Colli 1
 Gross Weight (kg) 1.728
 Net Weight (kg) 0.968
 Warranty Period 5 years

Pattern No.	Color	Contract Price	Lead Time
Ready-To-Ship US Warehouse			
MARRDSC2	Multi Colored	USD 131.00	-

ARRANGE DESKTOP SERIES / TRAY - 12 X 25 CM / 4.8 X 9.6"

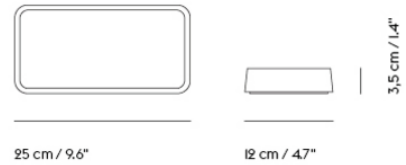

Shipper Colli 1
Gross Weight (kg) 0.259
Net Weight (kg) 0.196
Warranty Period 5 years

Pattern No.	Color	Contract Price	Lead Time
Ready-To-Ship US Warehouse			
MARRDSTR510-GREY	Grey	USD 29.00	-
MARRDSTR510-LTBU	Light Blue	USD 29.00	-

**ARRANGE DESKTOP SERIES / TRAY - 25 X
25 CM / 9.6 X 9.6"**

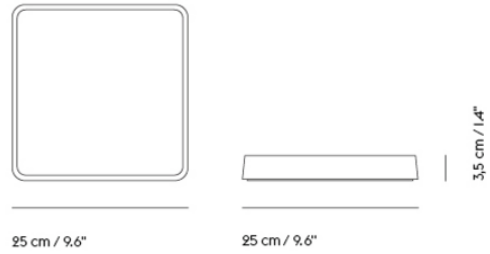

Shipper Colli | 1
Gross Weight (kg) | 0.44
Net Weight (kg) | 0.3325
Warranty Period | 5 years

Pattern No.	Color	Contract Price	Lead Time
Ready-To-Ship US Warehouse			
MARRDSTR1010-GREY	Grey	USD 36.00	-

ARRANGE DESKTOP SERIES / TRAY - 32 X 25 CM / 12.6 X 9.6"

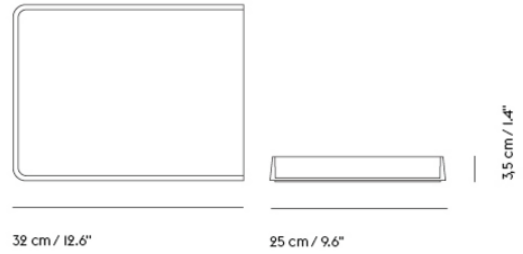
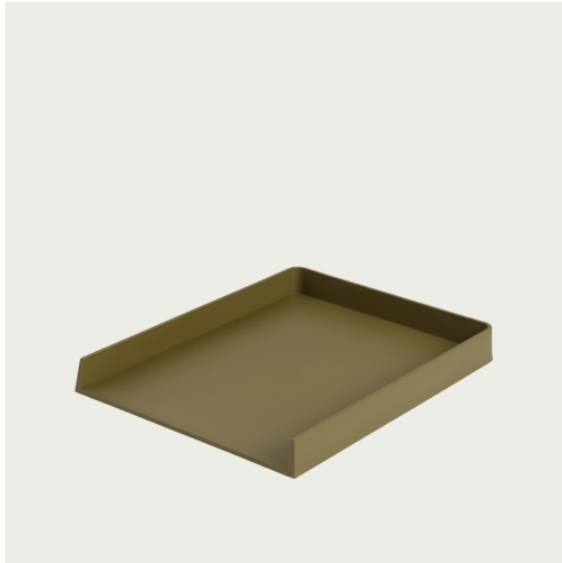

Shipper Colli 1
Gross Weight (kg) 0.599
Net Weight (kg) 0.471
Warranty Period 5 years

Pattern No.	Color	Contract Price	Lead Time
Ready-To-Ship US Warehouse			
MARRDSTR1010-BRGR	Brown Green	USD 46.00	-
MARRDSTR1310-GREY	Grey	USD 46.00	-

ATTACH COAT HOOK

FOR MORE INFORMATION,
EXPLORE BELOW

- ↗ [Product Fact Sheet](#)
- ↗ [Images](#)
- ↗ [Architect Files](#)

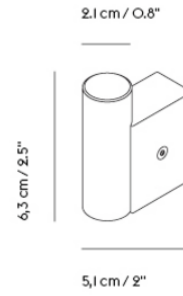

Shipper Colli 1
Gross Weight (kg) 0.24
Net Weight (kg) 0.2
Warranty Period 5 years

Pattern No.	Color	Contract Price	Lead Time
Ready-To-Ship US Warehouse			
MATTCH-ALUM	Oak/Aluminum	USD 89.00	-
MATTCH-BLCK	Oak/Black	USD 89.00	-
MATTCH-BORG	Oak/Burnt Orange	USD 89.00	-
MATTCH-DKGN	Oak/Dark Green	USD 89.00	-
MATTCH-PABU	Oak/Pale Blue	USD 89.00	-

AVAIL COAT RACK

FOR MORE INFORMATION,
EXPLORE BELOW

- ↗ [Product Fact Sheet](#)
- ↗ [Images](#)
- ↗ [Architect Files](#)
- ↗ [Assembly Instructions](#)
- ↗ [Product Declaration](#)

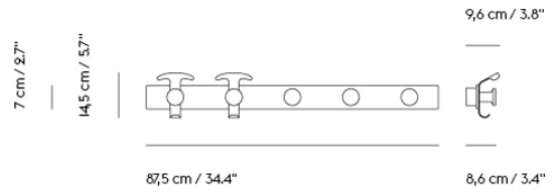
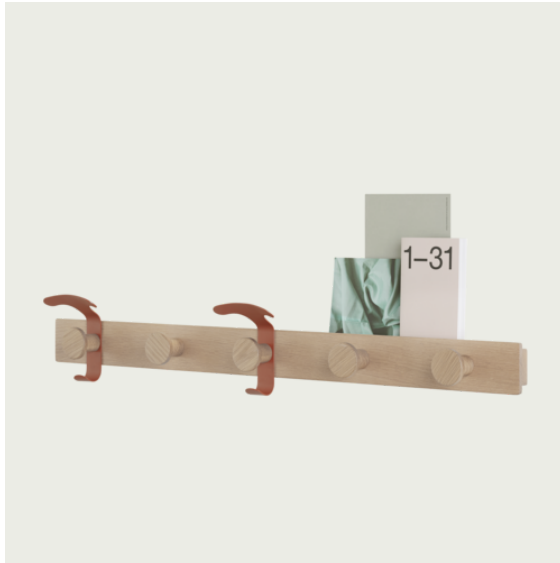

Shipper Colli 1
Gross Weight (kg) 3.14
Net Weight (kg) 2.26
Warranty Period 5 years

Pattern No.	Color	Contract Price	Lead Time
Ready-To-Ship US Warehouse			
MPLCTRK-GREY-GREY	Grey/Grey	USD 278.00	-
MPLCTRK-OAK-BLCK	Oak/Black	USD 278.00	-
MPLCTRK-OAK-GREY	Oak/Grey	USD 278.00	-
MPLCTRK-OAK-CPBN	Oak/Copper Brown	USD 278.00	-
Extras			
MPLCTRKEH-BLCK	Extra Coat Hook - Black	USD 44.00	-
MPLCTRKEH-CPBN	Extra Coat Hook - Copper Brown	USD 44.00	-
MPLCTRKEH-GREY	Extra Coat Hook - Grey	USD 44.00	-

COIL COAT RACK

FOR MORE INFORMATION,
EXPLORE BELOW

- ↗ [Product Fact Sheet](#)
- ↗ [Images](#)
- ↗ [Architect Files](#)
- ↗ [Assembly Instructions](#)

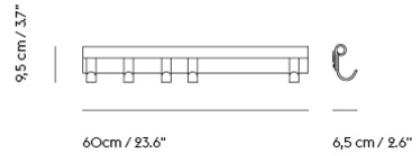

Shipper Colli 1
 Gross Weight (kg) 2
 Net Weight (kg) 1.4
 Warranty Period 5 Years

Pattern No.	Color	Contract Price	Lead Time
Ready-To-Ship US Warehouse			
MCCTR24-BLCK	Black	USD 251.00	-
MCCTR24-PLUM	Plum	USD 251.00	-
Extras			
MCCTRH-BLCK	Extra Coat Hook - Black	USD 36.00	-
MCCTRH-DKGN	Extra Coat Hook - Dark Green	USD 36.00	-
MCCTRH-PLUM	Extra Coat Hook - Plum	USD 36.00	-

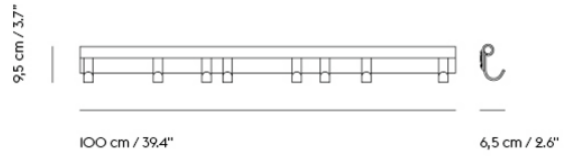

Shipper Colli 1
Gross Weight (kg) 3.3
Net Weight (kg) 2.4
Warranty Period 5 Years

Pattern No.	Color	Contract Price	Lead Time
Ready-To-Ship US Warehouse			
MCCTR39-BLCK	Black	USD 482.00	-
MCCTR39-DKGN	Dark Green	USD 482.00	-
MCCTR39-PLUM	Plum	USD 482.00	-
Extras			
MCCTRH-BLCK	Extra Coat Hook - Black	USD 36.00	-
MCCTRH-DKGN	Extra Coat Hook - Dark Green	USD 36.00	-
MCCTRH-PLUM	Extra Coat Hook - Plum	USD 36.00	-

COMPILE BOOKEND

FOR MORE INFORMATION,
EXPLORE BELOW

[↗ Product Fact Sheet](#)

[↗ Images](#)

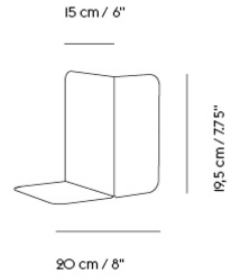

Shipper Colli 1
Gross Weight (kg) 1.026
Net Weight (kg) 0.8
Warranty Period 5 years

Pattern No.	Color	Contract Price	Lead Time
Ready-To-Ship US Warehouse			
MCOMBK-GNBE	Beige-Green	USD 58.00	-
MCOMBK-GREY	Grey	USD 58.00	-
MCOMBK-PLUM	Plum	USD 58.00	-

CORKY SERIES

FOR MORE INFORMATION,
EXPLORE BELOW

- [↗ Product Fact Sheet](#)
- [↗ Images](#)
- [↗ Product Declaration](#)

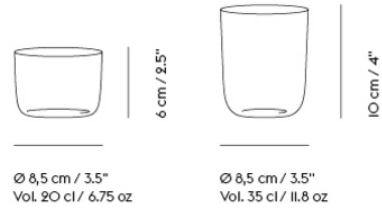

Shipper Colli 1
Gross Weight (kg) 0.7
Net Weight (kg) 0.66
Warranty Period 5 years

Pattern No.	Color	Contract Price	Lead Time
Ready-To-Ship US Warehouse			
MCRKGLL-CLR	Clear - Low	USD 89.00	-
MCRKGLL-GREY	Grey - Low	USD 89.00	-
MCRKGLT-CLR	Clear - Tall	USD 100.00	-
MCRKGLT-GREY	Grey - Tall	USD 100.00	-

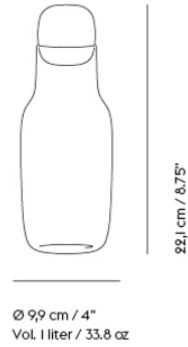

Shipper Colli |
 Gross Weight (kg) |
 Net Weight (kg) 0.4
 Warranty Period 5 years

Pattern No.	Color	Contract Price	Lead Time
Ready-To-Ship US Warehouse			
MCRKCF-CLR	Clear	USD 100.00	-
MCRKCF-GREY	Grey	USD 100.00	-

DOTS SERIES

FOR MORE INFORMATION,
EXPLORE BELOW

- ↗ [Product Fact Sheet](#)
- ↗ [Images](#)
- ↗ [Architect Files](#)
- ↗ [Assembly Instructions](#)
- ↗ [Product Planner](#)

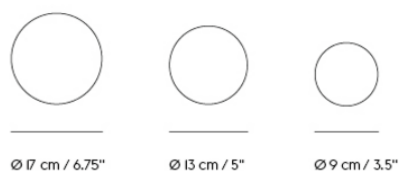
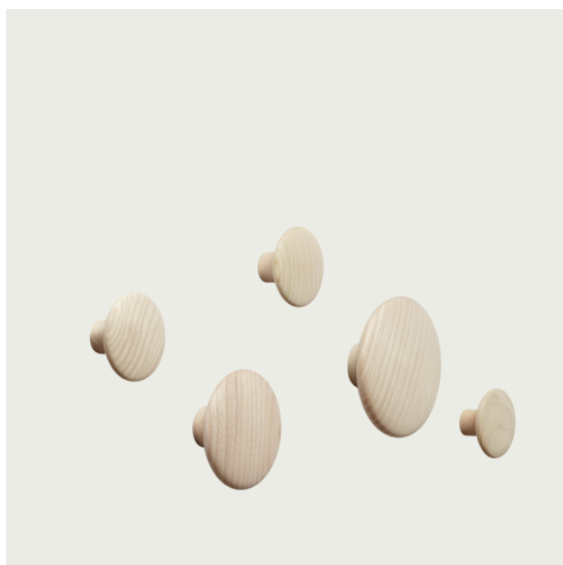

Shipper Colli 1
Gross Weight (kg) 1.2
Net Weight (kg) 0.77
Set of 5 Consists of 1x Ø 17 cm / 6.75", 1x Ø 13 cm / 5" and 3x Ø 9 cm / 3.5"
Warranty Period 5 years

Pattern No.	Color	Contract Price	Lead Time
Ready-To-Ship US Warehouse			
MDOTSWSET-BLCK	Black	USD 156.00	-
MDOTSWSET-GREY	Grey ***	USD 156.00	-
MDOTSWSET-OAK	Oak	USD 156.00	-
MDOTSWSET-OWHT	Off-White	USD 156.00	-
Extras			
MDOTSWC	Screw for Dots Wood and Ceramic	USD 2.00	-

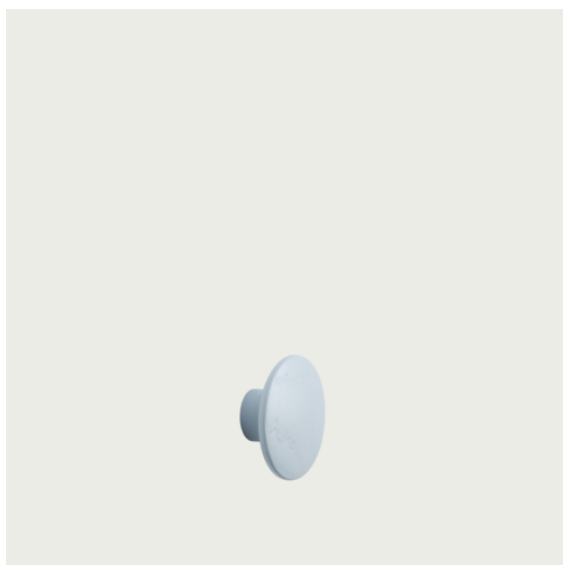

Ø 6,5 cm / 2.5"

Shipper Colli 1
Gross Weight (kg) 0.06
Net Weight (kg) 0.036
Warranty Period 5 years

Pattern No.	Color	Contract Price	Lead Time
Ready-To-Ship US Warehouse			
MDOTSW3-ASH	Ash	USD 27.00	-
MDOTSW3-BLCK	Black	USD 27.00	-
MDOTSW3-BRGR	Brown Green	USD 27.00	-
MDOTSW3-BURG	Burgundy	USD 27.00	-
MDOTSW3-BORG	Burnt Orange	USD 27.00	-
MDOTSW3-DKGN	Dark Green	USD 27.00	-
MDOTSW3-DKGY	Dark Grey	USD 27.00	-
MDOTSW3-DGRN	Dusty Green	USD 27.00	-
MDOTSW3-GREY	Grey ***	USD 27.00	-
MDOTSW3-LTBU	Light Blue	USD 27.00	-
MDOTSW3-MBLU	Midnight Blue	USD 27.00	-
MDOTSW3-MSTD	Mustard	USD 27.00	-
MDOTSW3-OAK	Oak	USD 27.00	-
MDOTSW3-OWHT	Off-White	USD 27.00	-
MDOTSW3-PABU	Pale Blue	USD 27.00	-
MDOTSW3-PETR	Petroleum	USD 27.00	-
MDOTSW3-SAGN	Sage Green ***	USD 27.00	-
MDOTSW3-STDB	Stained Dark Brown	USD 27.00	-
MDOTSW3-TAUP	Taupe	USD 27.00	-
MDOTSW3-WHIT	White ***	USD 27.00	-
MDOTSW3-WALN	Walnut	USD 39.00	-

Pattern No.	Color	Contract Price	Lead Time
Extras			
MDOTSWC	Screw for Dots Wood and Ceramic	USD 2.00	-

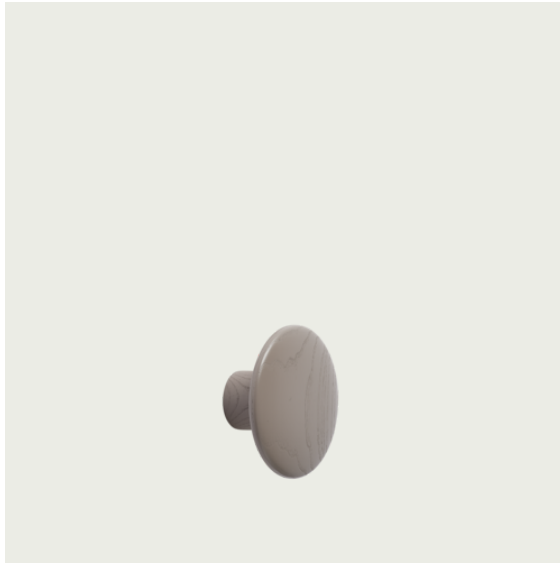

Ø 9 cm / 3.5"

Shipper Colli 1
Gross Weight (kg) 0.123
Net Weight (kg) 0.08
Warranty Period 5 years

Pattern No.	Color	Contract Price	Lead Time
Ready-To-Ship US Warehouse			
MDOTSW4-ASH	Ash	USD 32.00	-
MDOTSW4-BLCK	Black	USD 32.00	-
MDOTSW4-BRGR	Brown Green	USD 32.00	-
MDOTSW4-BURG	Burgundy	USD 32.00	-
MDOTSW4-BORG	Burnt Orange	USD 32.00	-
MDOTSW4-DKGN	Dark Green	USD 32.00	-
MDOTSW4-DKGY	Dark Grey	USD 32.00	-
MDOTSW4-DGRN	Dusty Green	USD 32.00	-
MDOTSW4-GREY	Grey	USD 32.00	-
MDOTSW4-LTBU	Light Blue	USD 32.00	-
MDOTSW4-MBLU	Midnight Blue	USD 32.00	-
MDOTSW4-OAK	Oak	USD 32.00	-
MDOTSW4-OWHT	Off-White	USD 32.00	-
MDOTSW4-PABU	Pale Blue	USD 32.00	-
MDOTSW4-SAGN	Sage Green ***	USD 32.00	-
MDOTSW4-STDB	Stained Dark Brown	USD 32.00	-
MDOTSW4-TAUP	Taupe	USD 32.00	-
MDOTSW4-WHIT	White ***	USD 32.00	-
Extras			
MDOTSWC	Screw for Dots Wood and Ceramic	USD 2.00	-

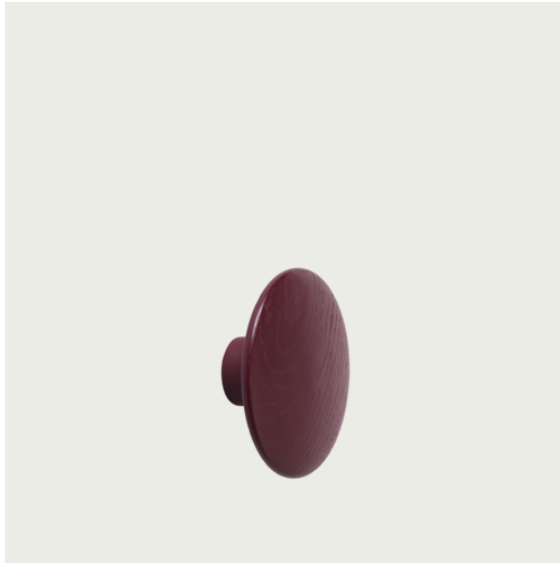

Ø 13 cm / 5"

Shipper Colli 1
Gross Weight (kg) 0.3
Net Weight (kg) 0.25
Warranty Period 5 years

Pattern No.	Color	Contract Price	Lead Time
Ready-To-Ship US Warehouse			
MDOTSW5-ASH	Ash	USD 39.00	-
MDOTSW5-BLCK	Black	USD 39.00	-
MDOTSW5-BRGR	Brown Green	USD 39.00	-
MDOTSW5-BURG	Burgundy	USD 39.00	-
MDOTSW5-BORG	Burnt Orange	USD 39.00	-
MDOTSW5-DKGN	Dark Green	USD 39.00	-
MDOTSW5-DKGY	Dark Grey	USD 39.00	-
MDOTSW5-DGRN	Dusty Green	USD 39.00	-
MDOTSW5-GREY	Grey ***	USD 39.00	-
MDOTSW5-LTBU	Light Blue	USD 39.00	-
MDOTSW5-MBLU	Midnight Blue	USD 39.00	-
MDOTSW5-OAK	Oak	USD 39.00	-
MDOTSW5-OWHT	Off-White	USD 39.00	-
MDOTSW5-PABU	Pale Blue	USD 39.00	-
MDOTSW5-PETR	Petroleum	USD 39.00	-
MDOTSW5-SAGN	Sage Green	USD 39.00	-
MDOTSW5-STDB	Stained Dark Brown	USD 39.00	-
MDOTSW5-TAUP	Taupe	USD 39.00	-
MDOTSW5-WHIT	White ***	USD 39.00	-
MDOTSW5-WALN	Walnut ***	USD 68.00	-

Pattern No.	Color	Contract Price	Lead Time
Ready-To-Ship EU Warehouse			
MDOTSW5-BEGN	Beige-Green ***	USD 39.00	-
Extras			
MDOTSWC	Screw for Dots Wood and Ceramic	USD 2.00	-

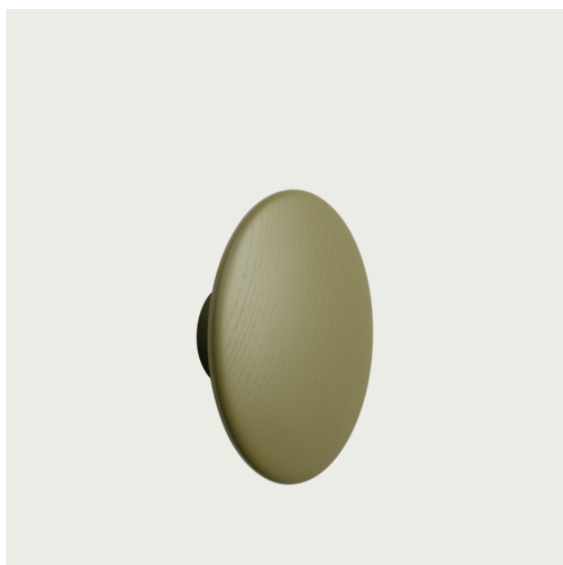

Ø 17 cm / 6.75"

Shipper Colli 1
Gross Weight (kg) 0.5
Net Weight (kg) 0.4
Warranty Period 5 years

Pattern No.	Color	Contract Price	Lead Time
Ready-To-Ship US Warehouse			
MDOTSW7-ASH	Ash	USD 42.00	-
MDOTSW7-BLCK	Black	USD 42.00	-
MDOTSW7-BRGR	Brown Green	USD 42.00	-
MDOTSW7-BURG	Burgundy	USD 42.00	-
MDOTSW7-BORG	Burnt Orange	USD 42.00	-
MDOTSW7-DKGN	Dark Green	USD 42.00	-
MDOTSW7-DKGY	Dark Grey	USD 42.00	-
MDOTSW7-DGRN	Dusty Green	USD 42.00	-
MDOTSW7-GREY	Grey	USD 42.00	-
MDOTSW7-LTBU	Light Blue	USD 42.00	-
MDOTSW7-MBLU	Midnight Blue	USD 42.00	-
MDOTSW7-MSTD	Mustard ***	USD 42.00	-
MDOTSW7-OAK	Oak	USD 42.00	-
MDOTSW7-OWHT	Off-White	USD 42.00	-
MDOTSW7-PABU	Pale Blue	USD 42.00	-
MDOTSW7-PETR	Petroleum	USD 42.00	-
MDOTSW7-SAGN	Sage Green ***	USD 42.00	-
MDOTSW7-STDB	Stained Dark Brown	USD 42.00	-
MDOTSW7-TAUP	Taupe	USD 42.00	-
MDOTSW7-WHIT	White	USD 42.00	-
MDOTSW7-WALN	Walnut	USD 79.00	-

Pattern No.	Color	Contract Price	Lead Time
Extras			
MDOTSWC	Screw for Dots Wood and Ceramic	USD 2.00	-

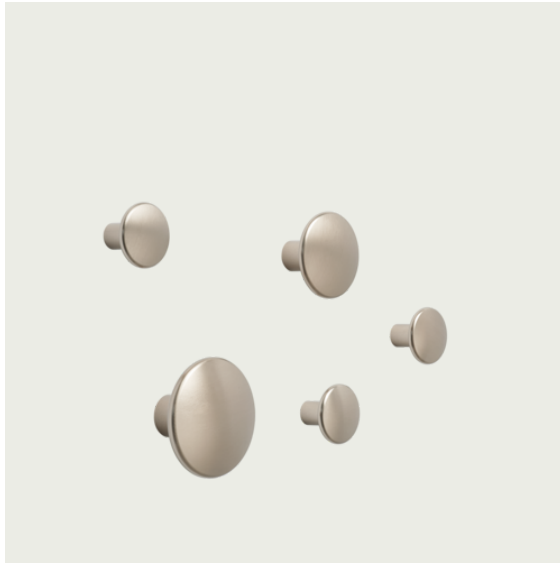

Shipper Colli 1
Gross Weight (kg) 0.485
Net Weight (kg) 0.15
Set of 5 Consists of 1x Ø 5 cm / 2", 1x Ø 3,9 cm / 1.5" and 3x Ø 2,7 cm / 1"
Warranty Period 5 years

Pattern No.	Color	Contract Price	Lead Time
Ready-To-Ship US Warehouse			
MDOTSMSET-ALUM	Aluminum	USD 167.00	-
MDOTSMSET-BLCK	Black	USD 167.00	-
MDOTSMSET-BRAS	Brass	USD 167.00	-
MDOTSMSET-PABU	Pale Blue ***	USD 167.00	-
MDOTSMSET-TAUP	Taupe ***	USD 167.00	-
MDOTSMSET-UMBR	Umber	USD 167.00	-
Ready-To-Ship EU Warehouse			
MDOTSMSET-DKGN	Dark Green	USD 167.00	-
MDOTSMSET-ROSE	Rose	USD 167.00	-
Extras			
MDOTSMSS	Screw for Dots Metal	USD 9.00	-

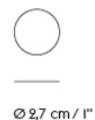
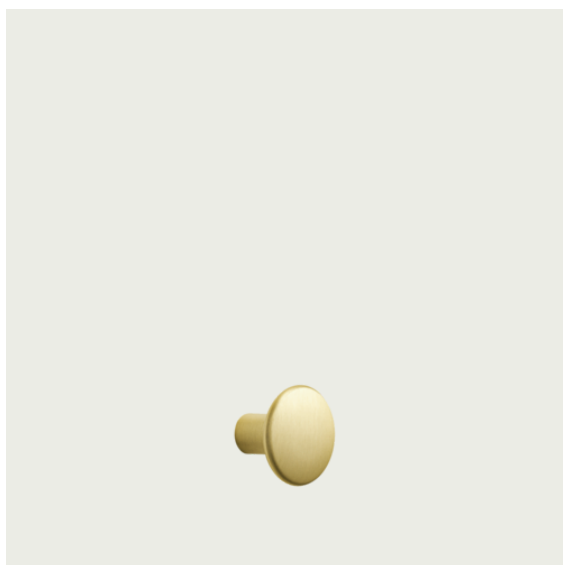

Shipper Colli 1
 Gross Weight (kg) 0.11
 Net Weight (kg) 0.02
 Warranty Period 5 years

Pattern No.	Color	Contract Price	Lead Time
Ready-To-Ship US Warehouse			
MDOTSM1-ALUM	Aluminum	USD 29.00	-
MDOTSM1-BLCK	Black	USD 29.00	-
MDOTSM1-BRAS	Brass	USD 29.00	-
MDOTSM1-DKGN	Dark Green	USD 29.00	-
MDOTSM1-LTGN	Light Green	USD 29.00	-
MDOTSM1-LILC	Lilac	USD 29.00	-
MDOTSM1-PABU	Pale Blue	USD 29.00	-
MDOTSM1-ROSE	Rose	USD 29.00	-
MDOTSM1-TAUP	Taupe	USD 29.00	-
MDOTSM1-UMBR	Umber	USD 29.00	-
Extras			
MDOTSMSS	Screw for Dots Metal	USD 9.00	-

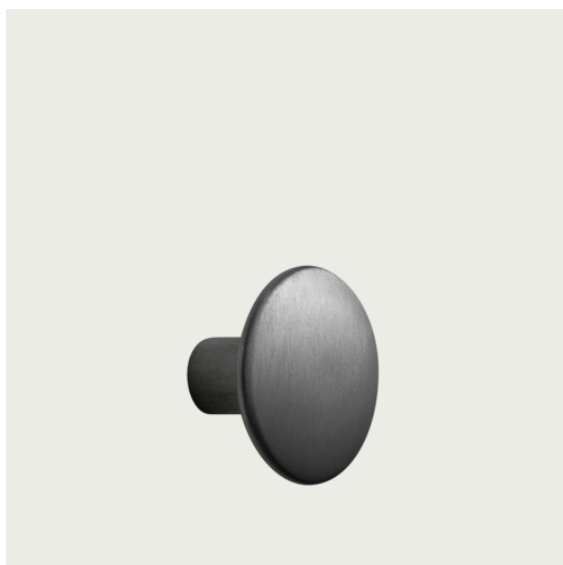

Shipper Colli 1
 Gross Weight (kg) 0.06
 Net Weight (kg) 0.03
 Warranty Period 5 years

Pattern No.	Color	Contract Price	Lead Time
Ready-To-Ship US Warehouse			
MDOTSM15-ALUM	Aluminum	USD 40.00	-
MDOTSM15-BLCK	Black	USD 40.00	-
MDOTSM15-BRAS	Brass	USD 40.00	-
MDOTSM15-DKGN	Dark Green	USD 40.00	-
MDOTSM15-LTGN	Light Green	USD 40.00	-
MDOTSM15-LILC	Lilac	USD 40.00	-
MDOTSM15-PABU	Pale Blue	USD 40.00	-
MDOTSM15-ROSE	Rose	USD 40.00	-
MDOTSM15-TAUP	Taupe	USD 40.00	-
MDOTSM15-UMBR	Umber	USD 40.00	-
Extras			
MDOTSMSS	Screw for Dots Metal	USD 9.00	-

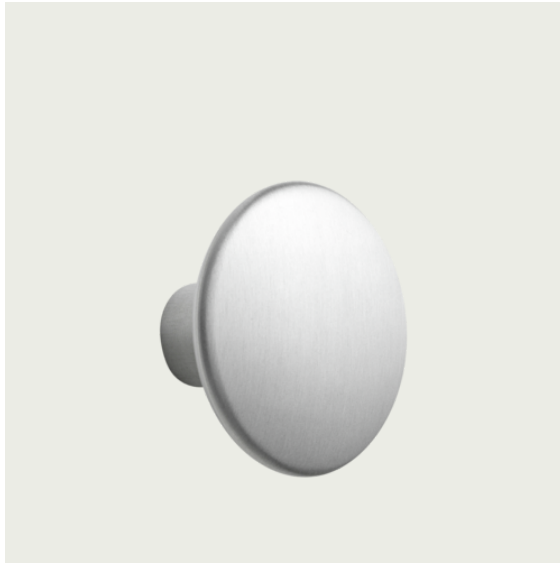

Ø 5 cm / 2"

Shipper Colli 1
Gross Weight (kg) 0.24
Net Weight (kg) 0.07
Warranty Period 5 years

Pattern No.	Color	Contract Price	Lead Time
Ready-To-Ship US Warehouse			
MDOTSM2-ALUM	Aluminum	USD 52.00	-
MDOTSM2-BLCK	Black	USD 52.00	-
MDOTSM2-BRAS	Brass	USD 52.00	-
MDOTSM2-DKGN	Dark Green ***	USD 52.00	-
MDOTSM2-LTGN	Light Green	USD 52.00	-
MDOTSM2-LILC	Lilac	USD 52.00	-
MDOTSM2-PABU	Pale Blue ***	USD 52.00	-
MDOTSM2-ROSE	Rose	USD 52.00	-
MDOTSM2-TAUP	Taupe	USD 52.00	-
MDOTSM2-UMBR	Umber	USD 52.00	-
Extras			
MDOTSMSS	Screw for Dots Metal	USD 9.00	-

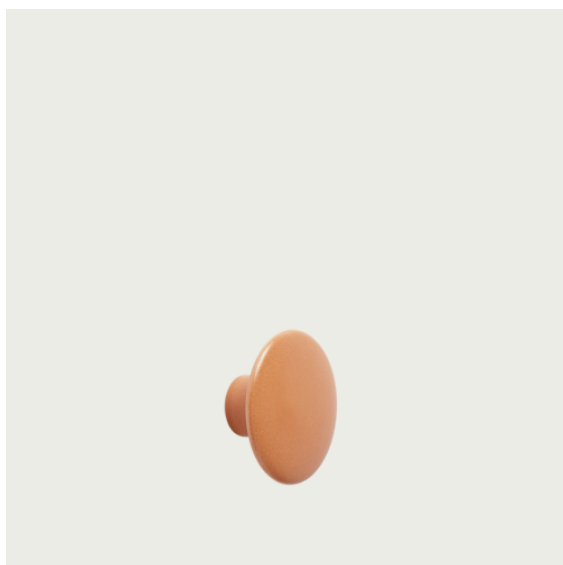

Ø 9 cm / 3.5"

Shipper Colli 1
Gross Weight (kg) 0.2
Net Weight (kg) 0.11
Warranty Period 5 years

Pattern No.	Color	Contract Price	Lead Time
Ready-To-Ship US Warehouse			
MDOTSC4-BORG	Burnt Orange	USD 44.00	-
MDOTSC4-LTBU	Light Blue	USD 44.00	-
MDOTSC4-ROSE	Rose ***	USD 44.00	-
Extras			
MDOTSWC	Screw for Dots Wood and Ceramic	USD 2.00	-

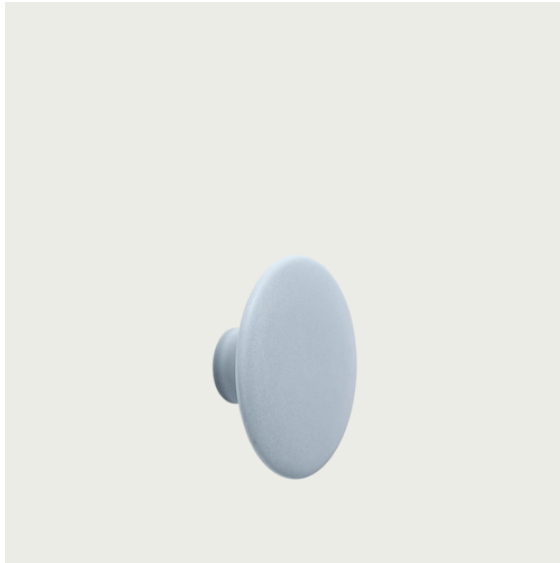

Ø 13 cm / 5"

Shipper Colli 1
Gross Weight (kg) 0.3
Net Weight (kg) 0.225
Warranty Period 5 years

Pattern No.	Color	Contract Price	Lead Time
Ready-To-Ship US Warehouse			
MDOTSC5-BORG	Burnt Orange	USD 58.00	-
MDOTSC5-LTBU	Light Blue	USD 58.00	-
MDOTSC5-ROSE	Rose ***	USD 58.00	-
Extras			
MDOTSWC	Screw for Dots Wood and Ceramic	USD 2.00	-

FOLDED SHELVES

FOR MORE INFORMATION,
EXPLORE BELOW

- ↗ [Product Fact Sheet](#)
- ↗ [Images](#)
- ↗ [Architect Files](#)
- ↗ [Assembly Instructions](#)

FOLDED SHELVES / 29,5 X 40 CM / 11.5 X 15.75"

603

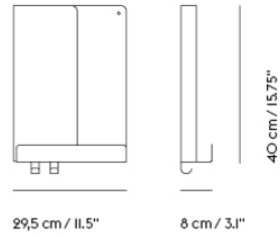

Shipper Colli	1
Gross Weight (kg)	3.5
Net Weight (kg)	2.8
Warranty Period	5 years

Pattern No.	Color	Contract Price	Lead Time
Ready-To-Ship US Warehouse			
MFLDSHXS-BLCK	Black	USD 177.00	-
MFLDSHXS-BUGY	Blue-Grey	USD 177.00	-
MFLDSHXS-BORG	Burnt Orange	USD 177.00	-
MFLDSHXS-DPRD	Deep Red	USD 177.00	-
MFLDSHXS-GREY	Grey	USD 177.00	-
MFLDSHXS-OLIV	Olive	USD 177.00	-

FOLDED SHELVES / 51 X 22 CM / 20 X 8.75"

604

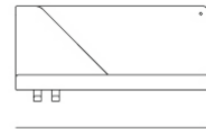

51 cm / 20"

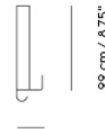

6,9 cm / 2.75"

22 cm / 8.75"

Shipper Colli	1
Gross Weight (kg)	2.9
Net Weight (kg)	2.35
Warranty Period	5 years

Pattern No.	Color	Contract Price	Lead Time
Ready-To-Ship US Warehouse			
MFLDSHSM-BLCK	Black	USD 177.00	-
MFLDSHSM-BUGY	Blue-Grey	USD 177.00	-
MFLDSHSM-BORG	Burnt Orange	USD 177.00	-
MFLDSHSM-DPRD	Deep Red	USD 177.00	-
MFLDSHSM-GREY	Grey	USD 177.00	-
MFLDSHSM-OLIV	Olive	USD 177.00	-

FOLDED SHELVES / 63 X 16,5 CM / 24.75 X 6.5"

605



63 cm / 24.75"



12,4 cm / 4.75"

16,5 cm / 6.5"

Shipper Colli	1
Gross Weight (kg)	3.4
Net Weight (kg)	2.85
Warranty Period	5 years

Pattern No.	Color	Contract Price	Lead Time
Ready-To-Ship US Warehouse			
MFLDSHMD-BLCK	Black	USD 251.00	-
MFLDSHMD-BUGY	Blue-Grey	USD 251.00	-
MFLDSHMD-BORG	Burnt Orange	USD 251.00	-
MFLDSHMD-DPRD	Deep Red	USD 251.00	-
MFLDSHMD-GREY	Grey	USD 251.00	-
MFLDSHMD-OLIV	Olive	USD 251.00	-



96 cm / 37.75"



13 cm / 5"

Shipper Colli	1
Gross Weight (kg)	4.2
Net Weight (kg)	3.55
Warranty Period	5 years

Pattern No.	Color	Contract Price	Lead Time
Ready-To-Ship US Warehouse			
MFLDShLG-BLCK	Black	USD 324.00	-
MFLDShLG-BUGY	Blue-Grey	USD 324.00	-
MFLDShLG-BORG	Burnt Orange	USD 324.00	-
MFLDShLG-DPRD	Deep Red	USD 324.00	-
MFLDShLG-GREY	Grey	USD 324.00	-
MFLDShLG-OLIV	Olive	USD 324.00	-

FOLDED PLATFORM SHELF

607

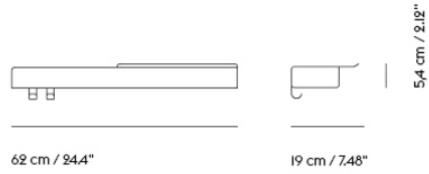

Shipper Colli	1
Gross Weight (kg)	3.1
Net Weight (kg)	2.3
Warranty Period	5 years

Pattern No.	Color	Contract Price	Lead Time
Ready-To-Ship US Warehouse			
MFLDSHPLT-BLCK	Black	USD 324.00	-
MFLDSHPLT-BUGY	Blue-Grey	USD 324.00	-
MFLDSHPLT-BORG	Burnt Orange	USD 324.00	-
MFLDSHPLT-DPRD	Deep Red	USD 324.00	-
MFLDSHPLT-GREY	Grey	USD 324.00	-
MFLDSHPLT-OLIV	Olive	USD 324.00	-

FRAMED MIRROR

FOR MORE INFORMATION,
EXPLORE BELOW

- ↗ [Product Fact Sheet](#)
- ↗ [Images](#)
- ↗ [Architect Files](#)
- ↗ [Assembly Instructions](#)

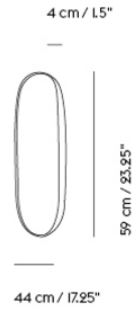
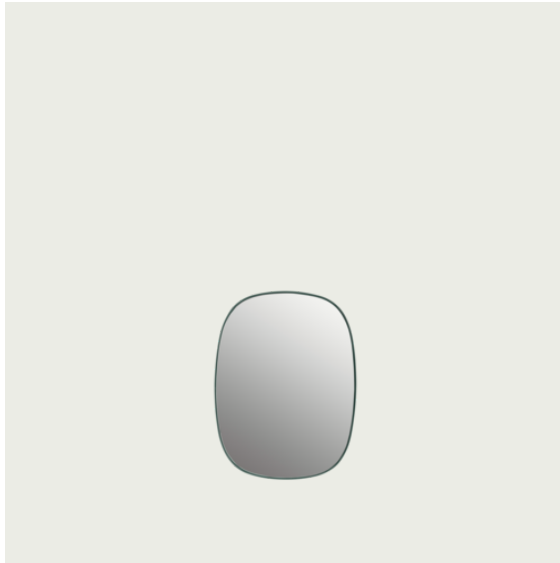

Shipper Colli 1
 Gross Weight (kg) 8.5
 Net Weight (kg) 5.5
 Warranty Period 5 years

Pattern No.	Color	Contract Price	Lead Time
Ready-To-Ship US Warehouse			
MFRMMIRSM-ROSECL	Rose/Clear	USD 450.00	-
MFRMMIRSM-DKGNCL	Dark Green/Clear	USD 450.00	-
MFRMMIRSM-GREYCL	Grey/Clear	USD 450.00	-
MFRMMIRSM-ROSERE	Rose/Rose	USD 450.00	-
MFRMMIRSM-TAUPCL	Taupe/Clear	USD 450.00	-
MFRMMIRSM-TAUPTP	Taupe/Taupe	USD 450.00	-

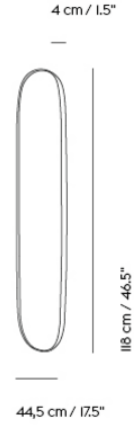

Shipper Colli 1
Gross Weight (kg) 16.2
Net Weight (kg) 11.8
Warranty Period 5 years

Pattern No.	Color	Contract Price	Lead Time
Ready-To-Ship US Warehouse			
MFRMMIRLG-ROSECL	Rose/Clear	USD 849.00	-
MFRMMIRLG-DKGNCL	Dark Green/Clear	USD 849.00	-
MFRMMIRLG-GREYCL	Grey/Clear	USD 849.00	-
MFRMMIRLG-ROSERE	Rose/Rose	USD 849.00	-
MFRMMIRLG-TAUPCL	Taupe/Clear	USD 849.00	-
MFRMMIRLG-TAUPTP	Taupe/Taupe	USD 849.00	-

GROOVE TRIVET

FOR MORE INFORMATION,
EXPLORE BELOW

- ↗ [Product Fact Sheet](#)
- ↗ [Images](#)
- ↗ [Architect Files](#)

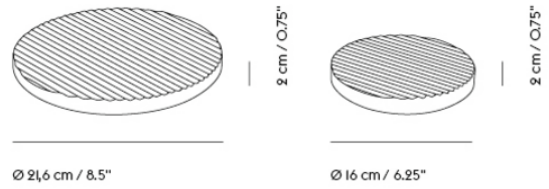

Shipper Colli |
Gross Weight (kg) 1.45
Net Weight (kg) 1.3
Warranty Period 5 years

Pattern No.	Color	Contract Price	Lead Time
Ready-To-Ship EU Warehouse			
MGRVT6-GREN	Green - Ø 16 cm / 6.25"	USD 72.00	-
MGRVT6-GREY	Grey - Ø 16 cm / 6.25"	USD 72.00	-
MGRVT9-GREN	Green - Ø 21,6 cm / 8.5"	USD 100.00	-
MGRVT9-GREY	Grey - Ø 21,6 cm / 8.5"	USD 100.00	-

KINK VASE

FOR MORE INFORMATION,
EXPLORE BELOW

- ↗ [Product Fact Sheet](#)
- ↗ [Images](#)
- ↗ [Architect Files](#)

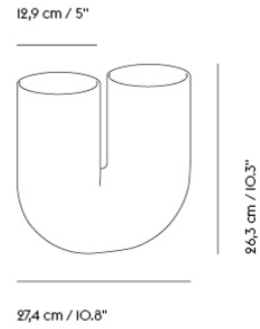

Shipper Colli 1
Gross Weight (kg) 2.4
Net Weight (kg) 1.946
Warranty Period 5 years

Pattern No.	Color	Contract Price	Lead Time
Ready-To-Ship US Warehouse			
MKINVS-DPRD	Deep Red	USD 303.00	-
MKINVS-DLIL	Dusty Lilac	USD 303.00	-
MKINVS-LTBU	Light Blue	USD 303.00	-
MKINVS-LTGN	Light Green	USD 303.00	-
MKINVS-SAND	Sand	USD 303.00	-

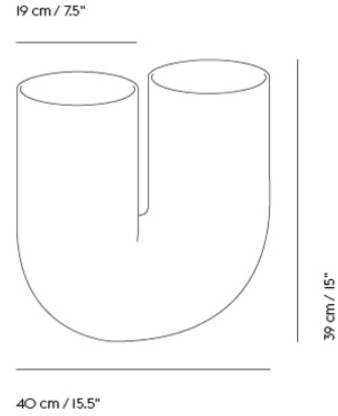

Shipper Colli 1
Gross Weight (kg) 4.9
Net Weight (kg) 4.1
Warranty Period 5 years

Pattern No.	Color	Contract Price	Lead Time
Ready-To-Ship US Warehouse			
MKINVS15-SAND	Sand	USD 660.00	-

LAYER CUSHION

FOR MORE INFORMATION,
EXPLORE BELOW

[↗ Product Fact Sheet](#)

[↗ Images](#)

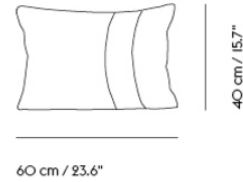

Shipper Colli 1
 Gross Weight (kg) 0.65
 Net Weight (kg) 0.6
 Warranty Period 5 years

Pattern No.	Color	Contract Price	Lead Time
Ready-To-Ship US Warehouse			
MLAYCUS1624-DKGN	Dark Green ***	USD 146.00	-
MLAYCUS1624-DKGY	Dark Grey ***	USD 146.00	-
MLAYCUS1624-SDGY	Sand-Grey ***	USD 146.00	-

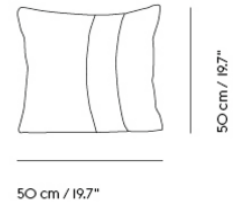

Shipper Colli 1
Gross Weight (kg) 0.65
Net Weight (kg) 0.6
Warranty Period 5 years

Pattern No.	Color	Contract Price	Lead Time
Ready-To-Ship US Warehouse			
MLAYCUS2020-DKGY	Dark Grey ***	USD 146.00	-
MLAYCUS2020-DROS	Dusty Rose ***	USD 146.00	-
MLAYCUS2020-MBLU	Midnight Blue ***	USD 146.00	-
MLAYCUS2020-SDGY	Sand-Grey ***	USD 146.00	-
Ready-To-Ship EU Warehouse			
MLAYCUS2020-DKGN	Dark Green ***	USD 146.00	-

MERE BOWL

FOR MORE INFORMATION,
EXPLORE BELOW

- ↗ [Product Fact Sheet](#)
- ↗ [Images](#)
- ↗ [Architect Files](#)
- ↗ [Product Declaration](#)

MERE BOWL / 51,5 X 21,5 CM / 20.5 X 8.5"

620

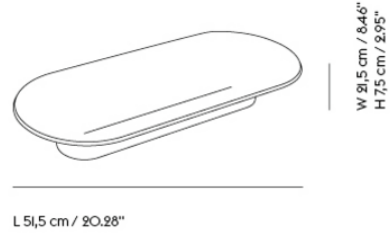

Shipper Colli	1
Gross Weight (kg)	3
Net Weight (kg)	2.3
Warranty Period	5 years

Pattern No.	Color	Contract Price	Lead Time
Ready-To-Ship US Warehouse			
MMERBWL2109-BRGR	Brown Green	USD 226.00	-
MMERBWL2109-LTGN	Light Green	USD 226.00	-
MMERBWL2109-OWHT	Off-White	USD 226.00	-

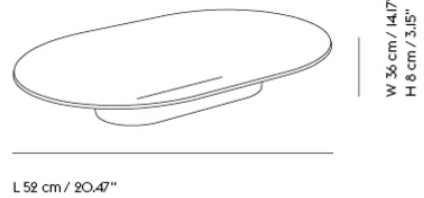

Shipper Colli	1
Gross Weight (kg)	4.2
Net Weight (kg)	3.1
Warranty Period	5 years

Pattern No.	Color	Contract Price	Lead Time
Ready-To-Ship US Warehouse			
MMERBWL2115-BRGR	Brown Green	USD 278.00	-
MMERBWL2115-LTGN	Light Green	USD 278.00	-
MMERBWL2115-OWHT	Off-White	USD 278.00	-

MINGLE CUSHION

FOR MORE INFORMATION,
EXPLORE BELOW

- ↗ [Product Fact Sheet](#)
- ↗ [Images](#)
- ↗ [Architect Files](#)
- ↗ [Assembly Instructions](#)

MINGLE CUSHION / 45 X 45 CM / 17.7 X 17.7"

623

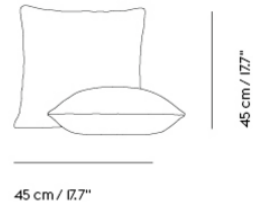

Shipper Colli	1
Gross Weight (kg)	0.541
Net Weight (kg)	0.534
Warranty Period	5 years

Pattern No.	Color	Contract Price	Lead Time
Ready-To-Ship US Warehouse			
MMNGCUS1818-CPBNLTBU	Copper Brown / Light Blue	USD 163.00	-
MMNGCUS1818-LTBUMINT	Light Blue / Mint	USD 163.00	-
MMNGCUS1818-LIGN	Light Green	USD 163.00	-
MMNGCUS1818-LIYW	Light Yellow	USD 163.00	-
MMNGCUS1818-MBLU	Midnight Blue	USD 163.00	-
MMNGCUS1818-PETRROSE	Rose / Petroleum	USD 163.00	-
MMNGCUS1818-SANDLILC	Sand / Lilac	USD 163.00	-
MMNGCUS1818-TAUP	Taupe	USD 163.00	-

MINGLE CUSHION / 35 X 55 CM / 13.7 X 21.7"

624



Shipper Colli |
Gross Weight (kg) 0.539
Net Weight (kg) 0.532
Warranty Period 5 years

Pattern No.	Color	Contract Price	Lead Time
Ready-To-Ship US Warehouse			
MMNGCUS1422-CPBNLTBU	Copper Brown / Light Blue	USD 163.00	-
MMNGCUS1422-LTBUMINT	Light Blue / Mint	USD 163.00	-
MMNGCUS1422-LIGN	Light Green	USD 163.00	-
MMNGCUS1422-LIYW	Light Yellow	USD 163.00	-
MMNGCUS1422-MBLU	Midnight Blue	USD 163.00	-
MMNGCUS1422-PETROSE	Rose / Petroleum	USD 163.00	-
MMNGCUS1422-SANDLILC	Sand / Lilac	USD 163.00	-
MMNGCUS1422-TAUP	Taupe	USD 163.00	-

PEBBLE RUG

FOR MORE INFORMATION,
EXPLORE BELOW

- ↗ [Product Fact Sheet](#)
- ↗ [Images](#)
- ↗ [Product Declaration](#)
- ↗ [Assembly Instructions](#)

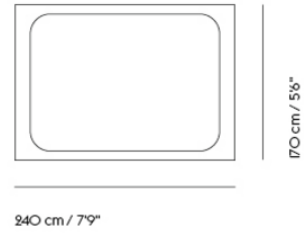

Shipper Colli 1
Gross Weight (kg) 18.4
Net Weight (kg) 17.8
Warranty Period 5 years

Pattern No.	Color	Contract Price	Lead Time
Ready-To-Ship US Warehouse			
MPEBRG6693-BRGR	Brown Green	USD 1,675.00	-
MPEBRG6693-BORG	Burnt Orange	USD 1,675.00	-
MPEBRG6693-DKGY	Dark Grey	USD 1,675.00	-
MPEBRG6693-LTGY	Light Grey	USD 1,675.00	-
MPEBRG6693-PABU	Pale Blue	USD 1,675.00	-
MPEBRG6693-PROS	Pale Rose	USD 1,675.00	-

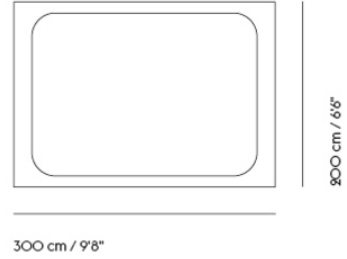

Shipper Colli 1
Gross Weight (kg) 24.3
Net Weight (kg) 22.1
Warranty Period 5 years

Pattern No.	Color	Contract Price	Lead Time
Ready-To-Ship US Warehouse			
MPEBRG78116-BRGR	Brown Green	USD 2,620.00	-
MPEBRG78116-BORG	Burnt Orange	USD 2,620.00	-
MPEBRG78116-LTGY	Light Grey	USD 2,620.00	-
MPEBRG78116-PABU	Pale Blue	USD 2,620.00	-
MPEBRG78116-PROS	Pale Rose	USD 2,620.00	-

PLATFORM TRAY

FOR MORE INFORMATION,
EXPLORE BELOW

- ↗ [Product Fact Sheet](#)
- ↗ [Images](#)
- ↗ [Architect Files](#)
- ↗ [Assembly Instructions](#)

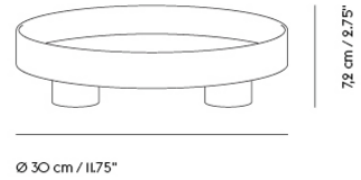

Shipper Colli 1
 Gross Weight (kg) 0.9
 Net Weight (kg) 0.65
 Warranty Period 5 years

Pattern No.	Color	Contract Price	Lead Time
Ready-To-Ship US Warehouse			
MPLTTY-BUGY	Blue Grey	USD 114.00	-
MPLTTY-DKGN	Dark Green	USD 114.00	-
MPLTTY-DKRD	Dark Red	USD 114.00	-
MPLTTY-GREY	Grey	USD 114.00	-

PLY RUG SERIES

FOR MORE INFORMATION,
EXPLORE BELOW

- [↗ Product Fact Sheet](#)
- [↗ Images](#)
- [↗ Product Declaration](#)

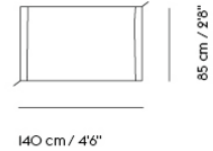

Shipper Colli 1
Gross Weight (kg) 3.4
Net Weight (kg) 2.9
Warranty Period 5 years

Pattern No.	Color	Contract Price	Lead Time
Ready-To-Ship US Warehouse			
MPLYRG3254-BLWH	Black/White	USD 356.00	-
MPLYRG3254-BORG	Burnt Orange	USD 356.00	-
MPLYRG3254-DKGY	Dark Grey ***	USD 356.00	-
MPLYRG3254-GREY	Grey	USD 356.00	-
MPLYRG3254-LROS	Light Rose	USD 356.00	-
MPLYRG3254-MBLU	Midnight Blue ***	USD 356.00	-
MPLYRG3254-OWHT	Off-White	USD 356.00	-
MPLYRG3254-ROSE	Rose ***	USD 356.00	-
MPLYRG3254-YELW	Yellow	USD 356.00	-
Extras			
MPLYPA3254	Rug Pad - 75 x 130 cm / 2'5 x 4'3"	USD 44.00	-

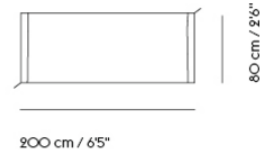

Shipper Colli 1
Gross Weight (kg) 3.8
Net Weight (kg) 2.9
Warranty Period 5 years

Pattern No.	Color	Contract Price	Lead Time
Ready-To-Ship US Warehouse			
MPLYRG3077-BLWH	Black/White	USD 450.00	-
MPLYRG3077-BORG	Burnt Orange	USD 450.00	-
MPLYRG3077-DKGY	Dark Grey ***	USD 450.00	-
MPLYRG3077-GREY	Grey	USD 450.00	-
MPLYRG3077-LROS	Light Rose	USD 450.00	-
MPLYRG3077-MBLU	Midnight Blue ***	USD 450.00	-
MPLYRG3077-OWHT	Off-White	USD 450.00	-
MPLYRG3077-ROSE	Rose ***	USD 450.00	-
MPLYRG3077-YELW	Yellow	USD 450.00	-
Extras			
MPLYPA3077	Rug Pad - 70 x 190 cm / 2'3 x 6'2"	USD 68.00	-

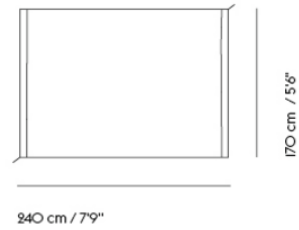

Shipper Colli 1
Gross Weight (kg) 10.5
Net Weight (kg) 8.6
Warranty Period 5 years

Pattern No.	Color	Contract Price	Lead Time
Ready-To-Ship US Warehouse			
MPLYRG6681-BLWH	Black/White	USD 1,028.00	-
MPLYRG6681-BORG	Burnt Orange	USD 1,028.00	-
MPLYRG6681-DKGY	Dark Grey ***	USD 1,028.00	-
MPLYRG6681-GREY	Grey	USD 1,028.00	-
MPLYRG6681-LROS	Light Rose	USD 1,028.00	-
MPLYRG6681-MBLU	Midnight Blue	USD 1,028.00	-
MPLYRG6681-OWHT	Off-White	USD 1,028.00	-
MPLYRG6681-ROSE	Rose	USD 1,028.00	-
MPLYRG6681-YELW	Yellow	USD 1,028.00	-
Extras			
MPLYPA6681	Rug Pad - 160 x 230 cm / 5'2 x 7'5"	USD 89.00	-

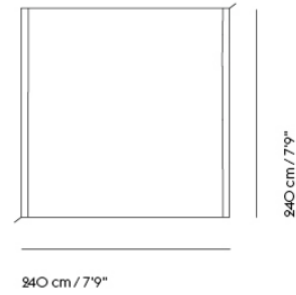

Shipper Colli 1
Gross Weight (kg) 16.2
Net Weight (kg) 15.55
Warranty Period 5 years

Pattern No.	Color	Contract Price	Lead Time
Ready-To-Ship US Warehouse			
MPLYRG8181-BLWH	Black/White	USD 1,360.00	-
MPLYRG8181-BORG	Burnt-Orange	USD 1,360.00	-
MPLYRG8181-GREY	Grey	USD 1,360.00	-
MPLYRG8181-LROS	Light Rose	USD 1,360.00	-
MPLYRG8181-OWHT	Off-White	USD 1,360.00	-
MPLYRG8181-YELW	Yellow	USD 1,360.00	-

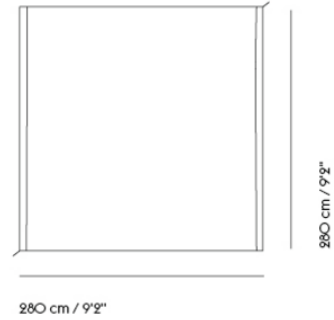

Shipper Colli 1
Gross Weight (kg) 22
Net Weight (kg) 21.2
Warranty Period 5 years

Pattern No.	Color	Contract Price	Lead Time
Ready-To-Ship US Warehouse			
MPLYRG110110-BLWH	Black-White	USD 1,885.00	-
MPLYRG110110-BORG	Burnt Orange	USD 1,885.00	-
MPLYRG110110-GREY	Grey	USD 1,885.00	-
MPLYRG110110-LROS	Light Rose	USD 1,885.00	-
MPLYRG110110-OWHT	Off-White	USD 1,885.00	-
MPLYRG110110-YELW	Yellow	USD 1,885.00	-

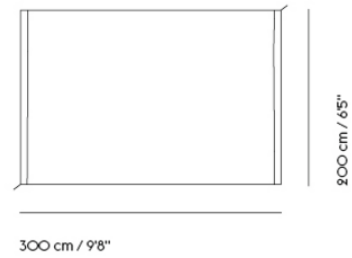

Shipper Colli 1
Gross Weight (kg) 14.7
Net Weight (kg) 12.8
Warranty Period 5 years

Pattern No.	Color	Contract Price	Lead Time
Ready-To-Ship US Warehouse			
MPLYRG78116-BLWH	Black/White	USD 1,626.00	-
MPLYRG78116-BORG	Burnt Orange	USD 1,626.00	-
MPLYRG78116-DKGY	Dark Grey	USD 1,626.00	-
MPLYRG78116-GREY	Grey	USD 1,626.00	-
MPLYRG78116-LROS	Light Rose	USD 1,626.00	-
MPLYRG78116-MBLU	Midnight Blue ***	USD 1,626.00	-
MPLYRG78116-OWHT	Off-White	USD 1,626.00	-
MPLYRG78116-ROSE	Rose	USD 1,626.00	-
MPLYRG78116-YELW	Yellow	USD 1,626.00	-
Extras			
MPLYPA78116	Rug Pad - 190 x 290 cm / 6'2 x 9'5"	USD 110.00	-



Shipper Colli 1
Gross Weight (kg) 24.3
Net Weight (kg) 20.6
Warranty Period 5 years

Pattern No.	Color	Contract Price	Lead Time
Ready-To-Ship US Warehouse			
MPLYRG104140-BLWH	Black/White	USD 2,571.00	-
MPLYRG104140-DKGY	Dark Grey ***	USD 2,571.00	-
MPLYRG104140-GREY	Grey	USD 2,571.00	-
MPLYRG104140-LROS	Light Rose	USD 2,571.00	-
MPLYRG104140-OWHT	Off-White	USD 2,571.00	-
MPLYRG104140-ROSE	Rose ***	USD 2,571.00	-
MPLYRG104140-YELW	Yellow	USD 2,571.00	-
Extras			
MPLYPA104140	Rug Pad - 260 x 350 cm / 8'5 x 11'5"	USD 226.00	-

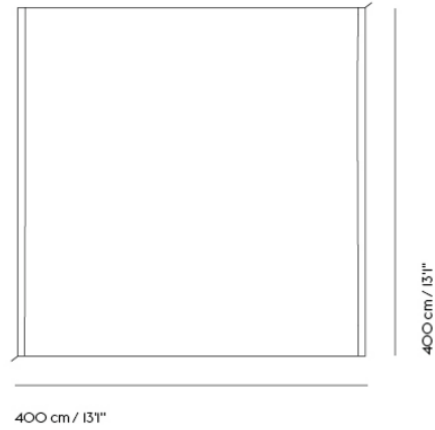

Shipper Colli 1
Gross Weight (kg) 42.8
Net Weight (kg) 34.1
Warranty Period 5 years

Pattern No.	Color	Contract Price	Lead Time
Ready-To-Ship US Warehouse			
MPLYRG157157-MBLU	Midnight Blue ***	USD 4,090.00	-
MPLYRG157157-OWHT	Off-White ***	USD 4,090.00	-
MPLYRG157157-ROSE	Rose ***	USD 4,090.00	-
Extras			
MPLYPA157157	Rug Pad - 380 x 380 cm / 12'5 x 12'5" ***	USD 345.00	-

**PLY RUG / RECYCLED POLYESTER / 140 X
85 CM / 55 X 33"**

639

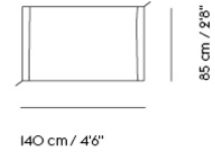
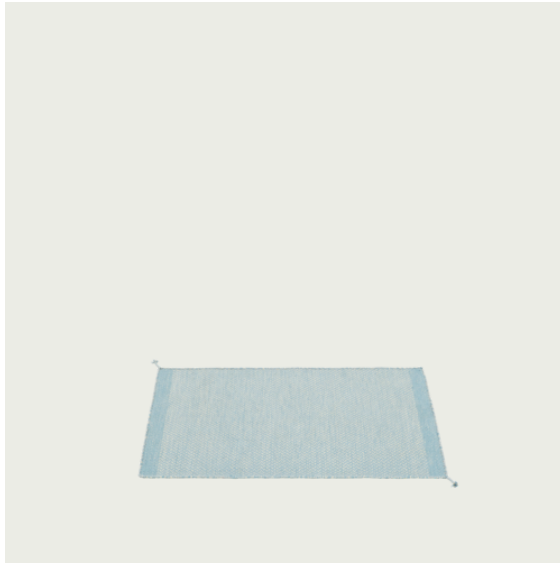

Shipper Colli 1
Gross Weight (kg) 5.2
Net Weight (kg) 3.2
Warranty Period 5 years

Pattern No.	Color	Contract Price	Lead Time
Ready-To-Ship US Warehouse			
MPLYRGRP3254-BLWH	Black/White	USD 356.00	-
MPLYRGRP3254-LTBU	Light Blue	USD 356.00	-
MPLYRGRP3254-MSGN	Moss Green	USD 356.00	-
MPLYRGRP3254-OWHT	Off-White	USD 356.00	-

**PLY RUG / RECYCLED POLYESTER / 200 X
80 CM / 79 X 31"**

640

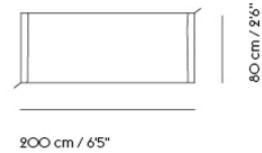

Shipper Colli 1
Gross Weight (kg) 6.3
Net Weight (kg) 4.3
Warranty Period 5 years

Pattern No.	Color	Contract Price	Lead Time
Ready-To-Ship US Warehouse			
MPLYRGRP3077-BLWH	Black/White	USD 450.00	-
MPLYRGRP3077-LTBU	Light Blue	USD 450.00	-
MPLYRGRP3077-MSGN	Moss Green	USD 450.00	-
MPLYRGRP3077-OWHT	Off-White	USD 450.00	-

PLY RUG / RECYCLED POLYESTER / 240 X 170 CM / 94 X 67"

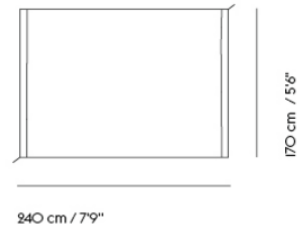

Shipper Colli 1
Gross Weight (kg) 13
Net Weight (kg) 11
Warranty Period 5 years

Pattern No.	Color	Contract Price	Lead Time
Ready-To-Ship US Warehouse			
MPLYRGRP6681-BLWH	Black/White	USD 1,028.00	-
MPLYRGRP6681-LTBU	Light Blue	USD 1,028.00	-
MPLYRGRP6681-MSGN	Moss Green	USD 1,028.00	-
MPLYRGRP6681-OWHT	Off-White	USD 1,028.00	-

PLY RUG / RECYCLED POLYESTER / 300 X 200 CM / 118 X 79"

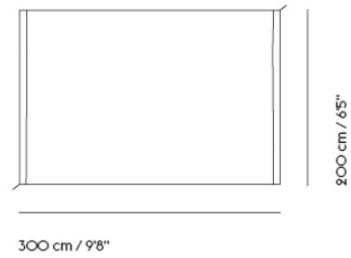
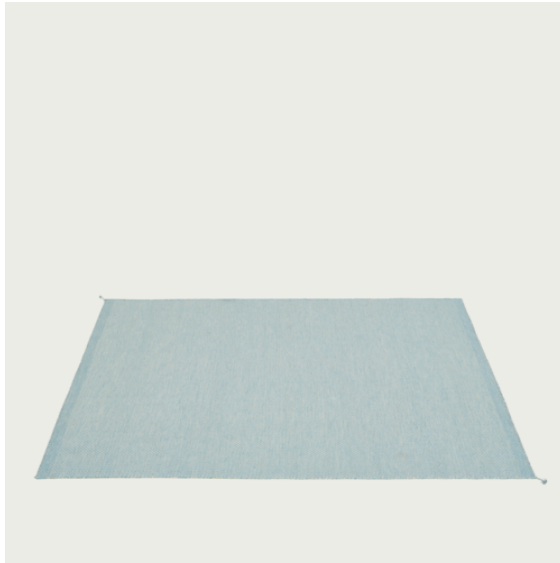

Shipper Colli 1
Gross Weight (kg) 18.2
Net Weight (kg) 16.2
Warranty Period 5 years

Pattern No.	Color	Contract Price	Lead Time
Ready-To-Ship US Warehouse			
MPLYRGRP78116-BLWH	Black/White	USD 1,626.00	-
MPLYRGRP78116-LTBU	Light Blue	USD 1,626.00	-
MPLYRGRP78116-MSGN	Moss Green	USD 1,626.00	-
MPLYRGRP78116-OWHT	Off-White	USD 1,626.00	-

RAISE SERIES

FOR MORE INFORMATION,
EXPLORE BELOW

- ↗ [Product Fact Sheet](#)
- ↗ [Images](#)
- ↗ [Architect Files](#)
- ↗ [Product Declaration](#)

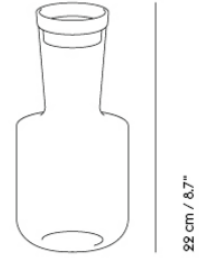

Ø 11 cm / 4.3"
Vol. 1 liter / 33.8 oz

Shipper Colli 1
Gross Weight (kg) 0.85
Net Weight (kg) 0.21
Warranty Period 5 Years

Pattern No.	Color	Contract Price	Lead Time
Ready-To-Ship US Warehouse			
MRSECF-BORG	Burnt Orange	USD 110.00	-
MRSECF-CLR	Clear	USD 110.00	-
MRSECF-DKBU	Dark Blue	USD 110.00	-

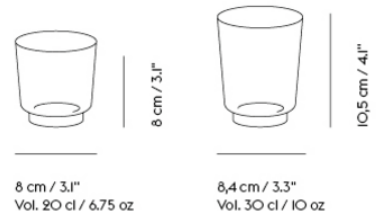
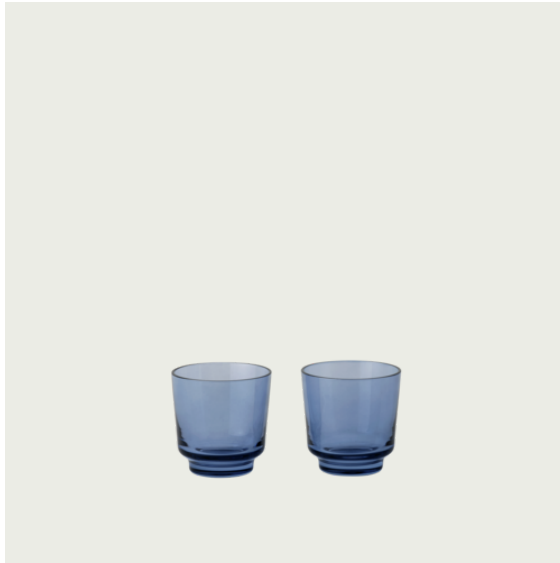

Shipper Colli 1
 Gross Weight (kg) 0.46
 Net Weight (kg) 0.13
 Warranty Period 5 Years

Pattern No.	Color	Contract Price	Lead Time
Ready-To-Ship US Warehouse			
MRSEGL20-BORG	Burnt Orange - 20 cl	USD 58.00	-
MRSEGL20-CLR	Clear - 20 cl	USD 58.00	-
MRSEGL20-DKBU	Dark Blue - 20 cl	USD 58.00	-
MRSEGL30-BORG	Burnt Orange - 30 cl	USD 68.00	-
MRSEGL30-CLR	Clear - 30 cl	USD 68.00	-
MRSEGL30-DKBU	Dark Blue - 30 cl	USD 68.00	-

REDUCE PAPER BIN

FOR MORE INFORMATION,
EXPLORE BELOW

- ↗ [Product Fact Sheet](#)
- ↗ [Images](#)
- ↗ [Architect Files](#)
- ↗ [Product Declaration](#)

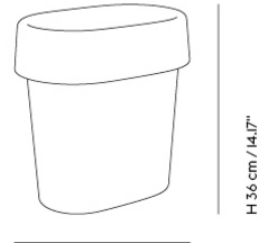

W 25,1 cm / 9.88"
 D 23,6 cm / 9.29"
 Vol. 14 liter / 3.7 gal

Shipper Colli 1
 Gross Weight (kg) 1.7
 Net Weight (kg) 1.36
 Warranty Period 5 years

Pattern No.	Color	Contract Price	Lead Time
Ready-To-Ship US Warehouse			
MRPBN-ANTH	Anthracite	USD 79.00	-
MRPBN-DKRD	Dark Red	USD 79.00	-
MRPBN-GREY	Grey	USD 79.00	-
MRPBN-LTGN	Light Green	USD 79.00	-

RELEVO RUG

FOR MORE INFORMATION,
EXPLORE BELOW

- ↗ [Product Fact Sheet](#)
- ↗ [Images](#)
- ↗ [Assembly Instructions](#)
- ↗ [Product Declaration](#)

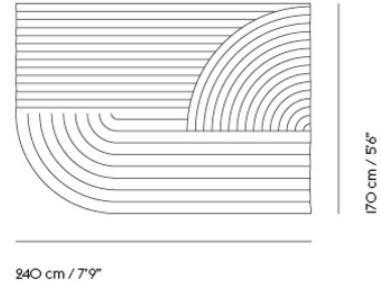

Shipper Colli 1
Gross Weight (kg) 21
Net Weight (kg) 19
Warranty Period 5 Years

Pattern No.	Color	Contract Price	Lead Time
Ready-To-Ship US Warehouse			
MRELVRG6693-BORG	Burnt Orange	USD 1,626.00	-
MRELVRG6693-DKGN	Dark Green	USD 1,626.00	-
MRELVRG6693-LROS	Light Rose	USD 1,626.00	-
MRELVRG6693-OWHT	Off-White	USD 1,626.00	-
MRELVRG6693-SAGN	Sage Green	USD 1,626.00	-
MRELVRG6693-TAUP	Taupe	USD 1,626.00	-

RELEVO RUG / 200 X 300 CM / 6'5" X 9'8"

650

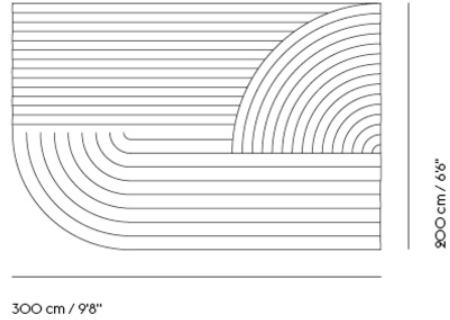
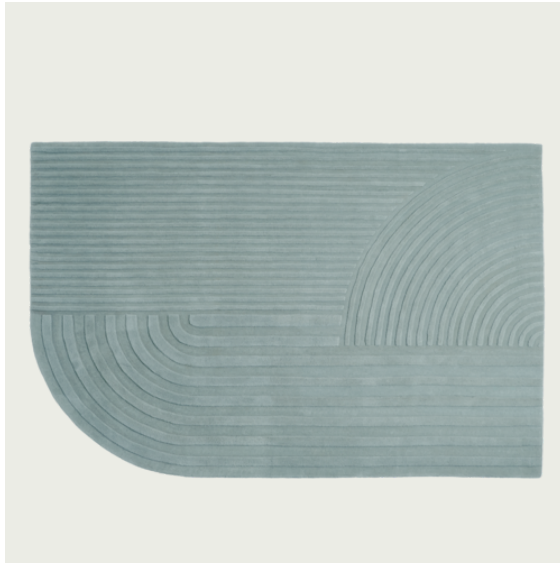

Shipper Colli 1
Gross Weight (kg) 30
Net Weight (kg) 28
Warranty Period 5 Years

Pattern No.	Color	Contract Price	Lead Time
Ready-To-Ship US Warehouse			
MRELVRG78116-BORG	Burnt Orange	USD 2,620.00	-
MRELVRG78116-DKGN	Dark Green	USD 2,620.00	-
MRELVRG78116-LROS	Light Rose	USD 2,620.00	-
MRELVRG78116-OWHT	Off-White	USD 2,620.00	-
MRELVRG78116-SAGN	Sage Green	USD 2,620.00	-
MRELVRG78116-TAUP	Taupe	USD 2,620.00	-

RESTORE SERIES

FOR MORE INFORMATION,
EXPLORE BELOW

- ↗ Product Fact Sheet
- ↗ Images
- ↗ Architect Files
- ↗ Assembly Instructions

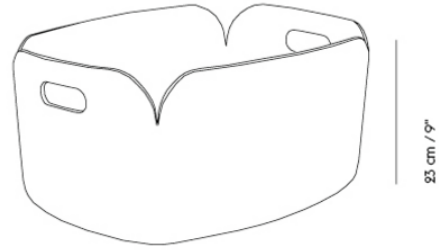

35 x 48 cm / 13.75" x 19"

Shipper Colli 1
Gross Weight (kg) 0.9
Net Weight (kg) 0.8
Warranty Period 5 years

Pattern No.	Color	Contract Price	Lead Time
Ready-To-Ship US Warehouse			
MRESBKR-BEGN	Beige Green	USD 167.00	-
MRESBKR-BLME	Black Mélange	USD 167.00	-
MRESBKR-BRGR	Brown Green	USD 167.00	-
MRESBKR-BORG	Burnt Orange	USD 167.00	-
MRESBKR-DKBW	Dark Brown	USD 167.00	-
MRESBKR-DKGN	Dark Green	USD 167.00	-
MRESBKR-DGRN	Dusty Green	USD 167.00	-
MRESBKR-DLAC	Dusty Lilac	USD 167.00	-
MRESBKR-GREY	Grey Mélange	USD 167.00	-
MRESBKR-LTBU	Light Blue	USD 167.00	-
MRESBKR-MBLU	Midnight Blue	USD 167.00	-
MRESBKR-SAND	Sand	USD 167.00	-

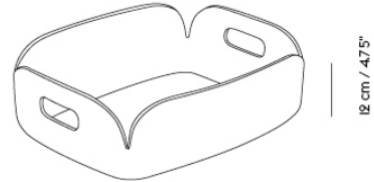

31 x 40 cm / 12.25" x 15.75"

Shipper Colli	1
Gross Weight (kg)	0.55
Net Weight (kg)	0.5
Warranty Period	5 years

Pattern No.	Color	Contract Price	Lead Time
Ready-To-Ship US Warehouse			
MRESTR-BLME	Black Mélange	USD 142.00	-
MRESTR-BRGR	Brown Green	USD 142.00	-
MRESTR-DGRN	Dusty Green	USD 142.00	-
MRESTR-GREY	Grey Mélange	USD 142.00	-
MRESTR-LTBU	Light Blue	USD 142.00	-
MRESTR-MBLU	Midnight Blue	USD 142.00	-
MRESTR-SAND	Sand	USD 142.00	-

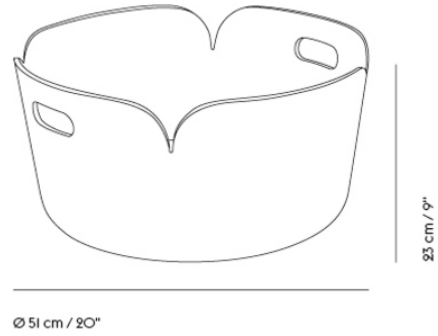

Shipper Colli 1
Gross Weight (kg) 1.2
Net Weight (kg) 1.2
Warranty Period 5 years

Pattern No.	Color	Contract Price	Lead Time
Ready-To-Ship US Warehouse			
MRESBKO-BLME	Black Mélange	USD 184.00	-
MRESBKO-BRGR	Brown Green	USD 184.00	-
MRESBKO-DGRN	Dusty Green	USD 184.00	-
MRESBKO-GREY	Grey Mélange	USD 184.00	-
MRESBKO-MBLU	Midnight Blue	USD 184.00	-

RHYTHM THROW

FOR MORE INFORMATION,
EXPLORE BELOW

[↗ Product Fact Sheet](#)

[↗ Images](#)

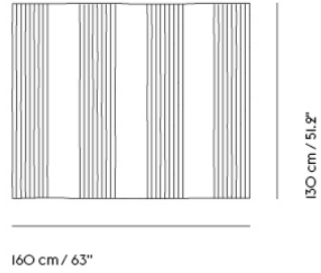

Shipper Colli |
 Net Weight (kg) 0.9
 Warranty Period 5 years

Pattern No.	Color	Contract Price	Lead Time
Ready-To-Ship EU Warehouse			
MRHYTH-DKGN	Dark Green ***	USD 362.00	-

RIDGE SERIES

FOR MORE INFORMATION,
EXPLORE BELOW

- ↗ Product Fact Sheet
- ↗ Images
- ↗ Architect Files

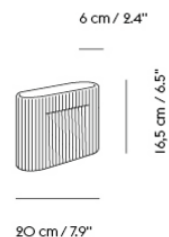
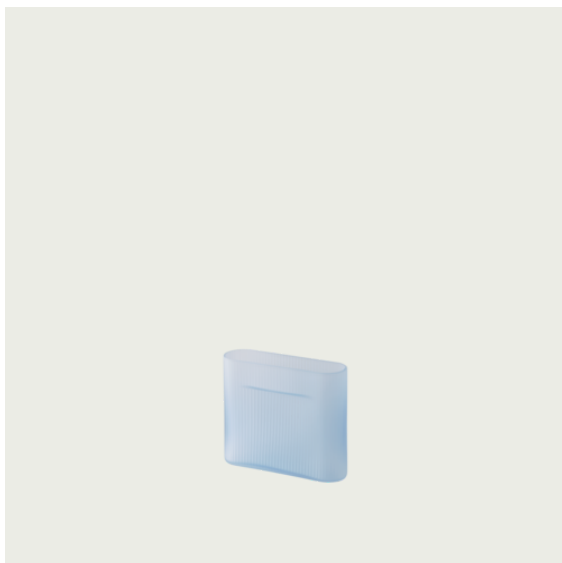

Shipper Colli |
 Gross Weight (kg) |
 Net Weight (kg) 0.75
 Warranty Period 5 years

Pattern No.	Color	Contract Price	Lead Time
Ready-To-Ship US Warehouse			
MRIDVS7-BEIG	Beige	USD 93.00	-
MRIDVS7-OWHT	Off-White	USD 93.00	-
MRIDVS7-TERR	Terracotta	USD 93.00	-
MRIDFVS7-LTBU	Light Blue Frosted Glass	USD 173.00	-
MRIDFVS7-TAUP	Taupe Frosted Glass	USD 173.00	-
MRIDFVS7-WHIT	White Frosted Glass	USD 173.00	-

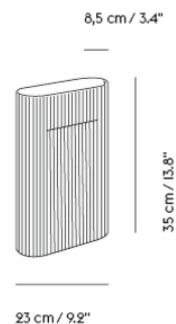

Shipper Colli 1
 Gross Weight (kg) 2.5
 Net Weight (kg) 1.8
 Warranty Period 5 years

Pattern No.	Color	Contract Price	Lead Time
Ready-To-Ship US Warehouse			
MRIDVS14-BEIG	Beige	USD 146.00	-
MRIDVS14-OWHT	Off-White	USD 146.00	-
MRIDVS14-TERR	Terracotta ***	USD 146.00	-
MRIDFVS14-LTBU	Light Blue Frosted Glass	USD 282.00	-
MRIDFVS14-TAUP	Taupe Frosted Glass	USD 282.00	-
MRIDFVS14-WHIT	White Frosted Glass	USD 282.00	-

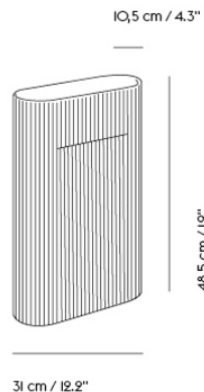

Shipper Colli 1
Gross Weight (kg) 4.8
Net Weight (kg) 4.4
Warranty Period 5 years

Pattern No.	Color	Contract Price	Lead Time
Ready-To-Ship US Warehouse			
MRIDVS19-BEIG	Beige	USD 278.00	-
MRIDVS19-OWHT	Off-White	USD 278.00	-
MRIDVS19-TERR	Terracotta	USD 278.00	-
MRIDFVS19-LTBU	Light Blue Frosted Glass	USD 492.00	-
MRIDFVS19-TAUP	Taupe Frosted Glass	USD 492.00	-
MRIDFVS19-WHIT	White Frosted Glass	USD 492.00	-

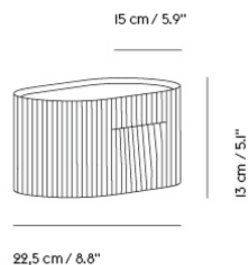

Shipper Colli 1
 Gross Weight (kg) 2.32
 Net Weight (kg) 1.56
 Warranty Period 5 years

Pattern No.	Color	Contract Price	Lead Time
Ready-To-Ship US Warehouse			
MRIDPL5-BEIG	Beige	USD 83.00	-
MRIDPL5-MSGN	Moss Green	USD 83.00	-
MRIDPL5-OWHT	Off-White	USD 83.00	-
MRIDPL5-TAUP	Taupe	USD 83.00	-

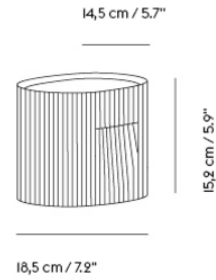

Shipper Colli 1
Gross Weight (kg) 2.175
Net Weight (kg) 1.175
Warranty Period 5 years

Pattern No.	Color	Contract Price	Lead Time
Ready-To-Ship US Warehouse			
MRIDPL6-BEIG	Beige	USD 89.00	-
MRIDPL6-MSGN	Moss Green	USD 89.00	-
MRIDPL6-OWHT	Off-White	USD 89.00	-
MRIDPL6-TAUP	Taupe	USD 89.00	-

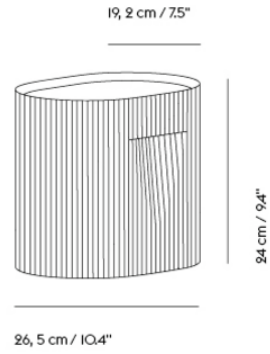

Shipper Colli 1
Gross Weight (kg) 4.8
Net Weight (kg) 2.63
Warranty Period 5 years

Pattern No.	Color	Contract Price	Lead Time
Ready-To-Ship US Warehouse			
MRIDPL9-BEIG	Beige	USD 163.00	-
MRIDPL9-MSGN	Moss Green	USD 163.00	-
MRIDPL9-OWHT	Off-White	USD 163.00	-
MRIDPL9-TAUP	Taupe	USD 163.00	-

SILENT VASE

FOR MORE INFORMATION,
EXPLORE BELOW

- ↗ [Product Fact Sheet](#)
- ↗ [Images](#)
- ↗ [Architect Files](#)
- ↗ [Assembly Instructions](#)

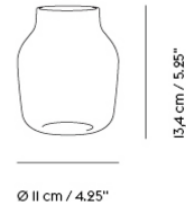
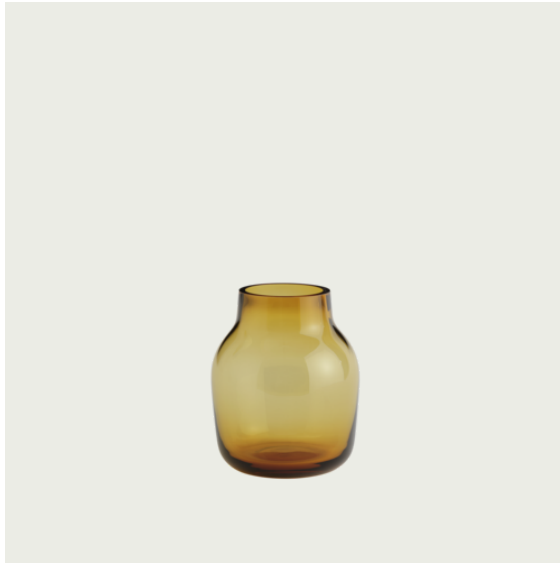

Shipper Colli 1
Gross Weight (kg) 1.6
Net Weight (kg) 1.5
Warranty Period 5 years

Pattern No.	Color	Contract Price	Lead Time
Ready-To-Ship US Warehouse			
MSILVS4-BORG	Burnt Orange	USD 58.00	-
MSILVS4-CLR	Clear	USD 58.00	-
MSILVS4-DKGN	Dark Green	USD 58.00	-

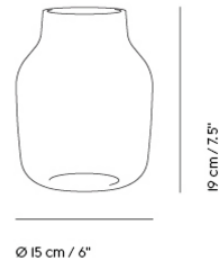

Shipper Colli 1
Gross Weight (kg) 1.85
Net Weight (kg) 1.7
Warranty Period 5 years

Pattern No.	Color	Contract Price	Lead Time
Ready-To-Ship US Warehouse			
MSILVS6-BORG	Burnt Orange	USD 89.00	-
MSILVS6-CLR	Clear	USD 89.00	-
MSILVS6-DKGN	Dark Green	USD 89.00	-

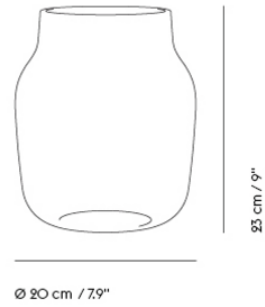

Shipper Colli 1
Gross Weight (kg) 2.4
Net Weight (kg) 2.2
Warranty Period 5 years

Pattern No.	Color	Contract Price	Lead Time
Ready-To-Ship US Warehouse			
MSILVS8-BORG	Burnt Orange	USD 114.00	-
MSILVS8-CLR	Clear	USD 114.00	-
MSILVS8-DKGN	Dark Green	USD 114.00	-

SKETCH TOOLBOX

FOR MORE INFORMATION,
EXPLORE BELOW

- ↗ Product Fact Sheet
- ↗ Images
- ↗ Architect Files
- ↗ Product Declaration

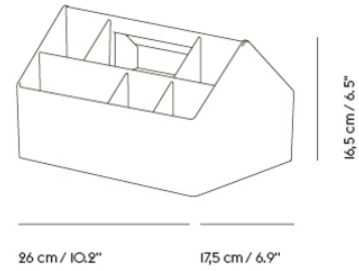

Shipper Colli 1
Gross Weight (kg) 0.95
Net Weight (kg) 0.8
Warranty Period 5 years

Pattern No.	Color	Contract Price	Lead Time
Ready-To-Ship US Warehouse			
MSKTB-BORG	Burnt Orange	USD 68.00	-
MSKTB-GREY	Grey	USD 68.00	-
MSKTB-MBLU	Midnight Blue	USD 68.00	-

STORY PINBOARD

FOR MORE INFORMATION,
EXPLORE BELOW

- ↗ [Product Fact Sheet](#)
- ↗ [Images](#)
- ↗ [Architect Files](#)

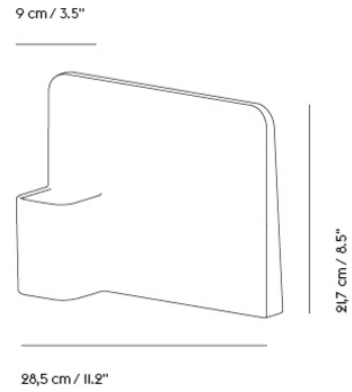

Shipper Colli 1
Gross Weight (kg) 1.15
Net Weight (kg) 0.452
Warranty Period 5 years

Pattern No.	Color	Contract Price	Lead Time
Ready-To-Ship US Warehouse			
MSTPBD	Cork	USD 89.00	-

TUB JUG

FOR MORE INFORMATION,
EXPLORE BELOW

- ↗ [Product Fact Sheet](#)
- ↗ [Images](#)
- ↗ [Architect Files](#)
- ↗ [Product Declaration](#)

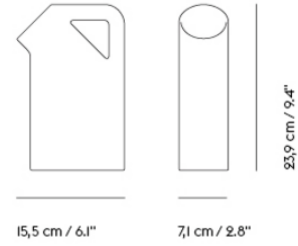

Shipper Colli | 1
Gross Weight (kg) | 1.3
Net Weight (kg) | 1
Warranty Period | 5 years

Pattern No.	Color	Contract Price	Lead Time
Ready-To-Ship US Warehouse			
MTUBJG-DKGN	Dark Green	USD 131.00	-
MTUBJG-PBLU	Pale Blue	USD 131.00	-
MTUBJG-SAND	Sand ***	USD 131.00	-

TWINE CUSHION

FOR MORE INFORMATION,
EXPLORE BELOW

[↗ Product Fact Sheet](#)

[↗ Images](#)

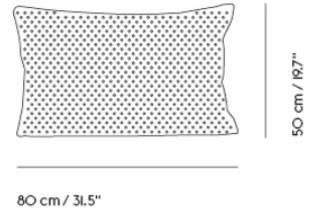

Shipper Colli 1
Gross Weight (kg) 1.2
Net Weight (kg) 0.65
Warranty Period 5 years

Pattern No.	Color	Contract Price	Lead Time
Ready-To-Ship EU Warehouse			
MTWICUS2032-BEGY	Beige-Grey ***	USD 310.00	-

VARJO RUG

FOR MORE INFORMATION,
EXPLORE BELOW

- ↗ [Product Fact Sheet](#)
- ↗ [Images](#)
- ↗ [Architect Files](#)
- ↗ [Assembly Instructions](#)
- ↗ [Product Declaration](#)

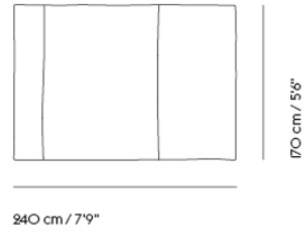

Shipper Colli 1
Gross Weight (kg) 8.8
Net Weight (kg) 7.8
Warranty Period 5 years

Pattern No.	Color	Contract Price	Lead Time
Ready-To-Ship US Warehouse			
MVARRG6693-BLUE	Blue	USD 1,034.00	-
MVARRG6693-DKGN	Dark Green	USD 1,034.00	-
MVARRG6693-DKGY	Dark Grey	USD 1,034.00	-
MVARRG6693-YELW	Yellow	USD 1,034.00	-
Extras			
MPLYPA6681	Rug Pad - 160 x 230 cm / 5'2 x 7'5"	USD 89.00	-

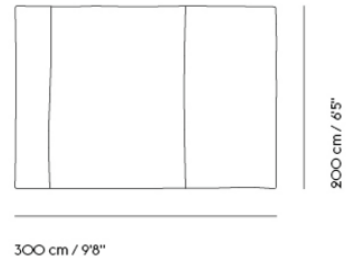

Shipper Colli 1
Gross Weight (kg) 14.7
Net Weight (kg) 12.8
Warranty Period 5 years

Pattern No.	Color	Contract Price	Lead Time
Ready-To-Ship US Warehouse			
MVARRG78116-BLUE	Blue	USD 1,675.00	-
MVARRG78116-DKGN	Dark Green	USD 1,675.00	-
MVARRG78116-DKGY	Dark Grey	USD 1,675.00	-
MVARRG78116-YELW	Yellow	USD 1,675.00	-
Extras			
MPLYPA78116	Rug Pad - 190 x 290 cm / 6'2 x 9'5"	USD 110.00	-

WAVE TRAY

FOR MORE INFORMATION,
EXPLORE BELOW

- ↗ [Product Fact Sheet](#)
- ↗ [Images](#)
- ↗ [Architect Files](#)
- ↗ [Product Declaration](#)

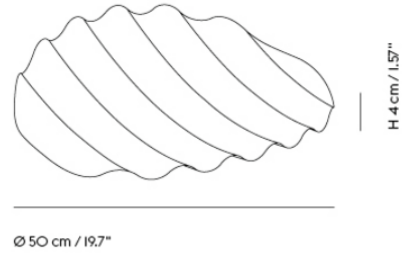

Shipper Colli 1
Gross Weight (kg) 2.8
Net Weight (kg) 2
Warranty Period 5 Years

Pattern No.	Color	Contract Price	Lead Time
Ready-To-Ship US Warehouse			
MWVTY	Steel	USD 278.00	-

PRODUCT

70/70-Grey Frame/Oak (WL) 295x108 cm/116x42,5in
 70/70-Grey Frame/Solid Oak 225x90 cm/85,5x35,5in
 70/70-Grey Frame/Solid Oak 295x108 cm/116x42,5in
 70/70-Grey Frame/Solid Oak 255x108cm/100,5x42,5in
 70/70-Grey Frame/Solid Smoked Oak 225x90 cm
 70/70-Grey Frame/Solid Smoked Oak 295x108 cm
 70/70-Grey Frame/Solid Smoked Oak 255x108cm
 70/70-Sand Frame/Black Lino 225x90 cm/85,5x35,5in

70/70-Sand Frame/Black Lino 255x108cm/100,5x42,5in
 70/70-Sand Frame/Grey Lino 225x90 cm/85,5x35,5in

70/70-Sand Frame/Grey Lino 255x108cm/100,5x42,5in

70/70-Sand Frame/Oak (WL) 225x90 cm/85,5x35,5in
 70/70-Sand Frame/Oak (WL) 295x108 cm/116x42,5in
 70/70-Sand Frame/Solid Oak 225x90 cm/85,5x35,5in
 70/70-Sand Frame/Solid Oak 295x108 cm/116x42,5in
 70/70-Sand Frame/Solid Oak 255x108cm/100,5x42,5in
 70/70-Sand Frame/Solid Smoked Oak 225x90 cm
 70/70-Sand Frame/Solid Smoked Oak 295x108 cm
 70/70-Sand Frame/Solid Smoked Oak 255x108cm
 70/70-Sand Frame/White Lam 255x108cm/100,5x42,5in

70/70-White Frame/Black Lino 225x90 cm/85,5x35,5in
 70/70-White Frame/Black Lino 255x108cm/100,5x42,5in
 70/70-White Frame/Grey Lino 255x108cm/100,5x42,5in
 70/70-White Frame/Oak (WL) 225x90 cm/85,5x35,5in
 70/70-White Frame/Oak (WL) 295x108 cm/116x42,5in
 70/70-White Frame/Solid Oak 225x90 cm/85,5x35,5in
 70/70-White Frame/Solid Oak 295x108 cm/116x42,5in
 70/70-White Frame/Solid Oak 255x108cm/100,5x42,5in
 70/70-White Frame/Solid Smoked Oak 225x90 cm
 70/70-White Frame/Solid Smoked Oak 295x108 cm
 70/70-White Frame/Solid Smoked Oak 255x108cm
 70/70-White Frame/White Lam 255x108cm/100,5x42,5in

Airy coffee table Nano - Half - Frame & top -Black

Airy coffee table Nano - Half - Frame & top -Grey

Airy coffee table Nano - Large - Frame & top -Grey

Airy coffee table Nano - Small - Frame & top -Grey

Airy coffee table Nano - Half-Frame & top-Off-white

Airy coffee table Nano -Large - Frame & top -Black

Airy coffee table Nano -Large-Frame&top -Off-white

Airy coffee table Nano - Medium - Frame & top -Grey

Airy coffee table Nano -Medium-Frame&top-Off-white

Airy coffee table Nano - Small - Frame & top -Black

Airy coffee table Nano -Small-Frame&top-Off-white

Airy coffee table Nano-Medium - Frame & top -Black

Around - Extra Large - Antracit (WL)

Around - Extra Large - Grey (WL)

Around - Extra Large - White (WL)

Around - Large - Antracit (WL)

Around - Large - Black (WL)

Around - Large - Dusty Green (WL)

Around - Large - Grey (WL)

Around - Large - White (WL)

Around - Small - Antracit (WL)

Around - Small - Black (WL)

Around - Small - Dark Green (WL)

Around - Small - Dusty Green (WL)

Around - Small - Grey (WL)

Around - Small - Light Blue (WL)

Around - Small - Tan Rose (WL)

Around - Small - White (WL)

Base high table Black/Black Lino ply 190x85x105

Base high table Black/Black Lino ply 190x50x105

Base high table Black/Black Lino ply 190x50x95

Base high table Black/Black Lino ply 190x85x95

Base high table Black/Oak (WL) 190x50x105

Base high table Black/Oak (WL) 190x50x95

Base high table Black/Oak (WL) 190x85x105

Base high table Black/Oak (WL) 190x85x95

Base high table Black/White Lam ABS 190x50x105

Base high table Black/White Lam ABS 190x50x95

Base high table Black/White Lam ABS 190x85x105

Base high table Black/White Lam ABS 190x85x95

Base high table Black/White Lam ply 190x50x105

Base high table Black/White Lam ply 190x50x95

Base high table Black/White Lam ply 190x85x95

Base high table Black/White Lam ply 190x85x105

Base high table White/Black Lino ply 190x85x105

Base high table White/Black Lino ply 190x50x105

Base high table White/Black Lino ply 190x50x95

Base high table White/Oak (WL) 190x50x105

Base high table White/Oak (WL) 190x50x95

Base high table White/Oak (WL) 190x85x105

Base high table White/Oak (WL) 190x85x95

Base high table White/White Lam ABS 190x50x105

Base high table White/White Lam ABS 190x50x95

Base high table White/White Lam ABS 190x85x105

Base high table White/White Lam ABS 190x85x95

COLOR CODES

TABLE TOP: Oak / FRAME: Grey (RAL 7030)
 TABLE TOP: Oak / FRAME: Grey (RAL 7030)
 TABLE TOP: Oak / FRAME: Grey (RAL 7030)
 TABLE TOP: Oak / FRAME: Grey (RAL 7030)
 TABLE TOP: Smoked Oak / FRAME: Grey (RAL 7030)
 TABLE TOP: Smoked Oak / FRAME: Grey (RAL 7030)
 TABLE TOP: Smoked Oak / FRAME: Grey (RAL 7030)
 TABLE TOP: Black (Forbo 4023) / FRAME: Sand (NCS S 2010-Y30R)

TABLE TOP: Black (forbo 4023 / FRAME: White (RAL 9016)
 TABLE TOP: Grey (Forbo 4175) / FRAME: Sand (NCS S 2010-Y30R)

TABLE TOP: Grey (Forbo 4175) / FRAME: Sand (NCS S 2010-Y30R)

TABLE TOP: Oak FRAME: NCS S 2010-Y30R
 TABLE TOP: Oak FRAME: NCS S 2010-Y30R
 TABLE TOP: Oak FRAME: NCS S 2010-Y30R
 TABLE TOP: Oak FRAME: NCS S 2010-Y30R
 TABLE TOP: Smoked Oak FRAME: NCS S 2010-Y30R
 TABLE TOP: Smoked Oak FRAME: NCS S 2010-Y30R
 TABLE TOP: Smoked Oak FRAME: NCS S 2010-Y30R
 TABLE TOP: White (Fundermax OO85 FH) / FRAME: Sand (NCS S 2010-Y30R)

TABLE TOP: Black (forbo 4023 / FRAME: White (RAL 9016)
 TABLE TOP: Black (forbo 4023 / FRAME: White (RAL 9016)
 TABLE TOP: Grey (Forbo 4175) / FRAME: White (RAL 9016)
 TABLE TOP: Oak / FRAME: White (RAL 9016)
 TABLE TOP: Oak / FRAME: White (RAL 9016)
 TABLE TOP: Oak / FRAME: White (RAL 9016)
 TABLE TOP: Oak / FRAME: White (RAL 9016)
 TABLE TOP: Smoked Oak / FRAME: White (RAL 9016)
 TABLE TOP: Smoked Oak / FRAME: White (RAL 9016)
 TABLE TOP: Smoked Oak / FRAME: White (RAL 9016)
 TABLE TOP: White (Fundermax OO85 SM) / FRAME: White (RAL 9016)

TOP: Black (FENIX NTM Nero Ingo 0720) / FRAME: RAL Classic 9011

TOP: Grey (FENIX NTM Beige Arizona 0748) / FRAME: RAL Classic 7039

TOP: Grey (FENIX NTM Beige Arizona 0748) / FRAME: RAL Classic 7039

TOP: Grey (FENIX NTM Beige Arizona 0748) / FRAME: RAL Classic 7039

TOP: Off White (FENIX NTM Bianco Male 0029) / FRAME: RAL Classic 7044

TOP: Black (FENIX NTM Nero Ingo 0720) / FRAME: RAL Classic 9011

TOP: Off White (FENIX NTM Bianco Male 0029) / FRAME: RAL Classic 7044

TOP: Grey (FENIX NTM Beige Arizona 0748) / FRAME: RAL Classic 7039

TOP: Off White (FENIX NTM Bianco Male 0029) / FRAME: RAL Classic 7044

TOP: Black (FENIX NTM Nero Ingo 0720) / FRAME: RAL Classic 9011

TOP: Off White (FENIX NTM Bianco Male 0029) / FRAME: RAL Classic 7044

TOP: Black (FENIX NTM Nero Ingo 0720) / FRAME: RAL Classic 9011

Antracit (NCS S 8005-R80B)

Grey (Pantone Cool Grey 6C)

White (RAL 9016)

Anthracite (NCS S 8005-R80B)

Black (RAL 9005)

Dusty Green (NCS S 4010-G50Y)

Grey (Pantone Cool Grey 6C)

White (RAL 9016)

Anthracite (NCS S 8005-R80B)

Black (RAL 9005)

RAL 6012

Dusty Green (NCS S 4010-G50Y)

Grey (Pantone Cool Grey 6C)

NCS 1515-B

NCS S 2030-Y80R

White (RAL 9016)

Black (Forbo 4023 / Black (RAL 9005)

Black (Forbo 4023 / Black (RAL 9005)

Black (Forbo 4023 / Black (RAL 9005)

Black (Forbo 4023 / Black (RAL 9005)

RAL Classic 9005

RAL Classic 9005

RAL Classic 9005

RAL Classic 9005

White (Duropal HPL 410) / Black (RAL Classic 9005)

White (Duropal HPL 410) / Black (RAL Classic 9005)

White (Duropal HPL 410) / Black (RAL Classic 9005)

White (Duropal HPL 410) / Black (RAL Classic 9005)

White (Duropal HPL 410) / Black (RAL Classic 9005)

White (Duropal HPL 410) / Black (RAL Classic 9005)

White (Duropal HPL 410) / Black (RAL Classic 9005)

Black (forbo 4023 / White (RAL 9016)

Black (forbo 4023 / White (RAL 9016)

Black (forbo 4023 / White (RAL 9016)

Black (forbo 4023 / White (RAL 9016)

RAL Classic 9016

RAL Classic 9016

RAL Classic 9016

RAL Classic 9016

White (Duropal HPL 410) / White (RAL Classic 9016)

White (Duropal HPL 410) / White (RAL Classic 9016)

White (Duropal HPL 410) / White (RAL Classic 9016)

White (Duropal HPL 410) / White (RAL Classic 9016)

NEAREST MATCH

FRAME: NCS S 4502-Y, Pantone 415 C

FRAME: NCS S 4502-Y, Pantone 415 C

FRAME: NCS S 4502-Y, Pantone 415 C

FRAME: NCS S 4502-Y, Pantone 415 C

FRAME: NCS S 4502-Y, Pantone 415 C

FRAME: NCS S 4502-Y, Pantone 415 C

FRAME: NCS S 4502-Y, Pantone 415 C

FRAME: NCS S 4502-Y, Pantone 415 C

FRAME: NCS S 4502-Y, Pantone 415 C

FRAME: NCS S 4502-Y, Pantone 415 C

FRAME: NCS S 4502-Y, Pantone 415 C

FRAME: NCS S 4502-Y, Pantone 415 C

FRAME: NCS S 4502-Y, Pantone 415 C

FRAME: NCS S 4502-Y, Pantone 415 C

FRAME: NCS S 4502-Y, Pantone 415 C

FRAME: NCS S 4502-Y, Pantone 415 C

FRAME: NCS S 4502-Y, Pantone 415 C

FRAME: NCS S 4502-Y, Pantone 415 C

FRAME: NCS S 4502-Y, Pantone 415 C

FRAME: NCS S 4502-Y, Pantone 415 C

FRAME: NCS S 4502-Y, Pantone 415 C

FRAME: NCS S 4502-Y, Pantone 415 C

FRAME: NCS S 4502-Y, Pantone 415 C

FRAME: NCS S 4502-Y, Pantone 415 C

FRAME: NCS S 4502-Y, Pantone 415 C

FRAME: NCS S 4502-Y, Pantone 415 C

FRAME: NCS S 4502-Y, Pantone 415 C

FRAME: NCS S 4502-Y, Pantone 415 C

FRAME: NCS S 4502-Y, Pantone 415 C

FRAME: NCS S 4502-Y, Pantone 415 C

FRAME: NCS S 4502-Y, Pantone 415 C

FRAME: NCS S 4502-Y, Pantone 415 C

FRAME: NCS S 4502-Y, Pantone 415 C

FRAME: NCS S 4502-Y, Pantone 415 C

FRAME: NCS S 4502-Y, Pantone 415 C

FRAME: NCS S 4502-Y, Pantone 415 C

FRAME: NCS S 4502-Y, Pantone 415 C

FRAME: NCS S 4502-Y, Pantone 415 C

FRAME: NCS S 4502-Y, Pantone 415 C

FRAME: NCS S 4502-Y, Pantone 415 C

FRAME: NCS S 4502-Y, Pantone 415 C

FRAME: NCS S 4502-Y, Pantone 415 C

FRAME: NCS S 4502-Y, Pantone 415 C

FRAME: NCS S 4502-Y, Pantone 415 C

FRAME: NCS S 4502-Y, Pantone 415 C

FRAME: NCS S 4502-Y, Pantone 415 C

FRAME: NCS S 4502-Y, Pantone 415 C

FRAME: NCS S 4502-Y, Pantone 415 C

FRAME: NCS S 4502-Y, Pantone 415 C

FRAME: NCS S 4502-Y, Pantone 415 C

FRAME: NCS S 4502-Y, Pantone 415 C

FRAME: NCS S 4502-Y, Pantone 415 C

FRAME: NCS S 4502-Y, Pantone 415 C

FRAME: NCS S 4502-Y, Pantone 415 C

FRAME: NCS S 4502-Y, Pantone 415 C

FRAME: NCS S 4502-Y, Pantone 415 C

FRAME: NCS S 4502-Y, Pantone 415 C

FRAME: NCS S 4502-Y, Pantone 415 C

FRAME: NCS S 4502-Y, Pantone 415 C

FRAME: NCS S 4502-Y, Pantone 415 C

FRAME: NCS S 4502-Y, Pantone 415 C

FRAME: NCS S 4502-Y, Pantone 415 C

FRAME: NCS S 4502-Y, Pantone 415 C

FRAME: NCS S 4502-Y, Pantone 415 C

FRAME: NCS S 4502-Y, Pantone 415 C

FRAME: NCS S 4502-Y, Pantone 415 C

FRAME: NCS S 4502-Y, Pantone 415 C

FRAME: NCS S 4502-Y, Pantone 415 C

FRAME: NCS S 4502-Y, Pantone 415 C

FRAME: NCS S 4502-Y, Pantone 415 C

FRAME: NCS S 4502-Y, Pantone 415 C

FRAME: NCS S 4502-Y, Pantone 415 C

FRAME: NCS S 4502-Y, Pantone 415 C

FRAME: NCS S 4502-Y, Pantone 415 C

FRAME: NCS S 4502-Y, Pantone 415 C

FRAME: NCS S 4502-Y, Pantone 415 C

PRODUCT

Soft Side Table H48 - Orange/Orange - Ø41
 Soft Side Table H48 - Orange/Orange - Ø48
 Soft Side Table H48cm - B. Green/B. Green - Ø41cm

Soft Side Table H48cm - B. Green/B. Green - Ø48cm

Soft Side Table H48cm - Grey/Grey - Ø41cm
 Soft Side Table H48cm - Grey/Grey - Ø48cm
 Soft Side Table H48cm - Grey/Solid Oak - Ø41
 Soft Side Table H48cm - Grey/Solid Oak - Ø48cm
 Soft Table - B. Green/B. Green Ø95

Soft Table - Black/Black - Ø95

Soft Table - Black/Solid Smoked Oak - Ø95
 Soft Table - Grey/Grey - Ø95
 Soft Table - Grey/Solid Oak - Ø95
 Soft Table H105 - B. Green/B. Green Ø95

Soft Table H105 - Black/Black - Ø95

Soft Table H105 - Black/Solid D.O. Oak Ø95
 Soft Table H105 - Grey/Grey - Ø95
 Soft Table H105 - Grey/Solid Oak - Ø95
 Soft Table H95 - B. Green/B. Green Ø95

Soft Table H95 - Black/Black - Ø95

Soft Table H95 - Black/Solid Smoked Oak Ø95
 Soft Table H95 - Grey/Grey - Ø95
 Soft Table H95 - Grey/Solid Oak - Ø95
 Stacked - Brown Green - Large
 Stacked - Brown Green - Medium
 Stacked - Brown Green - Small
 Stacked - Grey - Large - 2.0
 Stacked - Grey - Medium - 2.0
 Stacked - Grey - Small - 2.0
 Stacked - Insert - Blue Grey
 Stacked - Insert - Grey
 Stacked - Midnight Blue - Small DISC WHEN OOS
 Stacked - Shelf - Brown Green
 Stacked - Shelf - Grey
 Stacked - Shelf - White

Stacked - Top Plate - Brown Green - 1 module
 Stacked - Top Plate - Brown Green - 3 module
 Stacked - Top Plate - Grey - 1 module
 Stacked - Top Plate - Grey - 3 module
 Stacked - Top Plate - White - 1 module
 Stacked - Top Plate - White - 3 module
 Stacked - White - Large - 2.0
 Stacked - White - Medium - 2.0
 Stacked - White - Small - 2.0
 Stacked Bedside Table config. 1 Brown Green
 Stacked Bedside Table config. 1 Grey
 Stacked Bedside Table config. 1 White
 Stacked Bedside Table config. 2 Brown Green
 Stacked Bedside Table config. 2 Grey
 Stacked Bedside Table config. 2 White
 Stacked Bookcase config. 1 Brown Green
 Stacked Bookcase config. 1 Grey
 Stacked Bookcase config. 1 White
 Stacked Bookcase config. 2 Brown Green
 Stacked Bookcase config. 2 Grey
 Stacked Bookcase config. 2 White
 Stacked Bookcase config. 3 Brown Green
 Stacked Bookcase config. 3 Grey
 Stacked Bookcase config. 3 White
 Stacked Bookcase config. 4 Brown Green
 Stacked Bookcase config. 4 Grey
 Stacked Bookcase config. 4 White
 Stacked Bookcase config. 5 Brown Green
 Stacked Bookcase config. 5 Grey
 Stacked Bookcase config. 5 White
 Stacked Bookcase config. 6 Brown Green
 Stacked Bookcase config. 6 Grey
 Stacked Bookcase config. 6 White
 Stacked Bookcase config. 7 Brown Green
 Stacked Bookcase config. 7 Grey
 Stacked Bookcase config. 7 White
 Stacked Bookcase config. 8 Brown Green
 Stacked Bookcase config. 8 Grey

Stacked Bookcase config. 8 White
 Stacked Clip - Brown Green - 2 pcs
 Stacked Clip - Grey - 2 pcs - 2.0
 Stacked Clip - White - 2 pcs - 2.0
 Stacked Hallway Storage config. 1 Brown Green
 Stacked Hallway Storage config. 1 Grey
 Stacked Hallway Storage config. 1 White
 Stacked Hallway Storage config. 2 Brown Green
 Stacked Hallway Storage config. 2 Grey
 Stacked Hallway Storage config. 2 White
 Stacked Hallway Storage config. 3 Brown Green
 Stacked Hallway Storage config. 3 Grey
 Stacked Hallway Storage config. 3 White
 Stacked Hallway Storage config. 4 Brown Green
 Stacked Hallway Storage config. 4 Grey
 Stacked Hallway Storage config. 4 White
 Stacked Office Storage config. 1 Brown Green
 Stacked Office Storage config. 1 Grey
 Stacked Office Storage config. 1 White
 Stacked Office Storage config. 2 Brown Green
 Stacked Office Storage config. 2 Grey
 Stacked Office Storage config. 2 White
 Stacked Office Storage config. 3 Brown Green
 Stacked Office Storage config. 3 Grey

COLOR CODES

TABLE TOP: Formica F32IO Levante BASE: RAL 2000
 TABLE TOP: Formica F32IO Levante BASE: RAL 2000
 TABLE TOP: Formica Laminat F080O Artichoke BASE: NCS S 2020-G8OY
 TABLE TOP: Formica Laminat F080O Artichoke BASE: NCS S 2020-G8OY
 TABLE TOP: Forbo Linoleum 4175 Pebble BASE: RAL 7044
 TABLE TOP: Forbo Linoleum 4175 Pebble BASE: RAL 7044
 TABLE TOP: Oiled Oak BASE: RAL 7044
 TABLE TOP: Oiled Oak BASE: RAL 7044
 TABLE TOP: Formica Laminat F080O Artichoke BASE: NCS S 2020-G8OY
 TABLE TOP: Nanolaminat O72O BASE: RAL 9005

TABLE TOP: Smoked Oak BASE: RAL 9005
 TABLE TOP: Forbo Linoleum 4175 Pebble BASE: RAL 7044
 TABLE TOP: Oiled Oak BASE: RAL 7044
 TABLE TOP: Formica Laminat F080O Artichoke BASE: NCS S 2020-G8OY
 TABLE TOP: Nanolaminat O72O BASE: RAL 9005
 TABLE TOP: Smoked Oak BASE: RAL 9005
 TABLE TOP: Forbo Linoleum 4175 Pebble BASE: RAL 7044
 TABLE TOP: Oiled Oak BASE: RAL 7044
 TABLE TOP: Formica Laminat F080O Artichoke BASE: NCS S 2020-G8OY
 TABLE TOP: Nanolaminat O72O BASE: RAL 9005

TABLE TOP: Smoked Oak BASE: RAL 9005
 TABLE TOP: Forbo Linoleum 4175 Pebble BASE: RAL 7044
 TABLE TOP: Oiled Oak BASE: RAL 7044
 TABLE TOP: Formica Laminat F080O Artichoke BASE: NCS S 2020-G8OY
 TABLE TOP: Nanolaminat O72O BASE: RAL 9005
 TABLE TOP: Smoked Oak BASE: RAL 9005
 TABLE TOP: Forbo Linoleum 4175 Pebble BASE: RAL 7044
 TABLE TOP: Oiled Oak BASE: RAL 7044
 NCS S 6030-G9OY
 NCS S 6030-G9OY
 NCS S 6030-G9OY
 Light Grey (NCS S 2000-N)
 Light Grey (NCS S 2000-N)
 Light Grey (NCS S 2000-N)
 RAL 5008
 RAL 7044
 Midnight Blue (NCS S 80IO-R9OB)

NCS S 6030-G9OY

NCS S 2000-N

RAL 9016

NCS S 6030-G9OY

NCS S 6030-G9OY

NCS S 2000-N

NCS S 2000-N

RAL 9016

RAL 9016

RAL 9016

RAL 9016

RAL 9016

NCS S 6030-G9OY

NCS S 2000-N

RAL 9016

NCS S 6030-G9OY

NCS S 2000-N

RAL 9016

NCS S 6030-G9OY

NCS S 2000-N

RAL 9016

NCS S 6030-G9OY

NCS S 2000-N

RAL 9016

NCS S 6030-G9OY

NCS S 2000-N

RAL 9016

NCS S 6030-G9OY

NCS S 2000-N

RAL 9016

NCS S 6030-G9OY

NCS S 2000-N

RAL 9016

NCS S 6030-G9OY

NCS S 2000-N

RAL 9016

NCS S 6030-G9OY

NCS S 2000-N

RAL 9016

NCS S 6030-G9OY

NCS S 2000-N

RAL 9016

NCS S 6030-G9OY

NCS S 2000-N

RAL 9016

NCS S 6030-G9OY

NCS S 2000-N

RAL 9016

NCS S 6030-G9OY

NCS S 2000-N

RAL 9016

NCS S 6030-G9OY

NCS S 2000-N

RAL 9016

NCS S 6030-G9OY

NCS S 2000-N

RAL 9016

NCS S 6030-G9OY

NCS S 2000-N

RAL 9016

NCS S 6030-G9OY

NCS S 2000-N

RAL 9016

NCS S 6030-G9OY

NCS S 2000-N

NEAREST MATCH

TABLE TOP: NCS S 1070-Y40R
 TABLE TOP: NCS S 1070-Y40R
 TABLE TOP: NCS S 2020-G8OY BASE: Pantone 5855 C

TABLE TOP: NCS S 2020-G8OY BASE: Pantone 5855 C

TABLE TOP: NCS S 3502-Y BASE: NCS S 2502-Y, Pantone 413 C
 TABLE TOP: NCS S 3502-Y BASE: NCS S 2502-Y, Pantone 413 C
 BASE: NCS S 2502-Y, Pantone 413 C
 BASE: NCS S 2502-Y, Pantone 413 C
 TABLE TOP: NCS S 2020-G8OY BASE: Pantone 5855 C

TABLE TOP: NCS S 9000-N BASE: NCS 9000-N, Pantone 419 C

BASE: NCS 9000-N, Pantone 419 C
 TABLE TOP: NCS S 3502-Y BASE: NCS S 2502-Y, Pantone 413 C
 BASE: NCS S 2502-Y, Pantone 413 C
 TABLE TOP: NCS S 2020-G8OY BASE: Pantone 5855 C

TABLE TOP: NCS S 9000-N BASE: NCS 9000-N, Pantone 419 C

BASE: NCS 9000-N, Pantone 419 C
 TABLE TOP: NCS S 3502-Y BASE: NCS S 2502-Y, Pantone 413 C
 BASE: NCS S 2502-Y, Pantone 413 C
 TABLE TOP: NCS S 2020-G8OY BASE: Pantone 5855 C

TABLE TOP: NCS S 9000-N BASE: NCS 9000-N, Pantone 419 C

BASE: NCS 9000-N, Pantone 419 C
 TABLE TOP: NCS S 3502-Y BASE: NCS S 2502-Y, Pantone 413 C
 BASE: NCS S 2502-Y, Pantone 413 C

-

-

-

-

-

-

-

-

-

-

-

-

-

-

-

-

-

-

-

-

-

-

-

-

-

-

-

-

-

-

-

-

-

-

-

-

-

-

-

-

-

-

-

-

-

-

-

-

-

-

-

-

-

-

-

-

-

-

-

-

-

-

-

-

-

-

-

-

-

-

-

-

-

-

-

-

-

-

-

-

-

-

-

-

-

TEXTILE OPTIONS

Striving to work with the best suppliers, the textiles used for Muuto products are by Danish Kvadrat, American KnollTextiles, Swedish Nevotex along with Italian Arve and German Rohleder—all suppliers that have been selected on the basis of their extensive knowledge within the field and state-of-the-art material qualities.

*Upholstered Muuto products that have the Declare Living Building Challenge Compliant certification only have the certification when upholstered with the following Kvadrat textiles: Canvas, Clara, Coda, Divina, Divina MD, Divina Mélange, Fiord, Hallingdal, Remix, Steelcut, Steelcut Trio, Umami and Vidar.

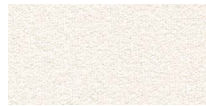

ACCA BY KVADRAT

Designer: Sahco Upholstery.

Composition: 35% viscose, 33% recycled cotton, 25% recycled polyester, 7% recycled polyacrylic.

Durability: 50.000 Martindale / Lightfastness 5-6 (ISO I-8).

Sustainability: Recycled content. Complies with Greenguard Gold Certification.

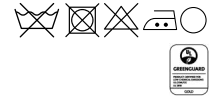

101

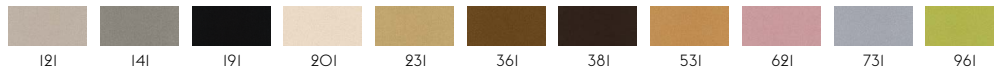

AEGEAN BY KNOLLTEXTILES

Designer: KnollTextiles

Composition: 35% Acrylic, 15% Cotton, 10% Polyester, 40% Viscose

Durability: 60.000 Wyzenbeek Published / Lightfastness 5 (40hrs)

Sustainability: Clean Air - Silver



1

5 colors available for the Outline Series, Connect Modular Series, Echo Pouf and Fiber Series



Additional colors available for Fiber Series

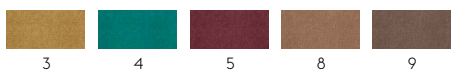

BALDER BY KVADRAT

Designer: Fanny Aronsen

Composition: 68% new wool, 26% cotton, 6% nylon

Durability: 100.000 Martindale / Lightfastness 6

Sustainability: Natural fibres / Sustainable resource. Complies with Greenguard Gold Certification.

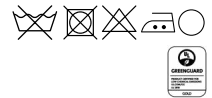

132

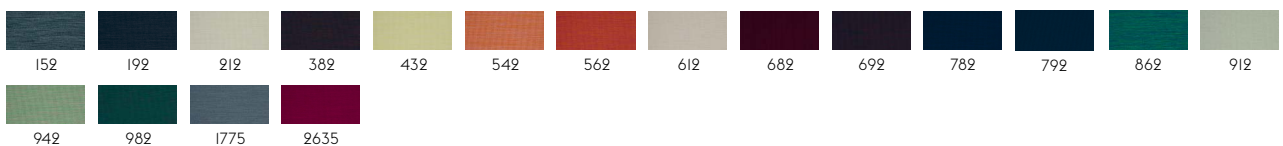

BECK BY MAHARAM

Composition: 78% wool, 22% nylon.

Durability: 100.000 Martindale / Lightfastness AATCC I6.3, 40+ hours.

Sustainability: Complies with Greenguard Gold Certification.

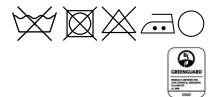

1

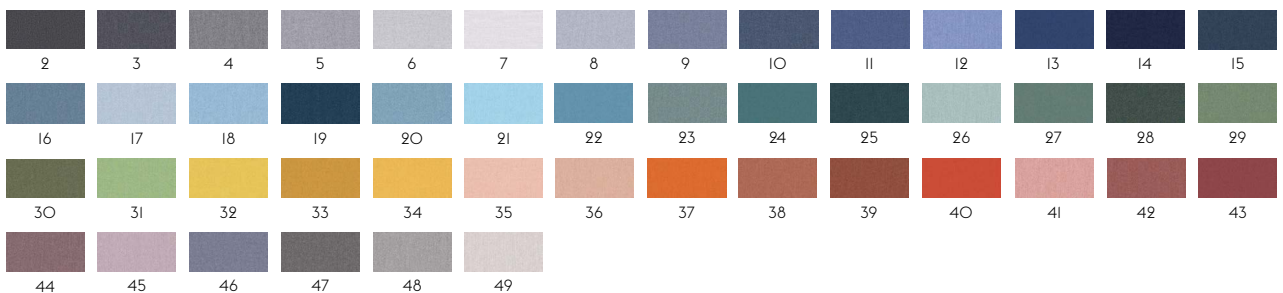



CAMEO BY KNOLLTEXTILES

Designer: KnollTextiles
 Composition: 75% Cotton, 25% Viscose.
 Durability: 30.000 Wyzenbeek Published / Lightfastness 4 (40hrs)
 Sustainability: Greenguard Certification / Clean Air - Silver



CANVAS BY KVADRAT

Designer: Giulio Ridolfo.
 Composition: 90% new wool worsted, 10% nylon.
 Durability: 100.000 Martindale / Lightfastness 5-7 (ISO 1-8).
 Sustainability: Complies with both EU ecolabel "The Flower" and Greenguard Gold Certification.

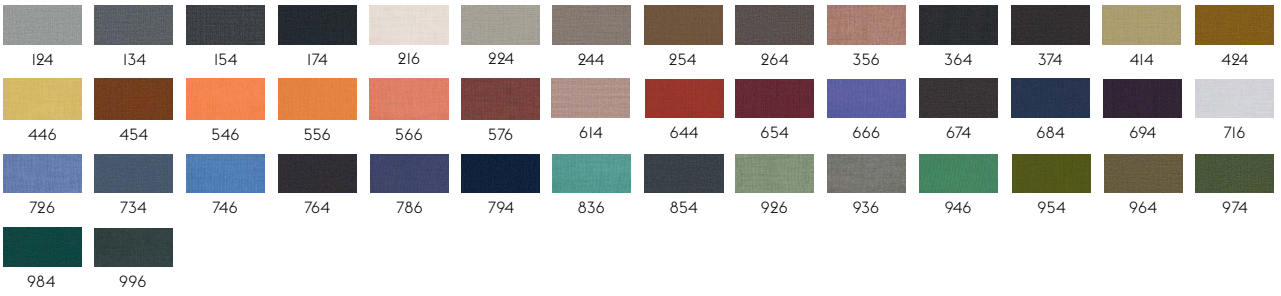
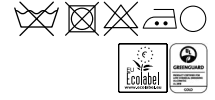

CHAMELEON BY KNOLLTEXTILES

Designer: KnollTextiles
 Composition: 95% Polyurethane, 5% Silicone.
 Durability: 250.000 Wyzenbeek Published
 Sustainability: Clean Air - Gold
 Bleach Cleanable

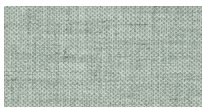
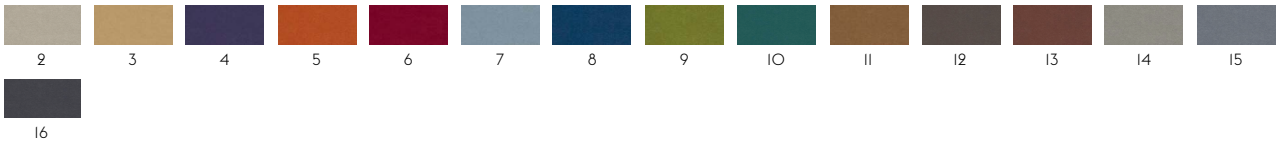

CLARA BY KVADRAT

Designer: Anne Birgitte Hansen.
 Composition: 92% new wool worsted.
 Durability: 80.000 Martindale.
 Sustainability: Complies with both EU ecolabel "The Flower" and Greenguard Gold Certification.

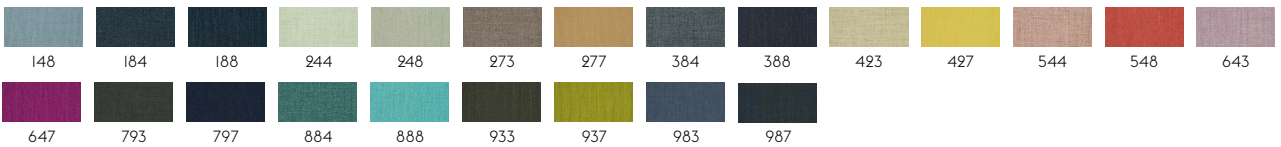
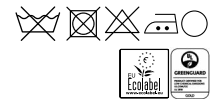

CLAY BY KVADRAT

Designer: Vincent Van Duysen for Kvadrat.
 Composition: 76% Linen, 21% Cotton, 3% Polyester.
 Durability: 45.000 Martindale / Lightfastness 4-6.
 Sustainability: Complies with Greenguard Certification.

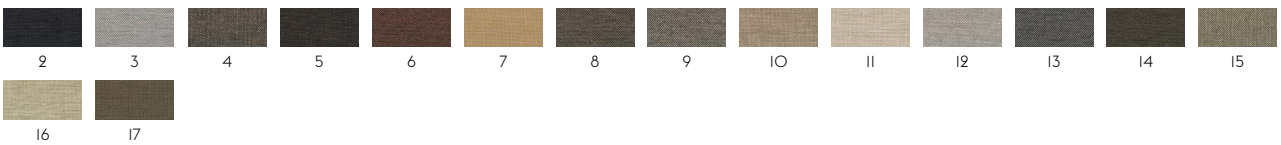



COLOR FIELD BY KNOLLTEXTILES

Designer: KnollTextiles
 Composition: 100% Polyurethane.
 Durability: 250.000 Wyzenbeek Published
 Sustainability: Greenguard Certification / Clean Air - Silver
 Bleach Cleanable

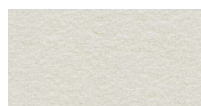

DIVINA BY KVADRAT

Designer: Finn Sködt.
 Composition: 100% new wool.
 Durability: 45.000 Martindale.
 Sustainability: Complies with both EU ecolabel "The Flower" and Greenguard Gold Certification.

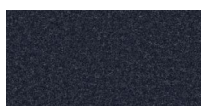
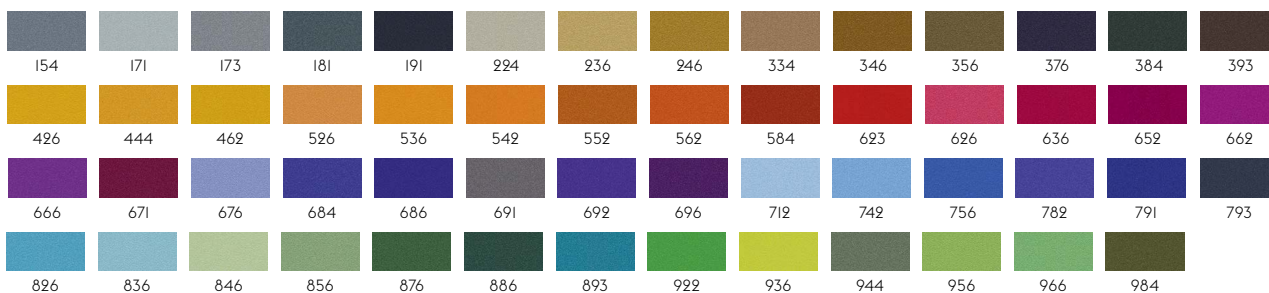

DIVINA MD BY KVADRAT

Designer: Finn Sködt.
 Composition: 100% new wool.
 Durability: 45.000 Martindale.
 Sustainability: Complies with both EU ecolabel "The Flower" and Greenguard Gold Certification.

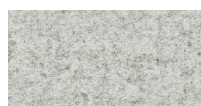
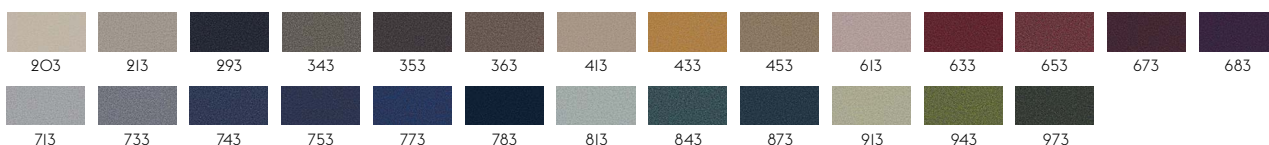

DIVINA MELANGE BY KVADRAT

Designer: Finn Sködt.
 Composition: 100% new wool.
 Durability: 45.000 Martindale / Lightfastness 6-7.
 Sustainability: Complies with both EU ecolabel "The Flower" and Greenguard Gold Certification.

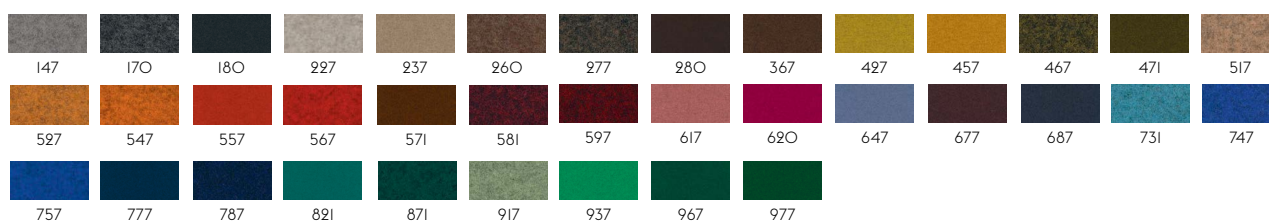

ECRITURE BY KVADRAT

Designer: Sahco.
 Composition: 40% polyacrylic, 27% polyester, 18% viscose, 9% linen, 6% cotton.
 Durability: 70.000 Martindale / Lightfastness 6.
 Sustainability: Complies with Greenguard Gold Certification.

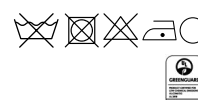

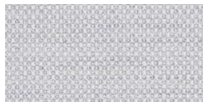

FIORD BY KVADRAT

Designer: Tone Barnung & Louise Sigvardt
 Composition: 92% new wool worsted, 8% nylon.
 Durability: 60.000 Martindale / Lightfastness 5-6.



101

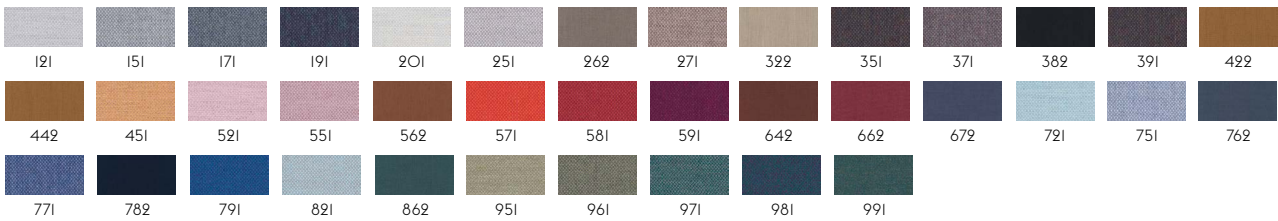

GRAIN BY GABRIEL

Composition: 80% Post-Consumer Recycled Polyester, 20% Polyester
 Durability: 100.000 Martindale / AATCC 16 Light fastness.
 Sustainability: 100% recyclable polyester and meet Möbelfakta requirements



60300

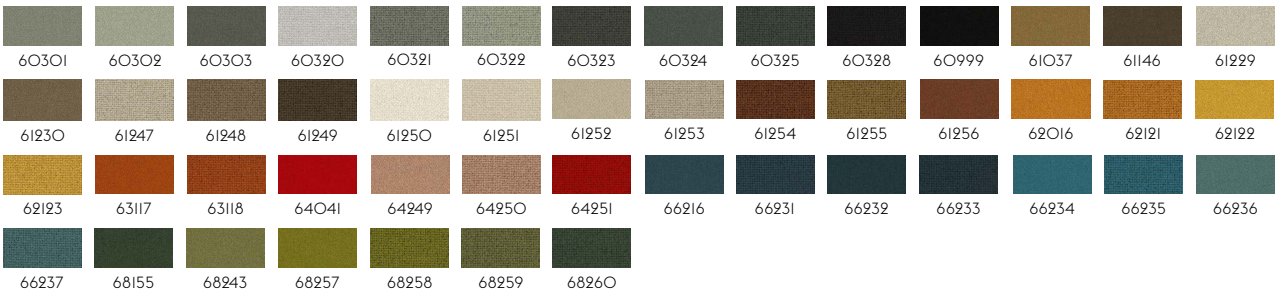

HALLINGDAL 65 BY KVADRAT

Designer: Nanna Ditzel
 Composition: 70% new wool, 30% viscose.
 Durability: 100.000 Martindale / Lightfastness 6-7.
 Sustainability: Complies with both EU ecolabel "The Flower" and Greenguard Gold Certification.



100

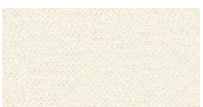
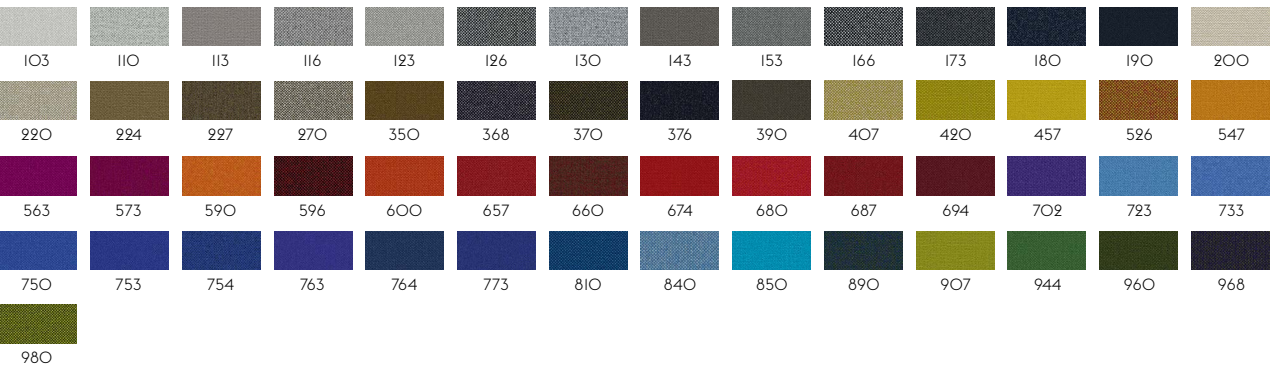

HEARTH BY MAHARAM

Composition: 32% wool, 31% acrylic, 30% cotton, 7% polyester
 Durability: 60.000 Martindale / Lightfastness AATCC 16.3, 40+ hours.
 Sustainability: Complies with Greenguard Gold Certification.



1



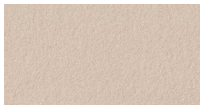

HIGHLAND BY KNOLLTEXTILES

Designer: KnollTextiles
 Composition: 100% Wool
 Durability: 40.000 Martindale 2 / Lightfastness 4 (40hrs 2)
 Sustainability: Greenguard Certification / Clean Air - Silver



KNOLL HOPSACK BY KNOLLTEXTILES

Designer: KnollTextiles
 Composition: 100% Wool
 Durability: 40.000 Martindale / Lightfastness 4 (40hrs).
 Sustainability: Greenguard Certification / Clean Air - Silver.



MANNER BY MAHARAM

Composition: 65% Post-Industrial Recycled Polyester, 35% Post-Consumer Recycled Polyester.
 Durability: 300.000 double rubs Wyzenbeek / Lightfastness AATCC 16.3, 40+ hours.
 Sustainability: Complies with Greenguard Gold Certification.

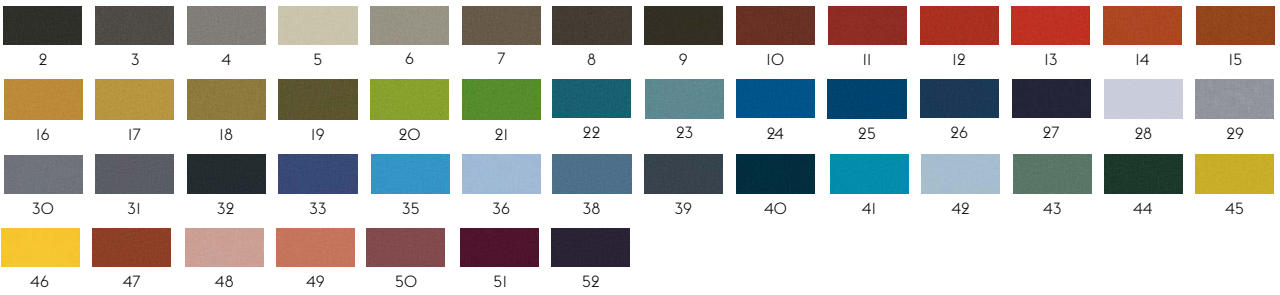
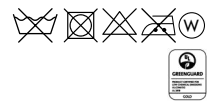

MODERN TWEED BY KNOLLTEXTILES

Designer: KnollTextiles
 Composition: 47% Cotton, 23% Rayon, 14% Polyester, 8% Acrylic, 8% Wool
 Durability: 40.000 Wyzenbeek Published / Lightfastness 4 (40hrs)
 Sustainability: Greenguard Certification / Clean Air - Silver

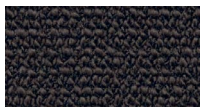

OCEAN BY ROHLEDER

Designer: Rohleder
 Composition: 74 % Polyacrylic / 26 % Polyester
 Durability: 30.000 Martindale / Lightfastness 5-7 (ISO I-8)



PEBBLE WEAVE BY ONE MARIO SIRTORI

Composition: 100% Trevira CS.
 Durability: 45.000 Martindale / Lightfastness 4-5 (ISO I05-B02).





PECORA BY MARIO SIRTORI



6049

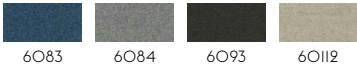

PREMIER SILICONE BY KNOLLTEXTILES

Designer: KnollTextiles
 Composition: 100% SIO Medical Grade Silicone
 Durability: 200.000 Wyzenbeek Published
 Sustainability: Clean Air - Gold
 Bleach Cleanable

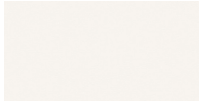

1

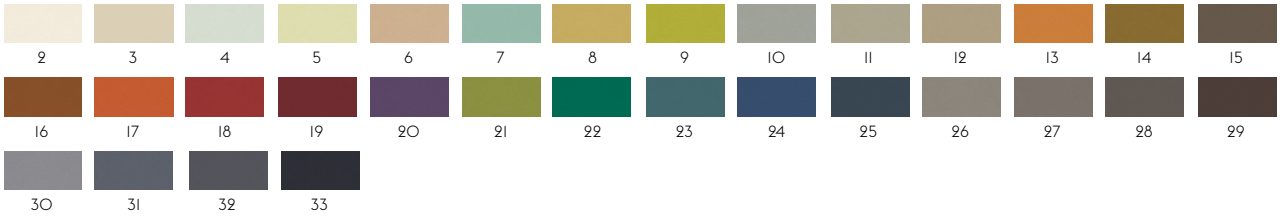

PRAIRIE SILICONE BY KNOLLTEXTILES

Designer: KnollTextiles
 Composition: 100% Non-Phthalate Vinyl
 Durability: 500.000 Wyzenbeek Published / Lightfastness 4 (1000hrs)
 Sustainability: Greenguard Certification / Clean Air - Gold
 Bleach Cleanable

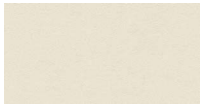

1

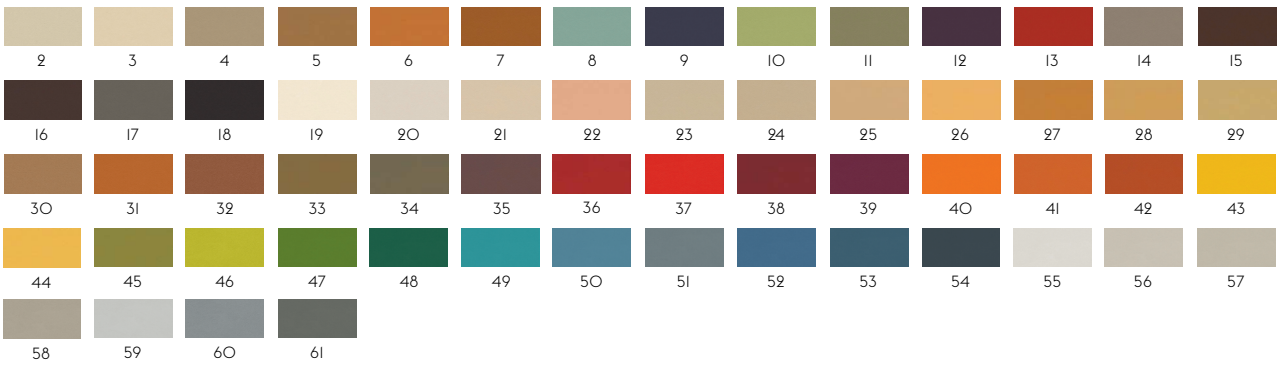

REMIX BY KVADRAT

Designer: Giulio Ridolfo.
 Composition: 90% new wool worsted, 10% nylon.
 Durability: 100.000 Martindale / Lightfastness 5-7 (ISO 1-8)
 Sustainability: Complies with both EU ecolabel "The Flower" and Greenguard Gold Certification.

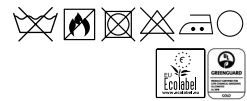

113

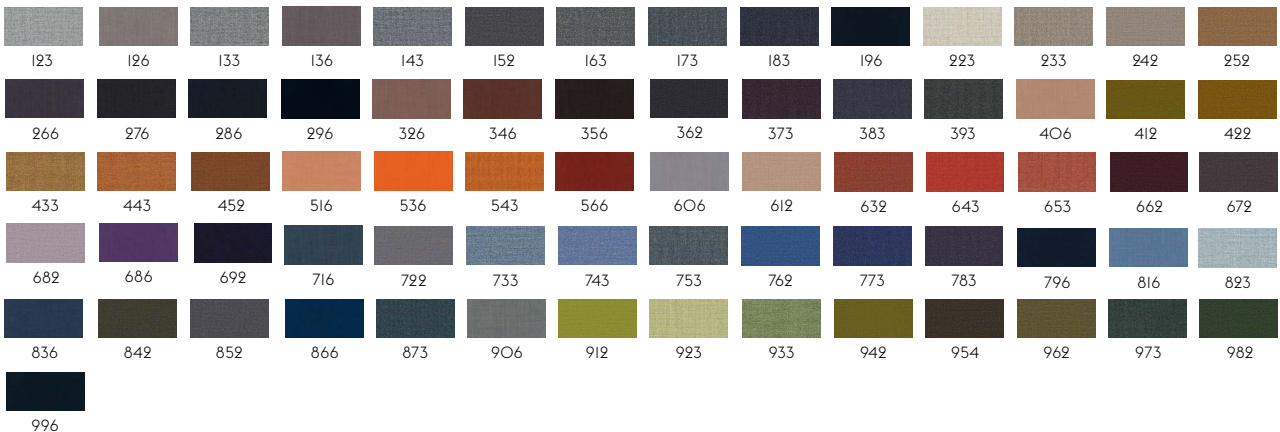



RE-WOOL BY KVADRAT

Designer: Margrethe Odgaard.

Composition: 45% new wool worsted, 45% recycled wool, 10% nylon.

Durability: 100,000 Martindale / Lightfastness 5-7 (ISO 1-8).

Sustainability: Complies with both EU ecolabel "The Flower" and Greenguard Gold Certification.

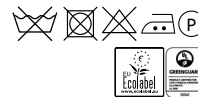

108

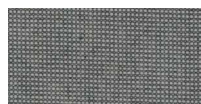
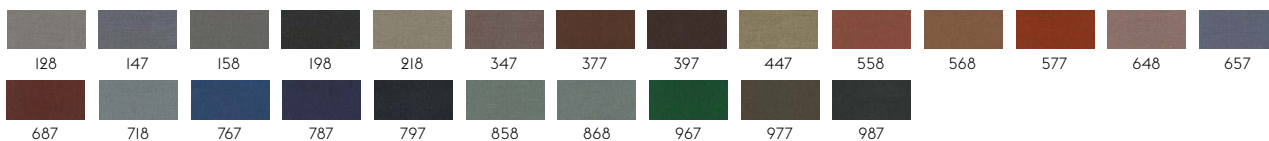

SABI BY KVADRAT

Designer: Louise Sigvardt

Composition: 65% New Wool, Worsted, 23% Recycled Wool, 12% Nylon

Durability: 80,000 Martindale / Lightfastness 5-7

Sustainability: Greenguard Gold, HPD, EPD



121

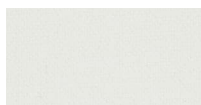
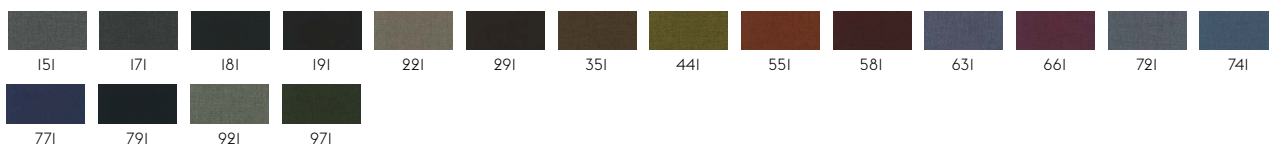

STEELCUT BY KVADRAT

Designer: Dijkmeijer & Ridolfo.

Composition: 90% new wool worsted, 10% nylon.

Durability: 80,000 Martindale / Lightfastness 5-7 (ISO 1-8).

Sustainability: Complies with both EU ecolabel "The Flower" and Greenguard Gold Certification.



110

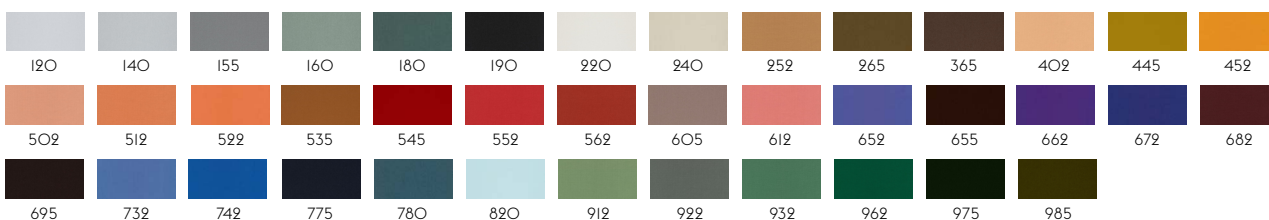

STEELCUT TRIO BY KVADRAT

Designer: Dijkmeijer & Ridolfo

Composition: 90% new wool worsted, 10% nylon.

Durability: 100,000 martindale / Lightfastness 5-7 (ISO 1-8).

Sustainability: Complies with both EU ecolabel "The Flower" and Greenguard Gold Certification.



105

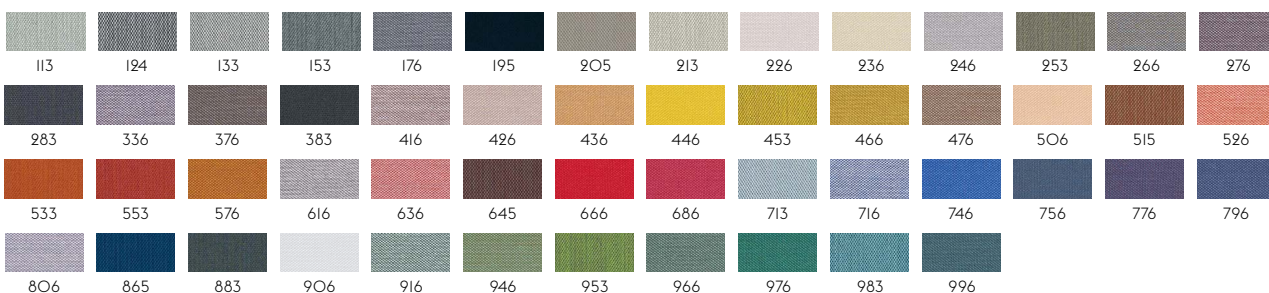



STEELCUT QUARTET BY KVADRAT

Designer: Dijkmeijer & Ridolfo.

Composition: 90% new wool worsted, 10% nylon.

Durability: 100.000 Martindale / Lightfastness 6-7 (ISO 105-B02).

Sustainability: Complies with both EU ecolabel "The Flower" and Greenguard Gold Certification.



114

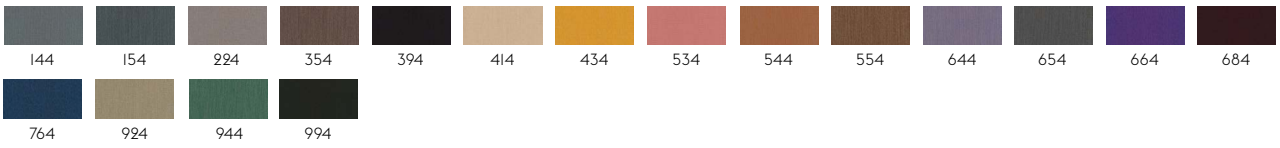

STRETCH APPEAL BY KNOLLTEXTILES

Designer: KnollTextiles

Composition: 78% Wool, 20% Mohair, 2% PU (Elasthan).

Durability: 100.000 Wyzenbeek / Lightfastness 4 (40hrs).

Sustainability: Greenguard Certification / Clean Air - Silver.

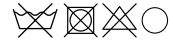

2

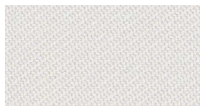

TWILL WEAVE BY KVADRAT

Designer: Jonathan Olivares

Composition: 90% new wool (worsted), 10% nylon

Durability: 60.000 Martindale

Sustainability: Complies with both EU ecolabel "The Flower" and Greenguard Gold Certification.

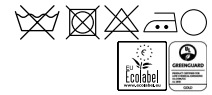

110

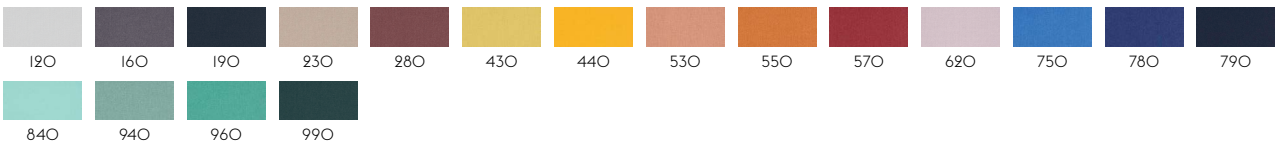

VANCOUVER BY ROSSINI DELLA QUERCIA

Designer: Gabriella Zecca

Composition: 52% cotton, 48% acrylic.

Durability: 40.000 Martindale / Lightfastness 4-5.

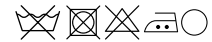

4



VIBE II BY KNOLLTEXTILES

Designer: KnollTextiles

Composition: 100% Polyurethane

Durability: 100.000 Wyzenbeek Published / Lightfastness 5 (200hrs)

Sustainability: Clean Air - Gold

Bleach Cleanable

1

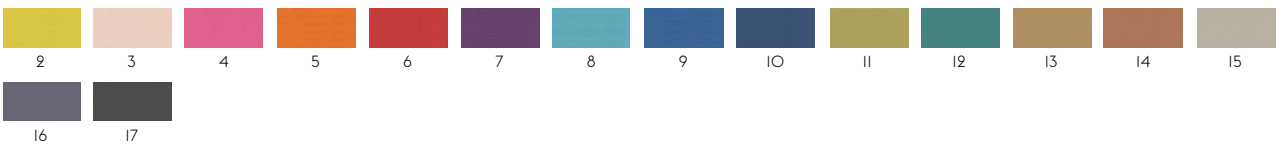



VIDAR BY KVADRAT

Designer: Raf Simons & Fanny Aronsen for Kvadrat.

Composition: 94% new wool, 6% nylon.

Durability: 100.000 Martindale / Lightfastness 6-7.

Sustainability: Natural fibres / Sustainable resource. Complies with Greenguard Gold Certification.

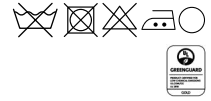

106

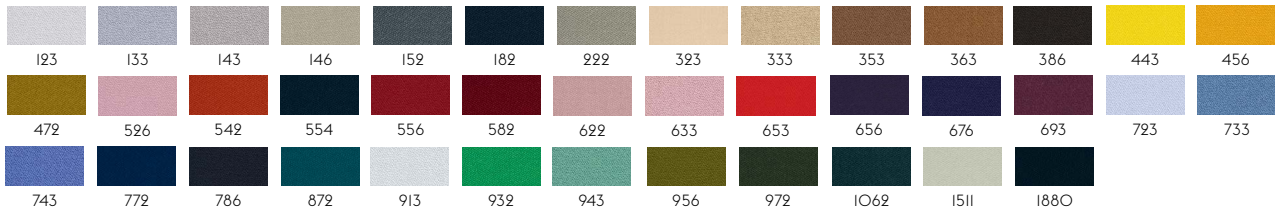

WOOLY BY NEVOTEX

Designer: Nevotex

Composition: 70% wool, 25% polyamide, 5% other fibres.

Durability: 150.000 Martindale / Lightfastness 6-8.



0091

Wooly is woven in 70% recycled wool, sourced from leftover materials of clothing production and other wool products. One kilo of pure new wool generates 9 kilograms of carbon dioxide when produced while processing one kilo of recycled wool only generates 0.5 kilograms of carbon dioxide. Furthermore, recycled wool has a positive environmental impact due to lessened water consumption and lower energy consumption.

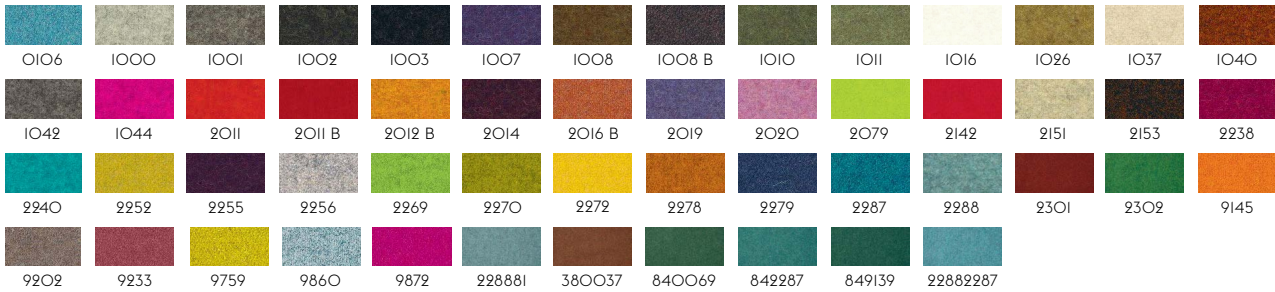

LEATHER OPTIONS

At Muuto, we work with some of the leading leather suppliers to ensure that the leather used for our designs is always of the highest possible standard. Our leather options range from the Refine Leather, a modern and sleek full-grain leather with a soft touch, over Easy Leather, a lightly buffed natural grain leather with a soft and waxy feel along with a matte look, to our Endure Leather, a pliable and extremely durable semi-aniline leather ideal for hard contract environments, and the Volo Leather from Spinneybeck, a chromium-tanned, aniline-dyed leather that has been specially retanned for an enriched and soft feel.



CHAL

ALLURE LEATHER

Soft nubuck aniline leather from European raw hides, known for its exclusive appeal and soft, velvety feel. The leather is dyed through, chrome tanned and produced without the use of PCP and CFC which can be damaging to the environment.



ZINC

EASY LEATHER

Lightly Buffed Natural Grain Leather
Raw material: Designed and processed in Italy. The leather is dyed through, chrome tanned and finishing is with resins and pigments.

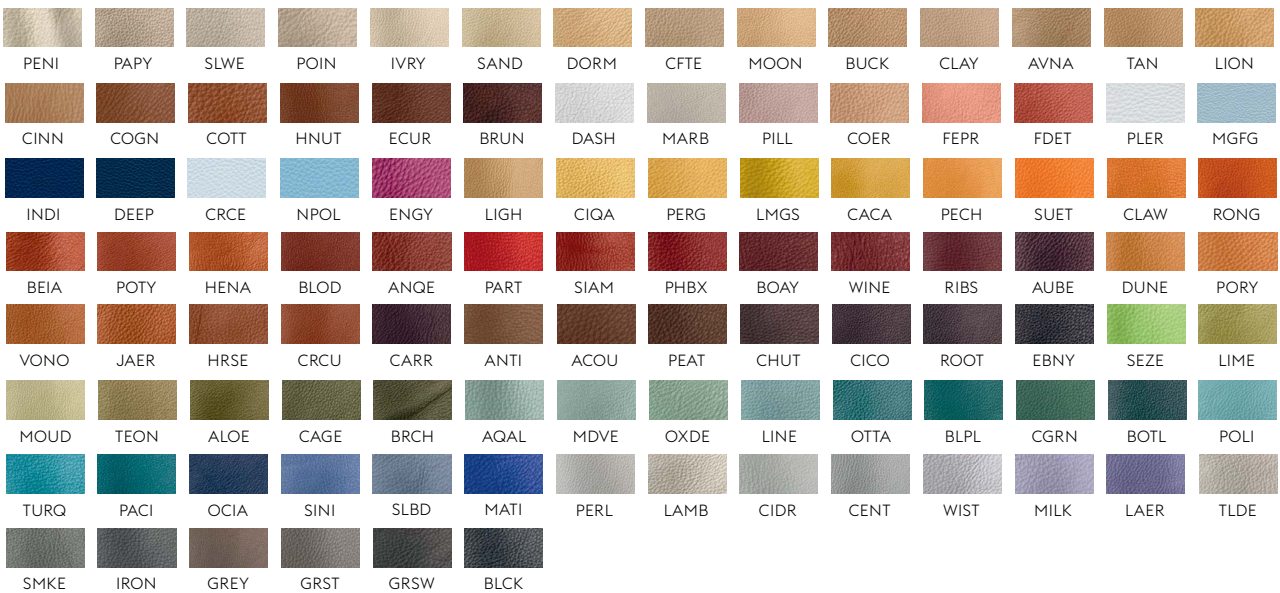

CWIT

ENDURE LEATHER

Semi-aniline leather with high durability, making it ideal for contract environments.
Raw material: Leather from Scandinavian raw hides.
The leather is dyed through a chrome free tanning process. Also available in custom colors in a minimum of 1 hide.





ANTH

GRACE LEATHER

Aniline leather from European raw hides with a natural look and velvety feel, characterized by the natural markings and imperfections that give it a distinct beauty. The leather is dyed through, tanned without chrome and produced without the use of PCP and CFC which can be damaging to the environment.



GREY

RGRN

DKBW

RUST

CAML

COGN

ECRU

ALND

STON



CREM

REFINE LEATHER

Aniline Leather.

Raw material: Grain leather from European raw hides. The leather is dyed through, chrome tanned and produced without the use of PCP and CFC which can be damaging to the environment.

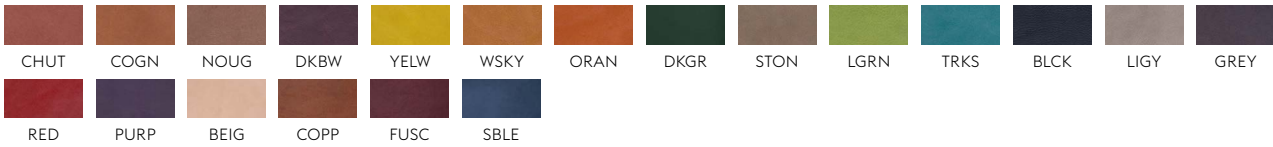

CHUT

COGN

NOUG

DKBW

YELW

WSKY

ORAN

DKGR

STON

LGRN

TRKS

BLCK

LIGY

GREY

RED

PURP

BEIG

COPP

FUSC

SBLE