

# CONTRACT PRICE LIST

# SEPTEMBER 2024



# INTRODUCTION TO THE MUUTO PRICELIST

The Muuto Price List is a complete and comprehensive tool that contains all relevant information to formulate an order. On this page, you will find important product and order information. Please contact Muuto Customer Care or your Muuto Sales Manager if you need further information.

## Prices

Recommended retail prices include VAT.  
Wholesale prices are stated excl. VAT.  
Prices are valid from 09.13.2024.  
All prices are subject to change.

## Warranty

According to Muuto's general terms of sale and delivery:  
10 years on all BIFMA-tested products.  
5 years on all other products.

Any alteration or modification to the products (incl. certification through 3rd party) are not covered by the warranty.

## Discontinued Products

Products marked with \*\*\* will be discontinued when out of stock.

## Customers Own Material (COM) & Customers Own Leather (COL)

Price includes the cost to upholster the product using the customer's own material. The cost of the material is not included in the price. All COM/COL requests are subject to testing and approval. Lead times stated in the price list are based on when the factory receives the material.

## Test Samples

Muuto offers sourcing of non-standard textiles for upholstered products. Muuto will provide pricing on products in nonstandard textile and confirm if a textile is subject to test upholstery. Prices for test sample products are stated in the pricelist under each product. If textile is provided to Muuto, Muuto will invoice COM price as defined in the price list and potentially the price for the test upholstery. Lead-time of production is confirmed by Muuto after test approval. Confirmed lead times are from reception of textile.

## MOQ

Minimum Order Quantity.

## MOQ Fee

A MOQ fee is applied when the stated MOQ is not met.

## Start Up Fee

The cost to produce a product in a special color and/or non standard size.

## Ready-To-Ship

Indicates products that are ready to be shipped from the Muuto warehouse.

## Lead Times

Lead times are stated excluding transport from a Muuto warehouse.

## Colli

Colli indicates the number of items per item number.

## Shipper Colli

Shipper Colli indicates the number of boxes shipped per item.

## Test, Labels & Certificates

Our supply chain is constantly evolving; please confirm conformance to the attributes of the given test at the time of specifying your order as information is subject to change.

## Contact Information

[www.muuto.com/contact](http://www.muuto.com/contact)



Explore our new perspectives on Scandinavian design across furniture, lighting and accessories. Each design within our collection has its own family page with designer quote, product description, material information, cleaning instructions and more, followed by the pricing options for each individual variant.

<b>INTRODUCTION TO THE PRICE LIST</b> _____	<b>1</b>	Doze Lounge Chair Low Back Tube Base _____	Fiber Lounge Chair Seat Pad _____	154
<b>INDEX</b> _____	<b>2</b>	Doze Ottoman Tube Base _____	Made-To-Order: Fiber Lounge _____	155
		Doze Lounge Chair High Back Swivel Base _____	<b>Fiber Soft Series</b> _____	<b>157</b>
		Doze Lounge Chair Low Back Swivel Base _____	Fiber Soft Armchair Wood Base _____	158
<b>FURNITURE</b>		Doze Ottoman Swivel Base _____	Fiber Soft Armchair Tube Base _____	159
<b>70/70 Table</b> _____	<b>6</b>	Made-To-Order Options _____	Fiber Soft Armchair Swivel Base _____	160
70/70 Table _____	7	<b>Earnest Table</b> _____	Made-To-Order Options: Fiber Soft Armchair _____	161
Made-To-Order Options _____	15	_____	<b>Fiber Conference Series</b> _____	<b>164</b>
<b>70/70 Outdoor</b> _____	<b>16</b>	<b>Echo Pouf</b> _____	Fiber Conference Armchair Wood Base _____	165
<b>Airy Coffee Table</b> _____	<b>18</b>	Echo Pouf _____	Fiber Conference Armchair Swivel Base _____	166
<b>Around Coffee Table</b> _____	<b>23</b>	Made-To-Order Options _____	Fiber Conference Armchair Swivel Base w. Gas Lift, Castors and Tilt _____	167
<b>Base Table Series</b> _____	<b>27</b>	<b>Enfold Sideboard</b> _____	Made-To-Order Options _____	168
Base Table _____	28	<b>Fiber Chair Series</b> _____	<b>Fiber Outdoor Series</b> _____	<b>171</b>
Base Round Table _____	31	Fiber Armchair Wood Base _____	Fiber Outdoor Armchair _____	172
Base High Table _____	32	Fiber Armchair Tube Base _____	Fiber Outdoor Side Chair _____	173
Cable Management Solution _____	36	Fiber Armchair Swivel Base _____	<b>Five Pouf</b> _____	<b>174</b>
Made-To-Order Options _____	37	Fiber Armchair Swivel Base w. Gas Lift and Castors _____	Five Pouf _____	175
<b>Compile Shelving System</b> _____	<b>41</b>	Fiber Side Chair Wood Base _____	Made-To-Order Options _____	177
Compile Shelving System Configurations _____		Fiber Side Chair Tube Base _____	<b>Flow Series</b> _____	<b>178</b>
Compile Shelving System Shelf _____	50	Fiber Side Chair Swivel Base _____	<b>In Situ Modular Sofa</b> _____	<b>181</b>
Compile Shelving System Essential Pack _____	51	Fiber Side Chair A-Base _____	In Situ Modular Sofa 2-Seater Configurations _____	184
Compile Shelving System Divider Pack _____	51	Fiber Chair Seat Pad _____	In Situ Modular Sofa 3-Seater Configurations _____	191
<b>Connect Modular Sofa</b> _____	<b>53</b>	Made-To-Order: Fiber Armchair wood, tube, sled base _____	In Situ Modular Sofa 4-Seater Configurations _____	200
Connect Modular Sofa _____	56	Made-To-Order: Fiber Armchair Swivel, Swivel w/castors & Gaslift _____	In Situ Modular Sofa Corner Configurations _____	205
Made-To-Order Options _____	63	Made-To-Order: Fiber Side Chair wood, tube, sled base _____	In Situ Modular Sofa Modules _____	214
<b>Connect Soft Modular Sofa</b> _____	<b>64</b>	Made-To-Order: Fiber Side Chair Swivel, Swivel w/castors & Gaslift _____	In Situ Modular Sofa Cushion _____	223
Connect Soft Modular Sofa Modules _____	67	Made-To-Order: Fiber Side Chair A-base _____	In Situ Modular Sofa Frame Section _____	225
Connect Soft Modular Sofa 2-Seater Configurations _____	76	<b>Fiber Bar &amp; Counter Series</b> _____	In Situ Modular Sofa Linking Bracket _____	235
Connect Soft Modular Sofa 3-Seater Configurations _____	79	Fiber Counter Stool Wood Base - 65 cm / 25.6" _____	In Situ Modular Sofa Frame Configuration _____	236
Connect Soft Modular Sofa Corner Configurations _____	82	Fiber Bar Stool Wood Base - 75 cm / 29.5" _____	Made-To-Order Options - Individual parts _____	240
Connect Soft Modular Sofa Cushion _____	85	Fiber Counter Stool Tube Base - 65 cm / 25.6" _____	<b>Linear Steel Series</b> _____	<b>241</b>
Made-To-Order Options _____	86	Fiber Bar Stool Tube Base - 75 cm / 29.5" _____	Linear Steel Table _____	242
<b>Couple Coffee Table</b> _____	<b>87</b>	Made-To-Order: Fiber Stools _____	Linear Steel Bench _____	245
<b>Cover Chair Series</b> _____	<b>93</b>	<b>Fiber Lounge Series</b> _____	Linear Steel Side Chair _____	247
Cover Armchair _____	94	Fiber Lounge Armchair Wood Base _____	Linear Steel Armchair _____	248
Cover Side Chair _____	95	Fiber Lounge Armchair Tube Base _____	Linear Steel Café Table _____	249
Cover and Visu Chair Transport Trolley _____	96	Fiber Lounge Chair Wood Base _____	Linear Steel Bar Stool 75 cm / 29.5" _____	255
Cover Lounge Chair _____	97	Fiber Lounge Chair Tube Base _____	Linear Steel Counter Stool 65 cm / 25.6" _____	
Cover Bar Stool 75 cm / 29.5" _____	98			
Cover Counter Stool 65 cm / 25.6" _____	99			
Made-To-Order Options _____	100			
<b>Doze Lounge Chair &amp; Ottoman</b> _____	<b>102</b>			
Doze Lounge Chair High Back Tube Base _____	103			

Linear Steel Lounge Armchair	257	256	<b>Power Outlet</b>	<b>385</b>	<b>Beam Table Lamp</b>	<b>507</b>
Linear Steel Coffee Table	258	<b>Reflect Sidebord</b>	<b>387</b>	<b>Control Table Lamp</b>	<b>509</b>	
<b>Linear System Series</b>	<b>260</b>	<b>Relate Side Table</b>	<b>390</b>	<b>Dedicate Lamp Series</b>	<b>511</b>	
Linear System Table	273	<b>Rest Sofa Series</b>	<b>393</b>	Dedicate Table Lamp	512	
Linear System High Table	279	Rest Sofa 3-Seater	394	Dedicate Wall Lamp	521	
Linear System Middle Module	285	Made-To-Order Options	395	<b>E27 Pendant Lamp</b>	<b>524</b>	
Linear System End Module	288	<b>Soft Table Series</b>	<b>396</b>	<b>Fluid Pendant Lamp</b>	<b>527</b>	
Linear System Connecting Legs	296	Soft Side Table	397	<b>Grain Pendant Lamp</b>	<b>530</b>	
Linear System Tray	299	Soft Coffee Table	403	<b>Leaf Lamp Series</b>	<b>532</b>	
Linear System Screen	303	Soft Café Table	406	Leaf Table Lamp	533	
Linear Table Lamp	306	Soft Table	412	Leaf Floor Lamp	534	
Linear Mounted Lamp	307	<b>Stacked Storage System</b>	<b>415</b>	<b>Linear Lamp Series</b>	<b>535</b>	
Linear Pendant Lamp	309	Stacked Storage System Open Modules	419	Linear Table Lamp	536	
Linear System Power Configuration	311	Stacked Storage System Modules w.	419	Linear Pendant Lamp	537	
Linear System Cable Tray	312	Backboard	422	Linear Mounted Lamp	539	
Linear System Table Power Outlet	313	Stacked Storage System Modules w.	425	<b>Post Lamp Series</b>	<b>541</b>	
Made-To-Order Options: Linear System	314	Door	425	Post Wall Lamp	542	
Screens	314	Stacked Storage System Plinth	427	Post Floor Lamp	543	
<b>Linear Wood Series</b>	<b>315</b>	Stacked Storage System Podium w. Tube	429	Post Table Lamp	544	
Linear Wood Table	316	Base	429	<b>Pull Floor Lamp</b>	<b>545</b>	
Linear Wood Bench	319	Stacked Storage System Insert	431	<b>Rime Lamp Series</b>	<b>547</b>	
<b>Loft Chair Series</b>	<b>321</b>	Stacked Storage System Shelf	432	<b>Set Table Lamp</b>	<b>551</b>	
Loft Chair	322	Stacked Storage System Top Plate	433	<b>Strand Lamp Series</b>	<b>553</b>	
Loft Chair W. Armrest	323	Stacked Storage System Clips	435	Strand Pendant Lamp	554	
Loft Counter Stool 65 cm / 25.6"	324	Stacked Storage System Acoustic Panel	435	Strand Table Lamp	560	
Loft Bar Stool 75 cm / 29.5"	325	Stacked Storage System Seat	437	<b>Tip Lamp Series</b>	<b>561</b>	
Made-To-Order Options	326	Cushion	440	Tip Table Lamp	562	
<b>Midst Table</b>	<b>327</b>	Stacked Storage System Bedside Table	441	Tip Wall Lamp	563	
<b>Mini Stacked Storage System</b>	<b>330</b>	Stacked Storage System Bookcase	441	<b>Under The Bell Pendant Lamp</b>	<b>564</b>	
<b>Nerd Chair Series</b>	<b>336</b>	Stacked Storage System Hallway	443	<b>Unfold Pendant Lamp</b>	<b>567</b>	
Nerd Chair	337	Storage	451			
Nerd Counter Stool 65 cm / 25.6"	338	Stacked Storage System Office Storage	455			
Nerd Bar stool 75 cm / 29.5"	340	Stacked Storage System Sideboard	455			
<b>Oslo Chair Series</b>	<b>342</b>	Stacked Storage System Podium	465			
Oslo Counter Stool 65 cm / 25.6"	343	465	460	<b>ACCESSORIES</b>		
Oslo Bar Stool 75 cm / 29.5"	344	<b>Still Café Table</b>	<b>466</b>	<b>Ample Throw</b>	<b>571</b>	
Made-To-Order Options: Oslo Chairs &	345	<b>Visu Chair Series</b>	<b>476</b>	<b>Arced Mirror</b>	<b>573</b>	
Stools	345	Visu Chair Wood Base	477	<b>Arrange Desktop Series</b>	<b>576</b>	
<b>Oslo Lounge Series</b>	<b>346</b>	Visu Chair Tube Base	478	<b>Attach Coat Hook</b>	<b>582</b>	
Oslo Lounge Chair Swivel Base	347	Visu Chair Sled Base	479	<b>Avail Coat Rack</b>	<b>584</b>	
Oslo Lounge Chair Tube Base	348	Visu Lounge Chair Wood Base	480	<b>Coil Coat Rack</b>	<b>586</b>	
Made-To-Order Options: Oslo Lounge	349	Visu Counter Stool Wood Base - 65 cm /	481	<b>Compile Bookend</b>	<b>589</b>	
<b>Oslo Sofa Series</b>	<b>350</b>	25.6"	481	<b>Corky Series</b>	<b>591</b>	
Oslo Sofa 2-Seater	351	Visu Bar Stool Wood Base - 75 cm / 29.5"	482	Corky Glasses Set of 4	592	
Oslo Sofa 3-Seater	352	Cover and Visu Chair Transport	482	Corky Carafe	593	
Made-To-Order Options	353	Trolley	483	<b>Dots Series</b>	<b>594</b>	
<b>Outline Sofa Series</b>	<b>354</b>	Made-To-Order Options	484	Dots Wood	595	
Outline Sofa 2-Seater	356	<b>Workshop Series</b>	<b>488</b>	Dots Metal	603	
Outline Sofa 3-Seater	358	Workshop Chair	489	Dots Ceramic	607	
Outline Chair	360	Workshop Table	490	<b>Folded Shelves</b>	<b>609</b>	
Outline Daybed	362	Workshop Coffee Table	493	Folded Shelves	610	
Outline Daybed Cushion	363	Workshop Bench	495	Folded Platform Shelf	614	
Made-To-Order Options: Outline Series	364	<b>Wrap Lounge Chair</b>	<b>496</b>	<b>Framed Mirror</b>	<b>615</b>	
Made-To-Order Options: Outline	364	Wrap Lounge Chair	497	<b>Groove Trivet</b>	<b>618</b>	
Studio Series	366	Made-To-Order Options: Wrap Lounge	498	<b>Kink Vase</b>	<b>620</b>	
<b>Outline Highback Sofa Series</b>	<b>368</b>	Chair	498	<b>Layer Cushion</b>	<b>622</b>	
Outline Highback Sofa 100 1-Seater	371	<b>LIGHTING</b>		<b>Mere Bowl</b>	<b>625</b>	
Outline Highback Sofa 100 2-Seater	373	<b>Ambit Lamp Series</b>	<b>500</b>	<b>Mingle Cushion</b>	<b>628</b>	
Outline Highback Work 100 1-Seater	375	Ambit Pendant Lamp	501	<b>Pebble Rug</b>	<b>631</b>	
Made-To-Order Options: Outline	379	Ambit Rail Lamp	505	<b>Platform Tray</b>	<b>634</b>	
Highback Series	379	Ambit Wall Lamp	506	<b>Ply Rug</b>	<b>636</b>	
				<b>Raise Series</b>	<b>645</b>	
				Raise Carafe	646	

Raise Glasses Set of 2	647	Restore Round Basket	656	Tub Jug	671
Reduce Paper Bin	648	Rhythm Throw	657	Twine Cushion	673
Relevo Rug	650	Ridge Series	659	Varjo Rug	675
Restore Series	653	Silent Vase	663	Wave Tray	678
Restore Basket	654	Sketch Toolbox	667	<b>COLOR CODE INDEX</b>	<b>680</b>
Restore Tray	655	Story Pinboard	669	<b>UPHOLSTERY OVERVIEW</b>	<b>693</b>



# FURNITURE

# 70/70 TABLE

FOR MORE INFORMATION,  
EXPLORE BELOW

- ↗ [Product Fact Sheet](#)
- ↗ [Images](#)
- ↗ [Architect Files](#)
- ↗ [Assembly Instructions](#)
- ↗ [Product Declaration](#)

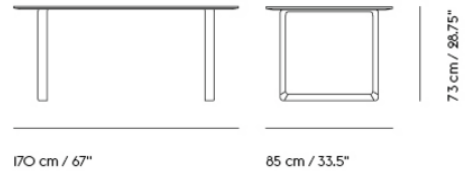

Shipper Colli	2
Gross Weight (kg)	46.31
Net Weight (kg)	39.6
Base color options	Anthracite Black, Grey, Sand or White
Warranty Period	10 years

Pattern No.	Color	Contract Price	Lead Time
<b>Ready-To-Ship US Warehouse</b>			
M7070T6734L-BLCK-WHIT	White Laminate/Plywood/Anthracite Black	USD 2,256.00	-
M7070T6734L-GREY-WHIT	White Laminate/Plywood/Grey	USD 2,256.00	-
M7070T6734L-SAND-WHIT	White Laminate/Plywood/Sand	USD 2,256.00	-
M7070T6734L-WHIT-WHIT	White Laminate/Plywood/White	USD 2,256.00	-
M7070T6734V-BLCK-OAK	Oak Veneer/Plywood/Anthracite Black	USD 2,571.00	-
M7070T6734V-GREY-OAK	Oak Veneer/Plywood/Grey	USD 2,571.00	-
M7070T6734V-SAND-OAK	Oak Veneer/Plywood/Sand	USD 2,571.00	-
M7070T6734V-WHIT-OAK	Oak Veneer/Plywood/White	USD 2,571.00	-
M7070T6734O-BLCK-BLCK	Black Linoleum/Plywood/Anthracite Black	USD 2,256.00	-
M7070T6734O-GREY-BLCK	Black Linoleum/Plywood/Grey	USD 2,256.00	-
M7070T6734O-SAND-BLCK	Black Linoleum/Plywood/Sand	USD 2,256.00	-
M7070T6734O-WHIT-BLCK	Black Linoleum/Plywood/White	USD 2,256.00	-
M7070T6734O-SAND-GREY	Grey Linoleum/Plywood/Sand	USD 2,256.00	-
M7070T6734W-BLCK-SOAK	Solid Oak/Anthracite Black	USD 3,306.00	-
M7070T6734W-GREY-SOAK	Solid Oak/Grey	USD 3,306.00	-
M7070T6734W-SAND-SOAK	Solid Oak/Sand	USD 3,306.00	-
M7070T6734W-BLCK-SMOAK	Solid Smoked Oak/Anthracite Black	USD 3,516.00	-
M7070T6734W-GREY-SMOAK	Solid Smoked Oak/Grey	USD 3,516.00	-



Pattern No.	Color	Contract Price	Lead Time
M7070T6734W-SAND-SMOAK	Solid Smoked Oak/Sand	USD 3,516.00	-
M7070T6734W-WHIT-SMOAK	Solid Smoked Oak/White	USD 3,516.00	-

**Ready-To-Ship EU  
Warehouse**

M7070T6734O-BLCK-GREY	Grey Linoleum/Plywood/Anthracite Black	USD 2,256.00	-
M7070T6734O-GREY-GREY	Grey Linoleum/Plywood/Grey	USD 2,256.00	-
M7070T6734O-WHIT-GREY	Grey Linoleum/Plywood/White	USD 2,256.00	-
M7070T6734W-WHIT-SOAK	Solid Oak/White	USD 3,306.00	-

# 70/70 TABLE / 225 X 90 CM / 88.5 X 35.5"

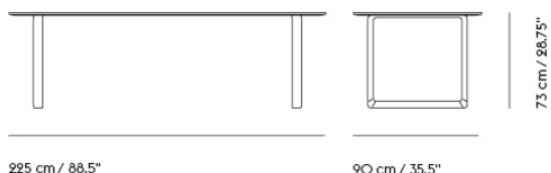

Shipper Colli	2
Gross Weight (kg)	78.8l
Net Weight (kg)	72.l
Base color options	Anthracite Black, Grey, Sand or White
Warranty Period	10 years

Pattern No.	Color	Contract Price	Lead Time
<b>Ready-To-Ship US Warehouse</b>			
M7070T8936L-BLCK-WHIT	White Laminate/Plywood/Anthracite Black	USD 3,040.00	-
M7070T8936L-GREY-WHIT	White Laminate/Plywood/Grey	USD 3,040.00	-
M7070T8936L-SAND-WHIT	White Laminate/Plywood/Sand	USD 3,040.00	-
M7070T8936L-WHIT-WHIT	White Laminate/Plywood/White	USD 3,040.00	-
M7070T8936V-BLCK-OAK	Oak Veneer/Plywood/Anthracite Black	USD 3,306.00	-
M7070T8936V-GREY-OAK	Oak Veneer/Plywood/Grey	USD 3,306.00	-
M7070T8936V-SAND-OAK	Oak Veneer/Plywood/Sand	USD 3,306.00	-
M7070T8936V-WHIT-OAK	Oak Veneer/Plywood/White	USD 3,306.00	-
M7070T8936O-BLCK-BLCK	Black Linoleum/Plywood/Anthracite Black	USD 3,040.00	-
M7070T8936O-GREY-BLCK	Black Linoleum/Plywood/Grey	USD 3,040.00	-
M7070T8936O-SAND-BLCK	Black Linoleum/Plywood/Sand	USD 3,040.00	-
M7070T8936O-WHIT-BLCK	Black Linoleum/Plywood/White	USD 3,040.00	-
M7070T8936O-SAND-GREY	Grey Linoleum/Plywood/Sand	USD 3,040.00	-
M7070T8936W-BLCK-SOAK	Solid Oak/Anthracite Black	USD 4,566.00	-
M7070T8936W-GREY-SOAK	Solid Oak/Grey	USD 4,566.00	-
M7070T8936W-SAND-SOAK	Solid Oak/Sand	USD 4,566.00	-
M7070T8936W-WHIT-SOAK	Solid Oak/White	USD 4,566.00	-
M7070T8936W-BLCK-SMOAK	Solid Smoked Oak/Anthracite Black	USD 4,671.00	-
M7070T8936W-GREY-SMOAK	Solid Smoked Oak/Grey	USD 4,671.00	-

Pattern No.	Color	Contract Price	Lead Time
M7070T8936W-SAND-SMOAK	Solid Smoked Oak/Sand	USD 4,671.00	-
M7070T8936W-WHIT-SMOAK	Solid Smoked Oak/White	USD 4,671.00	-

**Ready-To-Ship EU  
Warehouse**

M7070T8936O-BLCK-GREY	Grey Linoleum/Plywood/Anthracite Black	USD 3,040.00	-
M7070T8936O-GREY-GREY	Grey Linoleum/Plywood/Grey	USD 3,040.00	-
M7070T8936O-WHIT-GREY	Grey Linoleum/Plywood/White	USD 3,040.00	-



# 70/70 TABLE / 255 X 108 CM / 100.5 X 42.5"

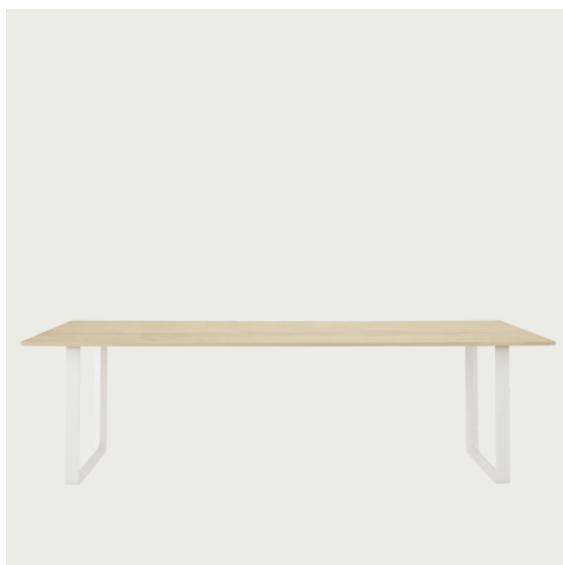

255 cm / 100.5"

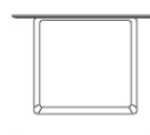

73 cm / 28.75"

108 cm / 42.5"

Shipper Colli	2
Gross Weight (kg)	100.85
Net Weight (kg)	92
Base color options	Anthracite Black, Grey, Sand or White
Warranty Period	10 years

Pattern No.	Color	Contract Price	Lead Time
<b>Ready-To-Ship US Warehouse</b>			
M7070T10143L-BLCK-WHIT	White Laminate/Plywood/Anthracite Black	USD 3,145.00	-
M7070T10143L-GREY-WHIT	White Laminate/Plywood/Grey	USD 3,145.00	-
M7070T10143L-SAND-WHIT	White Laminate/Plywood/Sand	USD 3,145.00	-
M7070T10143L-WHIT-WHIT	White Laminate/Plywood/White	USD 3,145.00	-
M7070T10143V-BLCK-OAK	Oak Veneer/Plywood/Anthracite Black	USD 3,621.00	-
M7070T10143V-GREY-OAK	Oak Veneer/Plywood/Grey	USD 3,621.00	-
M7070T10143V-SAND-OAK	Oak Veneer/Plywood/Sand	USD 3,621.00	-
M7070T10143V-WHIT-OAK	Oak Veneer/Plywood/White	USD 3,621.00	-
M7070T10143O-BLCK-BLCK	Black Linoleum/Plywood/Anthracite Black	USD 3,145.00	-
M7070T10143O-GREY-BLCK	Black Linoleum/Plywood/Grey	USD 3,145.00	-
M7070T10143O-SAND-BLCK	Black Linoleum/Plywood/Sand	USD 3,145.00	-
M7070T10143O-WHIT-BLCK	Black Linoleum/Plywood/White	USD 3,145.00	-
M7070T10143W-BLCK-SOAK	Solid Oak/Anthracite Black	USD 5,770.00	-
M7070T10143W-GREY-SOAK	Solid Oak/Grey	USD 5,770.00	-
M7070T10143W-SAND-SOAK	Solid Oak/Sand	USD 5,770.00	-
M7070T10143W-WHIT-SOAK	Solid Oak/White	USD 5,770.00	-

Pattern No.	Color	Contract Price	Lead Time
M7070T10143W-BLCK-SMOAK	Solid Smoked Oak/Anthracite Black	USD 6,141.00	-
M7070T10143W-GREY-SMOAK	Solid Smoked Oak/Grey	USD 6,141.00	-
M7070T10143W-SAND-SMOAK	Solid Smoked Oak/Sand	USD 6,141.00	-
M7070T10143W-WHIT-SMOAK	Solid Smoked Oak/White	USD 6,141.00	-

#### Ready-To-Ship EU Warehouse

M7070T10143O-BLCK-GREY	Grey Linoleum/Plywood/Anthracite Black	USD 3,145.00	-
M7070T10143O-GREY-GREY	Grey Linoleum/Plywood/Grey	USD 3,145.00	-
M7070T10143O-SAND-GREY	Grey Linoleum/Plywood/Sand	USD 3,145.00	-
M7070T10143O-WHIT-GREY	Grey Linoleum/Plywood/White	USD 3,145.00	-

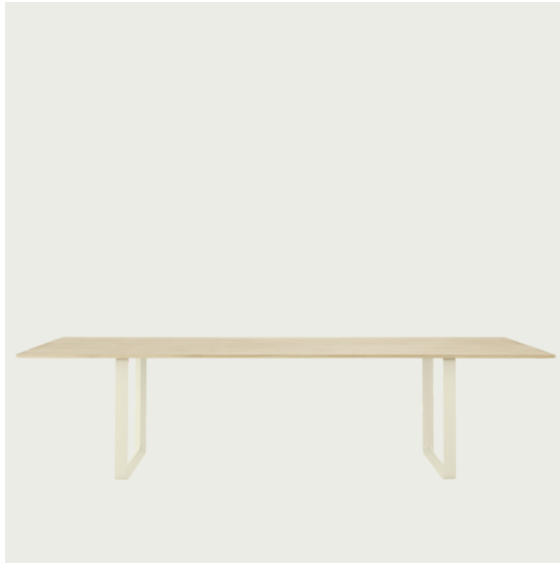

295 cm / 116.1"

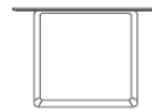

73 cm / 28.75"

108 cm / 42.5"

<b>Shipper Colli</b>	2
<b>Gross Weight (kg)</b>	111.65
<b>Net Weight (kg)</b>	102.8
<b>Base color options</b>	Anthracite Black, Grey, Sand or White
<b>Warranty Period</b>	10 years

Pattern No.	Color	Contract Price	Lead Time
<b>Ready-To-Ship US Warehouse</b>			
M7070T11643L-BLCK-WHIT	White Laminate/Plywood/Anthracite Black	USD 3,355.00	-
M7070T11643L-GREY-WHIT	White Laminate/Plywood/Grey	USD 3,355.00	-
M7070T11643L-WHIT-WHIT	White Laminate/Plywood/White	USD 3,355.00	-
M7070T11643V-BLCK-OAK	Oak Veneer/Plywood/Anthracite Black	USD 3,880.00	-
M7070T11643V-GREY-OAK	Oak Veneer/Plywood/Grey	USD 3,880.00	-
M7070T11643V-SAND-OAK	Oak Veneer/Plywood/Sand	USD 3,880.00	-
M7070T11643V-WHIT-OAK	Oak Veneer/Plywood/White	USD 3,880.00	-
M7070T11643O-BLCK-BLCK	Black Linoleum/Plywood/Anthracite Black	USD 3,355.00	-
M7070T11643O-GREY-BLCK	Black Linoleum/Plywood/Grey	USD 3,355.00	-
M7070T11643O-SAND-BLCK	Black Linoleum/Plywood/Sand	USD 3,355.00	-
M7070T11643O-WHIT-BLCK	Black Linoleum/Plywood/White	USD 3,355.00	-
M7070T11643W-BLCK-SOAK	Solid Oak/Anthracite Black	USD 6,351.00	-
M7070T11643W-GREY-SOAK	Solid Oak/Grey	USD 6,351.00	-
M7070T11643W-SAND-SOAK	Solid Oak/Sand	USD 6,351.00	-
M7070T11643W-WHIT-SOAK	Solid Oak/White	USD 6,351.00	-
M7070T11643W-BLCK-SMOAK	Solid Smoked Oak/Anthracite Black	USD 6,715.00	-



Pattern No.	Color	Contract Price	Lead Time
M7070T11643W-GREY-SMOAK	Solid Smoked Oak/Grey	USD 6,715.00	-
M7070T11643W-SAND-SMOAK	Solid Smoked Oak/Sand	USD 6,715.00	-
M7070T11643W-WHIT-SMOAK	Solid Smoked Oak/White	USD 6,715.00	-

#### Ready-To-Ship EU Warehouse

M7070T11643L-SAND-WHIT	White Laminate/Plywood/Sand	USD 3,355.00	-
M7070T11643O-BLCK-GREY	Grey Linoleum/Plywood/Anthracite Black	USD 3,355.00	-
M7070T11643O-GREY-GREY	Grey Linoleum/Plywood/Grey	USD 3,355.00	-
M7070T11643O-SAND-GREY	Grey Linoleum/Plywood/Sand	USD 3,355.00	-
M7070T11643O-WHIT-GREY	Grey Linoleum/Plywood/White	USD 3,355.00	-



All Variants

Sizes	Pattern No.	Width	Depth	Height	Contract Price					
					Laminate (L)	Linoleum (O)	Oak veneer (V)	Nanolaminate (N)	Solid Oak (W)	Solid Smoked Oak (W)
70/70 Table / 170 X 85 CM / 67 X 33.5"	M-7070T-6734-	67"	34"	28.75"	2,256	2,256	2,571	2,571	3,040	3,145
70/70 Table / 225 X 90 CM / 88.5 X 35.5"	M-7070T-8936-	88.5"	35.5"	28.75"	3,040	3,040	3,306	3,355	3,985	4,146
70/70 Table / 255 X 108 CM / 100.5 X 42.5"	M-7070T-10143-	100.5"	42.5"	28.75"	3,145	3,145	3,621	3,565	4,510	4,986
70/70 Table / 295 X 108 CM / 116 X 42.5"	M-7070T-11643-	116"	42.5"	28.75"	3,355	3,355	3,880	3,831	5,511	5,875

HOW TO CONFIGURE

ORDER CODE EXAMPLE

Specify:

70/70 Table 100.5 x 42.5" with oak veneer table top and black base

- Step 1) Select Size
- Step 2) Select table top material
- Step 3) Select Base color
- Step 4) Select Table top color

Size	255 X 108 CM / 100.5 X 42.5"	M-7070T-10143-
Table top material	Veneer	V
Base color	Black base	BLCK
Table top finish	Oak veneer	OAK
Final Pattern No.	M7070T10143VBLCKOAK	

Table Top Material	Base Color Options	Table Top Finish
L - Laminate O - Linoleum V - Veneer N - Nanolaminate W - Solid Wood	WHIT - White BLCK - Black GREY - Grey SAND - Sand	Laminate WHIT - White  Linoleum BLCK - Black GREY - Grey  Veneer OAK - Oak  Nanolaminate WHIT - White BLCK - Black GREY - Grey  Solid Wood SOAK - W1 Solid Oak SMOAK - W2 Solid Smoked Oak

# 70/70 OUTDOOR TABLE

FOR MORE INFORMATION,  
EXPLORE BELOW

- ↗ [Product Fact Sheet](#)
- ↗ [Images](#)
- ↗ [Architect Files](#)
- ↗ [Product Declaration](#)

**70/70 OUTDOOR TABLE / 225 X 90 CM / 88.5 X 35.5"**

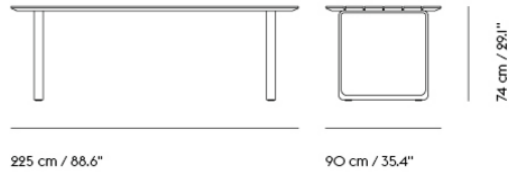

<b>Shipper Colli</b>	2
<b>Gross Weight (kg)</b>	78.8l
<b>Net Weight (kg)</b>	72.1
<b>Base color options</b>	Anthracite Black, Grey
<b>Warranty Period</b>	10 years

Pattern No.	Color	Contract Price	Lead Time
<b>Ready-To-Ship US Warehouse</b>			
M7070TO8936M-BLCK-MHGY	Sapele Mahogany/Anthracite Black	USD 4,041.00	-
M7070TO8936M-GREY-MHGY	Sapele Mahogany/Grey	USD 4,041.00	-
<b>Extras</b>			
MODCV-BLCK	Outdoor Cover for 70/70 Outdoor Table and Linear Steel Table 220 x 90 CM / 86.6 x 35.5"	USD 299.00	-

# AIRY COFFEE TABLE

FOR MORE INFORMATION,  
EXPLORE BELOW

- ↗ [Product Fact Sheet](#)
- ↗ [Images](#)
- ↗ [Architect Files](#)
- ↗ [Assembly Instructions](#)
- ↗ [Product Declaration](#)

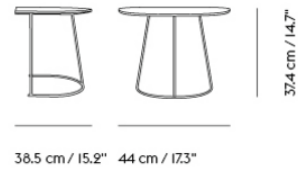

**Shipper Colli** 2  
**Gross Weight (kg)** 4.514  
**Net Weight (kg)** 3.1  
**Warranty Period** 5 years

Pattern No.	Color	Contract Price	Lead Time
<b>Ready-To-Ship US Warehouse</b>			
MARYCT161715N-BLCK	Black Nanolaminate/Black	USD 331.00	-
MARYCT161715N-GREY	Grey Nanolaminate/Grey	USD 331.00	-
MARYCT161715N-OWHT	Off-White Nanolaminate/Off-White	USD 331.00	-
<b>Ready-To-Ship EU Warehouse</b>			
MARYCT161715N-PLUM	Plum Nanolaminate/Plum ***	USD 331.00	-

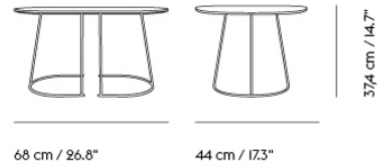

**Shipper Colli** 2  
**Gross Weight (kg)** 6.262  
**Net Weight (kg)** 4.71  
**Warranty Period** 5 years

Pattern No.	Color	Contract Price	Lead Time
<b>Ready-To-Ship US Warehouse</b>			
MARYCT271715N-BLCK	Black Nanolaminate/Black	USD 530.00	-
MARYCT271715N-GREY	Grey Nanolaminate/Grey	USD 530.00	-
MARYCT271715N-OWHT	Off-White Nanolaminate/Off-White	USD 530.00	-
MARYCT271715N-PLUM	Plum Nanolaminate/Plum	USD 530.00	-



**Shipper Colli** 2  
**Gross Weight (kg)** 7.852  
**Net Weight (kg)** 6.21  
**Warranty Period** 5 years

Pattern No.	Color	Contract Price	Lead Time
<b>Ready-To-Ship US Warehouse</b>			
MARYCT352015N-BLCK	Black Nanolaminate/Black	USD 614.00	-
MARYCT352015N-GREY	Grey Nanolaminate/Grey	USD 614.00	-
MARYCT352015N-OWHT	Off-White Nanolaminate/Off-White	USD 614.00	-
MARYCT352015N-PLUM	Plum Nanolaminate/Plum	USD 614.00	-



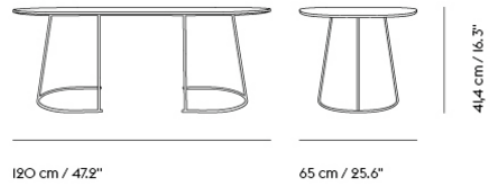

**Shipper Colli** 2  
**Gross Weight (kg)** 11.646  
**Net Weight (kg)** 9.56  
**Warranty Period** 5 years

Pattern No.	Color	Contract Price	Lead Time
<b>Ready-To-Ship US Warehouse</b>			
MARYCT472616N-BLCK	Black Nanolaminate/Black	USD 797.00	-
MARYCT472616N-GREY	Grey Nanolaminate/Grey	USD 797.00	-
MARYCT472616N-OWHT	Off-White Nanolaminate/Off-White	USD 797.00	-
MARYCT472616N-PLUM	Plum Nanolaminate/Plum	USD 797.00	-

# AROUND COFFEE TABLE

FOR MORE INFORMATION,  
EXPLORE BELOW

- ↗ [Product Fact Sheet](#)
- ↗ [Images](#)
- ↗ [Architect Files](#)
- ↗ [Assembly Instructions](#)
- ↗ [Product Declaration](#)

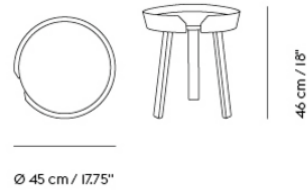

**Shipper Colli** 1  
**Gross Weight (kg)** 3.82  
**Net Weight (kg)** 2.94  
**Warranty Period** 5 years

Pattern No.	Color	Contract Price	Lead Time
<b>Ready-To-Ship US Warehouse</b>			
MARDCT1818-OAK	Oak	USD 576.00	-
MARDCT1818-ANTH	Anthracite	USD 576.00	-
MARDCT1818-ASH	Ash	USD 576.00	-
MARDCT1818-BLCK	Black	USD 576.00	-
MARDCT1818-DKGN	Dark Green	USD 576.00	-
MARDCT1818-DGRN	Dusty Green	USD 576.00	-
MARDCT1818-GREY	Grey	USD 576.00	-
MARDCT1818-LTBU	Light Blue	USD 576.00	-
MARDCT1818-STDB	Stained Dark Brown	USD 576.00	-
MARDCT1818-TROS	Tan Rose	USD 576.00	-
MARDCT1818-WHIT	White	USD 576.00	-

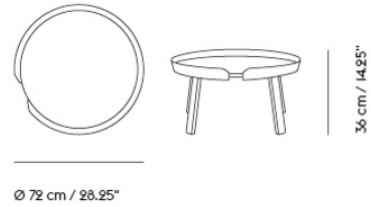

**Shipper Colli** 1  
**Gross Weight (kg)** 7.06  
**Net Weight (kg)** 5.92  
**Warranty Period** 5 years

Pattern No.	Color	Contract Price	Lead Time
<b>Ready-To-Ship US Warehouse</b>			
MARDCT2814-OAK	Oak	USD 933.00	-
MARDCT2814-ANTH	Anthracite	USD 933.00	-
MARDCT2814-ASH	Ash	USD 933.00	-
MARDCT2814-BLCK	Black	USD 933.00	-
MARDCT2814-DGRN	Dusty Green	USD 933.00	-
MARDCT2814-GREY	Grey	USD 933.00	-
MARDCT2814-STDB	Stained Dark Brown	USD 933.00	-
MARDCT2814-WHIT	White	USD 933.00	-
<b>Ready-To-Ship EU Warehouse</b>			
MARDCT2814-DKGN	Dark Green	USD 933.00	-

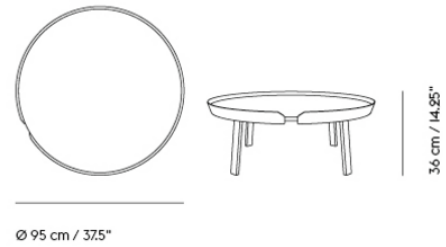

**Shipper Colli** 1  
**Gross Weight (kg)** 13.06  
**Net Weight (kg)** 10.52  
**Warranty Period** 5 years

Pattern No.	Color	Contract Price	Lead Time
<b>Ready-To-Ship US Warehouse</b>			
MARDCT3814-OAK	Oak	USD 1,206.00	-
MARDCT3814-ANTH	Anthracite	USD 1,206.00	-
MARDCT3814-ASH	Ash	USD 1,206.00	-
MARDCT3814-BLCK	Black	USD 1,206.00	-
MARDCT3814-DGRN	Dusty Green	USD 1,206.00	-
MARDCT3814-GREY	Grey	USD 1,206.00	-
MARDCT3814-STDB	Stained Dark Brown	USD 1,206.00	-
MARDCT3814-WHIT	White	USD 1,206.00	-

# BASE TABLE SERIES

FOR MORE INFORMATION,  
EXPLORE BELOW

- ↗ [Product Fact Sheet](#)
- ↗ [Images](#)
- ↗ [Architect Files](#)
- ↗ [Assembly Instructions](#)
- ↗ [Product Declaration](#)

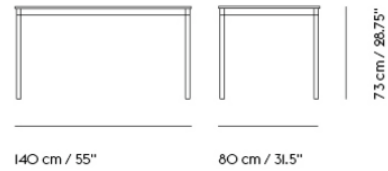

Shipper Colli	2
Gross Weight (kg)	25.7
Net Weight (kg)	22.3
Warranty Period	10 years

Pattern No.	Color	Contract Price	Lead Time
<b>Ready-To-Ship US Warehouse</b>			
MBTR553229LN-BLCK-WHIT-PLY	White Laminate/Plywood/Black	USD 1,626.00	-
MBTR553229LN-WHIT-WHIT-PLY	White Laminate/Plywood/White	USD 1,626.00	-
MBTR553229LN-BLCK-WHIT-WHIT	White Laminate/White ABS/Black	USD 1,626.00	-
MBTR553229LN-WHIT-WHIT-WHIT	White Laminate/White ABS/White	USD 1,626.00	-
MBTR553229VN-BLCK-OAK-PLY	Lacquered Oak Veneer/Plywood/Black	USD 2,046.00	-
MBTR553229VN-WHIT-OAK-PLY	Lacquered Oak Veneer/Plywood/White	USD 2,046.00	-
MBTR553229ON-BLCK-BLCK-PLY	Black Linoleum/Plywood/Black	USD 1,731.00	-
<b>Ready-To-Ship EU Warehouse</b>			
MBTR553229ON-WHIT-BLCK-PLY	Black Linoleum/Plywood/White	USD 1,731.00	-

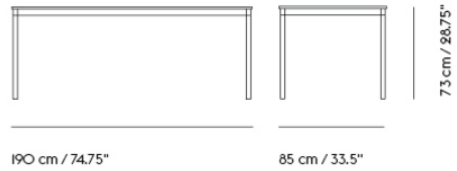

Shipper Colli	2
Gross Weight (kg)	33.9
Net Weight (kg)	28.09
Warranty Period	10 years

Pattern No.	Color	Contract Price	Lead Time
<b>Ready-To-Ship US Warehouse</b>			
MBTR753429LN-BLCK-WHIT-PLY	White Laminate/Plywood/Black	USD 1,836.00	-
MBTR753429LN-WHIT-WHIT-PLY	White Laminate/Plywood/White	USD 1,836.00	-
MBTR753429LN-BLCK-WHIT-WHIT	White Laminate/White ABS/Black	USD 1,836.00	-
MBTR753429LN-WHIT-WHIT-WHIT	White Laminate/White ABS/White	USD 1,836.00	-
MBTR753429VN-BLCK-OAK-PLY	Lacquered Oak Veneer/Plywood/Black	USD 2,515.00	-
MBTR753429VN-WHIT-OAK-PLY	Lacquered Oak Veneer/Plywood/White	USD 2,515.00	-
MBTR753429ON-BLCK-BLCK-PLY	Black Linoleum/Plywood/Black	USD 2,151.00	-
MBTR753429ON-WHIT-BLCK-PLY	Black Linoleum/Plywood/White	USD 2,151.00	-



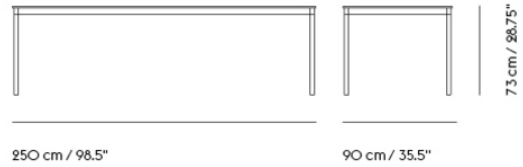

**Shipper Colli** 2  
**Gross Weight (kg)** 46.7  
**Net Weight (kg)** 40.08  
**Warranty Period** 10 years

Pattern No.	Color	Contract Price	Lead Time
<b>Ready-To-Ship US Warehouse</b>			
MBTR993629LN-BLCK-WHIT-PLY	White Laminate/Plywood/Black	USD 2,515.00	-
MBTR993629LN-WHIT-WHIT-PLY	White Laminate/Plywood/White	USD 2,515.00	-
MBTR993629LN-BLCK-WHIT-WHIT	White Laminate/White ABS/Black	USD 2,515.00	-
MBTR993629LN-WHIT-WHIT-WHIT	White Laminate/White ABS/White	USD 2,515.00	-
MBTR993629VN-BLCK-OAK-PLY	Lacquered Oak Veneer/Plywood/Black	USD 3,411.00	-
MBTR993629VN-WHIT-OAK-PLY	Lacquered Oak Veneer/Plywood/White	USD 3,411.00	-
MBTR993629ON-BLCK-BLCK-PLY	Black Linoleum/Plywood/Black	USD 3,040.00	-
MBTR993629ON-WHIT-BLCK-PLY	Black Linoleum/Plywood/White	USD 3,040.00	-

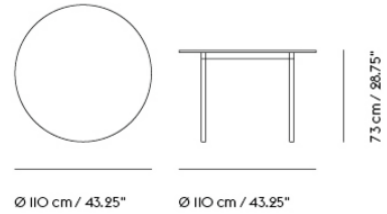

**Shipper Colli** 2  
**Gross Weight (kg)** 19.1  
**Net Weight (kg)** 14  
**Warranty Period** 10 years

Pattern No.	Color	Contract Price	Lead Time
<b>Ready-To-Ship EU Warehouse</b>			
MBTO4329LN-BLCK-WHIT-PLY	White Laminate/Plywood/Black	USD 1,626.00	-
MBTO4329LN-WHIT-WHIT-PLY	White Laminate/Plywood/White	USD 1,626.00	-
MBTO4329ON-BLCK-BLCK-PLY	Black Linoleum/Plywood/Black	USD 1,836.00	-
MBTO4329ON-WHIT-BLCK-PLY	Black Linoleum/Plywood/White	USD 1,836.00	-

# BASE HIGH TABLE / 190 X 50 H: 95 CM / 74.8 X 19.7 H: 37.4"



Shipper Colli	2
Gross Weight (kg)	38
Net Weight (kg)	33.2
Warranty Period	10 years

Pattern No.	Color	Contract Price	Lead Time
<b>Ready-To-Ship US Warehouse</b>			
MBHTR752038LN-BLCK-WHIT-PLY	White Laminate/Plywood/Black	USD 2,676.00	-
MBHTR752038LN-WHIT-WHIT-PLY	White Laminate/Plywood/White	USD 2,676.00	-
MBHTR752038LN-BLCK-WHIT-WHIT	White Laminate/White ABS/Black	USD 2,676.00	-
MBHTR752038LN-WHIT-WHIT-WHIT	White Laminate/White ABS/White	USD 2,676.00	-
MBHTR752038VN-BLCK-OAK-PLY	Lacquered Oak Veneer/Plywood/Black	USD 3,355.00	-
MBHTR752038VN-WHIT-OAK-PLY	Lacquered Oak Veneer/Plywood/White	USD 3,355.00	-
MBHTR752038ON-BLCK-BLCK-PLY	Black Linoleum/Plywood/Black	USD 3,040.00	-
MBHTR752038ON-WHIT-BLCK-PLY	Black Linoleum/Plywood/White	USD 3,040.00	-

**BASE HIGH TABLE / 190 X 50 H: 105 CM / 74.8 X 19.7 H: 41.3"**

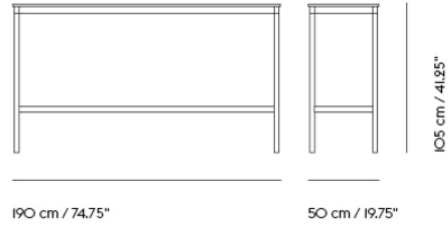

Shipper Colli 2  
 Gross Weight (kg) 39  
 Net Weight (kg) 34.2  
 Warranty Period 10 years

Pattern No.	Color	Contract Price	Lead Time
<b>Ready-To-Ship US Warehouse</b>			
MBHTR752041LN-BLCK-WHIT-PLY	White Laminate/Plywood/Black	USD 2,676.00	-
MBHTR752041LN-WHIT-WHIT-PLY	White Laminate/Plywood/White	USD 2,676.00	-
MBHTR752041LN-BLCK-WHIT-WHIT	White Laminate/White ABS/Black	USD 2,676.00	-
MBHTR752041LN-WHIT-WHIT-WHIT	White Laminate/White ABS/White	USD 2,676.00	-
MBHTR752041VN-BLCK-OAK-PLY	Lacquered Oak Veneer/Plywood/Black	USD 3,355.00	-
MBHTR752041VN-WHIT-OAK-PLY	Lacquered Oak Veneer/Plywood/White	USD 3,355.00	-
MBHTR752041ON-BLCK-BLCK-PLY	Black Linoleum/Plywood/Black	USD 3,040.00	-
MBHTR752041ON-WHIT-BLCK-PLY	Black Linoleum/Plywood/White	USD 3,040.00	-

**BASE HIGH TABLE / 190 X 85 H: 95 CM / 74.8 X 33.5 H: 37.4"**

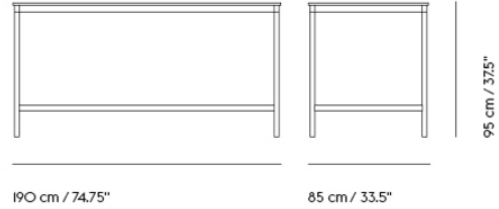

Shipper Colli 2  
 Gross Weight (kg) 44  
 Net Weight (kg) 37.25  
 Warranty Period 10 years

Pattern No.	Color	Contract Price	Lead Time
<b>Ready-To-Ship US Warehouse</b>			
MBHTR753438LN-BLCK-WHIT-PLY	White Laminate/Plywood/Black	USD 2,676.00	-
MBHTR753438LN-WHIT-WHIT-PLY	White Laminate/Plywood/White	USD 2,676.00	-
MBHTR753438LN-BLCK-WHIT-WHIT	White Laminate/White ABS/Black	USD 2,676.00	-
MBHTR753438LN-WHIT-WHIT-WHIT	White Laminate/White ABS/White	USD 2,676.00	-
MBHTR753438VN-BLCK-OAK-PLY	Lacquered Oak Veneer/Plywood/Black	USD 3,145.00	-
MBHTR753438VN-WHIT-OAK-PLY	Lacquered Oak Veneer/Plywood/White	USD 3,145.00	-
MBHTR753438ON-BLCK-BLCK-PLY	Black Linoleum/Plywood/Black	USD 3,040.00	-
MBHTR753438ON-WHIT-BLCK-PLY	Black Linoleum/Plywood/White	USD 3,040.00	-

**BASE HIGH TABLE / 190 X 85 H: 105 CM / 74.8 X 33.5 H: 41.3"**

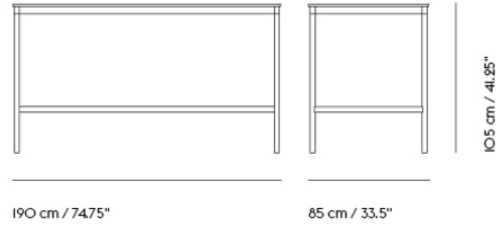

Shipper Colli 2  
 Gross Weight (kg) 45  
 Net Weight (kg) 38.25  
 Warranty Period 10 years

Pattern No.	Color	Contract Price	Lead Time
<b>Ready-To-Ship US Warehouse</b>			
MBHTR753441LN-BLCK-WHIT-PLY	White Laminate/Plywood/Black	USD 2,676.00	-
MBHTR753441LN-WHIT-WHIT-PLY	White Laminate/Plywood/White	USD 2,676.00	-
MBHTR753441LN-BLCK-WHIT-WHIT	White Laminate/White ABS/Black	USD 2,676.00	-
MBHTR753441LN-WHIT-WHIT-WHIT	White Laminate/White ABS/White	USD 2,676.00	-
MBHTR753441VN-BLCK-OAK-PLY	Lacquered Oak Veneer/Plywood/Black	USD 3,355.00	-
MBHTR753441VN-WHIT-OAK-PLY	Lacquered Oak Veneer/Plywood/White	USD 3,355.00	-
MBHTR753441ON-BLCK-BLCK-PLY	Black Linoleum/Plywood/Black	USD 3,040.00	-
MBHTR753441ON-WHIT-BLCK-PLY	Black Linoleum/Plywood/White	USD 3,040.00	-

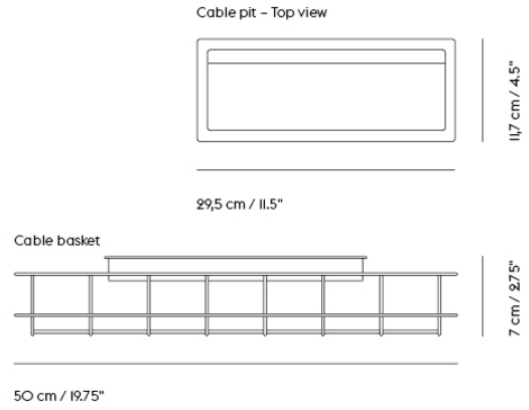

**Shipper Colli** 1  
**Gross Weight (kg)** 0.6133  
**Net Weight (kg)** 0.6133  
**Warranty Period** 5 years

Pattern No.	Color	Contract Price	Lead Time
<b>Ready-To-Ship US Warehouse</b>			
MCBLPIT	Aluminum	USD 341.00	-
MCBLBKT	Black	USD 341.00	-

# BASE TABLE

Shipper Colli 2  
 Warranty Period 5 years for L440 cm, L300 cm, L440 cm and Ø128 cm variants.  
 10 years for all other variants

All dimensions of the Base Table are identical, both with and without castors.

## All Variants

70 x 70 CM / 27.5 x 27.5 IN

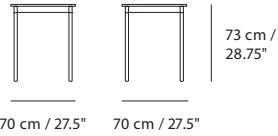

70 cm / 27.5" 70 cm / 27.5"

80 x 80 CM / 31.5 x 31.5 IN

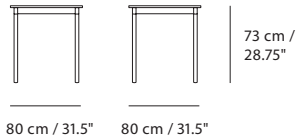

80 cm / 31.5" 80 cm / 31.5"

140 x 70 CM / 55 x 27.5 IN

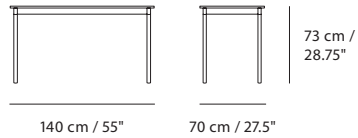

140 cm / 55" 70 cm / 27.5"

140 x 80 CM / 55 x 31.5 IN

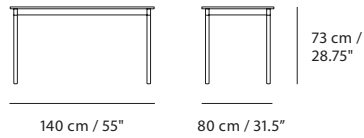

140 cm / 55" 80 cm / 31.5"

160 x 80 CM / 63 x 31.5 IN

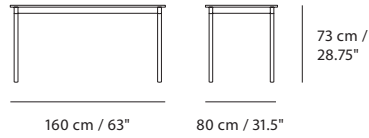

160 cm / 63" 80 cm / 31.5"

190 x 80 CM / 75 x 31.5 IN

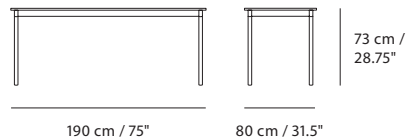

190 cm / 75" 80 cm / 31.5"

190 x 85 CM / 75 x 33.5 IN

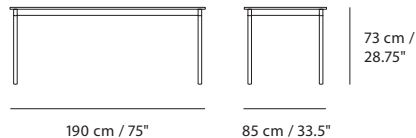

190 cm / 75" 85 cm / 33.5"

128 x 128 CM / 50.5 x 50.5 IN

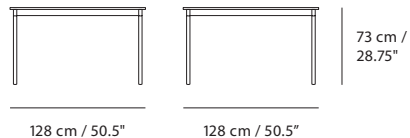

128 cm / 50.5" 128 cm / 50.5"

250 x 90 CM / 98.5 x 35.5 IN

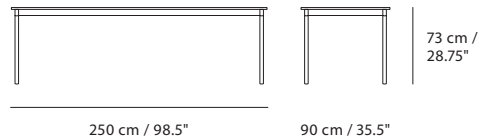

250 cm / 98.5" 90 cm / 35.5"

250 x 110 CM / 98.5 x 43.25 IN

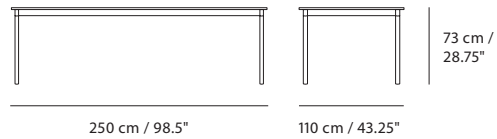

250 cm / 98.5" 110 cm / 43.25"

300 x 110 CM / 118 x 43.25 IN

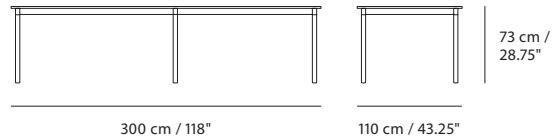

300 cm / 118" 110 cm / 43.25"

440 x 110 CM / 173.25 x 43.25 IN

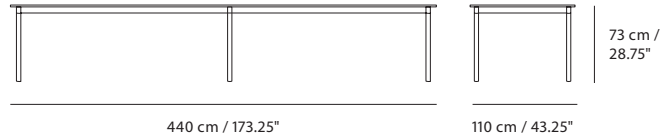

440 cm / 173.25" 110 cm / 43.25"

## BASE ROUND TABLE

Ø 90 CM / 35.5 IN

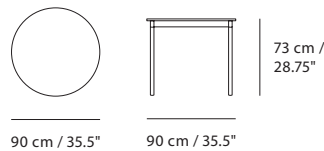

90 cm / 35.5" 90 cm / 35.5"

Ø 110 CM / 43.25 IN

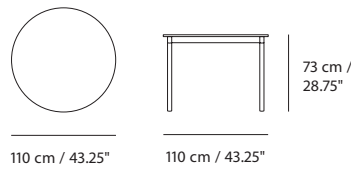

110 cm / 43.25" 110 cm / 43.25"

Ø 128 CM / 50.5 IN

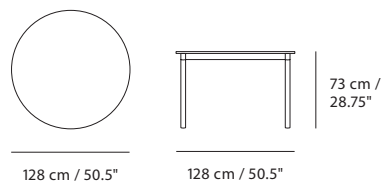

128 cm / 50.5" 128 cm / 50.5"



# BASE TABLE

## All Variants

Sizes	Pattern No.	Width/ diame- ter	Depth	Height	Weight (kg)		Contract Price				
								Laminate (L) w/ply- wood edge	Linoleum (O) w/plywood edge	Oak veneer (V) w/plywood edge	Nanolami- nate (N) w/plywood edge
<b>Base Table Rectangular</b>											
140 X 70 CM / 55.1 X 27.5"	M-BTR-55-28-29	55"	27.5"	28.75"	19.5	without castors	1,626	1,626	1,675	1,731	2,046
						with castors	1,731	1,731	1,885	2,046	2,256
140 X 80 CM / 55.1 X 31.5"	M-BTR-55-32-29	55"	31.5"	28.75"	23	without castors	1,626	1,626	1,731	2,046	2,256
						with castors	1,731	1,731	2,046	2,151	2,410
160 X 80 CM / 63 X 31.5 "	M-BTR-63-32-29	63"	31.5"	28.75"	23	without castors	1,836	1,836	2,046	2,151	2,305
						with castors	2,046	2,046	2,151	2,305	2,515
190 X 80 CM / 74.8 X 31.5"	M-BTR-75-32-29	74.75"	31.5"	28.75"	26	without castors	1,675	1,675	2,151	2,515	2,515
						with castors	1,885	1,885	2,305	2,676	2,676
190 X 85 CM / 74.8 X 33.5"	M-BTR-75-34-29	74.75"	33.5"	28.75"	30.5	without castors	1,836	1,836	2,151	2,515	2,571
						with castors	2,046	2,046	2,305	2,676	2,781
250 X 90 CM / 98.4 X 35.4"	M-BTR-99-36-29	98.5"	35.5"	28.75"	42	without castors	2,515	2,515	3,040	3,411	3,355
						with castors	2,676	2,676	3,145	3,621	3,565
250 X 110 CM / 98.4 X 43.3"	M-BTR-99-43-29	98.5"	43.5"	28.75"	47.5	without castors	2,676	2,676	3,355	3,565	3,411
						with castors	2,886	2,886	3,565	3,831	3,565
300 X 110 CM / 118.1 X 43.3"	M-BTR-118-43-29	118"	43.5"	28.75"	50	without castors	3,145	3,145	3,621	3,831	3,621
						with castors	3,355	3,355	3,880	3,985	3,880
440 X 110 CM / 173.3 X 43.3"	M-BTR-173-43-29	173"	43.5"	28.75"	64.5	without castors	3,985	3,985	4,986	5,035	4,776
						with castors	4,146	4,146	5,035	5,245	4,986
<b>Base Table Square</b>											
70 X 70 CM / 27.6 X 27.6"	M-BTS-28-28-29	27.5"	27.5"	28.75"	13	without castors	1,570	1,570	1,570	1,570	2,046
						with castors	1,675	1,675	1,731	1,731	2,151
80 X 80 CM / 31.5 X 31.5"	M-BTS-32-32-29	31.5"	31.5"	28.75"	15	without castors	1,570	1,570	1,570	1,626	2,046
						with castors	1,731	1,731	1,731	1,836	2,256
128 X 128 CM / 50.4 X 50.4"	M-BTS-51-51-29	50.5"	50.5"	28.75"	27	without castors	1,836	1,836	2,151	2,151	2,305
						with castors	2,095	2,095	2,305	2,305	2,515
<b>Base Round Table</b>											
Ø 90 CM / 35.4"	M-BTO-36-29	35.5"		28.75"	13.5	without castors	1,626	1,626	1,731	1,836	2,151
						with castors	1,731	1,731	2,046	2,046	2,305
Ø 110 CM / 43.3 "	M-BTO-43-29	43.5"		28.75"	17.5	without castors	1,626	1,626	1,836	1,836	2,151
						with castors	1,836	1,836	2,046	2,095	2,305
Ø 128 CM / 50.4"	M-BTO-51-29	50.5"		28.75"	21.5	without castors	1,626	1,626	2,046	2,046	2,256
						with castors	1,836	1,836	2,151	2,256	2,410

### HOW TO CONFIGURE

### ORDER CODE EXAMPLE

Specify:

Base Table 28x28" in white laminate and white base

- Step 1) Select size
- Step 2) Select table top material"
- Step 3) Select castors (C) or without castors (N)"
- Step 4) Select base color"
- Step 5) Select table top color"
- Step 6) Select edge finish"

Size  
Table top material  
Choose castors (C) or without castors (N)  
Base color  
Table top finish  
Edge finish  
Final Pattern No:

Base Table Square 28"  
Laminate  
Castors  
White base  
White  
Plywood  
MBTS282829LCWHITWHITPLY

MBTS282829  
L  
C  
WHIT  
WHIT  
PLY

Table Top Material	Base Color Options	Table Top Finish	Edge Finish Options
L - Laminate O - Linoleum V - Veneer N - Nanolaminate	WHIT - White BLCK - Black	Laminate WHIT - White BLCK - Black  Linoleum BLCK - Black  Veneer OAK - Oak  Nanolaminate WHIT - White BLCK - Black	PLY - Plywood (available for all All Variants) WHIT - White ABS (available with laminate only) BLCK - Black ABS (available with laminate only)

# BASE HIGH TABLE



Shipper Colli 2  
 Warranty Period 5 years for L440 cm, L300 cm, L440 cm and Ø128 cm variants.  
 10 years for all other variants

All dimensions of the Base High Table are identical, both with and without castors.

## All Variants

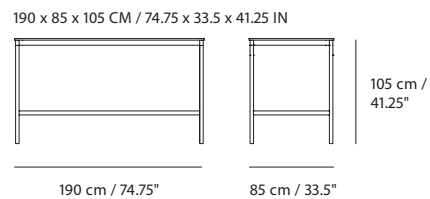
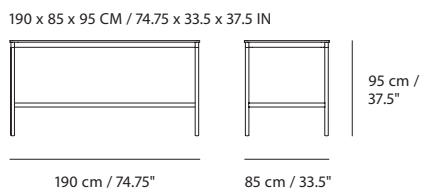
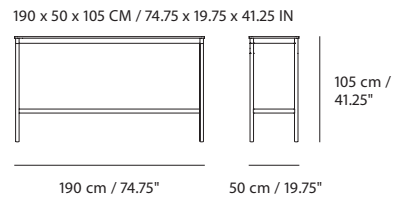
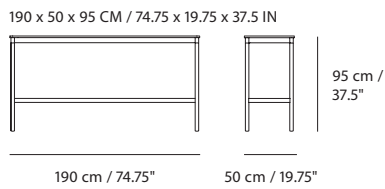
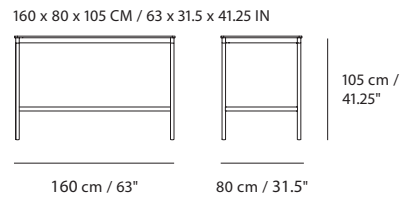
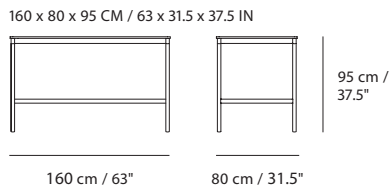
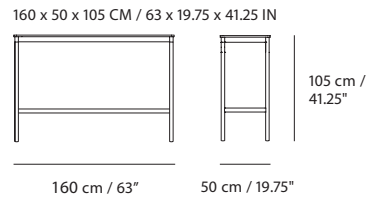
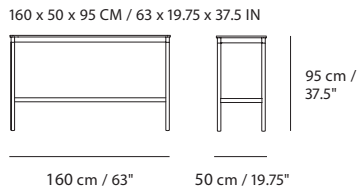

# BASE HIGH TABLE

## All Variants

Pattern No.	Width/ diameter rounded up	Depth	Height	Weight (kg)		Contract Price	Laminate (L) with ABS edge	Laminate (L) with plywood edge	Linoleum (O) with plywood edge	Oak Veneer (V) with plywood edge	Nanolami- nate (N) with plywood edge
M-BHTR-63-20-38	63"	19.75"	37.5"	32	without castors	2,571	2,571	2,886	3,040	3,145	
					with castors	2,781	2,781	3,096	3,145	3,355	
M-BHTR-63-20-41	63"	19.75"	41.25"	32.5	without castors	2,571	2,571	2,886	3,040	3,145	
					with castors	2,781	2,781	3,096	3,145	3,355	
M-BHTR-63-32-38	63"	31.5"	37.5"	32	without castors	2,571	2,571	2,886	3,040	3,145	
					with castors	2,781	2,781	3,096	3,145	3,355	
M-BHTR-63-32-41	63"	31.5"	41.25"	34	without castors	2,571	2,571	2,886	3,040	3,145	
					with castors	2,781	2,781	3,096	3,145	3,355	
M-BHTR-75-20-38	75"	19.75"	37.5"	34.5	without castors	2,676	2,676	3,040	3,355	3,565	
					with castors	2,886	2,886	3,145	3,565	3,831	
M-BHTR-75-20-41	75"	19.75"	41.25"	35	without castors	2,676	2,676	3,040	3,355	3,565	
					with castors	2,886	2,886	3,145	3,565	3,831	
M-BHTR-75-34-38	75"	33.5"	37.5"	40	without castors	2,676	2,676	3,040	3,145	3,355	
					with castors	2,886	2,886	3,145	3,565	3,565	
M-BHTR-75-34-41	75"	33.5"	41.25"	40.5	without castors	2,676	2,676	3,040	3,355	3,565	
					with castors	2,886	2,886	3,145	3,565	3,831	

### HOW TO CONFIGURE

#### Base Table

- Step 1) Select Size
- Step 2) Select table top material
- Step 3) Select castors (C) or without castors (N)
- Step 4) Select Frame color
- Step 5) Select Table top color
- Step 6) Select Edge finish

### ORDER CODE EXAMPLE

Base High Table Bar Height 63X19.7" in black linoleum and black frame

Size	Base High Table Bar Height Table 63X19.7"	MBHTR632041ON
Table top material	Linoleum	O
Choose castors (C) or without castors (N)	Without castors	N
Base color	Black	BLCK
Table top finish	Black	BLCK
Edge finish	Plywood	PLY
Final Pattern No:	MBHTR632041ONBLCKBLCKPLY	

Table Top Material	Base Color Options	Table Top Finish	Edge Finish Options
L - Laminate O - Linoleum V - Veneer N - Nanolaminate	WHIT - White BLCK - Black	Laminate WHIT - White BLCK - Black	PLY - Plywood (available for all All Variants) WHIT - White ABS (available with laminate only) BLCK - Black ABS (available with laminate only)
		Linoleum BLCK - Black	
		Veneer OAK - Oak	
		Nanolaminate WHIT - White BLCK - Black	

# COMPILE SHELVING SYSTEM

FOR MORE INFORMATION,  
EXPLORE BELOW

- ↗ [Product Fact Sheet](#)
- ↗ [Images](#)
- ↗ [Architect Files](#)
- ↗ [Assembly Instructions](#)
- ↗ [Product Declaration](#)

# COMPILE SHELVING SYSTEM / CONFIGURATION I

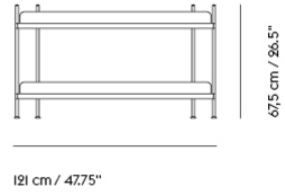

**Shipper Colli** 3  
**Gross Weight (kg)** 22.74  
**Net Weight (kg)** 18.27  
**Warranty Period** 10 years

Pattern No.	Color	Contract Price	Lead Time
<b>Ready-To-Ship EU Warehouse</b>			
MCOMSC1-BLCK	Black	USD 866.00	-
MCOMSC1-GREY	Grey	USD 866.00	-
MCOMSC1-WHIT	White	USD 866.00	-

# COMPILE SHELVING SYSTEM / CONFIGURATION 2

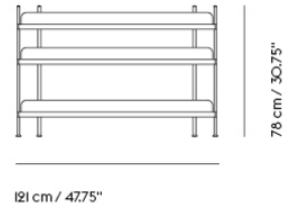

**Shipper Colli** 4  
**Gross Weight (kg)** 33.55  
**Net Weight (kg)** 27.11  
**Warranty Period** 10 years

Pattern No.	Color	Contract Price	Lead Time
<b>Ready-To-Ship EU Warehouse</b>			
MCOMSC2-BLCK	Black	USD 1,255.00	-
MCOMSC2-GREY	Grey	USD 1,255.00	-
MCOMSC2-WHIT	White	USD 1,255.00	-

# COMPILE SHELVING SYSTEM / CONFIGURATION 3



**Shipper Colli** 6  
**Gross Weight (kg)** 55.96  
**Net Weight (kg)** 45.49  
**Warranty Period** 10 years

Pattern No.	Color	Contract Price	Lead Time
<b>Ready-To-Ship EU Warehouse</b>			
MCOMSC3-BLCK	Black	USD 2,046.00	-
MCOMSC3-GREY	Grey	USD 2,046.00	-
MCOMSC3-WHIT	White	USD 2,046.00	-

# COMPILE SHELVING SYSTEM / CONFIGURATION 4

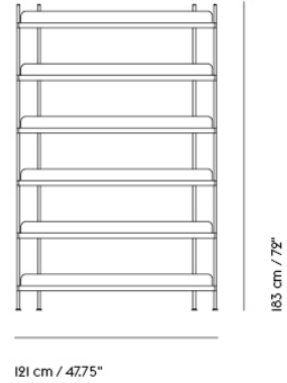

**Shipper Colli** 7  
**Gross Weight (kg)** 67.16  
**Net Weight (kg)** 54.69  
**Warranty Period** 10 years

Pattern No.	Color	Contract Price	Lead Time
<b>Ready-To-Ship EU Warehouse</b>			
MCOMSC4-BLCK	Black	USD 2,410.00	-
MCOMSC4-GREY	Grey	USD 2,410.00	-
MCOMSC4-WHIT	White	USD 2,410.00	-



# COMPILE SHELVING SYSTEM / CONFIGURATION 5

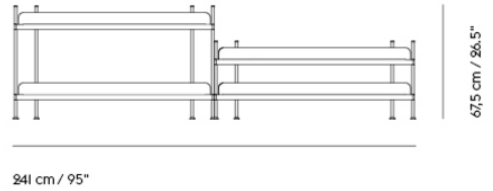

**Shipper Colli** 5  
**Gross Weight (kg)** 44.85  
**Net Weight (kg)** 36.24  
**Warranty Period** 10 years

Pattern No.	Color	Contract Price	Lead Time
<b>Ready-To-Ship EU Warehouse</b>			
MCOMSC5-BLCK	Black	USD 1,836.00	-
MCOMSC5-GREY	Grey	USD 1,836.00	-
MCOMSC5-WHIT	White	USD 1,836.00	-

# COMPILE SHELVING SYSTEM / CONFIGURATION 6

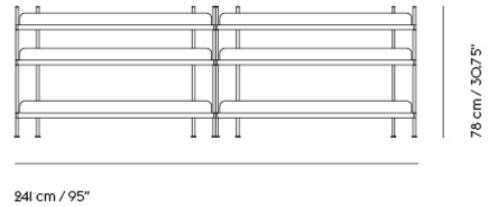

**Shipper Colli** 7  
**Gross Weight (kg)** 66.81  
**Net Weight (kg)** 54.21  
**Warranty Period** 10 years

Pattern No.	Color	Contract Price	Lead Time
<b>Ready-To-Ship EU Warehouse</b>			
MCOMSC6-BLCK	Black	USD 2,571.00	-
MCOMSC6-GREY	Grey	USD 2,571.00	-
MCOMSC6-WHIT	White	USD 2,571.00	-

# COMPILE SHELVING SYSTEM / CONFIGURATION 7

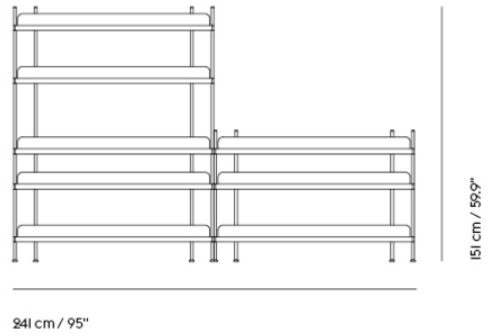

**Shipper Colli** 9  
**Gross Weight (kg)** 89.22  
**Net Weight (kg)** 72.6  
**Warranty Period** 10 years

Pattern No.	Color	Contract Price	Lead Time
<b>Ready-To-Ship EU Warehouse</b>			
MCOMSC7-BLCK	Black	USD 3,516.00	-
MCOMSC7-GREY	Grey	USD 3,516.00	-
MCOMSC7-WHIT	White	USD 3,516.00	-

# COMPILE SHELVING SYSTEM / CONFIGURATION 8

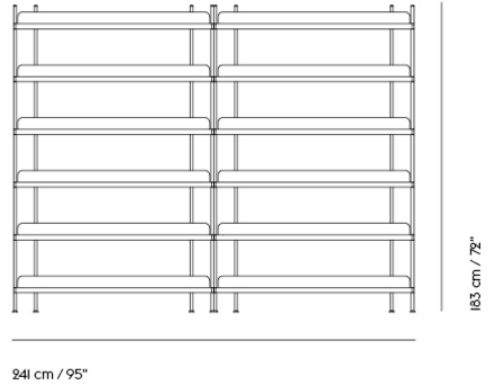

**Shipper Colli** 13  
**Gross Weight (kg)** 134.03  
**Net Weight (kg)** 109.39  
**Warranty Period** 10 years

Pattern No.	Color	Contract Price	Lead Time
<b>Ready-To-Ship EU Warehouse</b>			
MCOMSC8-BLCK	Black	USD 4,881.00	-
MCOMSC8-GREY	Grey	USD 4,881.00	-
MCOMSC8-WHIT	White	USD 4,881.00	-

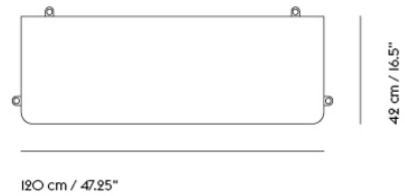

**Shipper Colli** 1  
**Gross Weight (kg)** 10.67  
**Net Weight (kg)** 8.7  
**Warranty period** 10 years

Pattern No.	Color	Contract Price	Lead Time
<b>Ready-To-Ship EU Warehouse</b>			
MCOMSH-BLCK	Black	USD 383.00	-
MCOMSH-GREY	Grey	USD 383.00	-
MCOMSH-WHIT	White	USD 383.00	-

# COMPILE SHELVING SYSTEM ESSENTIAL PACK

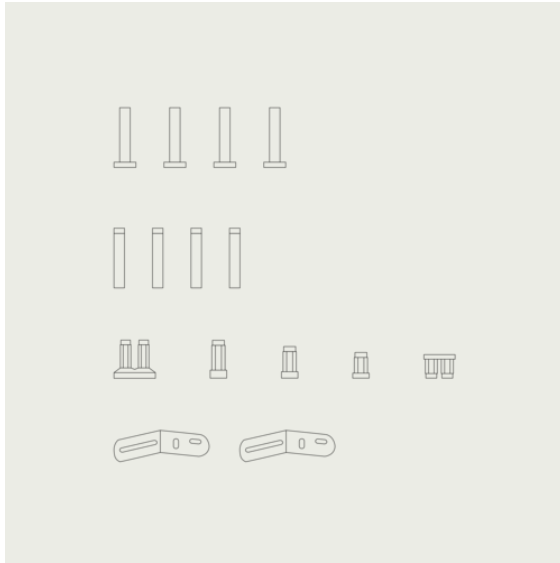

**Shipper Colli** 1  
**Gross Weight (kg)** 0.5  
**Net Weight (kg)** 0.3178  
**Warranty period** 10 years

Pattern No.	Color	Contract Price	Lead Time
<b>Ready-To-Ship EU Warehouse</b>			
MCOMEP-BLCK	Black	USD 146.00	-
MCOMEP-GREY	Grey	USD 146.00	-
MCOMEP-WHIT	White	USD 146.00	-

# COMPILE SHELVING SYSTEM DIVIDER PACK

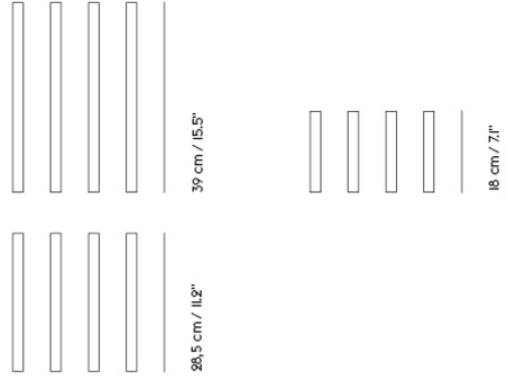
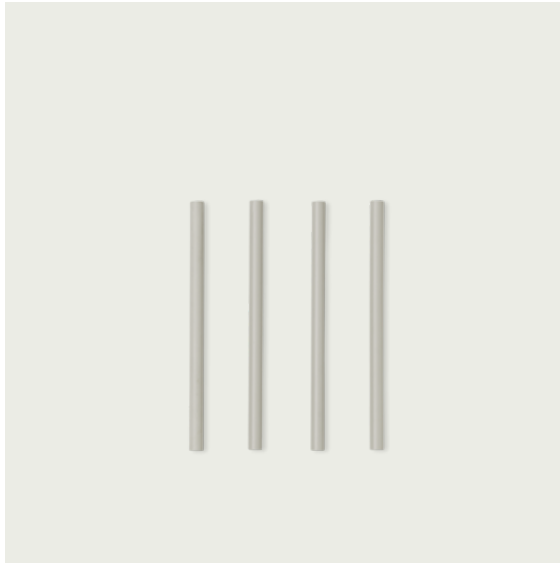

**Shipper Colli** 1  
**Gross Weight (kg)** 0.28  
**Net Weight (kg)** 0.253  
**Warranty period** 10 years

Pattern No.	Color	Contract Price	Lead Time
<b>Ready-To-Ship EU Warehouse</b>			
MCOMSDLG-BLCK	Black - Large	USD 58.00	-
MCOMSDMD-BLCK	Black - Medium	USD 58.00	-
MCOMSDSM-BLCK	Black - Small	USD 58.00	-
MCOMSDLG-GREY	Grey - Large	USD 58.00	-
MCOMSDMD-GREY	Grey - Medium	USD 58.00	-
MCOMSDSM-GREY	Grey - Small	USD 58.00	-
MCOMSDLG-WHIT	White - Large	USD 58.00	-
MCOMSDMD-WHIT	White - Medium	USD 58.00	-
MCOMSDSM-WHIT	White - Small	USD 58.00	-

# CONNECT MODULAR SOFA SERIES

FOR MORE INFORMATION,  
EXPLORE BELOW

- ↗ Product Fact Sheet
- ↗ Images
- ↗ Architect Files
- ↗ Assembly Instructions
- ↗ Product Declaration
- ↗ Product Planner



Designed with long, elegant lines, the Connect Modular Sofa's details of its small feet underneath for a hovering, light sentiment and pointy corners allow for the design to bring character to any space.

Create your own Connect Modular Sofa by choosing from 11 modules, following the guidelines below.

Visit [planner.muuto.com](http://planner.muuto.com) to create your own configuration online.

## Create your own Connect Configuration

### 1. SEATING MODULES

Select your desired seating modules.

Add the item numbers of the desired textile separately to your order.

**Note**

You can only connect seating modules with pre-mounted linking brackets on the sides, illustrated here with dotted lines. Please note that the modules H & I can only be used as a freestanding ottoman and not part of the sofa configuration.

#### END MODULES

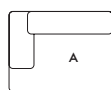

W 117 cm / 46"  
SW 88 cm / 34.6"

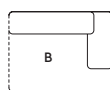

W 117 cm / 46"  
SW 88 cm / 34.6"

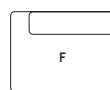

W 117 cm / 46"

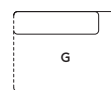

W 117 cm / 46"

D 92 cm / 36.2"  
SD 64 cm / 25.5"

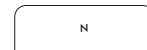

W 184 cm / 72.44"

D 67 cm / 26.38"  
SD 67 cm / 26.38"

#### END & LOUNGE MODULES

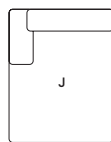

W 117 cm / 46"  
SW 88 cm / 34.6"

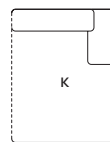

W 117 cm / 46"  
SW 88 cm / 34.6"

D 150 cm / 59"  
SD 122 cm / 48"

#### CENTER & CORNER MODULES

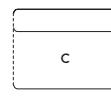

W 117 cm / 46"  
SW 88 cm / 34.6"

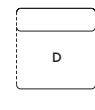

W 92 cm / 36.2"

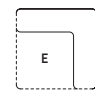

W 92 cm / 36.2"

D 92 cm / 36.2"

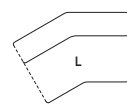

W 156 cm / 61.42"  
SW 134 cm / 52.76"

D 110 cm / 43.31"  
SD 64 cm / 25.2"

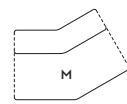

W 158 cm / 62.2"  
SW 134 cm / 52.76"

#### FREESTANDING MODULES

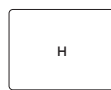

W 117 cm / 46"

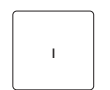

W 92 cm / 36.2"

D 92 cm / 36.2"

**Textile direction**

Corner Module E is designed to be used as corner. If used as End Module with armrest, the textile direction can differ. Modules connected on the left side of Corner Module E will have the same textile direction. The textile direction of modules connected on the right side will run into the opposite direction.

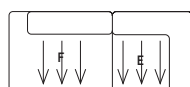

## INSPIRATION FOR YOUR CONFIGURATION

### 2-seater Configurations

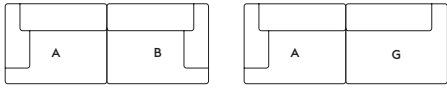

### 3-seater Configurations

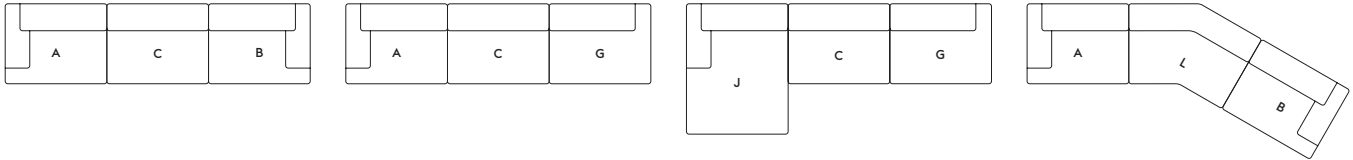

### 4-seater Configurations

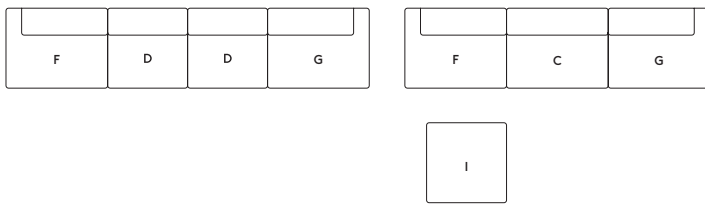

### Corner Configuration

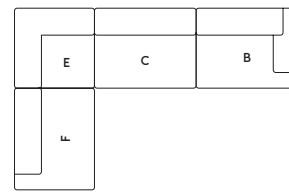

### Back-To-Back Configurations

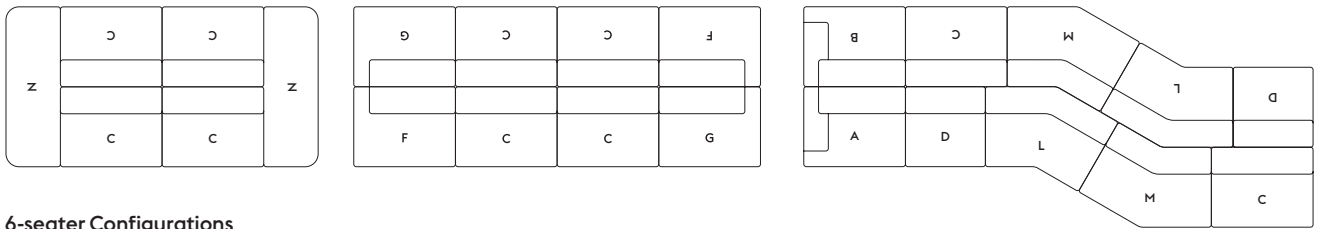

### 6-seater Configurations

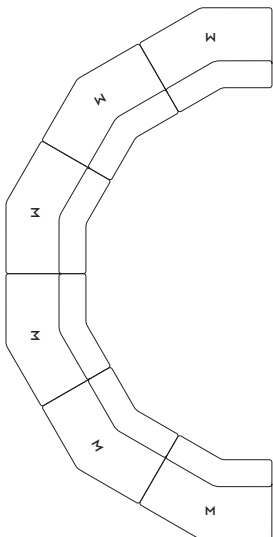

# CONNECT MODULAR SOFA / LEFT ARMREST (A)

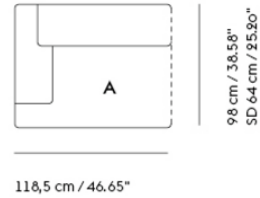

- Shipper Colli | 1
- Gross Weight (kg) | 55
- Net Weight (kg) | 50
- Please note | This product features an armrest on the left-hand side when facing the product from the front.
- Warranty Period | 10 years

Pattern No.	Color	Contract Price	Lead Time
<b>Ready-To-Ship US Warehouse</b>			
MCONAML-M156123	Remix I23 ***	USD 2,305.00	-
MCONAML-K207410	Aegean IO	USD 2,886.00	-

# CONNECT MODULAR SOFA / RIGHT ARMREST (B)

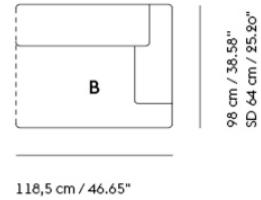

- Shipper Colli | 1
- Gross Weight (kg) | 55
- Net Weight (kg) | 50
- Please note | This product features an armrest on the right-hand side when facing the product from the front.
- Warranty Period | 10 years

Pattern No.	Color	Contract Price	Lead Time
<b>Ready-To-Ship US Warehouse</b>			
MCONAMR-M156123	Remix I23 ***	USD 2,305.00	-
MCONAMR-K207410	Aegean IO	USD 2,886.00	-

# CONNECT MODULAR SOFA / LONG CENTER (C)

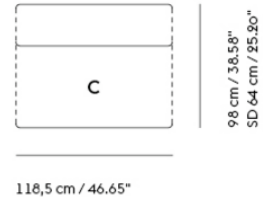

**Shipper Colli** | 1  
**Gross Weight (kg)** | 48  
**Net Weight (kg)** | 43  
**Warranty Period** | 10 years

Pattern No.	Color	Contract Price	Lead Time
<b>Ready-To-Ship US Warehouse</b>			
MCONCML-M156123	Remix I23 ***	USD 2,305.00	-
MCONCML-M14813	Vancouver I3 ***	USD 2,305.00	-
MCONCML-K207410	Aegean IO	USD 2,886.00	-

# CONNECT MODULAR SOFA / SHORT CENTER (D)

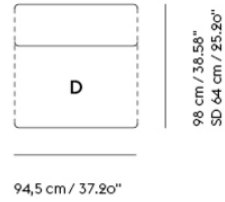

**Shipper Colli** | 1  
**Gross Weight (kg)** | 32  
**Net Weight (kg)** | 28  
**Warranty Period** | 10 years

Pattern No.	Color	Contract Price	Lead Time
<b>Ready-To-Ship US Warehouse</b>			
MCONCMS-M156123	Remix I23 ***	USD 2,046.00	-
MCONCMS-K207410	Aegean IO	USD 2,410.00	-

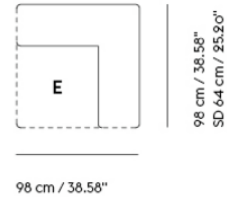

**Shipper Colli** 1  
**Gross Weight (kg)** 54  
**Net Weight (kg)** 50  
**Warranty Period** 10 years

Pattern No.	Color	Contract Price	Lead Time
<b>Ready-To-Ship US Warehouse</b>			
MCONC-M156123	Remix I23 ***	USD 2,305.00	-
MCONC-K207410	Aegean IO	USD 2,830.00	-

# CONNECT MODULAR SOFA / LEFT OPEN-ENDED (F)

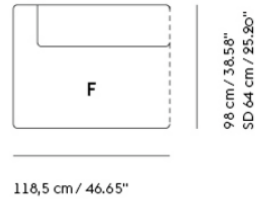

<b>Shipper Colli</b>	1
<b>Gross Weight (kg)</b>	47
<b>Net Weight (kg)</b>	42
<b>Please note</b>	This product features an open end on the left-hand side when facing the product from the front.
<b>Warranty Period</b>	10 years

Pattern No.	Color	Contract Price	Lead Time
<b>Ready-To-Ship US Warehouse</b>			
MCONOML-M156123	Remix I23 ***	USD 2,305.00	-
MCONOML-M14813	Vancouver I3 ***	USD 2,305.00	-
MCONOML-K207410	Aegean IO	USD 2,620.00	-



## CONNECT MODULAR SOFA / RIGHT OPEN-ENDED (G)

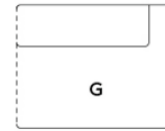

118,5 cm / 46.65"

98 cm / 38.58"  
SD 64 cm / 25.20"

Shipper Colli	1
Gross Weight (kg)	47
Net Weight (kg)	42
Please note	This product features an open end on the right-hand side when facing the product from the front.
Warranty Period	10 years

Pattern No.	Color	Contract Price	Lead Time
<b>Ready-To-Ship US Warehouse</b>			
MCONOMR-M156123	Remix I23	USD 2,305.00	-
MCONOMR-K207410	Aegean IO	USD 2,620.00	-

# CONNECT SOFA SERIES

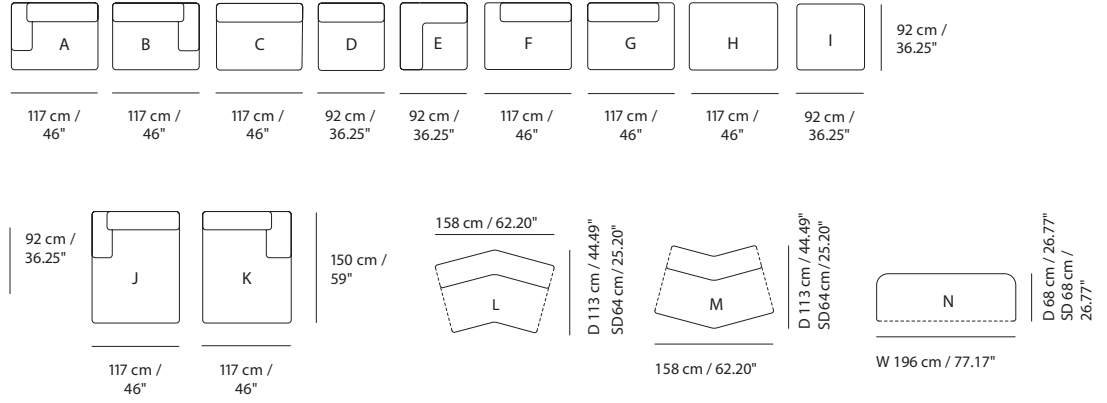

Shipper Colli 1  
 Directional Modules Right and left refers to the side when facing the product from the front.  
 Warranty Period 10 years

### All Variants

Modules	Pattern No.	Weight (kg)	Contract Price Upholstery Grades			
			A	B	C	E
Left Armrest (A)	M-CONAM-L	50	2,305	2,781	2,830	2,886
Right Armrest (B)	M-CONAM-R	50	2,305	2,781	2,830	2,886
Long Center (C)	M-CONCM-L	43	2,305	2,781	2,830	2,886
Short Center (D)	M-CONCM-S	28	2,046	2,256	2,361	2,410
Corner (E)	M-CONC	50	2,305	2,571	2,781	2,830
Left Open-ended (F)	M-CONOM-L	42	2,305	2,515	2,571	2,620
Right Open-Ended (G)	M-CONOM-R	42	2,305	2,515	2,571	2,620
Long Ottoman (H)	M-CONOTT-L	39	1,465	1,675	1,836	2,095
Short Ottoman (I)	M-CONOTT-S	27	1,416	1,570	1,731	1,836
Left Armrest Lounge (J)	M-CONLM-L	70	3,096	3,565	3,621	3,831
Right Armrest Lounge (K)	M-CONLM-R	70	3,096	3,565	3,621	3,831
Angle Module 150 degrees (L)	M-CONAN150	47	3,096	3,565	3,621	3,831
Angle Module 210 degrees (M)	M-CONAN210	44	3,096	3,565	3,621	3,831
End Module (N)	M-CONEND	31	2,305	2,781	2,830	2,886

### HOW TO CONFIGURE

### ORDER CODE EXAMPLE

Connect Sofa Connect sofa - A + D + B in Ocean 80

Specify:	Modules	Connect A + D + B	MCONAML MCONCMS MCONAMR
Step 1) Choose modules	Textile	Ocean	M161
Step 2) Choose Textile	Textile Color	80	80
Step 3) Choose Textile color	Final Pattern No.s (one per module)	MCONAMLM16180 MCONCMSM16180 MCONAMRM16180	

### Upholstery Options

A	B	C	E
Ocean (M161)* Remix (M156) Vancouver (M148) Wooly (M159)	Canvas (M153) Clara (M154) Fiord (M155) Grain (M12659) Manner (M12665) Steelcut (M149) Steelcut Quartet (M13042) Steelcut Trio (M139)	Hallingdal (M146)	Acca (M12660) Aegean (K2074) Beck (M6376) Clay (M2449)* Divina (M150) Divina MD (M147) Divina Melange (M135) Ecriture (M10767) Hearth (M12664) Twill Weave (M142) Vidar (M158)

\*Notes:  
 Ocean: Color 3, 21, 32, 50, 52, 80 & 601  
 Clay - Color 1, 2, 3, 4, 5, 6, 7, 8, 9, 10, 11, 12, 13, 14, 15, 16 & 17

# CONNECT SOFT MODULAR SOFA SERIES

FOR MORE INFORMATION,  
EXPLORE BELOW

- ↗ [Product Fact Sheet](#)
- ↗ [Images](#)
- ↗ [Architect Files](#)
- ↗ [Assembly Instructions](#)
- ↗ [Product Declaration](#)
- ↗ [Product Planner](#)

The Connect Soft Modular Sofa brings together elegantly slender proportions with a deeply inviting and ultra-soft comfort. Being at the heart of any space, its modularity allows for its user to tailor the design to their exact taste and space.

Choose between 9 predesigned configurations or create your own choosing from 9 seating modules and optional cushions, following the guidelines below.

Visit [planner.muuto.com](http://planner.muuto.com) to create your own configuration online.

## Create your own Connect Soft Configuration

### 1. SEATING MODULES

Select your desired seating modules.  
Add the item numbers of the desired textile separately to your order.

**Note**  
You can only connect seating modules with pre-mounted linking brackets on the sides, illustrated here with dotted lines. Pouf Module I can either be connected to other modules with pre-mounted linking brackets or be used as a freestanding module.

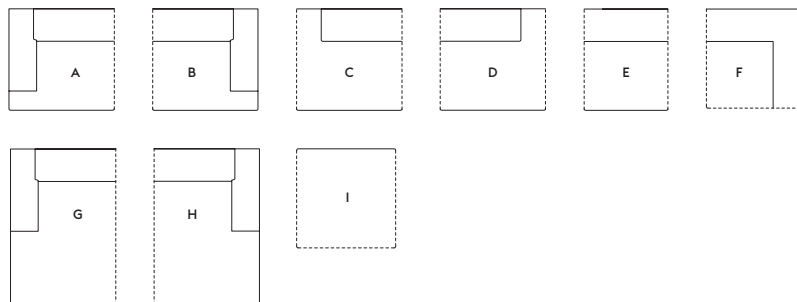

**Textile direction**  
Corner Module F is designed to be used as corner. If used as End Module with armrest, the textile direction can differ. Modules connected on the left side of Corner Module F will have the same textile direction. The textile direction of modules connected on the right side will run into the opposite direction.



### 2. CUSHIONS

Specify optional cushions in the desired textile for added comfort and a lounging expression.

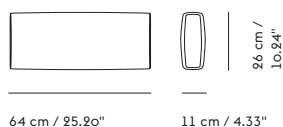

## INSPIRATION FOR YOUR CONFIGURATION

### 2-seater Configurations

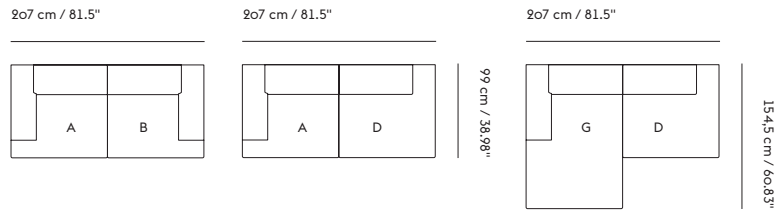

### 3-seater Configurations

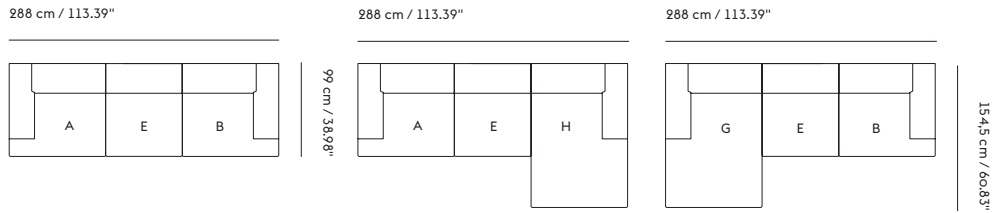

### Corner Configurations

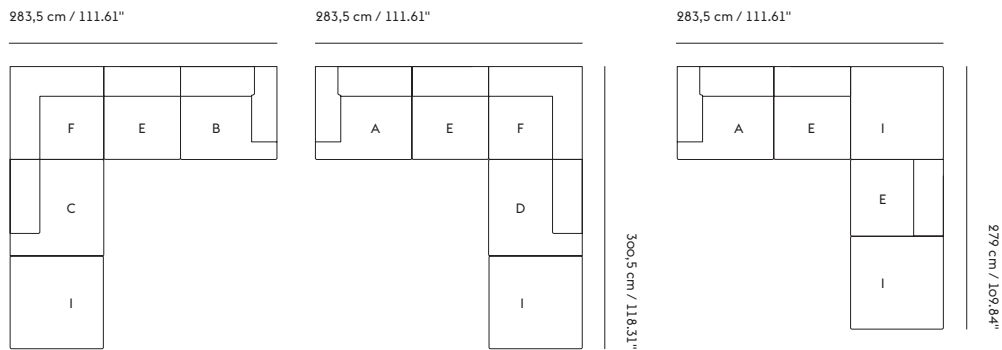

**General note**

The total dimensions of the configurations are indicative and can vary due to the inherent softness of the design and depending on how close the modules are placed as well as how many modules that are combined.

## CONNECT SOFT MODULAR SOFA / LEFT ARMREST (A)

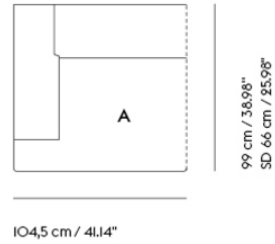

Shipper Colli	1
Gross Weight (kg)	50
Net Weight (kg)	38.3
Please note	This product features an armrest on the left-hand side when facing the product from the front.
Warranty Period	10 years

Pattern No.	Color	Contract Price	Lead Time
<b>Ready-To-Ship US Warehouse</b>			
MCONAMSL-M4586128	Re-wool 128 ***	USD 2,781.00	-
MCONAMSL-M244912	Clay 12	USD 2,886.00	-
<b>Extras</b>			
MLEAKIT	Leather care set for Refine Leather	USD 27.00	-

# CONNECT SOFT MODULAR SOFA / RIGHT ARMREST (B)



<b>Shipper Colli</b>	1
<b>Gross Weight (kg)</b>	50
<b>Net Weight (kg)</b>	38.3
<b>Please note</b>	This product features an armrest on the right-hand side when facing the product from the front
<b>Warranty Period</b>	10 years

Pattern No.	Color	Contract Price	Lead Time
-------------	-------	----------------	-----------

**Ready-To-Ship US Warehouse**

MCONAMSR-M4586128	Re-wool 128 ***	USD 2,781.00	-
MCONAMSR-M244912	Clay 12	USD 2,886.00	-

**Extras**

MLEAKIT	Leather care set for Refine Leather	USD 27.00	-
---------	-------------------------------------	-----------	---

## CONNECT SOFT MODULAR SOFA / LEFT OPEN-ENDED (C)

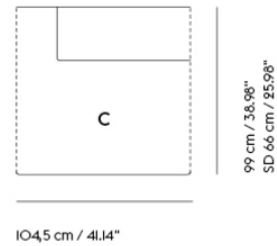

Shipper Colli	1
Gross Weight (kg)	46
Net Weight (kg)	34.3
Please note	This product features an open end on the left-hand side when facing the product from the front.
Warranty Period	10 years

Pattern No.	Color	Contract Price	Lead Time
<b>Ready-To-Ship US Warehouse</b>			
MCONOMSL-M4586128	Re-wool 128 ***	USD 2,515.00	-
MCONOMSL-M244912	Clay 12	USD 2,620.00	-
<b>Extras</b>			
MLEAKIT	Leather care set for Refine Leather	USD 27.00	-



# CONNECT SOFT MODULAR SOFA / RIGHT OPEN-ENDED (D)

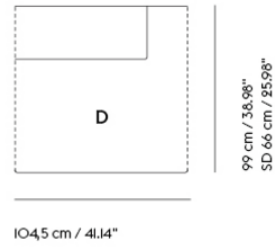

- Shipper Colli 1
- Gross Weight (kg) 46
- Net Weight (kg) 34.3
- Please note This product features an open end on the right-hand side when facing the product from the front.
- Warranty Period 10 years

Pattern No.	Color	Contract Price	Lead Time
<b>Ready-To-Ship US Warehouse</b>			
MCONOMSR-M4586128	Re-wool 128 ***	USD 2,515.00	-
MCONOMSR-M244912	Clay 12	USD 2,620.00	-
<b>Extras</b>			
MLEAKIT	Leather care set for Refine Leather	USD 27.00	-

# CONNECT SOFT MODULAR SOFA / CENTER (E)

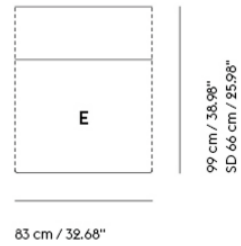

**Shipper Colli** | 1  
**Gross Weight (kg)** | 42  
**Net Weight (kg)** | 32.4  
**Warranty Period** | 10 years

Pattern No.	Color	Contract Price	Lead Time
<b>Ready-To-Ship US Warehouse</b>			
MCONCMSS-M4586128	Re-wool I28 ***	USD 2,956.00	-
MCONCMSS-M244912	Clay I2	USD 2,515.00	-
<b>Extras</b>			
MLEAKIT	Leather care set for Refine Leather	USD 27.00	-

# CONNECT SOFT MODULAR SOFA / CORNER (F)

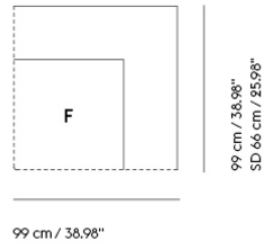

**Shipper Colli** |  
**Gross Weight (kg)** 50.8  
**Net Weight (kg)** 39.3  
**Warranty Period** 10 years

Pattern No.	Color	Contract Price	Lead Time
<b>Ready-To-Ship US Warehouse</b>			
MCONCS-M4586128	Re-wool 128 ***	USD 2,571.00	-
MCONCS-M244912	Clay 12	USD 2,886.00	-
<b>Extras</b>			
MLEAKIT	Leather care set for Refine Leather	USD 27.00	-

# CONNECT SOFT MODULAR SOFA / LEFT ARMREST CHAISE LOUNGE (G)

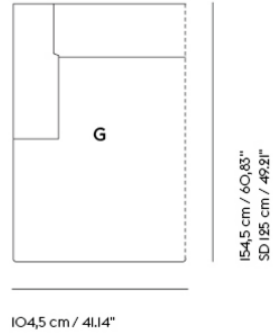

<b>Shipper Colli</b>	1
<b>Gross Weight (kg)</b>	67.2
<b>Net Weight (kg)</b>	52.1
<b>Please note</b>	This product features an armrest on the left-hand side when facing the product from the front.
<b>Warranty Period</b>	10 years

Pattern No.	Color	Contract Price	Lead Time
<b>Ready-To-Ship US Warehouse</b>			
MCONLMSL-M4586128	Re-wool I28/Black	USD 3,565.00	-
MCONLMSL-M244912	Clay I2/Black	USD 3,880.00	-
<b>Extras</b>			
MLEAKIT	Leather care set for Refine Leather	USD 27.00	-

# CONNECT SOFT MODULAR SOFA / RIGHT ARMREST CHAISE LOUNGE (H)

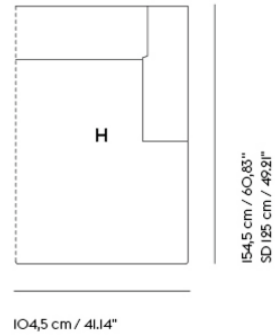

Shipper Colli	1
Gross Weight (kg)	67,2
Net Weight (kg)	52,1
Please note	This product features an armrest on the right-hand side when facing the product from the front.
Warranty Period	10 years

Pattern No.	Color	Contract Price	Lead Time
<b>Ready-To-Ship US Warehouse</b>			
MCONLMSR-M4586128	Re-wool I28/Black	USD 3,565.00	-
MCONLMSR-M244912	Clay I2/Black	USD 3,880.00	-
<b>Extras</b>			
MLEAKIT	Leather care set for Refine Leather	USD 27.00	-

# CONNECT SOFT MODULAR SOFA / OTTOMAN (I)

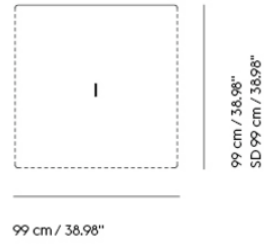

**Shipper Colli** I  
**Gross Weight (kg)** 35.29  
**Net Weight (kg)** 25.69  
**Warranty Period** 10 years

Pattern No.	Color	Contract Price	Lead Time
<b>Ready-To-Ship US Warehouse</b>			
MCONOTTSS-M4586128	Re-wool I28 ***	USD 1,836.00	-
MCONOTTSS-M244912	Clay I2	USD 2,095.00	-
<b>Extras</b>			
MLEAKIT	Leather care set for Refine Leather	USD 27.00	-

# CONNECT SOFT MODULAR SOFA / 2-SEATER - CONFIGURATION I

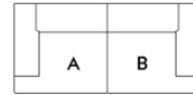

207 cm / 81.5"

99 cm / 38.98"  
SD 66 cm / 25.98"

Shipper Colli 2  
Gross Weight (kg) 100  
Net Weight (kg) 76.6  
Warranty Period 10 years

Pattern No.	Color	Contract Price	Lead Time
<b>Ready-To-Ship US Warehouse</b>			
MCONSPS2C1-M4586128	Re-wool I28	USD 5,406.00	-
MCONSPS2C1-M244912	Clay I2	USD 5,770.00	-

# CONNECT SOFT MODULAR SOFA / 2-SEATER - CONFIGURATION 2

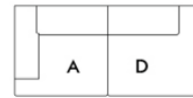

99 cm / 38.98"  
SD 66 cm / 25.98"

207 cm / 81.5"

Shipper Colli 2  
Gross Weight (kg) 96  
Net Weight (kg) 72.6  
Warranty Period 10 years

Pattern No.	Color	Contract Price	Lead Time
<b>Ready-To-Ship US Warehouse</b>			
MCONSPS2C2-M4586128	Re-wool I28	USD 5,140.00	-
MCONSPS2C2-M244912	Clay I2	USD 5,511.00	-



# CONNECT SOFT MODULAR SOFA / 2-SEATER - CONFIGURATION 3

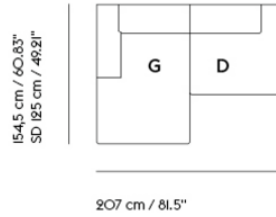

**Shipper Colli** 2  
**Gross Weight (kg)** 113.2  
**Net Weight (kg)** 86.4  
**Warranty Period** 10 years

Pattern No.	Color	Contract Price	Lead Time
<b>Ready-To-Ship US Warehouse</b>			
MCONSPS2C3-M4586128	Re-wool 128	USD 5,875.00	-
MCONSPS2C3-M244912	Clay 12	USD 6,505.00	-

# CONNECT SOFT MODULAR SOFA / 3-SEATER - CONFIGURATION I



99 cm / 38.98"  
SD 66 cm / 25.98"

288 cm / 113.39"

Shipper Colli 3  
Gross Weight (kg) 142  
Net Weight (kg) 109  
Warranty Period 10 years

Pattern No.	Color	Contract Price	Lead Time
<b>Ready-To-Ship US Warehouse</b>			
MCONSPS3C1-M4586128	Re-wool I28	USD 7,506.00	-
MCONSPS3C1-M244912	Clay I2	USD 8,241.00	-

# CONNECT SOFT MODULAR SOFA / 3-SEATER - CONFIGURATION 2

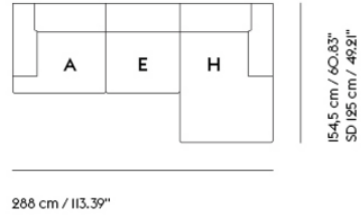

**Shipper Colli** 3  
**Gross Weight (kg)** 159.2  
**Net Weight (kg)** 122.8  
**Warranty Period** 10 years

Pattern No.	Color	Contract Price	Lead Time
<b>Ready-To-Ship US Warehouse</b>			
MCONSPS3C2-M4586128	Re-wool 128	USD 8,290.00	-
MCONSPS3C2-M244912	Clay 12	USD 9,081.00	-

# CONNECT SOFT MODULAR SOFA / 3-SEATER - CONFIGURATION 3

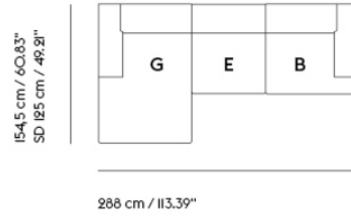

Shipper Colli 3  
 Gross Weight (kg) 159.2  
 Net Weight (kg) 122.8  
 Warranty Period 10 years

Pattern No.	Color	Contract Price	Lead Time
<b>Ready-To-Ship US Warehouse</b>			
MCONSPS3C3-M4586128	Re-wool 128	USD 8,290.00	-
MCONSPS3C3-M244912	Clay 12	USD 9,081.00	-

# CONNECT SOFT MODULAR SOFA / CORNER - CONFIGURATION I

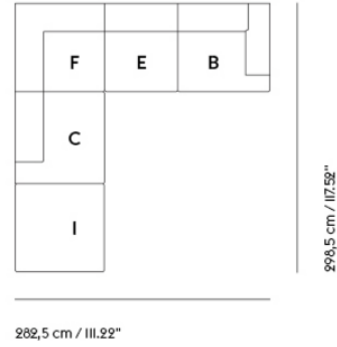

Shipper Colli 5  
 Gross Weight (kg) 224.09  
 Net Weight (kg) 169.99  
 Warranty Period 10 years

Pattern No.	Color	Contract Price	Lead Time
<b>Ready-To-Ship US Warehouse</b>			
MCONSPSCC1-M4586128	Re-wool I28	USD 11,545.00	-
MCONSPSCC1-M244912	Clay I2	USD 13,120.00	-

# CONNECT SOFT MODULAR SOFA / CORNER - CONFIGURATION 2

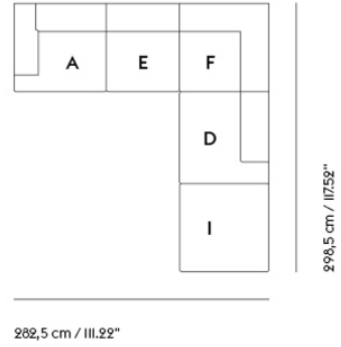

**Shipper Colli** 5  
**Gross Weight (kg)** 224.09  
**Net Weight (kg)** 169.99  
**Warranty Period** 10 years

Pattern No.	Color	Contract Price	Lead Time
<b>Ready-To-Ship US Warehouse</b>			
MCONSPSCC2-M4586128	Re-wool 128	USD 11,545.00	-
MCONSPSCC2-M244912	Clay 12	USD 13,120.00	-

# CONNECT SOFT MODULAR SOFA / CORNER - CONFIGURATION 3

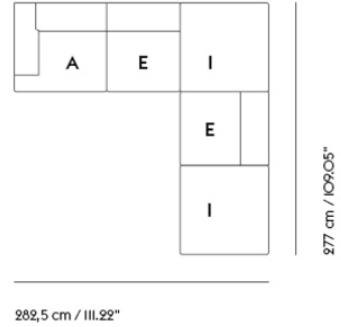

**Shipper Colli** 5  
**Gross Weight (kg)** 204.58  
**Net Weight (kg)** 154.48  
**Warranty Period** 10 years

Pattern No.	Color	Contract Price	Lead Time
<b>Ready-To-Ship US Warehouse</b>			
MCONSPSCC3-M4586128	Re-wool I28	USD 10,390.00	-
MCONSPSCC3-M244912	Clay I2	USD 12,070.00	-

# CONNECT SOFT MODULAR SOFA CUSHION



**Shipper Colli** 1  
**Gross Weight (kg)** 1.3  
**Net Weight (kg)** 0.1  
**Warranty Period** 5 Years

Pattern No.	Color	Contract Price	Lead Time
<b>Ready-To-Ship US Warehouse</b>			
MCONSCUS2510-M4586128	Re-wool I28 ***	USD 257.00	-
MCONSCUS2510-M244912	Clay I2	USD 289.00	-
<b>Extras</b>			
MLEAKIT	Leather care set for Refine Leather	USD 27.00	-



# CONNECT SOFT MODULAR SOFA SERIES

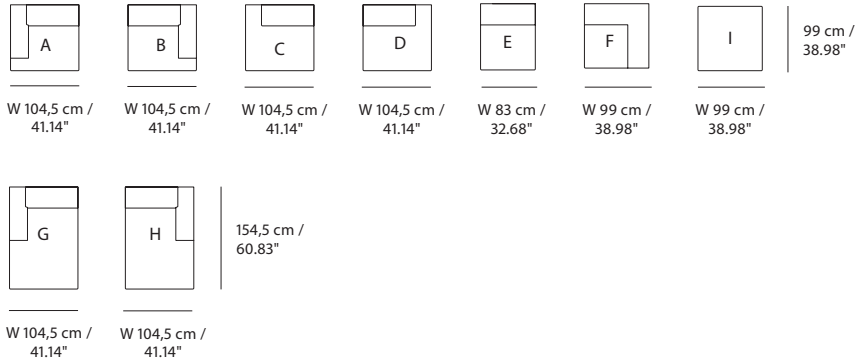

Shipper Colli 1  
 Directional Modules Right and left refers to the side when facing the product from the front.  
 Warranty Period 10 years

## All Variants

Modules	Pattern No.	Weight (kg)	Contract Price Upholstery Grades									
			A	B	C	E	R	T	U	V	W	
Left Armrest (A)	M-CONAMS-L	39	2,305	2,781	2,830	2,886	3,565	4,356	4,671	5,301	5,826	
Right Armrest (B)	M-CONAMS-R	39	2,305	2,781	2,830	2,886	3,565	4,356	4,671	5,301	5,826	
Center (E)	M-CONCMSS	33	2,046	2,256	2,361	2,515	2,830	3,411	3,726	4,146	4,615	
Corner (F)	M-CONCS	40	2,305	2,571	2,781	2,886	3,565	4,356	4,671	5,301	5,826	
Left Open-ended (C)	M-CONOMS-L	35	2,305	2,515	2,571	2,620	3,306	3,985	4,251	4,881	5,301	
Right Open-Ended (D)	M-CONOMS-R	35	2,305	2,515	2,571	2,620	3,306	3,985	4,251	4,881	5,301	
Ottoman (I)	M-CONOTTSS	26	1,570	1,731	2,046	2,095	2,515	2,886	3,096	3,565	3,880	
Left Armrest Lounge (G)	M-CONLMS-L	53	3,096	3,565	3,621	3,880	4,615	5,560	6,036	6,820	7,450	
Right Armrest Lounge (H)	M-CONLMS-R	53	3,096	3,565	3,621	3,880	4,615	5,560	6,036	6,820	7,450	
Cushion	MCONSCUS-2510		198	257	278	289	268	362	394	450	503	

## HOW TO CONFIGURE

## ORDER CODE EXAMPLE

Connect Soft Sofa Specify:	Connect soft sofa - A + D + B in Re-Wool 128 Modules	Connect A + D + B
Step 1) Choose modules	Textile	Re-Wool
Step 2) Choose Textile	Textile Color	128
Step 3) Choose Textile color	Final Pattern No.s (one per module)	M4586 128 MCONAMSL-M4586128 MCONOMS-R-M4586128 MCONAMSR-M4586128

## Upholstery Options

A	B	C	E	R	T	U	V	W
Ocean (M161)* Remix (M156) Vancouver (M148)	Canvas (M153) Clara (M154) Fiord (M155) Grain (M12659) Manner (M12665) Re-Wool (M4586) Sabi (M8404) Steelcut (M149) Steelcut Trio (M139)	Hallingdal (M146)	Acca (M12660) Beck (M6376) Divina (M150) Divina MD (M147) Divina Melange (M135) Ecriture (M10767) Hearth (M12664) Twill Weave (M142) Vidar (M158)	Easy Leather (M141)	Refine Leather (M136)	Endure Leather (M137)	Grace Leather (M12374)	Allure Leather (M12375)

\*Notes:  
 Ocean: Color 3, 21, 32, 50, 52, 80 & 601  
 Clay - Color 1, 2, 3, 4, 5, 6, 7, 8, 9, 10, 11, 12, 13, 14, 15, 16 & 17

# COUPLE COFFEE TABLE

FOR MORE INFORMATION,  
EXPLORE BELOW

- ↗ [Product Fact Sheet](#)
- ↗ [Images](#)
- ↗ [Architect Files](#)
- ↗ [Assembly Instructions](#)
- ↗ [Product Declaration](#)

The Couple Coffee Table Series consists of 3 wooden frame sizes and 2 types of ceramic stoneware tiles available in a selection of finishes. We have defined 36 variants for your convenience. Follow the steps below to find the one that suits your needs, and explore the 36 possible variants in the overview.

Visit [muuto.com/products/shop-by-family/couple-coffee-table](https://muuto.com/products/shop-by-family/couple-coffee-table) to get inspired and learn more about the design.

## 1. SIZE

Choose your preferred table size among three sizes.

120 x 84 x 35 cm

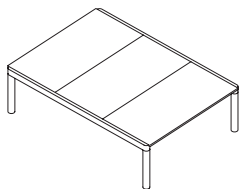

35 cm / 13.7"

120 cm / 47.2"    84 cm / 33.2"

80 x 84 x 40 cm

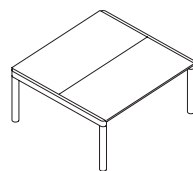

40 cm / 15.7"

80 cm / 31.5"    84 cm / 33.2"

40 x 84 x 40 cm

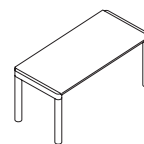

40 cm / 15.7"

40 cm    84 cm / 33.2" / 15.7"

## 2. TILE COMBINATIONS

Choose your preferred tabletop surface—with a fully plain surface or with a mix of Plain and Wavy tiles.

**Note**  
Please note that there is a maximum of one Wavy tile per table on the 120x84x35 cm and 80x84x40 cm variant.

### Tile Surfaces

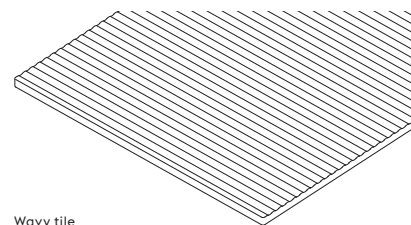
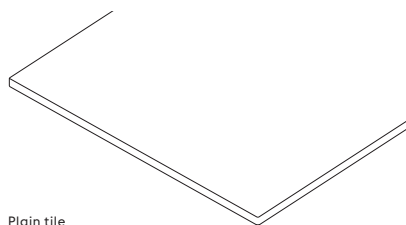

### Combinations

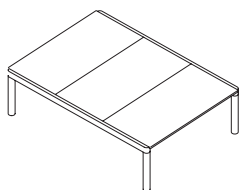

3 Plain

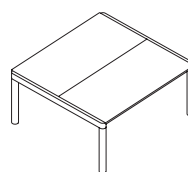

2 Plain

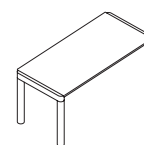

1 Plain

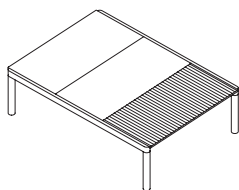

2 Plain 1 Wavy

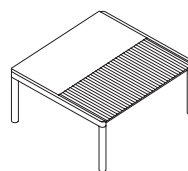

1 Plain 1 Wavy

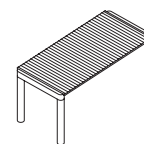

1 Wavy

## 3. FINISHES & COLORS

Select your preferred finish among 6 color combinations. Discover all 36 variants in the overview.

**Note**  
Please note that the tile colors cannot be mixed.

### Tabletop / Frame



Sand / Oak



Sand / Dark Oiled Oak



Pale Blue / Oak



Pale Blue / Dark Oiled Oak



Taupe / Oak



Taupe / Dark Oiled Oak



Sand /  
Oak

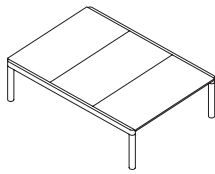

3 Plain

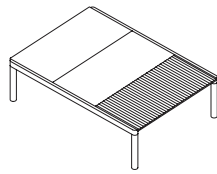

2 Plain 1 Wavy

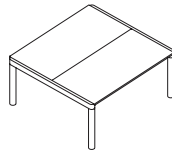

2 Plain

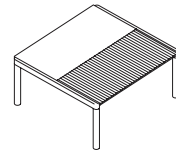

1 Plain 1 Wavy

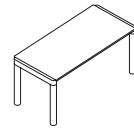

1 Plain



1 Wavy



Sand /  
Dark Oiled  
Oak

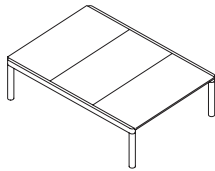

3 Plain

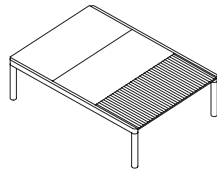

2 Plain 1 Wavy

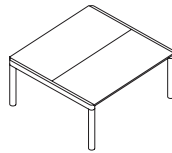

2 Plain

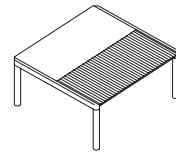

1 Plain 1 Wavy

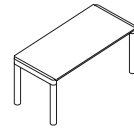

1 Plain



1 Wavy



Pale Blue /  
Oak

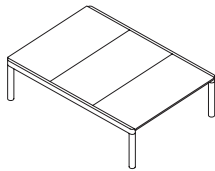

3 Plain

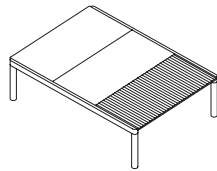

2 Plain 1 Wavy

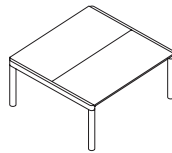

2 Plain

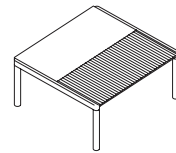

1 Plain 1 Wavy

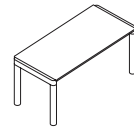

1 Plain

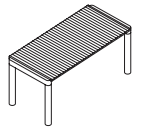

1 Wavy



Pale Blue /  
Dark Oiled  
Oak

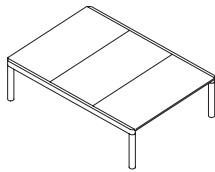

3 Plain

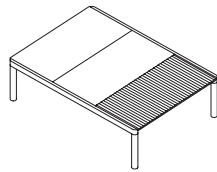

2 Plain 1 Wavy

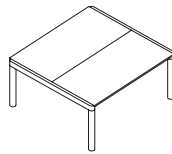

2 Plain

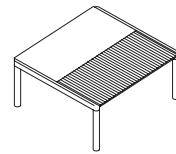

1 Plain 1 Wavy

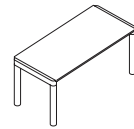

1 Plain

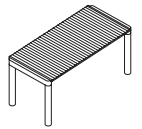

1 Wavy



Taupe /  
Oak

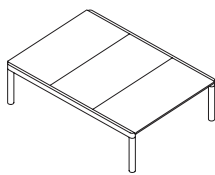

3 Plain

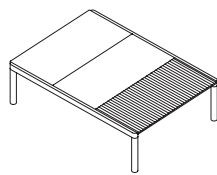

2 Plain 1 Wavy

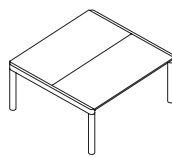

2 Plain

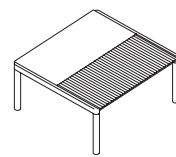

1 Plain 1 Wavy

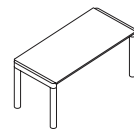

1 Plain



1 Wavy



Taupe /  
Dark Oiled  
Oak

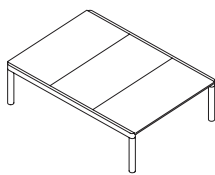

3 Plain

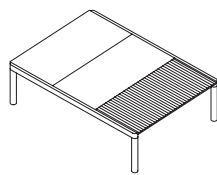

2 Plain 1 Wavy

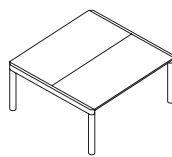

2 Plain

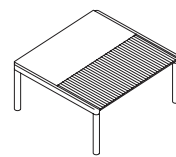

1 Plain 1 Wavy

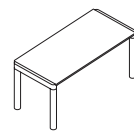

1 Plain

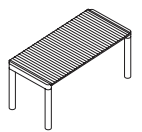

1 Wavy

**COUPLE COFFEE TABLE / 40 X 84 X 40  
CM / 15.7 X 33.2 X 15.7"**

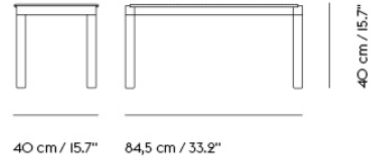

Shipper Colli 2  
 Gross Weight (kg) 16.24  
 Net Weight (kg) 13.86  
 Warranty 10 years

Pattern No.	Color	Contract Price	Lead Time
<b>Ready-To-Ship US Warehouse</b>			
MCOUP1PL-PABU-DOAK	1 Plain - Pale Blue/Dark Oiled Oak ***	USD 1,206.00	-
MCOUP1PL-PABU-OAK	1 Plain - Pale Blue/Oak ***	USD 1,206.00	-
MCOUP1PL-SAND-DOAK	1 Plain - Sand/Dark Oiled Oak	USD 1,206.00	-
MCOUP1PL-SAND-OAK	1 Plain - Sand/Oak	USD 1,206.00	-
MCOUP1PL-TAUP-DOAK	1 Plain - Taupe/Dark Oiled Oak	USD 1,206.00	-
MCOUP1PL-TAUP-OAK	1 Plain - Taupe/Oak	USD 1,206.00	-
MCOUP1WV-LTBU-DOAK	1 Wavy - Light Blue/Dark Oiled Oak	USD 1,206.00	-
MCOUP1WV-LTBU-OAK	1 Wavy - Light Blue/Oak	USD 1,206.00	-
MCOUP1WV-SAND-DOAK	1 Wavy - Sand/Dark Oiled Oak	USD 1,206.00	-
MCOUP1WV-SAND-OAK	1 Wavy - Sand/Oak	USD 1,206.00	-
MCOUP1WV-TAUP-DOAK	1 Wavy - Taupe/Dark Oiled Oak	USD 1,206.00	-
MCOUP1WV-TAUP-OAK	1 Wavy - Taupe/Oak	USD 1,206.00	-

# COUPLE COFFEE TABLE / 80 X 84 X 40 CM / 31.5 X 33.2 X 15.7"

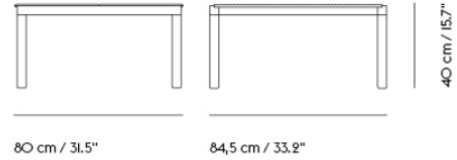

Shipper Colli	3
Gross Weight (kg)	29.78
Net Weight (kg)	25.52
Warranty	10 years

Pattern No.	Color	Contract Price	Lead Time
<b>Ready-To-Ship US Warehouse</b>			
MCOUP2PW-LTBU-DOAK	1 Plain 1 Wavy - Light Blue/Dark Oiled Oak	USD 1,626.00	-
MCOUP2PW-LTBU-OAK	1 Plain 1 Wavy - Light Blue/Oak	USD 1,626.00	-
MCOUP2PW-SAND-DOAK	1 Plain 1 Wavy - Sand/Dark Oiled Oak	USD 1,626.00	-
MCOUP2PW-SAND-OAK	1 Plain 1 Wavy - Sand/Oak	USD 1,626.00	-
MCOUP2PW-TAUP-DOAK	1 Plain 1 Wavy - Taupe/Dark Oiled Oak	USD 1,626.00	-
MCOUP2PW-TAUP-OAK	1 Plain 1 Wavy - Taupe/Oak	USD 1,626.00	-
MCOUP2PL-PABU-DOAK	2 Plain - Pale Blue/Dark Oiled Oak ***	USD 1,626.00	-
MCOUP2PL-PABU-OAK	2 Plain - Pale Blue/Oak ***	USD 1,626.00	-
MCOUP2PL-SAND-DOAK	2 Plain - Sand/Dark Oiled Oak	USD 1,626.00	-
MCOUP2PL-SAND-OAK	2 Plain - Sand/Oak	USD 1,626.00	-
MCOUP2PL-TAUP-DOAK	2 Plain - Taupe/Dark Oiled Oak	USD 1,626.00	-
MCOUP2PL-TAUP-OAK	2 Plain - Taupe/Oak	USD 1,626.00	-

# COUPLE COFFEE TABLE / 120 X 84 X 35 CM / 47.2 X 33.2 X 13.7"

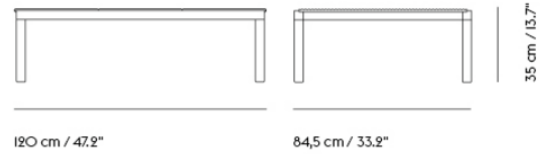

Shipper Colli	4
Gross Weight (kg)	42.42
Net Weight (kg)	36.28
Warranty	10 years

Pattern No.	Color	Contract Price	Lead Time
<b>Ready-To-Ship US Warehouse</b>			
MCOUP3PW-LTBU-DOAK	2 Plain   Wavy - Light Blue/Dark Oiled Oak	USD 2,151.00	-
MCOUP3PW-LTBU-OAK	2 Plain   Wavy - Light Blue/Oak	USD 2,151.00	-
MCOUP3PW-SAND-DOAK	2 Plain   Wavy - Sand/Dark Oiled Oak	USD 2,151.00	-
MCOUP3PW-SAND-OAK	2 Plain   Wavy - Sand/Oak	USD 2,151.00	-
MCOUP3PW-TAUP-DOAK	2 Plain   Wavy - Taupe/Dark Oiled Oak	USD 2,151.00	-
MCOUP3PW-TAUP-OAK	2 Plain   Wavy - Taupe/Oak	USD 2,151.00	-
MCOUP3PL-PABU-DOAK	3 Plain - Pale Blue/Dark Oiled Oak ***	USD 2,151.00	-
MCOUP3PL-PABU-OAK	3 Plain - Pale Blue/Oak ***	USD 2,151.00	-
MCOUP3PL-SAND-DOAK	3 Plain - Sand/Dark Oiled Oak	USD 2,151.00	-
MCOUP3PL-SAND-OAK	3 Plain - Sand/Oak	USD 2,151.00	-
MCOUP3PL-TAUP-DOAK	3 Plain - Taupe/Dark Oiled Oak	USD 2,151.00	-
MCOUP3PL-TAUP-OAK	3 Plain - Taupe/Oak	USD 2,151.00	-

# COVER CHAIR SERIES

FOR MORE INFORMATION,  
EXPLORE BELOW

- ↗ [Product Fact Sheet](#)
- ↗ [Images](#)
- ↗ [Architect Files](#)
- ↗ [Assembly Instructions](#)
- ↗ [Product Declaration](#)
- ↗ [Product Configurator](#)



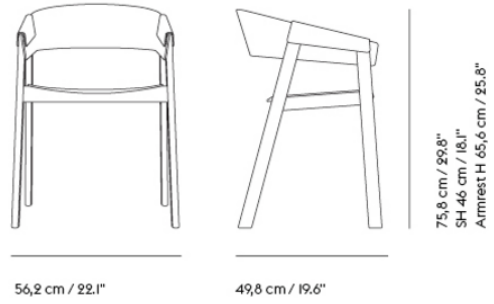

<b>Shipper Colli</b>	1
<b>Gross Weight (kg)</b>	6.9
<b>Net Weight (kg)</b>	5
<b>Base color options</b>	Black, Dark Beige, Green, Oak or Stained Dark Brown
<b>Warranty Period</b>	10 years

Pattern No.	Color	Contract Price	Lead Time
<b>Ready-To-Ship US Warehouse</b>			
MCVRAW-BLCK	Black	USD 667.00	-
MCVRAW-DKBE	Dark Beige	USD 667.00	-
MCVRAW-OAK	Oak	USD 667.00	-
MCVRAW-STDB	Stained Dark Brown	USD 667.00	-
MCVRAU-BLCK-M136BLCK	Refine Leather Black/Black	USD 933.00	-
MCVRAU-OAK-M136COGN	Refine Leather Cognac/Oak	USD 933.00	-
MCVRAU-DKBE-M136STON	Refine Leather Stone/Dark Beige ***	USD 933.00	-

<b>Ready-To-Ship EU Warehouse</b>			
MCVRAW-GREN	Green	USD 667.00	-

<b>Extras</b>			
MGLDCVSFT4	Felt Glides for the Cover Series (4 pcs per pack) - White	USD 21.00	-
MGLDCVSPT4	Plastic glides for the Cover Series (4 pcs per pack) - White	USD 21.00	-
MLEAKIT	Leather care set for Refine Leather	USD 27.00	-

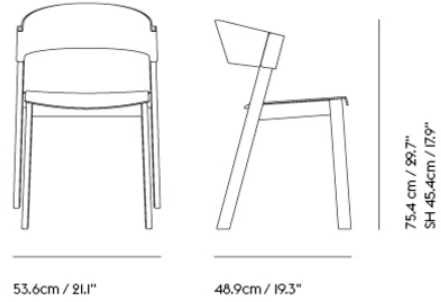

<b>Shipper Colli</b>	1
<b>Gross Weight (kg)</b>	10.3
<b>Net Weight (kg)</b>	4.2
<b>Base color options</b>	Black, Dark Beige, Green, Oak or Stained Dark Brown
<b>Stacking information</b>	Cover Side Chair stacks up to 4 chairs on floor and 10 chairs on the Cover Transport Trolley.
<b>Warranty Period</b>	10 years

Pattern No.	Color	Contract Price	Lead Time
<b>Ready-To-Ship US Warehouse</b>			
MCVRSW-BLCK	Black	USD 667.00	-
MCVRSW-DKBE	Dark Beige	USD 667.00	-
MCVRSW-OAK	Oak	USD 667.00	-
MCVRSW-STDB	Stained Dark Brown	USD 667.00	-
MCVRSU-BLCK-M136BLCK	Refine Leather Black/Black	USD 933.00	-
MCVRSU-STDB-M136BLCK	Refine Leather Black/Stained Dark Brown	USD 933.00	-
MCVRSU-OAK-M136COGN	Refine Leather Cognac/Oak	USD 933.00	-
MCVRSU-DKBE-M136STON	Refine Leather Stone/Dark Beige	USD 933.00	-
<b>Ready-To-Ship EU Warehouse</b>			
MCVRSW-GREN	Green	USD 667.00	-
<b>Extras</b>			
MGLDCVSFT4	Felt Glides for the Cover Series (4 pcs per pack) - White	USD 21.00	-
MGLDCVSPT4	Plastic glides for the Cover Series (4 pcs per pack) - White	USD 21.00	-
MLEAKIT	Leather care set for Refine Leather	USD 27.00	-

# COVER AND VISU CHAIR TRANSPORT TROLLEY

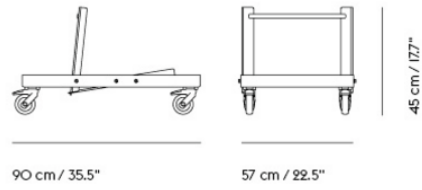

<b>Shipper Colli</b>	1
<b>Gross Weight (kg)</b>	22
<b>Net Weight (kg)</b>	21.5
<b>Please note</b>	This transport trolley can be used for Visu Chair Tube Base, Visu Chair Sled Base and Cover Side Chair.
<b>Stacking information</b>	Cover Side Chair (10 pcs.) / Visu Chair Sled Base (17 pcs.) / Visu Chair Tube Base (17 pcs.) / Visu Chair Sled Base w. Upholstery (15 pcs.) / Visu Chair Tube Base w. Upholstery (15 pcs)
<b>Warranty Period</b>	5 years

Pattern No.	Color	Contract Price	Lead Time
<b>Ready-To-Ship US Warehouse</b>			
MTTCV	Black	USD 971.00	-

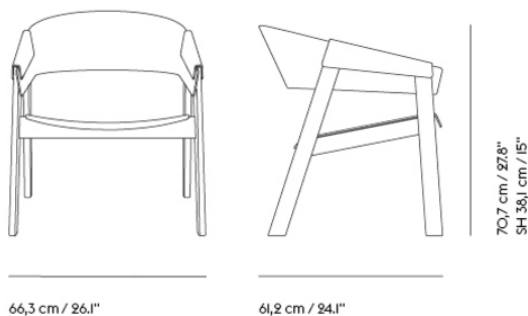

Shipper Colli	1
Gross Weight (kg)	9.423
Net Weight (kg)	7.5
Base color options	Black or Oak
Warranty Period	10 years

Pattern No.	Color	Contract Price	Lead Time
<b>Ready-To-Ship US Warehouse</b>			
MCVRLW-BLCK	Black - PU Lacquer ***	USD 1,206.00	-
MCVRLW-OAK	Oak - PU Lacquer	USD 1,206.00	-
MCVRLW-STDB	Stained Dark Brown	USD 1,206.00	-
MCVRLU-BLCK-M136BLCK	Refine Leather Black/Black	USD 1,675.00	-
MCVRLU-STDB-M136BLCK	Refine Leather Black/Stained Dark Brown	USD 1,675.00	-
MCVRLU-OAK-M136COGN	Refine Leather Cognac/Oak	USD 1,675.00	-
<b>Extras</b>			
MGLDCVSFT4	Felt Glides for the Cover Series (4 pcs per pack) - White	USD 21.00	-
MGLDCVSP4	Plastic glides for the Cover Series (4 pcs per pack) - White	USD 21.00	-
MLEAKIT	Leather care set for Refine Leather	USD 27.00	-

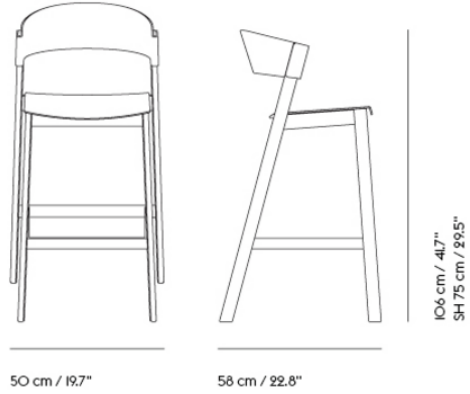

Shipper Colli	1
Gross Weight (kg)	9.15
Net Weight (kg)	6.25
Base color options	Black or Oak
Warranty Period	10 Years

Pattern No.	Color	Contract Price	Lead Time
-------------	-------	----------------	-----------

**Ready-To-Ship US Warehouse**

MCVRSTBW-BLCK	Black	USD 902.00	-
MCVRSTBW-OAK	Oak	USD 902.00	-
MCVRSTBW-STDB	Stained Dark Brown ***	USD 902.00	-
MCVRSTBU-BLCK-M136BLCK	Refine Leather Black/Black	USD 1,206.00	-
MCVRSTBU-OAK-M136COGN	Refine Leather Cognac/Oak	USD 1,206.00	-

**Ready-To-Ship EU Warehouse**

MCVRSTBW-GREN	Green	USD 902.00	-
---------------	-------	------------	---

**Extras**

MGLDCVSFT4	Felt Glides for the Cover Series (4 pcs per pack) - White	USD 21.00	-
MGLDCVSPT4	Plastic glides for the Cover Series (4 pcs per pack) - White	USD 21.00	-
MLEAKIT	Leather care set for Refine Leather	USD 27.00	-
MFTRSTC	Steel Footrest Protector - Self-Mounting	USD 39.00	-

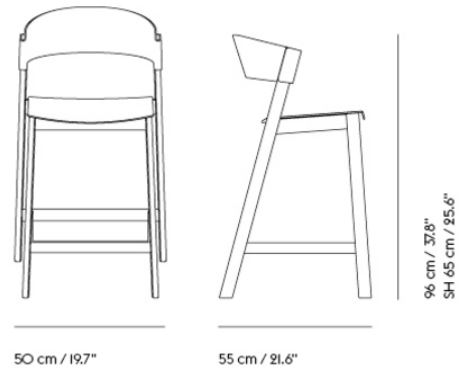

Shipper Colli	1
Gross Weight (kg)	8.75
Net Weight (kg)	5.85
Base color options	Black or Oak
Warranty Period	10 Years

Pattern No.	Color	Contract Price	Lead Time
<b>Ready-To-Ship US Warehouse</b>			
MCVRSTCW-BLCK	Black	USD 902.00	-
MCVRSTCW-DKBE	Dark Beige ***	USD 902.00	-
MCVRSTCW-OAK	Oak	USD 902.00	-
MCVRSTCW-STDB	Stained Dark Brown ***	USD 902.00	-
MCVRSTCU-BLCK-M136BLCK	Refine Leather Black/Black	USD 1,206.00	-
MCVRSTCU-STDB-M136BLCK	Refine Leather Black/Stained Dark Brown	USD 1,206.00	-
MCVRSTCU-OAK-M136COGN	Refine Leather Cognac/Oak	USD 1,206.00	-
<b>Ready-To-Ship EU Warehouse</b>			
MCVRSTCW-GREN	Green	USD 902.00	-
MCVRSTCW-MBLU	Midnight Blue ***	USD 902.00	-
<b>Extras</b>			
MGLDCVSFT4	Felt Glides for the Cover Series (4 pcs per pack) - White	USD 21.00	-
MGLDCVSPT4	Plastic glides for the Cover Series (4 pcs per pack) - White	USD 21.00	-
MLEAKIT	Leather care set for Refine Leather	USD 27.00	-
MFTRSTC	Steel Footrest Protector - Self-Mounting	USD 39.00	-



## All Variants

	Description	Pattern No.	Wood Seat	Contract Price								
				Upholstery Grades								
				COM			CIL			COL		
			A	B	C	E	R	T	U	V	W	
Cover Armchair	Wood Seat	M-CVRA-W	667									
	Upholstered Seat	M-CVRA-U		803	845	866	898	866	933	971	1,034	1,101
Cover Side Chair	Wood Seat	M-CVRS-W	667									
	Upholstered Seat	M-CVRS-U		803	845	866	898	929	933	971	1,034	1,101
Cover Lounge Chair	Wood Seat	M-CVRL-W	1,206									
	Upholstered Seat	M-CVRL-U		1,465	1,626	1,675	1,626	1,675	1,675	1,731	1,626	1,836

## HOW TO CONFIGURE

## ORDER CODE EXAMPLE:

Cover Armchair

Cover Armchair Oak / Steelcut Trio 226

Specify:

- Step 1) Choose variant
- Step 2) Choose wood frame finish option
- Step 3) Choose upholstery
- Step 4) Choose upholstery color

Variant	Cover Armchair Upholstered Seat	MCVRAU
Finish/color	Oak	OAK
Upholstery	Steelcut Trio	M139
Upholstery Color	226	226
Final Pattern No:	MCVRAUOAKM139226	

## Wood Frame - Finish Options

- BLCK - Black
- DKBE - Dark Beige
- GREN - Green (only Armchair & Side Chair)
- OAK - Oak

## Upholstery Options

A	B	C	E	R	T	U	V	W
Ocean (M161)* Remix (M156)	Canvas (M153) Clara (M154) Fiord (M155) Grain (M12659) Manner (M12665) Re-Wool (M4586) Sabi (M8404) Steelcut (M149) SteelCut Trio (M139)	Hallingdal (M146)	Acca (M12660) Beck (M6376) Divina (M150) Divina MD (M147) Divina Melange (M135) Ecriture (M10767) Hearth (M12664) Twill Weave (M142) Vidar (M158)	Easy Leather (M141)	Refine Leather (M136)	Endure	Grace Leather (M12374)	Allure Leather

\*Notes:  
Ocean - Color 3, 21, 32, 50, 52, 80 & 601

# COVER STOOL



## All Variants

Description	Pattern No.	Wood Seat	Contract Price	Upholstery Grades								
				A	COM B	CIL C	E	R	COL T U V W			
Cover Bar Stool	Wood Seat	M-CVRSTB-W	902									
	Upholstered Seat	M-CVRSTB-U		1,024	1,101	1,150	1,150	1,150	1,206	1,255	1,311	1,311
Cover Counter Stool	Wood Seat	M-CVRSTC-W	902									
	Upholstered Seat	M-CVRSTC-U		1,024	1,101	1,150	1,150	1,150	1,206	1,255	1,311	1,311
Cover Bar Stool w. footrest	Wood Seat	M-CVRSTB-WF	933									
	Upholstered Seat	M-CVRSTB-UF		1,101	1,150	1,150	1,206	1,206	1,255	1,255	1,360	1,360
Cover Counter Stool w. footrest	Wood Seat	M-CVRSTC-WF	933									
	Upholstered Seat	M-CVRSTC-UF		1,101	1,150	1,150	1,206	1,206	1,255	1,255	1,360	1,360

### HOW TO CONFIGURE

### ORDER CODE EXAMPLE:

Cover Counter Stool

Cover Counter Stool Oak / Steelcut Trio 226

Specify:

- Step 1) Choose variant
- Step 2) Choose wood frame finish option
- Step 3) Choose upholstery
- Step 4) Choose upholstery color

Variant	Cover Counter Stool Upholstered Seat	M-CVRSTCU
Finish/color	Oak	OAK
Upholstery	Steelcut Trio	M139
Upholstery Color	226	226
Final Pattern No:	M-CVRSTCUOKM139226	

### Wood Frame - Finish Options

- BLCK - Black
- OAK - Oak

### Upholstery Options

A	B	C	E	R	T	U	V	W	
Ocean (M161)* Remix (M156)	Canvas (M153) Clara (M154) Fiord (M155) Grain (M12659) Manner (M12665) Re-Wool (M4586) Sabi (M8404) Steelcut (M149) SteelCut Trio (M139)	Hallingdal (M146)	Acca (M12660) Beck (M6376) Divina (M150) Divina MD (M147) Divina Melange (M135) Ecriture (M10767) Hearth (M12664) Twill Weave (M142) Vidar (M158)	Easy Leather (M141)	Refine Leather (M136)	Endure		Grace Leather (M12374)	Allure Leather

\*Notes:  
Ocean - Color 3, 21, 32, 50, 52, 80 & 601



# DOZE LOUNGE SERIES

FOR MORE INFORMATION,  
EXPLORE BELOW

- ↗ [Product Fact Sheet](#)
- ↗ [Images](#)
- ↗ [Architect Files](#)
- ↗ [Product Declaration](#)
- ↗ [Product Configurator](#)

# DOZE LOUNGE CHAIR HIGH BACK TUBE BASE

103

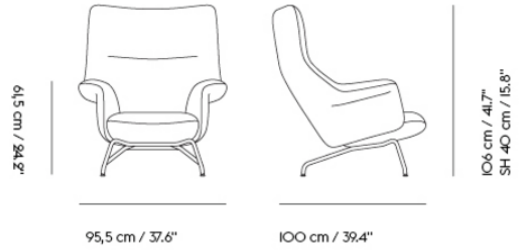

Shipper Colli	1
Gross Weight (kg)	45
Net Weight (kg)	40
Base color options	Anthracite Black, Chrome, Grey
Warranty Period	10 years

Pattern No.	Color	Contract Price	Lead Time
<b>Ready-To-Ship US Warehouse</b>			
MDOZLC-BLCK-M16180	Ocean 80/Anthracite Black	USD 3,096.00	-
MDOZLC-CHRO-M152782	Balder 782/Chrome	USD 3,775.00	-
MDOZLC-BLCK-M136COGN	Refine Leather Cognac/Anthracite Black	USD 4,615.00	-
<b>Ready-To-Ship EU Warehouse</b>			
MDOZLC-CHRO-M4586128	Re-Wool 128/Chrome	USD 3,411.00	-
<b>Extras</b>			
MGLDDLOFB4	Felt Glides for Doze Lounge Chair and Ottoman (4 pcs per pack)	USD 21.00	-
MLEAKIT	Leather care set for Refine Leather	USD 27.00	-

# DOZE LOUNGE CHAIR LOW BACK TUBE BASE

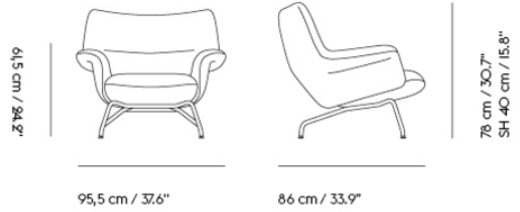

Shipper Colli	1
Gross Weight (kg)	45
Net Weight (kg)	40
Base color options	Anthracite Black, Chrome, Grey
Warranty Period	10 years

Pattern No.	Color	Contract Price	Lead Time
<b>Ready-To-Ship US Warehouse</b>			
MDOZLCLB-BLCK-M16180	Ocean 80/Anthracite Black	USD 2,571.00	-
MDOZLCLB-GREY-M1266407	Hearth 7/Grey	USD 3,096.00	-
<b>Ready-To-Ship EU Warehouse</b>			
87882-BLCK_COGN	Refine Leather Cognac/Anthracite Black	USD 3,355.00	-
<b>Extras</b>			
MGLDDLOFB4	Felt Glides for Doze Lounge Chair and Ottoman (4 pcs per pack)	USD 21.00	-
MLEAKIT	Leather care set for Refine Leather	USD 27.00	-

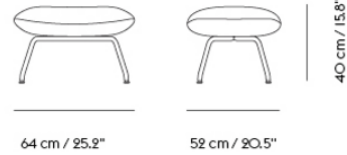
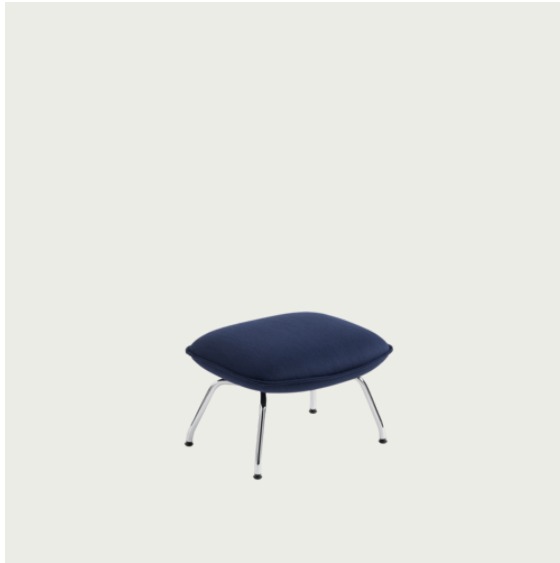

Shipper Colli	1
Gross Weight (kg)	20
Net Weight (kg)	18
Base color options	Anthracite Black, Chrome, Grey
Warranty Period	10 years

Pattern No.	Color	Contract Price	Lead Time
<b>Ready-To-Ship US Warehouse</b>			
MDOZOTT-BLCK-M16180	Ocean 80/Anthracite Black	USD 1,028.00	-
MDOZOTT-CHRO-M152782	Balder 782/Chrome	USD 1,311.00	-
MDOZOTT-BLCK-M136COGN	Refine Leather Cognac/Anthracite Black	USD 1,465.00	-
<b>Ready-To-Ship EU Warehouse</b>			
MDOZOTT-CHRO-M4586128	Re-Wool 128/Chrome	USD 1,150.00	-
<b>Extras</b>			
MGLDDLOFB4	Felt Glides for Doze Lounge Chair and Ottoman (4 pcs per pack)	USD 21.00	-
MLEAKIT	Leather care set for Refine Leather	USD 27.00	-

# DOZE LOUNGE CHAIR HIGH BACK SWIVEL BASE

106

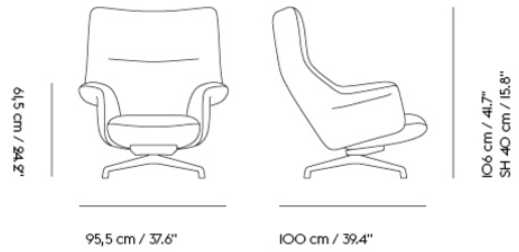

Shipper Colli	1
Gross Weight (kg)	45
Net Weight (kg)	40
Base color options	Anthracite Black, Grey or Polished Aluminum
Warranty Period	10 years

Pattern No.	Color	Contract Price	Lead Time
<b>Ready-To-Ship US Warehouse</b>			
MDOZLC-BLCK-M16180	Ocean 80/Anthracite Black	USD 3,411.00	-
MDOZLC-BLCK-M136COGN	Refine Leather Cognac/Anthracite Black	USD 4,881.00	-
<b>Extras</b>			
MGLDDLOFB4	Felt Glides for Doze Lounge Chair and Ottoman (4 pcs per pack)	USD 21.00	-
MLEAKIT	Leather care set for Refine Leather	USD 27.00	-

# DOZE LOUNGE CHAIR LOW BACK SWIVEL BASE

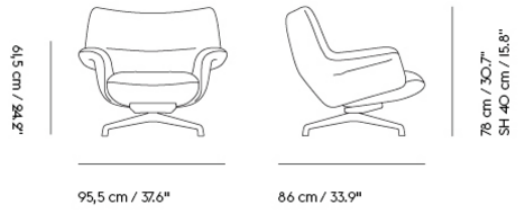

Shipper Colli	1
Gross Weight (kg)	45
Net Weight (kg)	40
Base color options	Anthracite Black, Grey or Polished Aluminum
Warranty Period	10 years

Pattern No.	Color	Contract Price	Lead Time
<b>Ready-To-Ship US Warehouse</b>			
MDOZLCLBSWB-BLCK-M16180	Ocean 80/Anthracite Black	USD 2,830.00	-
MDOZLCLB-GREY-M1266407	Hearth 7/Grey	USD 3,355.00	-
<b>Ready-To-Ship EU Warehouse</b>			
87801-BLCK_COGN	Refine Leather Cognac/Anthracite Black	USD 3,621.00	-
<b>Extras</b>			
MGLDDLOFB4	Felt Glides for Doze Lounge Chair and Ottoman (4 pcs per pack)	USD 21.00	-
MLEAKIT	Leather care set for Refine Leather	USD 27.00	-

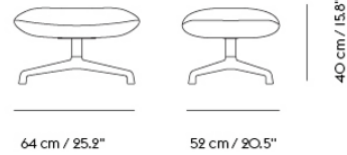
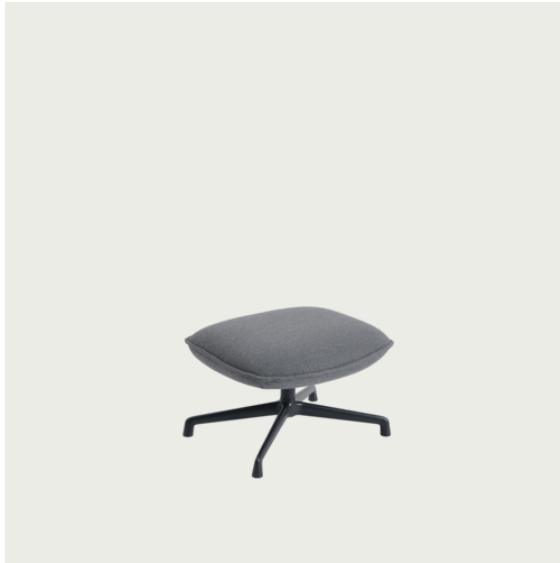

Shipper Colli	1
Gross Weight (kg)	20
Net Weight (kg)	18
Base color options	Anthracite Black, Grey or Polished Aluminum
Warranty Period	10 years

Pattern No.	Color	Contract Price	Lead Time
<b>Ready-To-Ship US Warehouse</b>			
MDOZOTTSWB-BLCK-M16180	Ocean 80/Anthracite Black	USD 1,311.00	-
MDOZOTTSWB-BLCK-M136COGN	Refine Leather Cognac/Anthracite Black	USD 1,731.00	-
<b>Extras</b>			
MGLDDLOFB4	Felt Glides for Doze Lounge Chair and Ottoman (4 pcs per pack)	USD 21.00	-
MLEAKIT	Leather care set for Refine Leather	USD 27.00	-

# DOZE LOUNGE CHAIR & OTTOMAN



All Variants		Contract Price	Upholstery Grades							
			A	COM B	CIL C	E	R	COL T	U	V
Pattern No.										
Doze Lounge Chair High Back Tube Base	M-DOZLC	3,096	3,411	3,565	3,775	4,300	4,615	4,986	5,826	5,980
Doze Lounge Chair High Back Swivel Base	M-DOZLCSWB	3,411	3,621	3,831	4,090	4,405	4,881	5,511	6,085	6,246
Doze Lounge Chair Low Back Tube Base	M-DOZLCLB	2,571	2,830	2,830	3,096	3,201	3,355	3,880	4,146	4,510
Doze Lounge Chair Low Back Swivel Base	M-DOZLCLBSWB	2,830	3,096	3,201	3,355	3,516	3,621	4,146	4,405	4,510
Doze Ottoman Tube Base	M-DOZOTT	1,028	1,150	1,255	1,311	1,416	1,465	1,731	1,836	1,885
Doze Ottoman Swivel Base	M-DOZOTTSWB	1,311	1,416	1,570	1,626	1,570	1,731	1,941	2,095	2,151

HOW TO CONFIGURE

ORDER CODE EXAMPLE

Doze Lounge Specify:

Doze Lounge Chair in Ocean 80 w/anthracite black base

- Step 1) Choose variant
- Step 2) Choose base color
- Step 3) Choose upholstery
- Step 4) Choose upholstery color

Variant: Doze Lounge  
 Base Color: Anthracite Black  
 Upholstery: Ocean  
 Upholstery Color: 80  
 Final Pattern No: MDOZLCBLCKM16180

MDOZLC  
 BLCK  
 M161  
 80

Frame - Finish Options

- BLCK - Anthracite Black
- CHRO - Chrome (Only available on Tube Base)
- ALU - Polished Aluminum (Only available on Swivel Base)
- GREY - Grey

Upholstery Options

A	B	C	E	R	T	U	V	W
Ocean (M161)*	Clara (M154) Fiord (M155) Grain (M12659) Manner (M12665) Re-Wool (M4586) Sabi (M8404) Steelcut (M149) Steelcut Trio (M139)	Hallingdal (M146)	Acca (M12660) Balder (M152) Beck (M6376) Divina (M150) Divina MD (M147) Divina Melange (M135) Ecriture (M10767) Hearth (M12664) Twill Weave (M142) Vidar (M158)	Easy Leather (M141)	Refine Leather (M136)	Endure Leather (M137)	Grace Leather (M12374)	Allure Leather (M12375)

\*Notes:  
Ocean - Color 3, 21, 32, 50, 52, 80 & 601



# EARNEST EXTENDABLE TABLE

FOR MORE INFORMATION,  
EXPLORE BELOW

- ↗ [Product Fact Sheet](#)
- ↗ [Images](#)
- ↗ [Architect Files](#)
- ↗ [Assembly Instructions](#)
- ↗ [Product Declaration](#)

# EARNEST EXTENDABLE TABLE / 205 X 100 CM / 80.75 X 39.5"

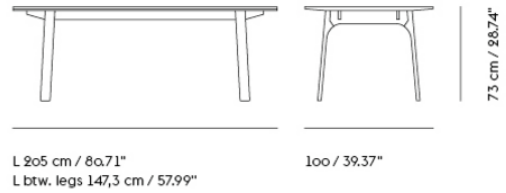
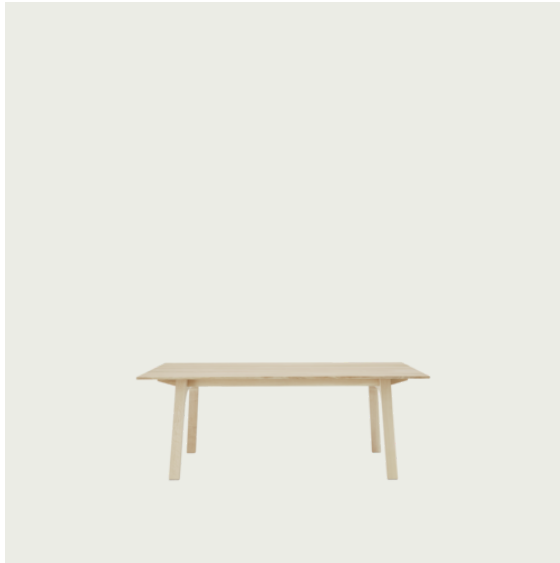

Shipper Colli	1
Gross Weight (kg)	73.6
Net Weight (kg)	62.045
Base color options	Oak, Dark Oiled Oak
Warranty Period	5 years

Pattern No.	Color	Contract Price	Lead Time
<b>Ready-To-Ship US Warehouse</b>			
MERNSTEXT8140-DOAK	Dark Oiled Oak	USD 5,350.00	-
MERNSTEXT8140-OAK	Oiled Oak	USD 5,350.00	-
<b>Extras</b>			
MERNSTEXTL-DOAK	Extension Leaves - Set of 2 - Dark Oiled Oak	USD 1,360.00	-
MERNSTEXTL-OAK	Extension Leaves - Set of 2 - Oiled Oak	USD 1,360.00	-

# EARNEST EXTENDABLE TABLE / 260 X 100 CM / 102.5 X 39.5"

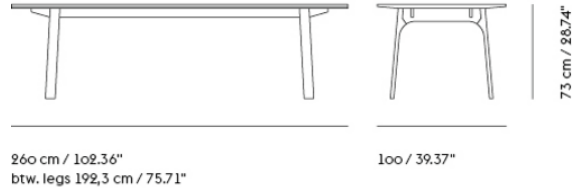
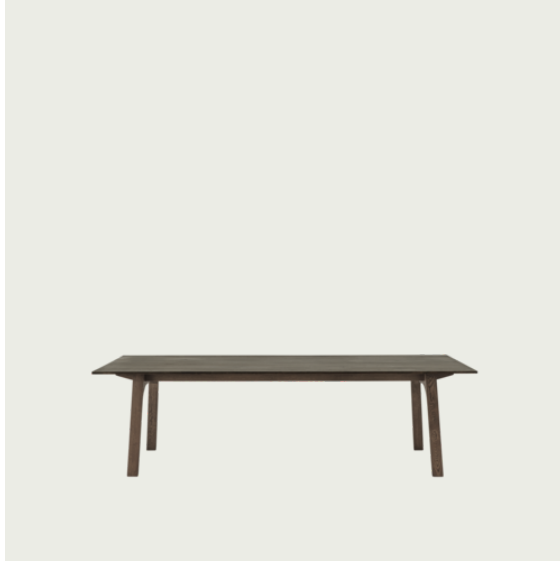

Shipper Colli	1
Gross Weight (kg)	90.4
Net Weight (kg)	71.845
Base color options	Oak, Dark Oiled Oak
Warranty Period	5 years

Pattern No.	Color	Contract Price	Lead Time
<b>Ready-To-Ship US Warehouse</b>			
MERNSTEXT10240-DOAK	Dark Oiled Oak	USD 6,715.00	-
MERNSTEXT10240-OAK	Oiled Oak	USD 6,715.00	-
<b>Extras</b>			
MERNSTEXTL-DOAK	Extension Leaves - Set of 2 - Dark Oiled Oak	USD 1,360.00	-
MERNSTEXTL-OAK	Extension Leaves - Set of 2 - Oiled Oak	USD 1,360.00	-

# ECHO POUF

**FOR MORE INFORMATION,  
EXPLORE BELOW**

- ↗ [Product Fact Sheet](#)
- ↗ [Images](#)
- ↗ [Architect Files](#)
- ↗ [Assembly Instructions](#)
- ↗ [Product Declaration](#)
- ↗ [Product Configurator](#)

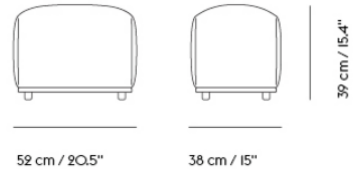

Shipper Colli 1  
 Gross Weight (kg) 15  
 Net Weight (kg) 9  
 Warranty Period 10 years

Pattern No.	Color	Contract Price	Lead Time
<b>Ready-To-Ship US Warehouse</b>			
MECHOP1521-K23401	Attire 1/Black	USD 954.00	-
MECHOP1521-K23406	Attire 6/Black	USD 954.00	-

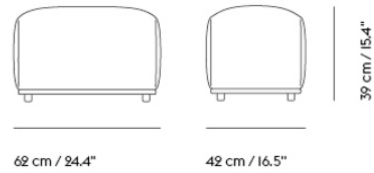

Shipper Colli I  
 Gross Weight (kg) 17  
 Net Weight (kg) 11  
 Warranty Period 10 years

Pattern No.	Color	Contract Price	Lead Time
<b>Ready-To-Ship US Warehouse</b>			
MECHOP1725-K23401	Attire 1/Black	USD 1,024.00	-
MECHOP1725-K23406	Attire 6/Black	USD 1,024.00	-

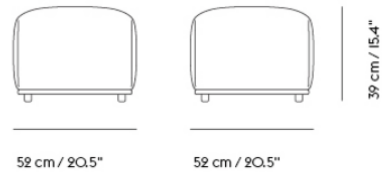

Shipper Colli 1  
 Gross Weight (kg) 18  
 Net Weight (kg) 12  
 Warranty Period 10 years

Pattern No.	Color	Contract Price	Lead Time
<b>Ready-To-Ship US Warehouse</b>			
MECHOP2121-M156163	Remix I63 ***	USD 828.00	-
MECHOP2121-K23401	Attire I/Black	USD 992.00	-

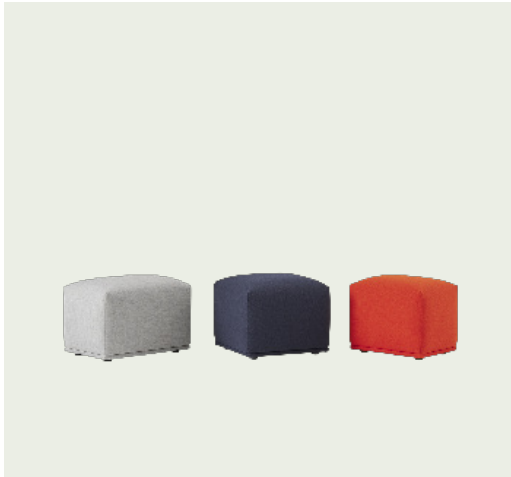

All Variants

		Contract Price			
		Upholstery Grades			
		COM			
Size	Pattern No.	A	B	C	E
38 X 52 CM / 15" x 20.5"	M-ECHOP-1521	755	954	1,013	1,024
42 X 62 CM / 16.5" x 24.4"	M-ECHOP-1725	919	1,024	1,101	1,150
52 X 52 CM / 20.5" x 20.5"	M-ECHOP-2121	828	992	1,024	1,045

HOW TO CONFIGURE

Echo pouf  
Specify:  
Step 1) Choose Size"  
Step 2) Choose textile  
Step 3) Choose textile color

ORDER CODE EXAMPLE

Echo pouf 15 x 20.5" in Ocean 80

Size 15 x 20.5"  
Textile Ocean  
Textile Color 80  
Final Pattern No: MECHOP1521M16180

MECHOP1521  
M161  
80

Upholstery Options

A	B	C	E
Ocean (M161)* Remix (M156)	Cameo (K1443) Canvas (M153) Clara (M154) Fiord (M155) Grain (M12659) Manner (M12665) Steelcut (M149) Steelcut Trio (M139)	Hallingdal (M146)	Acca (M12660) Aegean (K2074) Beck (M6376) Clay (M2449)* Divina (M150) Divina MD (M147) Divina Melange (M135) Ecriture (M10767) Hearth (M12664) Highland (K2010) Twill Weave (M142) Vidar (M158)

\*Notes:

Ocean - Color 3, 21, 32, 50, 52, 80 & 601

Clay - Color 1, 2, 3, 4, 5, 6, 7, 8, 9, 10,11, 12, 13, 14, 15, 16 & 17



# ENFOLD SIDEBOARD

FOR MORE INFORMATION,  
EXPLORE BELOW

- ↗ [Product Fact Sheet](#)
- ↗ [Images](#)
- ↗ [Architect Files](#)
- ↗ [Assembly Instructions](#)
- ↗ [Product Declaration](#)

# ENFOLD SIDEBOARD / 100 X 45 H: 85 CM / 39 X 17.7 H: 33.2"

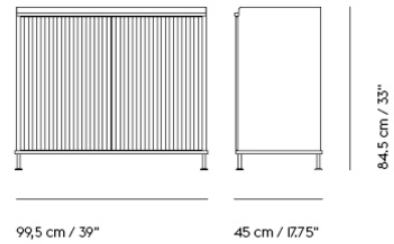

Shipper Colli	1
Gross Weight (kg)	54.16
Net Weight (kg)	41
Please note	This product includes 2 shelves. Up to 4 additional shelves can be added.
Warranty Period	10 years

Pattern No.	Color	Contract Price	Lead Time
<b>Ready-To-Ship US Warehouse</b>			
MENFSBT-BLCK-BLCK	Black/Anthracite Black	USD 2,676.00	-
MENFSBT-OAK-DGRN	Lacquered Oak/Dusty Green	USD 2,676.00	-
MENFSBT-OAK-GREY	Lacquered Oak/Grey	USD 2,676.00	-
MENFSBT-OAK-DPRD	Oiled Oak/Deep Red	USD 2,676.00	-
<b>Ready-To-Ship EU Warehouse</b>			
MENFSBT-OAK-BLCK	Lacquered Oak/Anthracite Black	USD 2,676.00	-
<b>Extras</b>			
MENFSBTES-BLCK	Extra shelf - 100 x 45 H: 85 CM / 39 x 17.7 H: 33.2" and 148 x 45 H: 85 CM / 58 x 17.7 H: 33.2" - Anthracite Black	USD 257.00	-
MENFSBTES-DPRD	Extra shelf - 100 x 45 H: 85 CM / 39 x 17.7 H: 33.2" and 148 x 45 H: 85 CM / 58 x 17.7 H: 33.2" - Deep Red	USD 257.00	-
MENFSBTES-DGRN	Extra shelf - 100 x 45 H: 85 CM / 39 x 17.7 H: 33.2" and 148 x 45 H: 85 CM / 58 x 17.7 H: 33.2" - Dusty Green	USD 257.00	-

**ENFOLD SIDEBOARD / 124 X 45 H: 63 CM / 49 X 17.7 H: 24.6"**

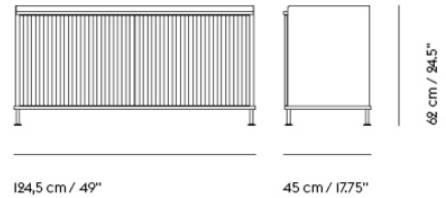

- Shipper Colli 1
- Gross Weight (kg) 42.54
- Net Weight (kg) 38
- Please note This product includes 2 shelves. Up to 4 additional shelves can be added.
- Warranty Period 10 years

Pattern No.	Color	Contract Price	Lead Time
<b>Ready-To-Ship US Warehouse</b>			
MENFSBL-BLCK-BLCK	Black/Anthracite Black	USD 2,676.00	-
MENFSBL-OAK-DGRN	Lacquered Oak/Dusty Green ***	USD 2,676.00	-
MENFSBL-OAK-GREY	Lacquered Oak/Grey	USD 2,676.00	-
MENFSBL-OAK-DPRD	Oiled Oak/Deep Red	USD 2,676.00	-
<b>Ready-To-Ship EU Warehouse</b>			
MENFSBL-OAK-BLCK	Lacquered Oak/Anthracite Black	USD 2,676.00	-
<b>Extras</b>			
MENFSBLES-BLCK	Extra shelf - 124 x 45 H: 63 CM / 49 x 17.7 H: 24.6" and 186 x 45 H: 48 CM / 73 x 17.7 H: 18.9" - Anthracite Black	USD 257.00	-
MENFSBLES-DPRD	Extra shelf - 124 x 45 H: 63 CM / 49 x 17.7 H: 24.6" and 186 x 45 H: 48 CM / 73 x 17.7 H: 18.9" - Deep Red	USD 257.00	-
MENFSBLES-DGRN	Extra shelf - 124 x 45 H: 63 CM / 49 x 17.7 H: 24.6" and 186 x 45 H: 48 CM / 73 x 17.7 H: 18.9" - Dusty Green	USD 257.00	-
MENFSBLES-GREY	Extra shelf - 124 x 45 H: 63 CM / 49 x 17.7 H: 24.6" and 186 x 45 H: 48 CM / 73 x 17.7 H: 18.9" - Grey	USD 257.00	-

# ENFOLD SIDBOARD / 148 X 45 H: 85 CM / 58 X 17.7 H: 33.2"

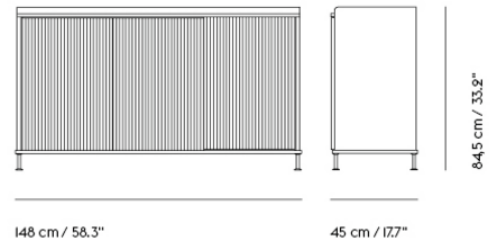

Shipper Colli	1
Gross Weight (kg)	67,55
Net Weight (kg)	52,25
Please note	This product includes 3 shelves. Up to 6 additional shelves can be added.
Warranty Period	10 years

Pattern No.	Color	Contract Price	Lead Time
<b>Ready-To-Ship US Warehouse</b>			
MENFSBTW-BLCK-BLCK	Black/Anthracite Black	USD 3,936.00	-
MENFSBTW-OAK-DPRD	Oiled Oak/Deep Red	USD 3,936.00	-
MENFSBTW-OAK-DGRN	Oiled Oak/Dusty Green	USD 3,936.00	-
<b>Ready-To-Ship EU Warehouse</b>			
MENFSBTW-OAK-BLCK	Oiled Oak/Anthracite Black	USD 3,936.00	-
MENFSBTW-OAK-GREY	Oiled Oak/Grey	USD 3,936.00	-
<b>Extras</b>			
MENFSBTES-BLCK	Extra shelf - 100 x 45 H: 85 CM / 39 x 17.7 H: 33.2" and 148 x 45 H: 85 CM / 58 x 17.7 H: 33.2" - Anthracite Black	USD 257.00	-
MENFSBTES-DPRD	Extra shelf - 100 x 45 H: 85 CM / 39 x 17.7 H: 33.2" and 148 x 45 H: 85 CM / 58 x 17.7 H: 33.2" - Deep Red	USD 257.00	-
MENFSBTES-DGRN	Extra shelf - 100 x 45 H: 85 CM / 39 x 17.7 H: 33.2" and 148 x 45 H: 85 CM / 58 x 17.7 H: 33.2" - Dusty Green	USD 257.00	-

# ENFOLD SIDEBOARD / 186 X 45 H: 48 CM / 73 X 17.7 H: 18.9"

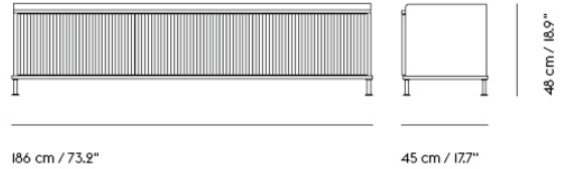
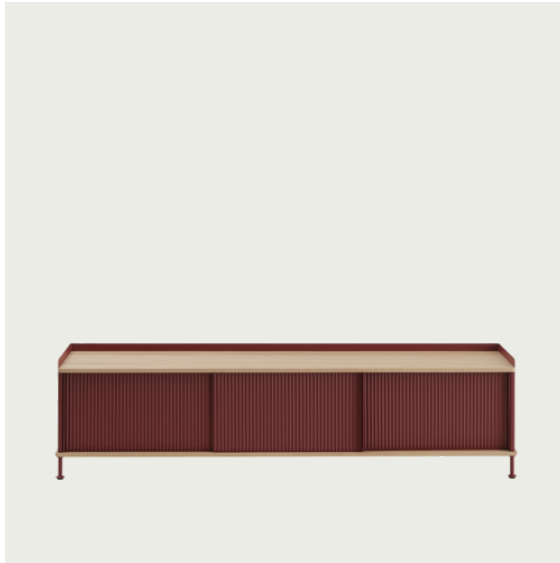

<b>Shipper Colli</b>	1
<b>Gross Weight (kg)</b>	64.74
<b>Net Weight (kg)</b>	48.44
<b>Please note</b>	This product includes 3 shelves. No additional shelves can be added.
<b>Warranty Period</b>	10 years

Pattern No.	Color	Contract Price	Lead Time
<b>Ready-To-Ship US Warehouse</b>			
MENFSBLL-BLCK-BLCK	Black/Anthracite Black	USD 3,936.00	-
MENFSBLL-OAK-DPRD	Oiled Oak/Deep Red	USD 3,936.00	-
MENFSBLL-OAK-DGRN	Oiled Oak/Dusty Green	USD 3,936.00	-
<b>Ready-To-Ship EU Warehouse</b>			
MENFSBLL-OAK-BLCK	Oiled Oak/Anthracite Black	USD 3,936.00	-
MENFSBLL-OAK-GREY	Oiled Oak/Grey	USD 3,936.00	-
<b>Extras</b>			
MENFSBLES-BLCK	Extra shelf - 124 x 45 H: 63 CM / 49 x 17.7 H: 24.6" and 186 x 45 H: 48 CM / 73 x 17.7 H: 18.9" - Anthracite Black	USD 257.00	-
MENFSBLES-DPRD	Extra shelf - 124 x 45 H: 63 CM / 49 x 17.7 H: 24.6" and 186 x 45 H: 48 CM / 73 x 17.7 H: 18.9" - Deep Red	USD 257.00	-
MENFSBLES-DGRN	Extra shelf - 124 x 45 H: 63 CM / 49 x 17.7 H: 24.6" and 186 x 45 H: 48 CM / 73 x 17.7 H: 18.9" - Dusty Green	USD 257.00	-
MENFSBLES-GREY	Extra shelf - 124 x 45 H: 63 CM / 49 x 17.7 H: 24.6" and 186 x 45 H: 48 CM / 73 x 17.7 H: 18.9" - Grey	USD 257.00	-

# FIBER CHAIR SERIES

FOR MORE INFORMATION,  
EXPLORE BELOW

- ↗ [Product Fact Sheet](#)
- ↗ [Images](#)
- ↗ [Architect Files](#)
- ↗ [Assembly Instructions](#)
- ↗ [Product Declaration](#)
- ↗ [Product Configurator](#)

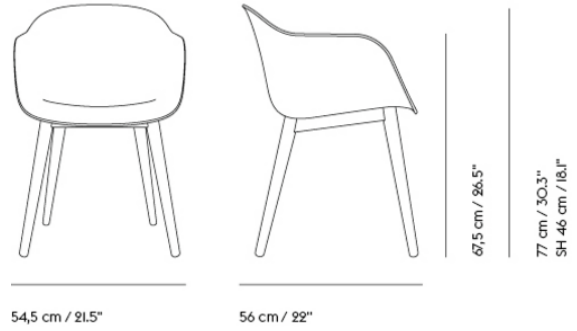

<b>Shipper Colli</b>	1
<b>Gross Weight (kg)</b>	9
<b>Net Weight (kg)</b>	7
<b>Base color options</b>	Anthracite Black, Dusty Green, Grey, Oak or Stained Dark Brown
<b>Warranty Period</b>	10 years

Pattern No.	Color	Contract Price	Lead Time
<b>Ready-To-Ship US Warehouse</b>			
MFIBAWODF-BLCK-BLCK	Black/Anthracite Black (Recycled Plastic)	USD 520.00	-
MFIBAWODF-STDB-BLCK	Black/Stained Dark Brown (Recycled Plastic) ***	USD 520.00	-
MFIBAWODF-GREY-GREY	Grey/Grey (Recycled Plastic)	USD 520.00	-
MFIBAWODF-OAK-WHIT	Natural White/Oak (Recycled Plastic)	USD 520.00	-
MFIBAWODU-GREY-M156133	Remix I33/Grey ***	USD 881.00	-
MFIBAWODU-OAK-M136COGN	Refine Leather Cognac/Oak	USD 1,465.00	-
<b>Ready-To-Ship EU Warehouse</b>			
MFIBAWODF-DGRN-DGRN	Dusty Green/Dusty Green (Recycled Plastic)	USD 520.00	-
MFIBAWODF-OAK-OCHR	Ochre/Oak (Recycled Plastic)	USD 520.00	-
<b>Extras</b>			
MGLDFWDFB4	Felt Glides for Fiber Wood Base (4 pcs per pack) - Black	USD 21.00	-
MGLDFWDFG4	Felt Glides for Fiber Wood Base (4 pcs per pack) - Grey	USD 21.00	-
MLEAKIT	Leather care set for Refine Leather	USD 27.00	-

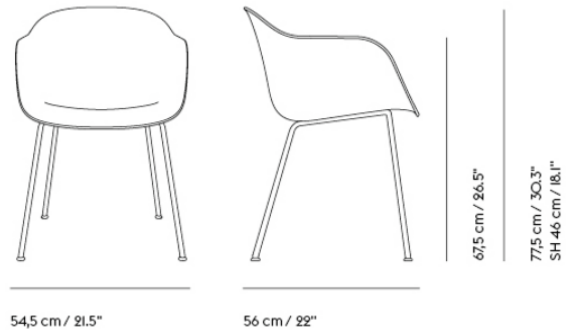

<b>Shipper Colli</b>	1
<b>Gross Weight (kg)</b>	9
<b>Net Weight (kg)</b>	7
<b>Base color options</b>	Anthracite Black, Chrome, Dusty Green, Grey or White
<b>Warranty Period</b>	10 years

Pattern No.	Color	Contract Price	Lead Time
<b>Ready-To-Ship US Warehouse</b>			
MFIBATUBF-BLCK-BLCK	Black/Anthracite Black (Recycled Plastic)	USD 415.00	-
MFIBATUBF-GREY-GREY	Grey/Grey (Recycled Plastic)	USD 415.00	-
MFIBATUBF-WHIT-WHIT	Natural White/White (Recycled Plastic)	USD 415.00	-
MFIBATUBF-BLCK-OCHR	Ochre/Anthracite Black (Recycled Plastic)	USD 415.00	-
MFIBATUBU-BLCK-M136BLCK	Refine Leather Black/Anthracite Black ***	USD 1,416.00	-
MFIBATUBU-BLCK-M136COGN	Refine Leather Cognac/Anthracite Black	USD 1,416.00	-
<b>Ready-To-Ship EU Warehouse</b>			
MFIBATUBF-DGRN-DGRN	Dusty Green/Dusty Green (Recycled Plastic)	USD 415.00	-
<b>Extras</b>			
MGLDOFVTBPB1	Plastic glides for Oslo and Fiber with Tube Base (1 pc per pack) - Black	USD 6.00	-
MGLDOFVTBFB4	Felt Glides for Oslo and Fiber with Tube Base (4 pcs per pack)	USD 21.00	-
MLEAKIT	Leather care set for Refine Leather	USD 27.00	-



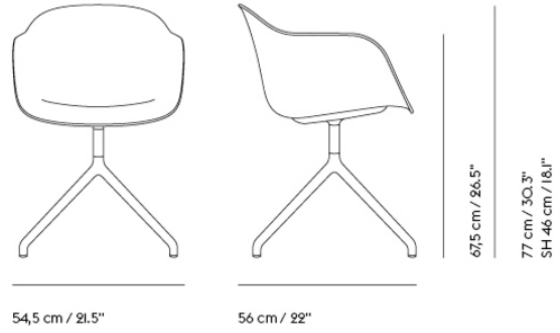

<b>Shipper Colli</b>	1
<b>Gross Weight (kg)</b>	11.9
<b>Net Weight (kg)</b>	7
<b>Base color options</b>	Anthracite Black, White, Grey, Dusty Green or Polished Aluminum.
<b>Warranty Period</b>	10 years

Pattern No.	Color	Contract Price	Lead Time
<b>Ready-To-Ship US Warehouse</b>			
MFIBASWBU-BLCK-M136BLCK	Refine Leather Black/Anthracite Black	USD 1,570.00	-
MFIBASWBU-BLCK-M136COGN	Refine Leather Cognac/Anthracite Black	USD 1,570.00	-
<b>Extras</b>			
MGLDFVSWFB4	Felt Glides for Fiber and Visu with Swivel Base (4 pcs per pack)	USD 21.00	-
MLEAKIT	Leather care set for Refine Leather	USD 27.00	-

# FIBER ARMCHAIR / SWIVEL BASE W. CASTORS & GAS LIFT

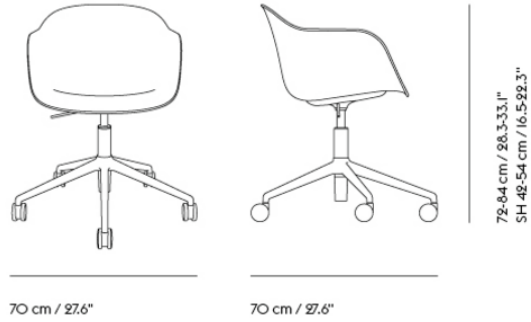

<b>Shipper Colli</b>	1
<b>Gross Weight (kg)</b>	12.6
<b>Net Weight (kg)</b>	7
<b>Base color options</b>	Anthracite Black, Grey and Polished Aluminum with Black castors. White with white castors.
<b>Warranty Period</b>	10 years

Pattern No.	Color	Contract Price	Lead Time
<b>Ready-To-Ship US Warehouse</b>			
MFIBASWGU-ALUM-M156183	Remix I83/Polished Aluminum	USD 1,101.00	-
<b>Extras</b>			
MLEAKIT	Leather care set for Refine Leather	USD 27.00	-

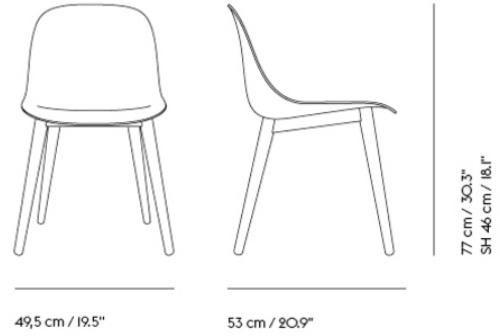

<b>Shipper Colli</b>	1
<b>Gross Weight (kg)</b>	7.4
<b>Net Weight (kg)</b>	5.4
<b>Base color options</b>	Anthracite Black, Dusty Green, Grey, Oak or Stained Dark Brown
<b>Warranty Period</b>	10 years

Pattern No.	Color	Contract Price	Lead Time
<b>Ready-To-Ship US Warehouse</b>			
MFIBSWODF-BLCK-BLCK	Black/Anthracite Black (Recycled Plastic)	USD 488.00	-
MFIBSWODF-STDB-BLCK	Black/Stained Dark Brown (Recycled Plastic) ***	USD 488.00	-
MFIBSWODF-GREY-GREY	Grey/Grey (Recycled Plastic)	USD 488.00	-
MFIBSWODF-OAK-WHIT	Natural White/Oak (Recycled Plastic)	USD 488.00	-
MFIBSWODU-OAK-M136COGN	Refine Leather Cognac/Oak	USD 1,311.00	-
<b>Ready-To-Ship EU Warehouse</b>			
MFIBSWODF-DGRN-DGRN	Dusty Green/Dusty Green (Recycled Plastic)	USD 488.00	-
MFIBSWODF-OAK-OCHR	Ochre/Oak (Recycled Plastic)	USD 488.00	-
<b>Extras</b>			
MGLDFWDFB4	Felt Glides for Fiber Wood Base (4 pcs per pack) - Black	USD 21.00	-
MGLDFWDFG4	Felt Glides for Fiber Wood Base (4 pcs per pack) - Grey	USD 21.00	-
MLEAKIT	Leather care set for Refine Leather	USD 27.00	-



<b>Shipper Colli</b>	1
<b>Gross Weight (kg)</b>	9
<b>Net Weight (kg)</b>	7
<b>Base color options</b>	Anthracite Black, Chrome, Dusty Green, Grey or White
<b>Warranty Period</b>	10 Years

Pattern No.	Color	Contract Price	Lead Time
<b>Ready-To-Ship US Warehouse</b>			
MFIBSTUBF-BLCK-BLCK	Black/Anthracite Black (Recycled Plastic)	USD 383.00	-
MFIBSTUBF-GREY-GREY	Grey/Grey (Recycled Plastic)	USD 383.00	-
MFIBSTUBF-WHIT-WHIT	Natural White/White (Recycled Plastic)	USD 383.00	-
MFIBSTUBF-BLCK-OCHR	Ochre/Anthracite Black (Recycled Plastic)	USD 383.00	-
MFIBSTUBU-BLCK-M136COGN	Refine Leather Cognac/Anthracite Black ***	USD 1,206.00	-
<b>Ready-To-Ship EU Warehouse</b>			
MFIBSTUBF-DGRN-DGRN	Dusty Green/Dusty Green (Recycled Plastic)	USD 383.00	-
<b>Extras</b>			
MGLDOFVTBPB1	Plastic glides for Oslo and Fiber with Tube Base (1 pc per pack) - Black	USD 6.00	-
MGLDOFVTBFB4	Felt Glides for Oslo and Fiber with Tube Base (4 pcs per pack)	USD 21.00	-
MLEAKIT	Leather care set for Refine Leather	USD 27.00	-

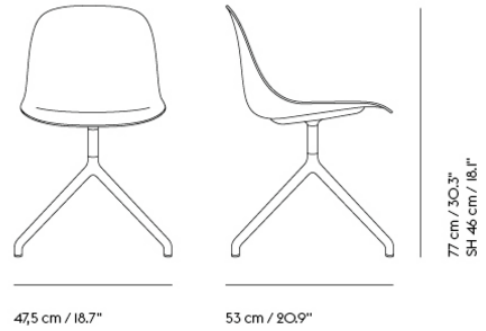

<b>Shipper Colli</b>	1
<b>Gross Weight (kg)</b>	11.9
<b>Net Weight (kg)</b>	7.2
<b>Base color options</b>	Anthracite Black, Dusty Green, Grey, Polished Aluminum or White
<b>Warranty Period</b>	10 years

Pattern No.	Color	Contract Price	Lead Time
<b>Ready-To-Ship US Warehouse</b>			
MFIBSSWBU-BLCK-M136COGN	Refine Leather Cognac/Anthracite Black	USD 1,360.00	-
<b>Extras</b>			
MGLDFVSWFB4	Felt Glides for Fiber and Visu with Swivel Base (4 pcs per pack)	USD 21.00	-
MLEAKIT	Leather care set for Refine Leather	USD 27.00	-

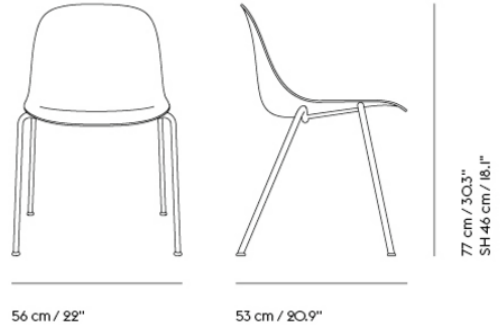

Shipper Colli	1
Gross Weight (kg)	10.3
Net Weight (kg)	7.4
Base color options	Chrome
Stacking	Up to 15 shell or 10 upholstered chairs can be stacked together
Warranty Period	10 years

Pattern No.	Color	Contract Price	Lead Time
<b>Ready-To-Ship US Warehouse</b>			
MFIBSAFGF-CHRO-GREY	Grey/Chrome (Recycled Plastic)	USD 383.00	-
MFIBSAFGF-CHRO-WHIT	Natural White/Chrome (Recycled Plastic)	USD 383.00	-

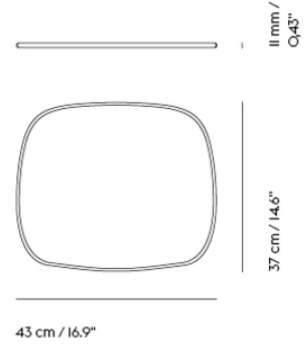

**Shipper Colli** 1  
**Gross Weight (kg)** 0.35  
**Net Weight (kg)** 0.25  
**Warranty Period** 5 years

Pattern No.	Color	Contract Price	Lead Time
<b>Ready-To-Ship US Warehouse</b>			
MFIBASPAD-M156133	Remix I33	USD 93.00	-
MFIBASPAD-M141BLCK	Easy Leather Black	USD 110.00	-

# FIBER ARMCHAIR WOOD, TUBE & SLED BASE

FIBER ARMCHAIR  
WOOD BASE

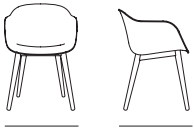

54,5 cm / 21.5"

56 cm / 22"

FIBER ARMCHAIR  
TUBE BASE



54,5 cm / 21.5"

56 cm / 22"

FIBER ARMCHAIR  
SLED BASE

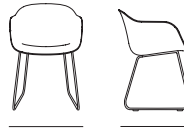

54,5 cm / 21.5"

55 cm / 21.75"

77 cm /  
30.3"  
SH 46 cm /  
18.1"

## All Variants

	Description	Pattern No.	Fiber Shell	COM					CIL					COL				
				A	B	C	E	G	H	R	T	U	V	W				
Fiber Armchair Wood Base	Fiber Shell	MFIBAWODF	520															
	Upholstered Shell	MFIBAWODU		881	1,013	1,150	1,150	1,150	1,465	1,416	1,465	1,570	1,885	2,046				
	Front Upholstery	MFIBAWODFR		866	992	1,101	1,150	1,150	1,465	1,360	1,465	1,570	1,836	1,941				
Fiber Armchair Tube Base	Fiber Shell	MFIBATUBF	415															
	Upholstered Shell	MFIBATUBU		776	902	1,013	1,024	1,101	1,416	1,255	1,416	1,465	1,731	1,885				
	Front Upholstery	MFIBATUBFR		755	881	992	1,013	1,101	1,311	1,255	1,311	1,416	1,731	1,885				
Fiber Armchair Sled Base	Fiber Shell	MFIBASLDF	415															
	Upholstered Shell	MFIBASLDU		776	902	1,013	1,024	1,045	1,416	1,255	1,416	1,465	1,731	1,885				
	Front Upholstery	MFIBASLDFR		755	881	992	1,013	1,101	1,311	1,255	1,311	1,416	1,731	1,885				

## HOW TO CONFIGURE

## ORDER CODE EXAMPLE: Upholstered Shell

Fiber Shell	Upholstered Shell	Front Upholstery	Fiber Armchair Wood Base Steelcut Trio 226						
Specify: Step 1) Choose variant Step 2) Choose base color Step 3) Choose Fiber Shell color	Step 1) Choose variant Step 2) Choose base color Step 3) Choose upholstery Step 4) Choose upholstery color	Step 1) Choose variant Step 2) Choose base color Step 3) Choose Fiber Shell color Step 4) Choose upholstery Step 5) Choose upholstery color	Variant	Base color	Upholstery	Upholstery color	Final Pattern No:	Fiber Armchair Wood Base - Upholstered Oak Steelcut Trio 226 MFIBAWODUOAKM139226	MFIBAWODU OAK M139 226

## Base Color Options

## Shell Color Options\*

## \*When ordering Shell and Front Upholstery versions:

Tube and Sled Base:  
BLCK - Black  
WHIT - White  
DGRN - Dusty Green  
GREY - Grey  
Tube base only: CHRO - Chrome

BLCK - Anthracite Black  
GREY - Grey  
DGRN - Dusty Green  
OCHR - Ochre  
WHIT - Natural White

Base and Shell can be combined as follows

Sled and Tube Base  
BLCK/BLCK - Black/Black Shell  
GREY/GREY - Grey/Grey Shell  
WHIT/WHIT - White/Natural White Shell  
DGRN/DGRN - Dusty Green/Dusty Green  
BLCK/OCHR - Black/Ochre Shell  
CHRO/(all colors) - Chrome/(Choose any of the shell colors)

Wood base:  
OAK - Oak

STDB - Stained Dark Brown  
BLCK - Black  
GREY - Grey  
DGRN - Dusty Green

Wood base:  
BLCK/BLCK - Black/Black Shell  
GREY/GREY - Grey/Grey Shell  
OAK/WHIT - Oak/Natural White Shell  
DGRN/DGRN - Dusty Green/Dusty Green  
OAK/OCHR - Oak/Ochre Shell  
STDB/(all colors) - Stained Dark Brown/(Choose any of the shell colors)

All other combinations are available as specials with a 5% upcharge via dealer portal.

## Upholstery Options

A	B	C	E	G	H	R	T	U	V	W
Ocean (M161)* Remix (M156) Wooly (M159)	Cameo (K1443) Canvas (M153) Clara (M154) Fiord (M155) Grain (M12659) Knoll Hopsack (K1206) Manner (M12665) Prairie (K1925) Re-Wool (M4586) Sabi (M8404) Steelcut (M149) Steelcut Quartet (M13042) Steelcut Trio (M139) Vibe II (K2154)	Hallingdal (M146)	Acca (M12660) Aegean (K2074) Balder (M152) Beck (M6376) Divina (M150) Divina MD (M147) Divina Melange (M135) Ecriture (M10767) Hearth (M12664) Twill Weave (M142) Vidar (M158)	Modern Tweed (K2155)	Stretch Appeal (K2188)	Easy Leather (M141)	Refine Leather (M136)	Endure Leather (M137) Voio Leather (VO)	Grace Leather (M12374)	Allure Leather (M12375)

\*Notes: Ocean - Color 3, 21, 32, 50, 52, 80 & 601



# FIBER ARMCHAIR SWIVEL BASE W. CASTORS & CASTORS & GASLIFT

FIBER ARMCHAIR SWIVEL BASE



54,5 cm / 21.5"

FIBER ARMCHAIR SWIVEL BASE W/CASTORS

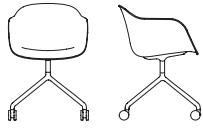

54,5 cm / 21.5" 56 cm / 22"

77 cm / 30.3"  
SH 46 cm / 18.1"

FIBER ARMCHAIR SWIVEL BASE W/CASTORS AND GASLIFT



70 cm / 27.6"

70 cm / 27.6"

72-84 cm / 28.3"-33.1"  
SH 42-54 cm / 16.5"-22.3"

Warranty Period 10 years. 5 years for Swivel base w/return

## All Variants

All Variants	Description	Pattern No.	Fiber Shell	Upholstery Grades								COL			
				A	B	C	E	G	H	R	T	U	V	W	
Fiber Armchair Swivel Base	Fiber Shell	MFIBASWBF	576												
	Upholstered Shell	MFIBASWBU		933	1,101	1,206	1,206	1,206	1,570	1,465	1,570	1,626	1,941	2,095	
	Front Upholstery	MFIBASWFR		919	1,045	1,150	1,206	1,206	1,570	1,416	1,570	1,626	1,885	2,046	
Fiber Armchair Swivel Base w. Return	Fiber Shell	MFIBASWRF	650												
	Upholstered Shell	MFIBASWRU		1,013	1,150	1,255	1,255	1,255	1,626	1,570	1,626	1,675	2,046	2,151	
	Front Upholstery	MFIBASWFR		992	1,150	1,255	1,255	1,255	1,626	1,465	1,626	1,675	2,046	2,151	
Fiber Armchair Swivel Base w. Castors	Fiber Shell	MFIBASWCF	650												
	Upholstered Shell	MFIBASWCU		1,013	1,150	1,255	1,255	1,255	1,626	1,570	1,626	1,675	2,046	2,151	
	Front Upholstery	MFIBASWCFR		992	1,150	1,255	1,255	1,255	1,626	1,465	1,626	1,675	1,941	2,151	
Fiber Armchair Swivel Base w. Castors & Gas Lift	Fiber Shell	MFIBASWGF	734												
	Upholstered Shell	MFIBASWGU		1,101	1,255	1,360	1,416	1,416	1,675	1,626	1,675	1,836	2,095	2,305	
	Front Upholstery	MFIBASWGR		1,101	1,206	1,311	1,360	1,416	1,675	1,626	1,675	1,731	2,095	2,256	

## HOW TO CONFIGURE

## ORDER CODE EXAMPLE: Upholstered Shell

Fiber Shell	Upholstered Shell	Front Upholstery	Fiber Armchair Swivel Base with Castors and Gas Lift Aegean in Egret/Dusty Green		
Specify: Step 1) Choose variant Step 2) Choose base color Step 3) Choose Fiber Shell color	Step 1) Choose variant Step 2) Choose base color Step 3) Choose upholstery Step 4) Choose upholstery color	Step 1) Choose variant Step 2) Choose base color Step 3) Choose Fiber Shell color Step 4) Choose upholstery Step 5) Choose upholstery color	Variant Base color Upholstery Upholstery color Final Pattern No:	Castors and gaslift - Upholstered Dusty Green Aegean Egret MFIBAWODUOAKM139226	M-FIBS-SWG-U DGRN K2074 1

## Base Color Options

Swivel Base and Swivel Base w. Return  
BLCK - Anthracite Black  
WHIT - White  
DGRN - Dusty Green  
GREY - Grey  
ALUM - Polished Aluminum

## Shell Color Options\*

BLCK - Black  
GREY - Grey  
DGRN - Dusty Green  
OCHR - Ochre  
WHIT - Natural White

## \*When ordering Shell and Front Upholstery versions:

Base and Shell can be combined as follows  
Swivel Base, Swivel Base w. Return and Swivel Base with castors  
BLCK/BLCK - Black/Black Shell  
GREY/GREY - Grey/Grey Shell  
WHIT/WHIT - White/Natural White Shell  
DGRN/DGRN - Dusty Green/Dusty Green

## Swivel base with castors and Swivel base w castors & Gaslift

BLCK - Anthracite black with black castors  
GREY - Grey with black castors  
ALUM - Polished Aluminum with black castors  
WHIT - White with white castors

Swivel base w castors & Gaslift  
BLCK/BLCK - Black/Black Shell  
GREY/GREY - Grey/Grey Shell  
WHIT/WHIT - White/Natural White Shell

Polished aluminum combined with any shell color and all other color combinations are available as a special via dealer portal.

## Upholstery Options

A	B	C	E	G	H	R	T	U	V	W
Ocean (M161)* Remix (M156) Wooly (M159)	Cameo (K1443) Canvas (M153) Clara (M154) Fiord (M155) Grain (M12659) Knoll Hopsack (K1206) Manner (M12665) Prairie (K1925) Re-Wool (M4586) Sabi (M8404) Steelcut (M149) Steelcut Quartet (M13042) Steelcut Trio (M139) Vibe II (K2154)	Hallingdal (M146)	Acca (M12660) Aegean (K2074) Balder (M152) Beck (M6376) Divina (M150) Divina MD (M147) Divina Melange (M135) Ecriture (M10767) Hearth (M12664) Twill Weave (M142) Vidar (M158)	Modern Tweed (K2155)	Stretch Appeal (K2188)	Easy Leather (M141)	Refine Leather (M136)	Endure Leather (M137) Volo Leather (VO)	Grace Leather (M12374)	Allure Leather (M12375)

\*Notes: Ocean - Color 3, 21, 32, 50, 52, 80 & 601

# FIBER SIDE CHAIR WOOD, TUBE & SLED BASE

FIBER SIDE CHAIR  
WOOD BASE



49,5 cm / 19.5"    53 cm / 21"

FIBER SIDE CHAIR  
TUBE BASE



51 cm / 20"    53 cm / 21"

FIBER SIDE CHAIR  
SLED BASE



47,5 cm / 18.75"    51,5 cm / 20.3"

77 cm /  
30.3"  
SH 46 cm /  
18"

## All Variants

	Description	Pattern No.	Fiber Shell	Upholstery Grades							COL			
				COM A	COM B	CIL C	E	G	H	R	T	U	V	W
Fiber Side Chair Wood Base	Fiber Shell	M-FIBS-WOD-F	488											
	Upholstered Shell	M-FIBS-WOD-U		786	919	1,045	1,045	1,101	1,311	1,206	1,311	1,416	1,675	1,836
Fiber Side Chair Tube Base	Fiber Shell	M-FIBS-TUB-F	383											
	Upholstered Shell	M-FIBS-TUB-U		681	807	919	933	954	1,206	1,101	1,206	1,255	1,570	1,675
Fiber Side Chair Sled Base	Fiber Shell	M-FIBS-SLD-F	383											
	Upholstered Shell	M-FIBS-SLD-U		681	807	919	933	954	1,206	1,101	1,206	1,255	1,570	1,675

## HOW TO CONFIGURE

### ORDER CODE EXAMPLE: Upholstered Shell

#### Fiber Shell

#### Upholstered Shell

#### Fiber Side Chair Wood Base Aegean in Egret/Dusty Green

#### Specify:

- Step 1) Choose variant
- Step 2) Choose base color
- Step 3) Choose Fiber Shell color

- Step 1) Choose variant
- Step 2) Choose base color
- Step 3) Choose upholstery
- Step 4) Choose upholstery color

Variant	Fiber Side Chair Wood Base - upholstered	M-FIBS-SWG-U
Base color	Oak	OAK
Upholstery	Steelcut Trio	M139
Upholstery color	226	2261
Final Pattern No:	MFIBSWODUOAKM139226	

#### Base Color Options

Tube and Sled Base:  
BLCK - Black  
WHIT - White  
DGRN - Dusty Green  
GREY - Grey  
Tube base only: CHRO - Chrome

Wood base:  
OAK - Oak

STDB - Stained Dark Brown  
BLCK - Black  
GREY - Grey  
DGRN - Dusty Green

#### Shell Color Options\*

BLCK - Anthracite Black  
GREY - Grey  
DGRN - Dusty Green  
OCHR - Ochre  
WHIT - Natural White

#### \*When ordering Shell and Front Upholstery versions:

Base and Shell can be combined as follows

Sled and Tube Base  
BLCK/BLCK - Black/Black Shell  
GREY/GREY - Grey/Grey Shell  
WHIT/WHIT - White/Natural White Shell  
DGRN/DGRN - Dusty Green/Dusty Green  
BLCK/OCHR - Black/Ochre Shell  
CHRO/(all colors) - Chrome/(Choose any of the shell colors)

Wood base:  
BLCK/BLCK - Black/Black Shell  
GREY/GREY - Grey/Grey Shell  
OAK/WHIT - Oak/Natural White Shell  
DGRN/DGRN - Dusty Green/Dusty Green  
OAK/OCHR - Oak/Ochre Shell  
STDB/(all colors) - Stained Dark Brown/(Choose any of the shell colors)  
All other combinations are available as specials with a 5% upcharge via dealer portal.

#### Upholstery Options

A	B	C	E	G	H	R	T	U	V	W
Ocean (M161)* Remix (M156) Wooly (M159)	Cameo (K1443) Canvas (M153) Clara (M154) Fiord (M155) Grain (M12659) Knoll Hopsack (K1206) Manner (M12665) Prairie (K1925) Re-Wool (M4586) Sabi (M8404) Steelcut (M149) Steelcut Quartet (M13042) Steelcut Trio (M139) Vibe II (K2154)	Hallingdal (M146)	Acca (M12660) Aegean (K2074) Balder (M152) Beck (M6376) Divina (M150) Divina MD (M147) Divina Melange (M135) Ecriture (M10767) Hearth (M12664) Twill Weave (M142) Vidar (M158)	Modern Tweed (K2155)	Stretch Appeal (K2188)	Easy Leather (M141)	Refine Leather (M136)	Endure Leather (M137) Volo Leather (VO)	Grace Leather (M12374)	Allure Leather (M12375)

\*Notes:  
Ocean - Color 3, 21, 32, 50, 52, 80 & 601

# FIBER SIDE CHAIR SWIVEL BASE W. CASTORS & CASTORS & GASLIFT

FIBER SIDE CHAIR  
SWIVEL BASE



47,5 cm / 18.75" 53 cm / 21"

FIBER SIDE CHAIR  
SWIVEL BASE W/CASTORS

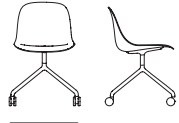

47,5 cm / 18.75" 53 cm / 21"

77 cm /  
30.3"  
SH 46 cm /  
18.1"

FIBER SIDE CHAIR SWIVEL BASE  
W/CASTORS AND GASLIFT



70 cm / 27.6" 70 cm / 27.6"

72-84 cm /  
28.3"-33.1"  
SH 42-54 cm /  
16.5"-22.3"

Warranty Period 10 years. 5 years for Swivel base w/return

## All Variants

Description	Pattern No.	Fiber Shell	Upholstery Grades														
			COM					CIL				COL					
			A	B	C	E	G	H	R	T	U	V	W				
<b>Fiber Side Chair Swivel Base</b>	Fiber Shell M-FIBS-SWB-F	541															
Upholstered Shell	M-FIBS-SWB-U		849	971	1,101	1,101	1,150	1,360	1,206	1,360	1,416	1,731	1,836				
<b>Fiber Side Chair Swivel Base w. Return</b>	Fiber Shell M-FIBS-SWR-F	614															
Upholstered Shell	M-FIBS-SWR-U		919	1,045	1,150	1,206	1,206	1,416	1,311	1,416	1,570	1,836	1,885				
<b>Fiber Side Chair Swivel Base w. Castors</b>	Fiber Shell M-FIBS-SWC-F	614															
Upholstered Shell	M-FIBS-SWC-U		919	1,045	1,150	1,206	1,206	1,416	1,311	1,416	1,570	1,836	1,885				
<b>Fiber Side Chair Swivel Base w. Castors &amp; Gas Lift</b>	Fiber Shell M-FIBS-SWG-F	702															
Upholstered Shell	M-FIBS-SWG-U		1,013	1,150	1,255	1,255	1,311	1,570	1,416	1,570	1,626	1,885	2,046				

## HOW TO CONFIGURE

## ORDER CODE EXAMPLE: Upholstered Shell

Fiber Shell	Upholstered Shell	Fiber Side Chair Swivel Base with Castors and Gas Lift Aegean in Egret/Dusty Green		
Specify: Step 1) Choose variant Step 3) Choose fiber shell color	Step 1) Choose variant Step 3) Choose upholstery	Variant Base color Upholstery Upholstery color Final Pattern No:	Castors and gaslift upholstered Dusty Green Aegean Egret 1 M-FIBSSWGUDGRNK20741	M-FIBS-SWG-U DGRN K2074

## Base Color Options

## Shell Color Options\*

\*When ordering Shell and Front Upholstery versions:

Swivel Base and Swivel Base w. Return  
BLCK - Anthracite Black  
WHIT - White  
DGRN - Dusty Green  
GREY - Grey  
ALUM - Polished Aluminum

BLCK - Black  
GREY - Grey  
DGRN - Dusty Green  
OCHR - Ochre  
WHIT - Natural White

Base and Shell can be combined as follows  
Swivel Base, Swivel Base w. Return and Swivel Base with castors  
BLCK/BLCK - Black/Black Shell  
GREY/GREY - Grey/Grey Shell  
WHIT/WHIT - White/Natural White Shell  
DGRN/DGRN - Dusty Green/Dusty Green

Swivel base with castors and Swivel base w castors & Gaslift  
BLCK - Anthracite black with black castors  
GREY - Grey with black castors  
ALUM - Polished Aluminum with black castors  
WHIT - White with white castors

Swivel base w castors & Gaslift  
BLCK/BLCK - Black/Black Shell  
GREY/GREY - Grey/Grey Shell  
WHIT/WHIT - White/Natural White Shell

Polished aluminum combined with any shell color and all other color combinations are available as a special via dealer portal.

## Upholstery Options

A	B	C	E	G	H	R	T	U	V	W
Ocean (M161)* Remix (M156) Wooly (M159)	Cameo (K1443) Canvas (M153) Clara (M154) Fiord (M155) Grain (M12659) Knoll Hopsack (K1206) Manner (M12665) Prairie (K1925) Re-Wool (M4586) Sabi (M8404) Steelcut (M149) Steelcut Quartet (M13042) Steelcut Trio (M139) Vibe II (K2154)	Hallingdal (M146)	Acca (M12660) Aegean (K2074) Balder (M152) Beck (M6376) Divina (M150) Divina MD (M147) Divina Melange (M135) Ecriture (M10767) Hearth (M12664) Twill Weave (M142) Vidar (M158)	Modern Tweed (K2155)	Stretch Appeal (K2188)	Easy Leather (M141)	Refine Leather (M136)	Endure Leather (M137) Volo Leather (VO)	Grace Leather (M12374)	Allure Leather (M12375)

\*Notes:  
Ocean - Color 3, 21, 32, 50, 52, 80 & 601

# FIBER SIDE CHAIR A-BASE



FIBER ARMCHAIR SLED BASE

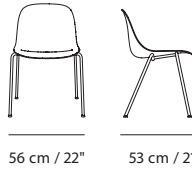

56 cm / 22"      53 cm / 21"

FIBER SIDE CHAIR A-BASE W/LINKING DEVICE



77 cm / 30.3"  
SH 46 cm / 18"

Stacking      Up to 15 shell or 10 upholstered chairs can be stacked together  
Warranty Period      10 years

## All Variants

Description	Pattern No.	Fiber Shell	Upholstery Grades				
			A	COM B	CIL C	E	G
Fiber Side Chair A-Base w. Glides	Fiber Shell	M-FIBS-AGD-F	383				
	Upholstered Shell	M-FIBS-AGD-U		681	807	919	933
Fiber Side Chair A-Base w. Felt Glides	Fiber Shell	M-FIBS-AFG-F	394				
	Upholstered Shell	M-FIBS-AFG-U		702	828	933	954
Fiber Side Chair A-Base w. Linking Device	Fiber Shell	M-FIBS-ALD-F	383				
	Upholstered Shell	M-FIBS-ALD-U		702	828	933	954
Fiber Side Chair A-Base w. Linking Device & Felt Glides	Fiber Shell	M-FIBS-ALF-F	394				
	Upholstered Shell	M-FIBS-ALF-U		681	849	954	971

## HOW TO CONFIGURE

### ORDER CODE EXAMPLE: Upholstered Shell

Fiber Shell	Upholstered Shell	Fiber Side Chair A-Base w/felt glides in Knoll Hopsack Olive	
Specify: Step 1) Choose variant Step 2) Choose shell color	Step 1) Choose variant Step 2) Choose base Color Step 3) Choose upholstery Step 4) Choose upholstery color	Variant Color Upholstery Upholstery color Final Pattern No:	M-FIBS-AFG-U-CHRO K1206 Knoll Hopsack Olive MFIBSAFGUCHROK1206

## Base Color Options

## Shell Finish Options

A-base: CHRO - Chrome	BLCK - Black GREY - Grey DGRN - Dusty Green OCHR - Ochre WHIT - Natural White
--------------------------	---

## Upholstery Options

A	B	C	E	G
Ocean (M161)* Remix (M156) Wooly (M159)	Cameo (K1443) Canvas (M153) Clara (M154) Fiord (M155) Grain (M12659) Knoll Hopsack (K1206) Manner (M12665) Prairie (K1925) Re-Wool (M4586) Sabi (M8404) Steelcut (M149) Steelcut Quartet (M13042) Steelcut Trio (M139) Vibe II (K2154)	Hallingdal (M146)	Acca (M12660) Aegean (K2074) Balder (M152) Beck (M6376) Divina (M150) Divina MD (M147) Divina Melange (M135) Ecriture (M10767) Hearth (M12664) Twill Weave (M142) Vidar (M158)	Modern Tweed (K2155)

\*Notes:  
Ocean - Color 3, 21, 32, 50, 52, 80 & 601

# FIBER BAR & COUNTER SERIES

FOR MORE INFORMATION,  
EXPLORE BELOW

- ↗ [Product Fact Sheet](#)
- ↗ [Images](#)
- ↗ [Architect Files](#)
- ↗ [Assembly Instructions](#)
- ↗ [Product Declaration](#)
- ↗ [Product Configurator](#)

# FIBER COUNTER STOOL / WOOD BASE - 65 CM / 25.6"

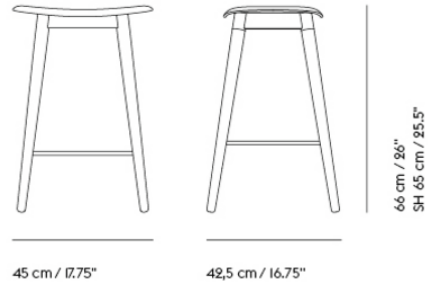

<b>Shipper Colli</b>	1
<b>Gross Weight (kg)</b>	6.1
<b>Net Weight (kg)</b>	4.6
<b>Base color options</b>	Anthracite Black, Dusty Green, Grey, Oak or Stained Dark Brown
<b>Warranty Period</b>	10 years

Pattern No.	Color	Contract Price	Lead Time
<b>Ready-To-Ship US Warehouse</b>			
MFIBSTWODCF-BLCK-BLCK	Black/Anthracite Black	USD 541.00	-
MFIBSTWODCF-GREY-GREY	Grey/Grey	USD 541.00	-
MFIBSTWODCF-OAK-WHIT	Natural White/Oak	USD 541.00	-
MFIBSTWODCU-OAK-M136COGN	Refine Leather Cognac/Oak	USD 1,013.00	-
<b>Extras</b>			
MGLDFWDFB4	Felt Glides for Fiber Wood Base (4 pcs per pack) - Black	USD 21.00	-
MGLDFWDFG4	Felt Glides for Fiber Wood Base (4 pcs per pack) - Grey	USD 21.00	-
MLEAKIT	Leather care set for Refine Leather	USD 27.00	-

# FIBER COUNTER STOOL / WOOD BASE - WITH BACKREST - 65 CM / 25.6"



Shipper Colli	1
Gross Weight (kg)	7.2
Net Weight (kg)	5.7
Base color options	Anthracite Black, Dusty Green, Grey, Oak or Stained Dark Brown
Warranty Period	10 years

Pattern No.	Color	Contract Price	Lead Time
<b>Ready-To-Ship US Warehouse</b>			
MFIBSTWODCBF-BLCK-BLCK	Black/Anthracite Black (Recycled Plastic)	USD 576.00	-
MFIBSTWODCBF-STDB-BLCK	Black/Stained Dark Brown (Recycled Plastic) ***	USD 576.00	-
MFIBSTWODCBF-OAK-WHIT	Natural White/Oak	USD 576.00	-
MFIBSTWODCBU-OAK-M136COGN	Refine Leather Cognac/Oak	USD 1,206.00	-
<b>Ready-To-Ship EU Warehouse</b>			
MFIBSTWODCBF-GREY-GREY	Grey/Grey (Recycled Plastic)	USD 576.00	-
<b>Extras</b>			
MGLDFWDFB4	Felt Glides for Fiber Wood Base (4 pcs per pack) - Black	USD 21.00	-
MGLDFWDFG4	Felt Glides for Fiber Wood Base (4 pcs per pack) - Grey	USD 21.00	-
MLEAKIT	Leather care set for Refine Leather	USD 27.00	-

# FIBER BAR STOOL / WOOD BASE - 75 CM / 29.5"

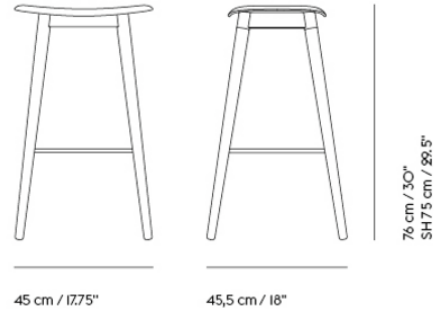

Shipper Colli	1
Gross Weight (kg)	7.1
Net Weight (kg)	5.1
Base color options	Anthracite Black, Dusty Green, Grey, Oak or Stained Dark Brown
Warranty Period	10 years

Pattern No.	Color	Contract Price	Lead Time
<b>Ready-To-Ship US Warehouse</b>			
MFIBSTWODBF-BLCK-BLCK	Black/Anthracite Black (Recycled Plastic)	USD 541.00	-
MFIBSTWODBF-GREY-GREY	Grey/Grey	USD 541.00	-
MFIBSTWODBF-OAK-WHIT	Natural White/Oak (Recycled Plastic)	USD 541.00	-
MFIBSTWODBU-BLCK-M136BLCK	Refine Leather Black/Anthracite Black ***	USD 1,013.00	-
MFIBSTWODBU-OAK-M136COGN	Refine Leather Cognac/Oak	USD 1,013.00	-
<b>Extras</b>			
MGLDFWDFB4	Felt Glides for Fiber Wood Base (4 pcs per pack) - Black	USD 21.00	-
MGLDFWDFG4	Felt Glides for Fiber Wood Base (4 pcs per pack) - Grey	USD 21.00	-
MLEAKIT	Leather care set for Refine Leather	USD 27.00	-



# FIBER BAR STOOL / WOOD BASE - WITH BACKREST - 75 CM / 29.5"



Shipper Colli	1
Gross Weight (kg)	8.2
Net Weight (kg)	6.2
Base color options	Anthracite Black, Dusty Green, Grey, Oak or Stained Dark Brown
Warranty Period	10 years

Pattern No.	Color	Contract Price	Lead Time
<b>Ready-To-Ship US Warehouse</b>			
MFIBSTWODBBF-BLCK-BLCK	Black/Anthracite Black (Recycled Plastic)	USD 576.00	-
MFIBSTWODBBF-STDB-BLCK	Black/Stained Dark Brown ***	USD 576.00	-
MFIBSTWODBBF-GREY-GREY	Grey/Grey	USD 576.00	-
MFIBSTWODBBF-OAK-WHIT	Natural White/Oak (Recycled Plastic)	USD 576.00	-
MFIBSTWODBBU-BLCK-M136BLCK	Refine Leather Black/Anthracite Black ***	USD 1,206.00	-
MFIBSTWODBBU-OAK-M136COGN	Refine Leather Cognac/Oak	USD 1,206.00	-
<b>Extras</b>			
MGLDFWDFB4	Felt Glides for Fiber Wood Base (4 pcs per pack) - Black	USD 21.00	-
MGLDFWDFG4	Felt Glides for Fiber Wood Base (4 pcs per pack) - Grey	USD 21.00	-
MLEAKIT	Leather care set for Refine Leather	USD 27.00	-

# FIBER COUNTER STOOL / TUBE BASE - 65 CM / 25.6"

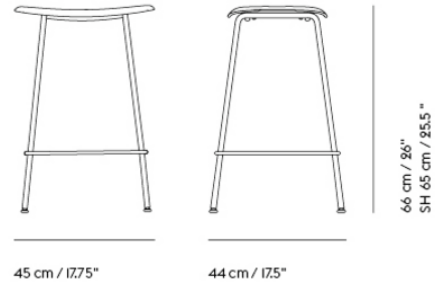

<b>Shipper Colli</b>	1
<b>Gross Weight (kg)</b>	6.1
<b>Net Weight (kg)</b>	4.6
<b>Base color options</b>	Anthracite Black, Dusty Green, Grey or White
<b>Warranty Period</b>	10 years

Pattern No.	Color	Contract Price	Lead Time
<b>Ready-To-Ship US Warehouse</b>			
MFIBSTTUBCF-BLCK-BLCK	Black/Anthracite Black (Recycled Plastic)	USD 341.00	-
MFIBSTTUBCF-GREY-GREY	Grey/Grey ***	USD 341.00	-
MFIBSTTUBCF-WHIT-WHIT	Natural White/White ***	USD 341.00	-
MFIBSTTUBCU-BLCK-M136BLCK	Refine Leather Black/Anthracite Black ***	USD 803.00	-
MFIBSTTUBCU-BLCK-M136COGN	Refine Leather Cognac/Anthracite Black	USD 803.00	-
<b>Extras</b>			
MGLDOFVTBPB1	Plastic glides for Oslo and Fiber with Tube Base (1 pc per pack) - Black	USD 6.00	-
MGLDOFVTBFB4	Felt Glides for Oslo and Fiber with Tube Base (4 pcs per pack)	USD 21.00	-
MLEAKIT	Leather care set for Refine Leather	USD 27.00	-

# FIBER COUNTER STOOL / TUBE BASE - WITH BACKREST - 65 CM / 25.6"

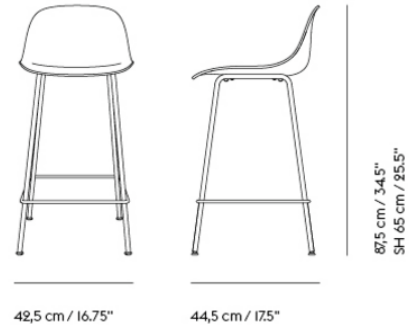

Shipper Colli	1
Gross Weight (kg)	7.2
Net Weight (kg)	5.7
Base color options	Anthracite Black, Dusty Green, Grey or White
Warranty Period	10 years

Pattern No.	Color	Contract Price	Lead Time
<b>Ready-To-Ship US Warehouse</b>			
MFIBSTTUBCBF-BLCK-BLCK	Black/Anthracite Black (Recycled Plastic)	USD 383.00	-
MFIBSTTUBCBF-GREY-GREY	Grey/Grey	USD 383.00	-
MFIBSTTUBCBF-WHIT-WHIT	Natural White/White (Recycled Plastic)	USD 383.00	-
MFIBSTTUBCBU-BLCK-M136COGN	Refine Leather Cognac/Anthracite Black	USD 1,013.00	-
<b>Extras</b>			
MGLDOFVTBPB1	Plastic glides for Oslo and Fiber with Tube Base (1 pc per pack) - Black	USD 6.00	-
MGLDOFVTBFB4	Felt Glides for Oslo and Fiber with Tube Base (4 pcs per pack)	USD 21.00	-
MLEAKIT	Leather care set for Refine Leather	USD 27.00	-

# FIBER BAR STOOL / TUBE BASE - 75 CM / 29.5"

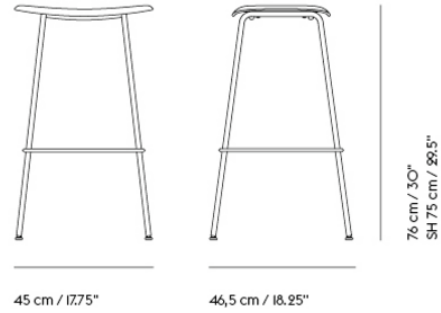

Shipper Colli	1
Gross Weight (kg)	7.1
Net Weight (kg)	5.1
Base color options	Anthracite Black, Dusty Green, Grey or White
Warranty Period	10 years

Pattern No.	Color	Contract Price	Lead Time
<b>Ready-To-Ship US Warehouse</b>			
MFIBSTTUBBF-BLCK-BLCK	Black/Anthracite Black	USD 341.00	-
MFIBSTTUBBF-GREY-GREY	Grey/Grey	USD 341.00	-
MFIBSTTUBBF-WHIT-WHIT	Natural White/White	USD 341.00	-
MFIBSTTUBBU-BLCK-M136BLCK	Refine Leather Black/Anthracite Black ***	USD 803.00	-
MFIBSTTUBBU-BLCK-M136COGN	Refine Leather Cognac/Anthracite Black	USD 803.00	-
<b>Extras</b>			
MGLDOFVTBPB1	Plastic glides for Oslo and Fiber with Tube Base (1 pc per pack) - Black	USD 6.00	-
MGLDOFVTBFB4	Felt Glides for Oslo and Fiber with Tube Base (4 pcs per pack)	USD 21.00	-
MLEAKIT	Leather care set for Refine Leather	USD 27.00	-

# FIBER BAR STOOL / TUBE BASE - WITH BACKREST - 75 CM / 29.5"



Shipper Colli	1
Gross Weight (kg)	8.2
Net Weight (kg)	6.2
Base color options	Anthracite Black, Dusty Green, Grey or White
Warranty Period	10 years

Pattern No.	Color	Contract Price	Lead Time
<b>Ready-To-Ship US Warehouse</b>			
MFIBSTTUBBBF-BLCK-BLCK	Black/Anthracite Black (Recycled Plastic)	USD 383.00	-
MFIBSTTUBBBF-GREY-GREY	Grey/Grey (Recycled Plastic)	USD 383.00	-
MFIBSTTUBBBF-WHIT-WHIT	Natural White/White	USD 383.00	-
MFIBSTTUBBBF-BLCK-OCHR	Ochre/Black (Recycled Plastic)	USD 383.00	-
MFIBSTTUBBBU-BLCK-M136COGN	Refine Leather Cognac/Anthracite Black	USD 1,013.00	-
<b>Extras</b>			
MGLDOFVTBPB1	Plastic glides for Oslo and Fiber with Tube Base (1 pc per pack) - Black	USD 6.00	-
MGLDOFVTBFB4	Felt Glides for Oslo and Fiber with Tube Base (4 pcs per pack)	USD 21.00	-
MLEAKIT	Leather care set for Refine Leather	USD 27.00	-

# FIBER STOOL

## All Variants

Description	Pattern No.	Fiber Shell	Upholstery Grades											
			A	B	C	E	G	H	R	T	U	V	W	
Fiber Stool Tube Base	Fiber Shell	M-FIBST-TUB-S-F	289											
	Upholstered Shell	M-FIBST-TUB-S-U		488	520	562	576	597	629	614	629	719	971	971
Fiber Counter Stool Tube Base	Fiber Shell	M-FIBST-TUB-C-F	341											
	Upholstered Shell	M-FIBST-TUB-C-U		597	650	681	702	719	803	719	803	828	1,101	1,101
Fiber Bar Stool Tube Base	Fiber Shell	M-FIBST-TUB-B-F	341											
	Upholstered Shell	M-FIBST-TUB-B-U		597	650	681	702	719	803	719	803	828	1,101	1,101
Fiber Stool Wood Base	Fiber Shell	M-FIBST-WOD-S-F	436											
	Upholstered Shell	M-FIBST-WOD-S-U		719	755	807	828	866	933	919	933	971	1,255	1,255
Fiber Counter Stool Wood Base	Fiber Shell	M-FIBST-WOD-C-F	541											
	Upholstered Shell	M-FIBST-WOD-C-U		881	933	971	992	1,013	1,013	996	1,013	1,024	1,311	1,311
Fiber Bar Stool Wood Base	Fiber Shell	M-FIBST-WOD-B-F	541											
	Upholstered Shell	M-FIBST-WOD-B-U		881	933	971	992	1,013	1,013	996	1,013	1,024	1,311	1,311

### HOW TO CONFIGURE

### ORDER CODE EXAMPLE: Upholstered Shell

Fiber Shell	Upholstered Shell	Fiber Bar Stool with Tube Base with Castors and Gas Lift Aegean in Egret/Dusty Green
Specify: Step 1) Choose variant Step 2) Choose base color Step 3) Choose Fiber Shell color	Step 1) Choose variant Step 2) Choose base color Step 3) Choose upholstery Step 4) Choose upholstery color	Variant: Fiber Bar Stool, Wood Base Base color: Stained Dark Brown Upholstery: Hero Upholstery color: 751 Final Pattern No: MFIBSTWODBUSTDBM164751

### Base Color Options

### Shell Color Options\*

### \*When ordering Shell and Front Upholstery versions:

<p>Tube Base</p> <p>BLCK - Black WHIT - White DGRN - Dusty Green GREY - Grey</p> <p>Wood base</p> <p>OAK - Oak STDB - Stained Dark Brown BLCK - Black GREY - Grey DGRN - Dusty Green</p>	<p>BLCK - Anthracite Black GREY - Grey DGRN - Dusty Green OCHR - Ochre WHIT - Natural White</p>	<p>Base and Shell can be combined as follows</p> <p>Tube Base</p> <p>BLCK/BLCK - Black/Black Shell GREY/GREY - Grey/Grey Shell WHIT/WHIT - White/Natural White Shell DGRN/DGRN - Dusty Green/Dusty Green BLCK/OCHR - Black/Ochre Shell</p> <p>Wood base</p> <p>BLCK/BLCK - Black/Black Shell GREY/GREY - Grey/Grey Shell OAK/WHIT - Oak/Natural White Shell DGRN/DGRN - Dusty Green/Dusty Green OAK/OCHR - Oak/Ochre Shell STDB/(all colors) - Stained Dark Brown/(Choose any of the shell colors)</p> <p>All other combinations are available as specials with a 5% upcharge via dealer portal.</p>
--	---	--

### Upholstery Options

A	B	C	E	G	H	R	T	U	V	W
Ocean (M161)* Remix (M156) Wooly (M159)	Cameo (K1443) Canvas (M153) Clara (M154) Fiord (M155) Grain (M12659) Knoll Hopsack (K1206) Manner (M12665) Prairie (K1925) Re-Wool (M4586) Sabi (M8404) Steelcut (M149) Steelcut Quartet (M13042) Steelcut Trio (M139) Vibe II (K2154)	Hallingdal (M146)	Acca (M12660) Aegean (K2074) Balder (M152) Beck (M6376) Divina (M150) Divina MD (M147) Divina Melange (M135) Ecriture (M10767) Hearth (M12664) Twill Weave (M142) Vidar (M158)	Modern Tweed (K2155)	Stretch Appeal (K2188)	Easy Leather (M141)	Refine Leather (M136)	Endure Leather (M137) Volo Leather (VO)	Grace Leather (M12374)	Allure Leather (M12375)

\*Notes:  
Ocean - Color 3, 21, 32, 50, 52, 80 & 601

# FIBER STOOL W. BACKREST

## All Variants

			Upholstery Grades										
			COM			CIL			COL				
Description	Pattern No.	Fiber Shell	A	B	C	E	G	H	R	T	U	V	W
<b>Fiber Counter Stool Tube Base w. Backrest</b>	Fiber Shell	M-FIBST-TUB-CB-F	383										
	Upholstered Shell	M-FIBST-TUB-CB-U	681	755	807	828	866	1,013	933	1,013	1,024	1,311	1,311
<b>Fiber Bar Stool Tube Base w. Backrest</b>	Fiber Shell	M-FIBST-TUB-BB-F	383										
	Upholstered Shell	M-FIBST-TUB-BB-U	681	755	807	828	866	1,013	933	1,013	1,024	1,311	1,311
<b>Fiber Counter Stool Wood Base w. Backrest</b>	Fiber Shell	M-FIBST-WOD-CB-F	576										
	Upholstered Shell	M-FIBST-WOD-CB-U	971	1,045	1,101	1,150	1,150	1,206	1,150	1,206	1,255	1,570	1,570
<b>Fiber Bar Stool Wood Base w. Backrest</b>	Fiber Shell	M-FIBST-WOD-BB-F	576										
	Upholstered Shell	M-FIBST-WOD-BB-U	971	1,045	1,101	1,150	1,150	1,206	1,150	1,206	1,255	1,570	1,570

## HOW TO CONFIGURE

### ORDER CODE EXAMPLE: Upholstered Shell

Fiber Shell	Upholstered Shell	Fiber Bar Stool wood base w/backrest Hero 751		
Specify: Step 1) Choose variant Step 2) Choose base color Step 3) Choose Fiber Shell color	Step 1) Choose variant Step 2) Choose base color Step 3) Choose upholstery Step 4) Choose upholstery color	Variant Base color Upholstery Upholstery color Final Pattern No:	Fiber Bar Stool wood base w/backrest Stained Dark Brown Hero 751 MFIBSTWODBUSTDBM164751	MFIBSTWODBBU STDB M164 751

### Base Color Options

Tube Base  
BLCK - Black  
WHIT - White  
DGRN - Dusty Green  
GREY - Grey

Wood base  
OAK - Oak  
STDB - Stained Dark Brown  
BLCK - Black  
GREY - Grey  
DGRN - Dusty Green

### Shell Color Options\*

BLCK - Anthracite Black  
GREY - Grey  
DGRN - Dusty Green  
OCHR - Ochre  
WHIT - Natural White

### \*When ordering Shell and Front Upholstery versions:

Base and Shell can be combined as follows  
Tube Base  
BLCK/BLCK - Black/Black Shell  
GREY/GREY - Grey/Grey Shell  
WHIT/WHIT - White/Natural White Shell  
DGRN/DGRN - Dusty Green/Dusty Green  
BLCK/OCHR - Black/Ochre Shell

Wood base  
BLCK/BLCK - Black/Black Shell  
GREY/GREY - Grey/Grey Shell  
OAK/WHIT - Oak/Natural White Shell  
DGRN/DGRN - Dusty Green/Dusty Green  
OAK/OCHR - Oak/Ochre Shell  
STDB/(all colors) - Stained Dark Brown/(Choose any of the shell colors)

All other combinations are available as specials with a 5% upcharge via dealer portal.

### Upholstery Options

A	B	C	E	G	H	R	T	U	V	W
Ocean (M161)* Remix (M156) Wooly (M159)	Cameo (K1443) Canvas (M153) Clara (M154) Fiord (M155) Grain (M12659) Knoll Hopsack (K1206) Manner (M12665) Prairie (K1925) Re-Wool (M4586) Sabi (M8404) Steelcut (M149) Steelcut Quartet (M13042) Steelcut Trio (M139) Vibe II (K2154)	Hallingdal (M146)	Acca (M12660) Aegean (K2074) Balder (M152) Beck (M6376) Divina (M150) Divina MD (M147) Divina Melange (M135) Ecriture (M10767) Hearth (M12664) Twill Weave (M142) Vidar (M158)	Modern Tweed (K2155)	Stretch Appeal (K2188)	Easy Leather (M141)	Refine Leather (M136)	Endure Leather (M137) Volo Leather (VO)	Grace Leather (M12374)	Allure Leather (M12375)

\*Notes:  
Ocean - Color 3, 21, 32, 50, 52, 80 & 601

# FIBER LOUNGE SERIES

FOR MORE INFORMATION,  
EXPLORE BELOW

- ↗ [Product Fact Sheet](#)
- ↗ [Images](#)
- ↗ [Architect Files](#)
- ↗ [Assembly Instructions](#)
- ↗ [Product Declaration](#)
- ↗ [Product Configurator](#)



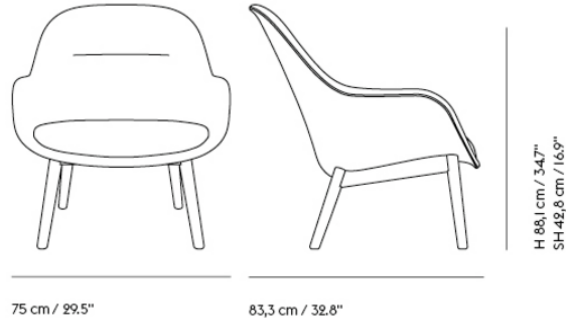

Shipper Colli	1
Gross Weight (kg)	22
Net Weight (kg)	17
Base color options	Anthracite Black, Dusty Green, Oak, Grey, Stained Dark Brown
Warranty Period	10 years

Pattern No.	Color	Contract Price	Lead Time
<b>Ready-To-Ship US Warehouse</b>			
MFIBLACWODU-OAK-M10767240	Ecriture 240/Oak	USD 2,830.00	-
MFIBLACWODU-BLCK-M136COGN	Refine Leather Cognac/Anthracite Black	USD 3,355.00	-
<b>Extras</b>			
MGLDFWDFB4	Felt Glides for Fiber Wood Base (4 pcs per pack) - Black	USD 21.00	-
MGLDFWDFG4	Felt Glides for Fiber Wood Base (4 pcs per pack) - Grey	USD 21.00	-
MLEAKIT	Leather care set for Refine Leather	USD 27.00	-

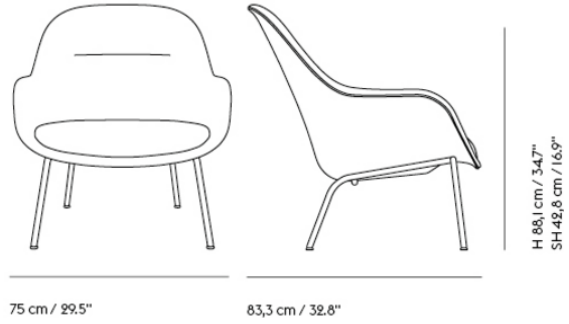

Shipper Colli	1
Gross Weight (kg)	22
Net Weight (kg)	17
Base color options	Anthracite Black, Dusty Green, Grey
Warranty Period	10 years

Pattern No.	Color	Contract Price	Lead Time
<b>Ready-To-Ship US Warehouse</b>			
MFIBLACTUBU-GREY-M10767240	Ecriture 240/Grey	USD 2,571.00	-
MFIBLACTUBU-BLCK-M136COGN	Refine Leather Cognac/Anthracite Black	USD 3,096.00	-
<b>Extras</b>			
MGLDOFVTBFB4	Felt Glides for Oslo and Fiber with Tube Base (4 pcs per pack)	USD 21.00	-
MLEAKIT	Leather care set for Refine Leather	USD 27.00	-



<b>Shipper Colli</b>	1
<b>Gross Weight (kg)</b>	11.5
<b>Net Weight (kg)</b>	8
<b>Base color options</b>	Anthracite Black, Dusty Green, Grey, Oak or Stained Dark Brown
<b>Warranty Period</b>	10 years

Pattern No.	Color	Contract Price	Lead Time
<b>Ready-To-Ship US Warehouse</b>			
MFIBLWODF-BLCK-BLCK	Black/Anthracite Black ***	USD 803.00	-
MFIBLWODF-OAK-WHIT	Natural White/Oak ***	USD 803.00	-
MFIBLWODU-OAK-M139236	Steelcut Trio 236/Oak	USD 1,465.00	-
<b>Ready-To-Ship EU Warehouse</b>			
MFIBLWODU-GREY-M156133	Remix 133/Grey	USD 1,360.00	-
<b>Extras</b>			
MGLDFWDFB4	Felt Glides for Fiber Wood Base (4 pcs per pack) - Black	USD 21.00	-
MGLDFWDFG4	Felt Glides for Fiber Wood Base (4 pcs per pack) - Grey	USD 21.00	-
MLEAKIT	Leather care set for Refine Leather	USD 27.00	-

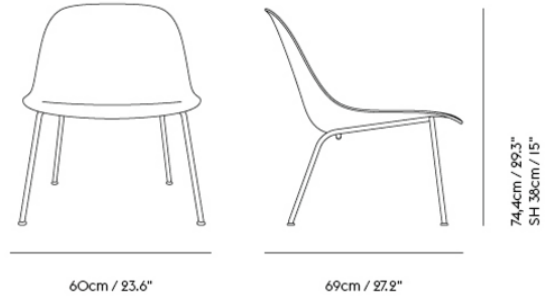

Shipper Colli	1
Gross Weight (kg)	11.5
Net Weight (kg)	8
Base color options	Anthracite Black, Dusty Green, Grey or White
Warranty Period	10 years

Pattern No.	Color	Contract Price	Lead Time
<b>Ready-To-Ship US Warehouse</b>			
MFIBLTUBF-WHIT-WHIT	Natural White/White	USD 597.00	-
MFIBLTUBU-BLCK-M139236	Steelcut Trio 236/Anthracite Black	USD 1,311.00	-
<b>Ready-To-Ship EU Warehouse</b>			
MFIBLTUBU-GREY-M156133	Remix I33/Grey	USD 1,150.00	-
MFIBLTUBU-BLCK-M150154	Divina I54/Anthracite Black ***	USD 1,416.00	-
<b>Extras</b>			
MGLDOFVTBPB1	Plastic glides for Oslo and Fiber with Tube Base (1 pc per pack) - Black	USD 6.00	-
MGLDOFVTBFB4	Felt Glides for Oslo and Fiber with Tube Base (4 pcs per pack)	USD 21.00	-
MLEAKIT	Leather care set for Refine Leather	USD 27.00	-

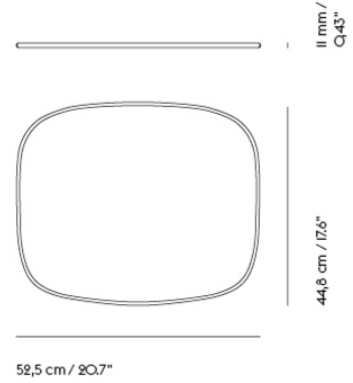

Shipper Colli 1  
 Gross Weight (kg) 0.45  
 Net Weight (kg) 0.35  
 Warranty Period 5 years

Pattern No.	Color	Contract Price	Lead Time
<b>Ready-To-Ship EU Warehouse</b>			
MFIBLGPAD-M156133	Remix I33	USD 100.00	-
MFIBLGPAD-M141BLCK	Easy Leather Black	USD 121.00	-

# FIBER LOUNGE ARMCHAIR



FIBER LOUNGE ARMCHAIR - TUBE BASE

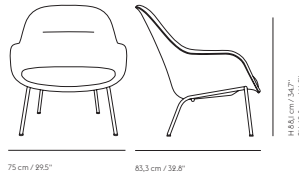

Tube Base  
 Shipper Colli: 1  
 Gross Weight (kg): 22  
 Net Weight (kg): 17  
 Warranty Period: 10 years

FIBER LOUNGE ARMCHAIR - WOOD BASE

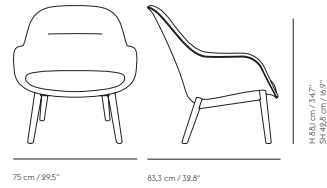

Wood Base  
 Shipper Colli: 1  
 Gross Weight (kg): 22  
 Net Weight (kg): 17  
 Warranty Period: 10 years

## All Variants

All Variants	Description	Pattern No.	Upholstery Grades								
			A	B	COM	CIL	R	T	COL		
					C	E			U	V	W
Fiber Lounge Armchair Wood Base	Upholstered Shell	MFIBLACWODU	2,046	2,305	2,410	2,571	2,935	3,096	3,201	3,355	3,516
Fiber Lounge Armchair Tube	Upholstered Shell	MFIBLACTUBU	2,305	2,571	2,676	2,830	3,201	3,355	3,516	3,621	3,775

## HOW TO CONFIGURE

ORDER CODE EXAMPLE: Upholstered Shell

### Upholstered Shell

Fiber Lounge Armchair Wood Base Ocean 80

- Step 1) Choose variant
- Step 2) Choose base color
- Step 3) Choose upholstery
- Step 4) Choose upholstery color

Variant: Fiber Lounge Armchair Wood Base - Upholstered  
 Base color: Oak OAK  
 Upholstery: Ocean M161  
 Upholstery color: 80  
 Final Pattern No: MFIBLACWODU-OAK-M16180

## BASE COLOR OPTIONS

Tube Base:  
 BLCK - Black  
 GREY - Grey  
 DGRN - Dusty Green

Wood base:  
 OAK - Oak  
 STDB - Stained Dark Brown  
 BLCK - Black  
 GREY - Grey

## Upholstery Options

A	B	C	E	R	T	U	V	W
Ocean (M161)*	Canvas (M153)	Hallingdal (M146)	Acca (M12660)	Easy Leather (M141)	Refine Leather (M136)	Endure Leather (M137)	Grace Leather (M12374)	Allure Leather (M12375)
Remix (M156)	Clara (M154)		Balder (M152)					
Wooly (M159)	Grain (M12659)		Beck (M6376)					
	Manner (M12665))		Divina (M150)					
	Re-Wool (M4586)		Divina MD (M147)					
	Sabi (M8404)		Divina Melange (M135)					
	Steelcut (M149)		Ecriture (M10767)					
	Steelcut Quartet (M13042)		Hearth (M12664)					
	Steelcut Trio (M139)		Twill Weave (M142)					
			Vidar (M158)					

\*Notes:  
 Ocean - Color 3, 21, 32, 50, 52, 80 & 601

# FIBER LOUNGE CHAIR



## All Variants

### Contract Price

Description	Pattern No.	Fiber Shell	Upholstery Grades											
			COM			CIL			COL					
			A	B	C	E	G	H	R	T	U	V	W	
<b>Fiber Lounge Tube Base</b>	Fiber Shell	M-FIBL-TUB-F	597											
	Upholstered Shell	M-FIBL-TUB-U		1,150	1,311	1,416	1,416	1,416	1,836	1,731	1,836	1,941	2,410	2,620
<b>Fiber Lounge Wood Base</b>	Fiber Shell	M-FIBL-WOD-F	803											
	Upholstered Shell	M-FIBL-WOD-U		1,360	1,465	1,570	1,626	1,626	2,095	1,941	2,095	2,305	2,830	2,935

## HOW TO CONFIGURE

### ORDER CODE EXAMPLE: Upholstered Shell

<b>Fiber Shell</b>	<b>Upholstered Shell</b>	<b>Fiber Lounge Chair Wood Base Endure Olive / Black base</b>		
Specify: Step 1) Choose variant Step 2) Choose base color Step 3) Choose Fiber Shell color	Step 1) Choose variant Step 2) Choose base color Step 3) Choose upholstery Step 4) Choose upholstery color	Variant Base color Upholstery Upholstery color Final Pattern No:	Fiber Lounge Chair Wood Base - Upholstered Black Endure Olive MFIBLWODUBLCKM137OLVE	MFIBLWODU BLCK M137 OLVE

### Base Color Options

### Shell Color Options\*

### \*When ordering Shell and Front Upholstery versions:

Tube Base:  
BLCK - Black  
WHIT - White  
DGRN - Dusty Green  
GREY - Grey

BLCK - Black  
GREY - Grey  
DGRN - Dusty Green  
OCHR - Ochre  
WHIT - Natural White

Base and Shell can be combined as follows  
Tube Base:  
BLCK/BLCK - Black/Black Shell  
GREY/GREY - Grey/Grey Shell  
WHIT/WHIT - White/Natural White Shell  
BLCK/OCHR - Black/Ochre Shell

Wood base:  
OAK - Oak  
STDB - Stained Dark Brown  
BLCK - Black  
GREY - Grey  
DGRN - Dusty Green

Wood base:  
BLCK/BLCK - Black/Black Shell  
GREY/GREY - Grey/Grey Shell  
OAK/WHIT - Oak/Natural White Shell  
OAK/OCHR - Oak/Ochre Shell  
STDB/(all colors) - Stained Dark Brown/(Choose any of the shell colors)

All other combinations are available as specials with a 5% upcharge via dealer portal.

### Upholstery Options

A	B	C	E	G	H	R	T	U	V	W
Ocean (M161)* Remix (M156) Wooly (M159)	Cameo (K1443) Canvas (M153) Clara (M154) Fiord (M155) Grain (M12659) Knoll Hopsack (K1206) Manner (M12665) Prairie (K1925) Re-Wool (M4586) Sabi (M8404) Steelcut (M149) Steelcut Quartet (M13042) Steelcut Trio (M139) Vibe II (K2154)	Hallingdal (M146)	Acca (M12660) Aegean (K2074) Balder (M152) Beck (M6376) Divina (M150) Divina MD (M147) Divina Melange (M135) Ecriture (M10767) Hearth (M12664) Twill Weave (M142) Vidar (M158)	Modern Tweed (K2155)	Stretch Appeal (K2188)	Easy Leather (M141)	Refine Leather (M136)	Endure Leather (M137) Volo Leather (VO)	Grace Leather (M12374)	Allure Leather (M12375)

\*Notes:  
Ocean - Color 3, 21, 32, 50, 52, 80 & 601

# FIBER SOFT SERIES

**FOR MORE INFORMATION,  
EXPLORE BELOW**

- ↗ [Product Fact Sheet](#)
- ↗ [Images](#)
- ↗ [Architect Files](#)
- ↗ [Assembly Instructions](#)
- ↗ [Product Declaration](#)
- ↗ [Product Configurator](#)



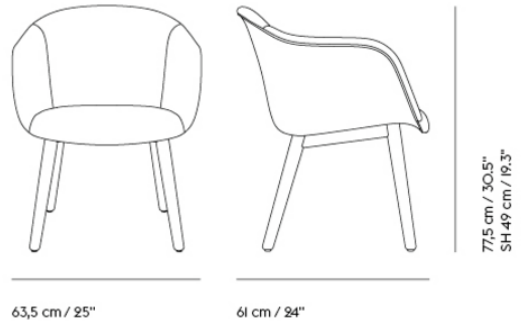

**Gross Weight (kg)** 15.632  
**Net Weight (kg)** 12.132  
**Base color options** Oak, Stained Dark Brown, Anthracite Black or Grey  
**Warranty period** 10 years

Pattern No.	Color	Contract Price	Lead Time
<b>Ready-To-Ship EU Warehouse</b>			
MFIBSOFAWODU-OAK-M10767240	Ecriture 24O/Oak	USD 1,626.00	-
<b>Extras</b>			
MGLDFWDFB4	Felt Glides for Fiber Wood Base (4 pcs per pack) - Black	USD 21.00	-
MGLDFWDFG4	Felt Glides for Fiber Wood Base (4 pcs per pack) - Grey	USD 21.00	-
MLEAKIT	Leather care set for Refine Leather	USD 27.00	-

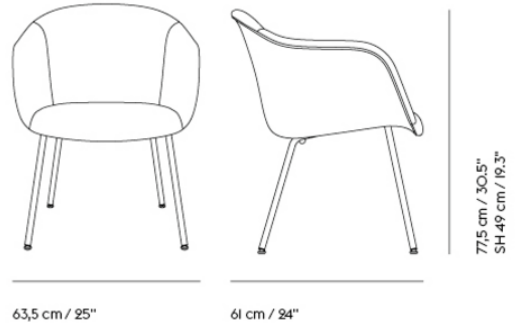

Gross Weight (kg) 15.117  
 Net Weight (kg) 19.5  
 Base color options Anthracite Black or Grey  
 Warranty period 10 years

Pattern No.	Color	Contract Price	Lead Time
<b>Ready-To-Ship US Warehouse</b>			
MFIBSOFATUBU-GREY-M10767240	Ecriture 240/Grey	USD 1,465.00	-
<b>Extras</b>			
MGLDOFVTBFB4	Felt Glides for Oslo and Fiber with Tube Base (4 pcs per pack)	USD 21.00	-
MLEAKIT	Leather care set for Refine Leather	USD 27.00	-



Gross Weight (kg) 17.305  
 Net Weight (kg) 13.805  
 Base color options Anthracite Black or Grey  
 Warranty period 10 years

Pattern No.	Color	Contract Price	Lead Time
<b>Ready-To-Ship US Warehouse</b>			
MFIBSOFASWBU-GREY-M10767240	Ecriture 240/Grey	USD 1,626.00	-
<b>Extras</b>			
MGLDFVSWFB4	Felt Glides for Fiber and Visu with Swivel Base (4 pcs per pack)	USD 21.00	-
MLEAKIT	Leather care set for Refine Leather	USD 27.00	-



Swivel Base & w. Return

Shipper Colli 1	1
Gross Weight (Kg)	19.5
Warranty period	10 years

Swivel Base w. Return & Tilt

Shipper Colli 1	1
Gross Weight (Kg)	19.5
Warranty period	10 years

Swivel Base w. Castors

Shipper Colli 1	1
Gross Weight (Kg)	19.5
Warranty period	10 years

Swivel Base w. Castors & Tilt

Shipper Colli 1	1
Gross Weight (Kg)	19.5
Warranty period	10 years

Swivel Base w. Gas Lift, Castors, and Tilt

Shipper Colli 1	1
Gross Weight (Kg)	19.5
Warranty period	10 years

All Variants

FIBER SOFT - SWIVEL BASE



77.5 cm / 30.5"  
SH 49cm / 19.3"

FIBER SOFT - SWIVEL BASE W. RETURN



77.5 cm / 30.5"  
SH 49cm / 19.3"

FIBER SOFT - SWIVEL BASE W. RETURN & TILT



77.5 cm / 30.5"  
SH 49cm / 19.3"

FIBER SOFT - SWIVEL BASE W. CASTORS



77.5 cm / 30.5"  
SH 49cm / 19.3"

FIBER SOFT - SWIVEL BASE W. CASTORS AND TILT



77.5 cm / 30.5"  
SH 49cm / 19.3"

FIBER SOFT - SWIVEL BASE W. CASTORS AND TILT AND GASLIFT



73.85 cm / 28.9-33.5"  
SH 45-57cm / 17.6-22.22"

# FIBER SOFT ARMCHAIR SWIVEL BASE

## All Variants

All Variants	Description	Pattern No.	Upholstery Grades								
			A	B	CIL	E	R	T	COL		
					C				U	V	W
Fiber Soft Armchair Swivel Base	Upholstered Shell	MFIBSOFASWBU	1,311	1,465	1,626	1,626	1,941	2,046	2,095	2,410	2,571
Fiber Soft Armchair Swivel Base w. Return	Upholstered Shell	MFIBSOFASWRU	1,360	1,521	1,626	1,675	1,990	2,095	2,151	2,515	2,620
Fiber Soft Armchair Swivel Base w. Return & Tilt	Upholstered Shell	MFIBSOFASWTU	1,416	1,570	1,626	1,731	2,095	2,151	2,256	2,571	2,676
Fiber Soft Armchair Swivel Base w. Castors	Upholstered Shell	MFIBSOFASWCU	1,311	1,465	1,626	1,675	1,941	2,095	2,151	2,515	2,620
Fiber Soft Armchair Swivel Base w. Castors & Tilt	Upholstered Shell	MFIBSOFASWCTU	1,416	1,626	1,731	1,731	2,095	2,151	2,256	2,571	2,676
Fiber Soft Armchair Swivel Base w. Castors & Gas Lift, and Tilt	Upholstered Shell	MFIBSOFASWGTU	1,465	1,675	1,731	1,836	2,095	2,256	2,305	2,620	2,781

### HOW TO CONFIGURE

ORDER CODE EXAMPLE: Upholstered Shell

Upholstered Shell

- Step 1) Choose variant
- Step 2) Choose base color
- Step 3) Choose upholstery
- Step 4) Choose upholstery color

Fiber Soft Armchair Swivel Base with Castors, Gas Lift, and Tilt in Twill Weave 230

Variant  
Base color  
Upholstery  
Upholstery color  
Final Pattern No:

Castors, Gaslift, & Tilt - upholstered  
Anthracite Black  
Twill Weave  
230  
MFIBSOFASWGTUBLCKM142230

### Base Color Options

- BLCK - Anthracite Black
- GREY - Grey

### Upholstery Options

A	B	C	E	R	T	U	V	W
Ocean (M161)* Remix (M156) Wooly (M159)	Cameo (K1443) Canvas (M153) Clara (M154) Fiord (M155) Grain (M12659) Knoll Hopsack (K1206) Manner (M12665) Prairie (K1925) Re-Wool (M4586) Sabi (M8404) Steelcut (M149) Steelcut Quartet (M13042) Steelcut Trio (M139) Vibe II (K2154)	Hallingdal (M146)	Acca (M12660) Aegean (K2074) Balder (M152) Beck (M6376) Divina (M150) Divina MD (M147) Divina Melange (M135) Ecriture (M10767) Hearth (M12664) Twill Weave (M142) Vidar (M158)	Easy Leather (M141)	Refine Leather (M136)	Endure Leather (M137) Volo Leather (VO)	Grace Leather (M12374)	Allure Leather (M12375)

\*Notes:  
Ocean - Color 3, 21, 32, 50, 52, 80 & 601

# FIBER SOFT ARMCHAIR WOOD & TUBE BASE



FIBER SOFT - TUBE BASE



Tube Base  
 Shipper Colli: 1  
 Gross Weight (kg): 22.9  
 Net Weight (kg): 19.5  
 Warranty Period: 10 years

FIBER SOFT - WOOD BASE

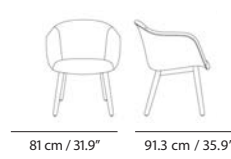

Wood Base  
 Shipper Colli: 1  
 Gross Weight (kg): 22.9  
 Net Weight (kg): 19.5  
 Warranty Period: 10 years

## All Variants

All Variants	Description	Pattern No.	Upholstery Grades		COM		CIL		COL		
			A	B	C	E	R	T	U	V	W
Fiber Soft Armchair Wood Base	Upholstered Shell	MFIBSOFAWODU	1,311	1,465	1,570	1,626	1,941	2,046	2,095	2,466	2,466
Fiber Soft Armchair Tube Base	Upholstered Shell	MFIBSOFATUBU	1,206	1,360	1,465	1,465	1,885	1,941	1,990	2,410	2,410

## HOW TO CONFIGURE

ORDER CODE EXAMPLE: Upholstered Shell

### Upholstered Shell

Fiber Soft Armchair Wood Base Ocean 80

- Step 1) Choose variant
- Step 2) Choose base color
- Step 3) Choose upholstery
- Step 4) Choose upholstery color

Variant: Fiber Soft Armchair Wood Base - Upholstered Oak  
 Base color: Ocean OAK  
 Upholstery: 80 M161  
 Upholstery color: MFIBSOFAWODU-OAK-M16180  
 Final Pattern No: 80

## BASE COLOR OPTIONS

Tube Base:  
 BLCK - Black

GREY - Grey

Wood base:  
 OAK - Oak  
 STDB - Stained Dark Brown  
 BLCK - Black  
 GREY - Grey

## Upholstery Options

A	B	C	E	R	T	U	V	W
Ocean (M161)*	Cameo (K1443)	Hallingdal (M146)	Acca (M12660)	Easy Leather (M141)	Refine Leather (M136)	Endure Leather (M137)	Grace Leather (M12374)	Allure Leather (M12375)
Remix (M156)	Canvas (M153)		Aegean (K2074)			Volo Leather (VO)		
Wooly (M159)	Clara (M154)		Balder (M152)					
	Fiord (M155)		Beck (M6376)					
	Grain (M12659)		Divina (M150)					
	Knoll Hopsack (K1206)		Divina MD (M147)					
	Manner (M12665)		Divina Melange (M135)					
	Prairie (K1925)		Ecriture (M10767)					
	Re-Wool (M4586)		Hearth (M12664)					
	Sabi (M8404)		Twill Weave (M142)					
	Steelcut (M149)		Vidar (M158)					
	Steelcut Quartet (M13042)							
	Steelcut Trio (M1139)							
	Vibe II (K2154)							

\*Notes:  
 Ocean - Color 3, 21, 32, 50, 52, 80 & 601

# FIBER CONFERENCE SERIES

FOR MORE INFORMATION,  
EXPLORE BELOW

- ↗ [Product Fact Sheet](#)
- ↗ [Images](#)
- ↗ [Architect Files](#)
- ↗ [Assembly Instructions](#)
- ↗ [Product Declaration](#)
- ↗ [Product Configurator](#)

# FIBER CONFERENCE ARMCHAIR WOOD BASE



63,5 cm / 25"



61 cm / 24"

77,5 cm / 30.5"  
SH: 49 cm / 19.3"

<b>Shipper Colli</b>	1
<b>Gross Weight (kg)</b>	15.63
<b>Net Weight (kg)</b>	12.132
<b>Base color options</b>	Anthracite Black, Grey, Oak and Stained Dark Brown
<b>Warranty Period</b>	10 years

Pattern No.	Color	Contract Price	Lead Time
<b>Ready-To-Ship US Warehouse</b>			
MFIBCWODU-GREY-M156133	Remix 133/Grey	USD 1,311.00	-
MFIBCWODU-OAK-M136COGN	Refine Leather Cognac/Oak	USD 2,046.00	-
<b>Extras</b>			
MLEAKIT	Leather care set for Refine Leather	USD 27.00	-



# FIBER CONFERENCE ARMCHAIR SWIVEL BASE



63,5 cm / 25"



60,5 cm / 23.8"

77,5 cm / 30.5"  
SH 49 cm / 19.3"

Shipper Colli	1
Gross Weight (kg)	17.31
Net Weight (kg)	13.805
Base color options	Anthracite Black or Grey
Warranty period	10 years

Pattern No.	Color	Contract Price	Lead Time
<b>Ready-To-Ship US Warehouse</b>			
MFIBCSWBU-GREY-M156133	Remix I33/Grey	USD 1,311.00	-
MFIBCSWBU-BLCK-M136COGN	Refine Leather Cognac/Anthracite Black	USD 2,046.00	-
<b>Extras</b>			
MGLDFVSWFB4	Felt Glides for Fiber and Visu with Swivel Base (4 pcs per pack)	USD 21.00	-
MLEAKIT	Leather care set for Refine Leather	USD 27.00	-

# FIBER CONFERENCE ARMCHAIR SWIVEL BASE W. GAS LIFT, CASTORS AND TILT

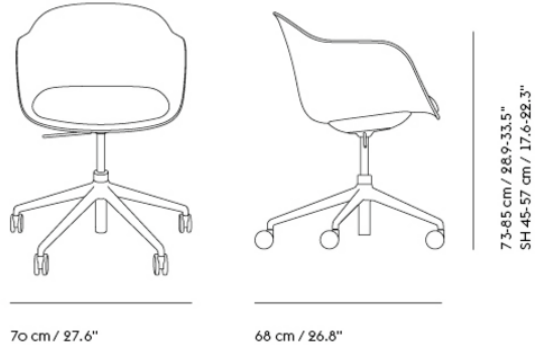

Shipper Colli	1
Gross Weight (kg)	18.78
Net Weight (kg)	15.28
Base color options	Anthracite Black or Grey
Warranty period	10 years

Pattern No.	Color	Contract Price	Lead Time
<b>Ready-To-Ship US Warehouse</b>			
MFIBCSWGTU-GREY-M156133	Remix I33/Grey	USD 1,521.00	-
MFIBCSWGTU-BLCK-M136COGN	Refine Leather Cognac/Anthracite Black	USD 2,256.00	-
<b>Extras</b>			
MLEAKIT	Leather care set for Refine Leather	USD 27.00	-



Swivel Base & w. Return

Shipper Colli 1 1  
Gross Weight (Kg) 19.5  
Warranty period 10 years

Swivel Base w. Return & Tilt

Shipper Colli 1 1  
Gross Weight (Kg) 19.5  
Warranty period 10 years

Swivel Base w. Castors

Shipper Colli 1 1  
Gross Weight (Kg) 19.5  
Warranty period 10 years

Swivel Base w. Castors & Tilt

Shipper Colli 1 1  
Gross Weight (Kg) 19.5  
Warranty period 10 years

Swivel Base w. Gas Lift, Castors, and Tilt

Shipper Colli 1 1  
Gross Weight (Kg) 19.5  
Warranty period 10 years

All Variants

FIBER CONFERENCE - SWIVEL BASE

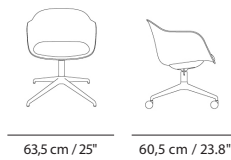

77.5 cm / 30.5\"/>

FIBER CONFERENCE - SWIVEL BASE W. RETURN

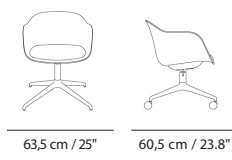

77.5 cm / 30.5\"/>

FIBER CONFERENCE - SWIVEL BASE W. RETURN & TILT

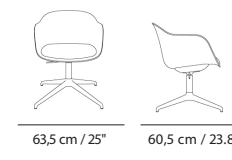

77.5 cm / 30.5\"/>

FIBER CONFERENCE - SWIVEL BASE W. CASTORS

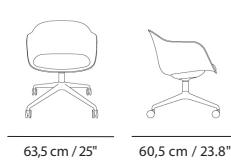

77.5 cm / 30.5\"/>

FIBER CONFERENCE - SWIVEL BASE W. CASTORS AND TILT

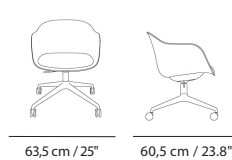

77.5 cm / 30.5\"/>

FIBER CONFERENCE - SWIVEL BASE W. CASTORS AND TILT AND GASLIFT

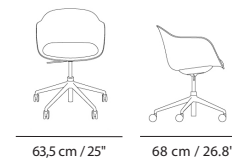

73.85 cm / 28.9-33.5\"/>

# FIBER CONFERENCE ARMCHAIR SWIVEL BASE

## All Variants

All Variants	Description	Pattern No.	Upholstery Grades		COM						
			A	B	C	E	R	T	U	V	W
Fiber Conference Armchair Swivel Base	Upholstered Shell	MFIBCSWBU	1,311	1,465	1,626	1,626	1,941	2,046	2,095	2,410	2,571
Fiber Conference Armchair Swivel Base w. Return	Upholstered Shell	MFIBCSWRU	1,360	1,521	1,626	1,675	1,990	2,095	2,151	2,515	2,620
Fiber Conference Armchair Swivel Base w. Return & Tilt	Upholstered Shell	MFIBCSWTU	1,465	1,626	1,570	1,780	2,095	2,200	2,256	2,571	2,781
Fiber Conference Armchair Swivel Base w. Castors	Upholstered Shell	MFIBCSWCU	1,360	1,521	1,626	1,675	1,990	2,095	2,151	2,515	2,620
Fiber Conference Armchair Swivel Base w. Castors & Tilt	Upholstered Shell	MFIBCSWCTU	1,465	1,626	1,731	1,780	2,095	2,200	2,256	2,571	2,781
Fiber Conference Armchair Swivel Base w. Castors & Gas Lift, and Tilt	Upholstered Shell	MFIBCSWGTU	1,521	1,675	1,731	1,836	2,151	2,256	2,305	2,620	2,781

### HOW TO CONFIGURE

ORDER CODE EXAMPLE: Upholstered Shell

#### Upholstered Shell

- Step 1) Choose variant
- Step 2) Choose base color
- Step 3) Choose upholstery
- Step 4) Choose upholstery color

Fiber Conference Armchair Swivel Base with Castors, Gas Lift, and Tilt in Twill Weave 230

Variant  
 Base color  
 Upholstery  
 Upholstery color  
 Final Pattern No:

Castors, Gaslift, & Tilt - upholstered  
 Anthracite Black  
 Twill Weave  
 230  
 MFIBCSWGTUBLCKM142230

#### Base Color Options

- BLCK - Anthracite Black
- GREY - Grey

#### Upholstery Options

A	B	C	E	R	T	U	V	W
Ocean (M161)*	Cameo (K1443)	Hallingdal (M146)	Acca (M12660)	Easy Leather (M141)	Refine Leather (M136)	Endure Leather (M137)	Grace Leather (M12374)	Allure Leather (M12375)
Remix (M156)	Canvas (M153)		Aegean (K2074)			Volo Leather (VO)		
Wooly (M159)	Clara (M154)		Balder (M152)					
	Fiord (M155)		Beck (M6376)					
	Grain (M12659)		Divina (M150)					
	Knoll Hopsack (K1206)		Divina MD (M147)					
	Manner (M12665)		Divina Melange (M135)					
	Prairie (K1925)		Ecriture (M10767)					
	Re-Wool (M4586)		Hearth (M12664)					
	Sabi (M8404)		Twill Weave (M142)					
	Steelcut (M149)		Vidar (M158)					
	Steelcut Quartet (M13042)							
	Steelcut Trio (M139)							
	Vibe II (K2154)							

\*Notes:  
 Ocean - Color 3, 21, 32, 50, 52, 80 & 601

# FIBER CONFERENCE ARMCHAIR WOOD & TUBE BASE



FIBER CONFERENCE -  
TUBE BASE



81 cm / 31.9"

91.3 cm / 35.9"

91 cm /  
35.8"  
SH 44.5 cm /  
17.5"

Tube Base  
Shipper Colli: 1  
Gross Weight (kg): 22.9  
Net Weight (kg): 19.5  
Warranty Period: 10 years

FIBER CONFERENCE -  
WOOD BASE



81 cm / 31.9"

91.3 cm / 35.9"

91 cm /  
35.8"  
SH 44.5 cm /  
17.5"

Wood Base  
Shipper Colli: 1  
Gross Weight (kg): 22.9  
Net Weight (kg): 19.5  
Warranty Period: 10 years

## All Variants

All Variants	Description	Pattern No.	Upholstery Grades		COM C	CIL E	R	T	COL		
			A	B					U	V	W
Fiber Conference Armchair Wood Base	Upholstered Shell	MFIBCWODU	1,311	1,465	1,570	1,626	1,941	2,046	2,095	2,410	2,571
Fiber Conference Armchair Tube Base	Upholstered Shell	MFIBCTUBU	1,206	1,360	1,465	1,465	1,885	1,941	1,990	2,361	2,515

## HOW TO CONFIGURE

ORDER CODE EXAMPLE: Upholstered Shell

### Upholstered Shell

Fiber Conference Armchair Wood Base Ocean 80

- Step 1) Choose variant  
Step 2) Choose base color  
Step 3) Choose upholstery  
Step 4) Choose upholstery color

Variant  
Base color  
Upholstery  
Upholstery color  
Final Pattern No:

Fiber Conference Armchair Wood Base - Upholstered  
Oak  
Ocean  
80  
MFIBCWODU-OAK-M16180

OAK  
M161  
80

## BASE COLOR OPTIONS

Tube Base:  
BLCK - Black

GREY - Grey

Wood base:  
OAK - Oak  
STDB - Stained Dark  
Brown  
BLCK - Black  
GREY - Grey

## Upholstery Options

A	B	C	E	R	T	U	V	W
Ocean (M161)* Remix (M156) Wooly (M159)	Cameo (K1443) Canvas (M153) Clara (M154) Fiord (M155) Grain (M12659) Knoll Hopsack (K1206) Manner (M12665) Prairie (K1925) Re-Wool (M4586) Sabi (M8404) Steelcut (M149) Steelcut Quartet (M13042) Steelcut Trio (M139) Vibe II (K2154)	Hallingdal (M146)	Acca (M12660) Aegean (K2074) Balder (M152) Beck (M6376) Divina (M150) Divina MD (M147) Divina Melange (M135) Ecriture (M10767) Hearth (M12664) Twill Weave (M142) Vidar (M158)	Easy Leather (M141)	Refine Leather (M136)	Endure Leather (M137) Volo Leather (VO)	Grace Leather (M12374)	Allure Leather (M12375)
							*Notes: Ocean - Color 3, 21, 32, 50, 52, 80 & 601	

# FIBER OUTDOOR SERIES

FOR MORE INFORMATION,  
EXPLORE BELOW

- ↗ [Product Fact Sheet](#)
- ↗ [Images](#)
- ↗ [Architect Files](#)
- ↗ [Product Declaration](#)

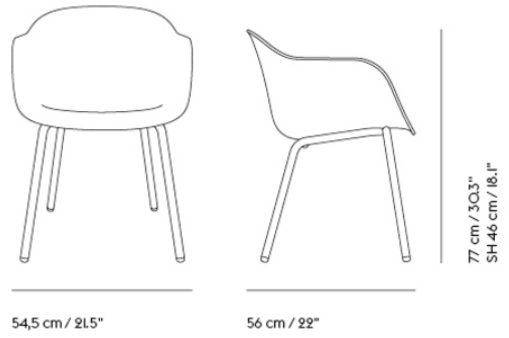

Shipper Colli 1  
 Gross Weight (kg) 5.5  
 Net Weight (kg) 6.5  
 Warranty Period 10 years

Pattern No.	Color	Contract Price	Lead Time
<b>Ready-To-Ship US Warehouse</b>			
MFIBOATUB-BLCK	Anthracite Black	USD 415.00	-
MFIBOATUB-BRRD	Brown Red	USD 415.00	-
MFIBOATUB-DGRN	Dusty Green	USD 415.00	-
MFIBOSTUB-GREY	Grey	USD 415.00	-

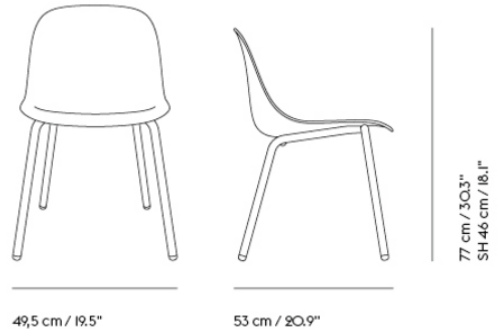

Shipper Colli |  
 Gross Weight (kg) 4.5  
 Net Weight (kg) 4.9  
 Warranty Period 10 years

Pattern No.	Color	Contract Price	Lead Time
<b>Ready-To-Ship US Warehouse</b>			
MFIBOSTUB-BLCK	Anthracite Black	USD 383.00	-
MFIBOSTUB-BRRD	Brown Red	USD 383.00	-
MFIBOSTUB-DGRN	Dusty Green	USD 383.00	-
MFIBOSTUB-GREY	Grey	USD 383.00	-



# FIVE POUF

**FOR MORE INFORMATION,  
EXPLORE BELOW**

- [↗ Product Fact Sheet](#)
- [↗ Images](#)
- [↗ Architect Files](#)
- [↗ Product Declaration](#)
- [↗ Product Configurator](#)

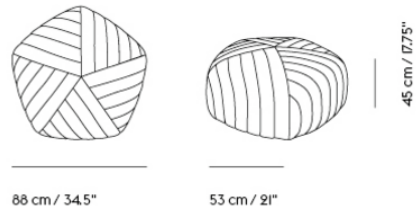
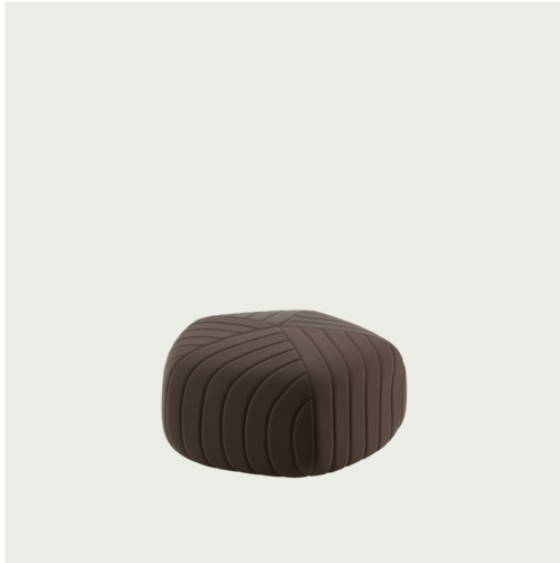

**Shipper Colli** 1  
**Gross Weight (kg)** 22  
**Net Weight (kg)** 18.8  
**Warranty Period** 10 years

Pattern No.	Color	Contract Price	Lead Time
<b>Ready-To-Ship US Warehouse</b>			
MFIVEPLG-M156123	Remix I23 ***	USD 1,570.00	-
MFIVEPLG-M156183	Remix I83 ***	USD 1,570.00	-
MFIVEPLG-M139205	Steelcut Trio 205	USD 1,836.00	-

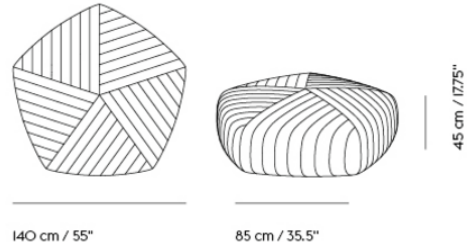

**Shipper Colli** 1  
**Gross Weight (kg)** 56  
**Net Weight (kg)** 41  
**Warranty Period** 10 years

Pattern No.	Color	Contract Price	Lead Time
<b>Ready-To-Ship US Warehouse</b>			
MFIVEPXL-M156123	Remix 123	USD 3,306.00	-
MFIVEPXL-M156183	Remix 183	USD 3,306.00	-
MFIVEPXL-M156632	Remix 632 ***	USD 3,306.00	-
MFIVEPXL-M156773	Remix 773 ***	USD 3,306.00	-
MFIVEPXL-M156933	Remix 933 ***	USD 3,306.00	-
MFIVEPXL-M139205	Steelcut Trio 205	USD 3,516.00	-



All Variants

		Upholstery Grades			
		A	COM	CIL	
Pattern No.		A	B	C	E
Large	M-FIVEP-LG	1,570	1,836	2,095	2,151
Extra Large	M-FIVEP-XL	3,306	3,516	3,831	4,146

HOWTO CONFIGURE

Five Pouf

Specify:

- Step 1) Choose Size
- Step 2) Choose textile
- Step 3) Choose textile color

ORDER CODE EXAMPLE:  
Upholstered Shell

Five Pouf XL in Remix 133

Size	Five Pouf Extra Large	MFIVEPXL
Textile	Remix	M156
Textile Color	133	133
Final Pattern No:	MFIVEPXL156133	

Upholstery Options

A	B	E
Remix (M156)	<ul style="list-style-type: none"> <li>Canvas (M153)</li> <li>Fiord (M155)</li> <li>Grain (M12659)</li> <li>Manner (M12665)</li> <li>Re-Wool (M4586)</li> <li>Sabi (M8404)</li> <li>Steelcut (M149)</li> <li>Steelcut Trio (M139)</li> </ul>	<ul style="list-style-type: none"> <li>Acca (M12660)</li> <li>Beck (M6376)</li> <li>Divina (M150)</li> <li>Divina MD (M147)</li> <li>Divina Melange (M135)</li> <li>Ecriture (M10767)</li> <li>Hearth (M12664)</li> <li>Planum (M5904)</li> <li>Twill Weave (M142)</li> </ul>

# FLOW SERIES

FOR MORE INFORMATION,  
EXPLORE BELOW

- ↗ [Product Fact Sheet](#)
- ↗ [Images](#)
- ↗ [Architect Files](#)
- ↗ [Assembly Instructions](#)
- ↗ [Product Declaration](#)

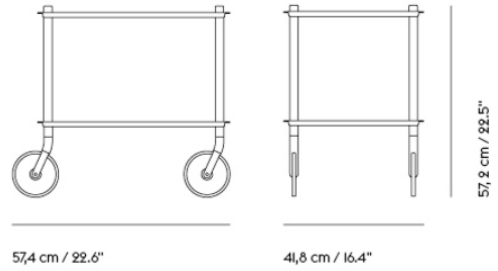

**Shipper Colli** 1  
**Gross Weight (kg)** 15.2  
**Net Weight (kg)** 12.7  
**Warranty Period** 5 years

Pattern No.	Color	Contract Price	Lead Time
<b>Ready-To-Ship US Warehouse</b>			
MFT2L-BUGY	Blue-Grey	USD 671.00	-
MFT2L-GREY	Grey	USD 671.00	-

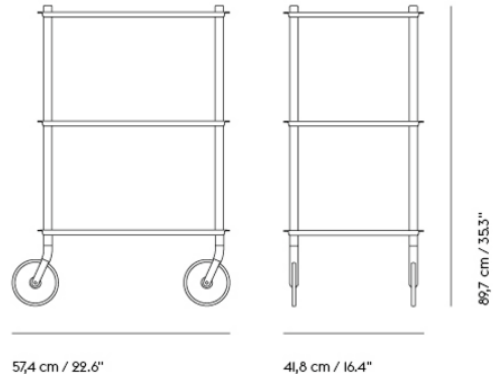

**Shipper Colli** 2  
**Gross Weight (kg)** 22.4  
**Net Weight (kg)** 18.5  
**Warranty Period** 5 years

Pattern No.	Color	Contract Price	Lead Time
<b>Ready-To-Ship US Warehouse</b>			
MFT3L-BUGY	Blue-Grey	USD 902.00	-
MFT3L-GREY	Grey	USD 902.00	-

# IN SITU MODULAR SOFA SERIES

FOR MORE INFORMATION,  
EXPLORE BELOW

- ↗ [Product Fact Sheet](#)
- ↗ [Images](#)
- ↗ [Architect Files](#)
- ↗ [Assembly Instructions](#)
- ↗ [Product Declaration](#)
- ↗ [Product Planner](#)



A grand modular sofa that can be tailored to your exact needs with its modular elements hidden through the subtle detailing of the frame's front profile, paired with deep comfort and a soft seat.

With the In Situ Modular Sofa, you can choose between any of the 30 predesigned configurations on the following pages or create your own configuration, following the guidelines below.

Visit [planner.muuto.com](http://planner.muuto.com) to create your own configuration online.

## Create your own In Situ Configuration

### 1. SEATING MODULES

Find the seating modules of your desired configuration and add the item numbers of the desired textile or leather upholstery separately to your order.

You can only connect modules to the open sides and end of the modules, illustrated here with dotted lines.

An In Situ configuration must always have one of the following seating modules at each end: Armrest Module (A80, B80, H98 or I98), Ottoman Module (D80) or Open-Ended Module (F98 or G98).

The Ottoman Module (D80) can only be used in extension of Open-Ended Modules (F98 or G98) or as the only free-standing I-Seater configuration possible to build.

### SEATING MODULES

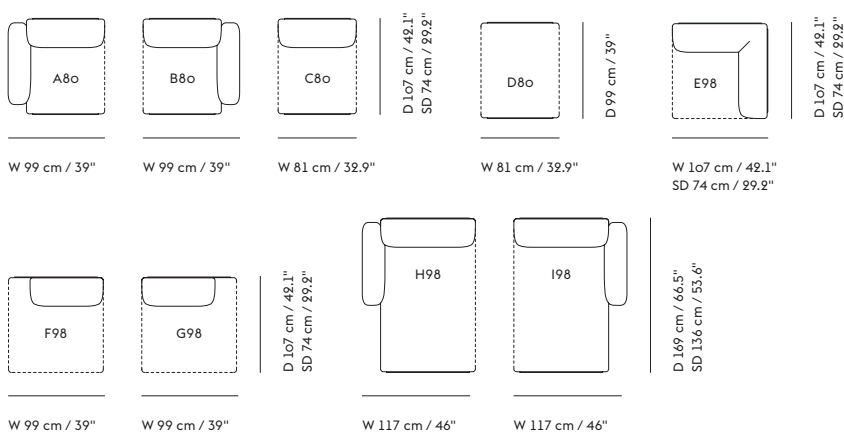

### 2. FRAME SECTIONS

Choose the frame section(s) that match the seating modules of the desired configuration (10 frame sections to choose from in total). We recommend using as few frame sections as possible when creating your own configuration for a clean appearance.

A Frame Corner Section must always be supported by sections in the two open directions.

A configuration with chaise longue modules H98 or I98 must be created using at least 2 sections in total.

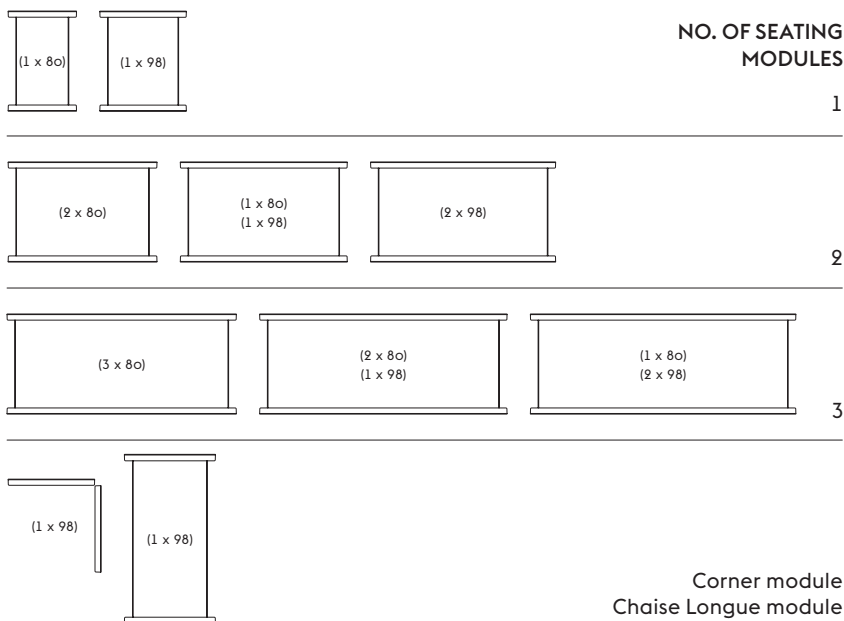

### 3. LINKING BRACKETS

Identify the amount of linking brackets required to connect the modules in your configuration, following the guidelines below. **Linking brackets must always be used when joining together frame sections.**

Linking brackets must always be mounted on the adjacent sections that face the corner section.

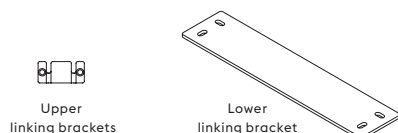

### 4. CUSHIONS

Specify optional cushions in the desired textile or leather for added comfort and a lounging expression.

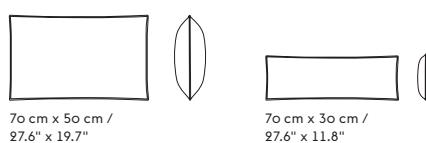

## INSPIRATION FOR YOUR CONFIGURATION

### 2-seater Configurations

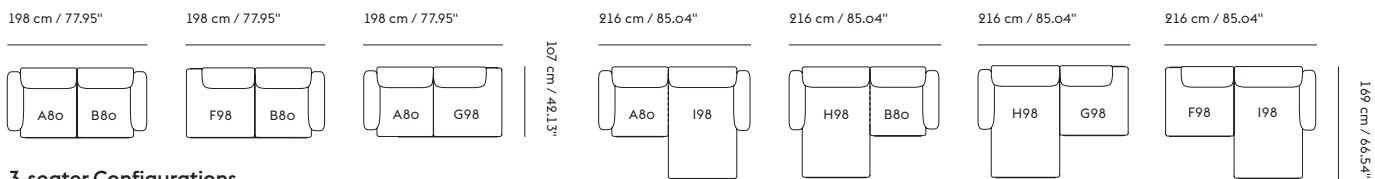

### 3-seater Configurations

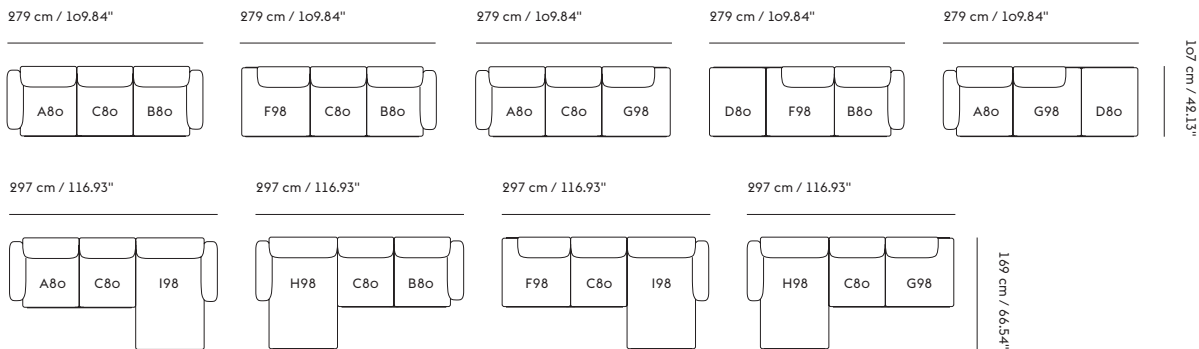

### 4-seater Configurations

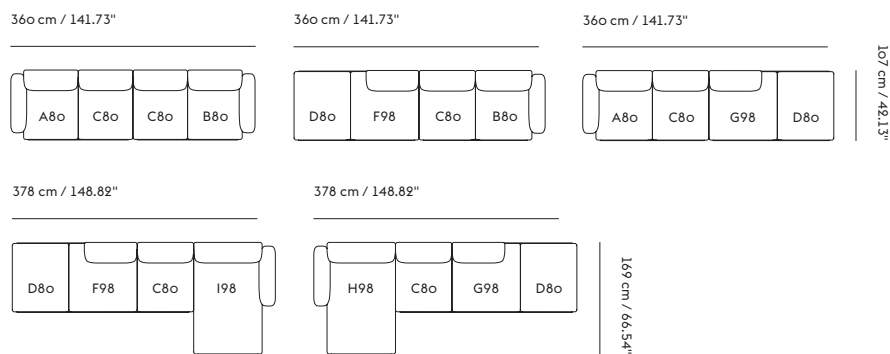

### Corner Configurations



#### General note

The total dimensions of the configurations are indicative and can vary depending on how close the modules are placed as well as how many modules are combined.

# IN SITU MODULAR SOFA / 2-SEATER - CONFIGURATION I



107 cm / 42.13"  
SD 74 cm / 29.2"

198 cm / 77.95"

Shipper Colli	3
Gross Weight (kg)	107.3
Net Weight (kg)	80.74
Warranty Period	10 years

Pattern No.	Color	Contract Price	Lead Time
<b>Ready-To-Ship US Warehouse</b>			
MINS2C1-M16180	Frame and Module - Ocean 80/Black	USD 4,825.00	-
MINS2C1-M244912	Frame and Module - Clay 12/Black	USD 5,511.00	-
MINS2C1-M158554	Frame and Module - Vidar 554/Black	USD 5,511.00	-
<b>Ready-To-Ship EU Warehouse</b>			
MINS2C1-M10767240	Frame and Module - Ecriture 240/Black	USD 5,511.00	-
<b>Extras</b>			
MLEAKIT	Leather care set for Refine Leather	USD 27.00	-

# IN SITU MODULAR SOFA / 2-SEATER - CONFIGURATION 2

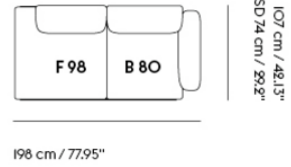

**Shipper Colli** 3  
**Gross Weight (kg)** 96.2  
**Net Weight (kg)** 76.59  
**Warranty Period** 10 years

Pattern No.	Color	Contract Price	Lead Time
<b>Ready-To-Ship US Warehouse</b>			
MINS2C2-M16180	Frame and Module - Ocean 80/Black	USD 4,405.00	-
MINS2C2-M244912	Frame and Module - Clay 12/Black	USD 5,140.00	-
MINS2C2-M158554	Frame and Module - Vidar 554/Black	USD 5,140.00	-
<b>Ready-To-Ship EU Warehouse</b>			
MINS2C2-M10767240	Frame and Module - Ecriture 240/Black	USD 5,140.00	-
<b>Extras</b>			
MLEAKIT	Leather care set for Refine Leather	USD 27.00	-

# IN SITU MODULAR SOFA / 2-SEATER - CONFIGURATION 3

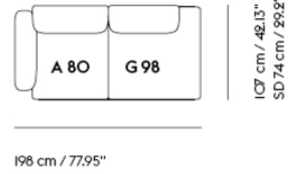

**Shipper Colli** 3  
**Gross Weight (kg)** 102.4  
**Net Weight (kg)** 76.02  
**Warranty Period** 10 years

Pattern No.	Color	Contract Price	Lead Time
<b>Ready-To-Ship US Warehouse</b>			
MINS2C3-M16180	Frame and Module - Ocean 80/Black	USD 4,405.00	-
MINS2C3-M244912	Frame and Module - Clay 12/Black	USD 5,140.00	-
MINS2C3-M158554	Frame and Module - Vidar 554/Black	USD 5,140.00	-
<b>Ready-To-Ship EU Warehouse</b>			
MINS2C3-M10767240	Frame and Module - Ecriture 240/Black	USD 5,140.00	-
<b>Extras</b>			
MLEAKIT	Leather care set for Refine Leather	USD 27.00	-

# IN SITU MODULAR SOFA / 2-SEATER - CONFIGURATION 4

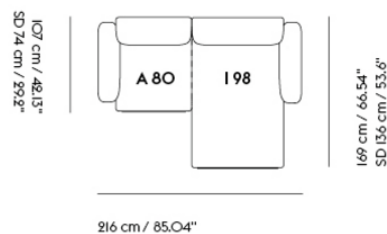
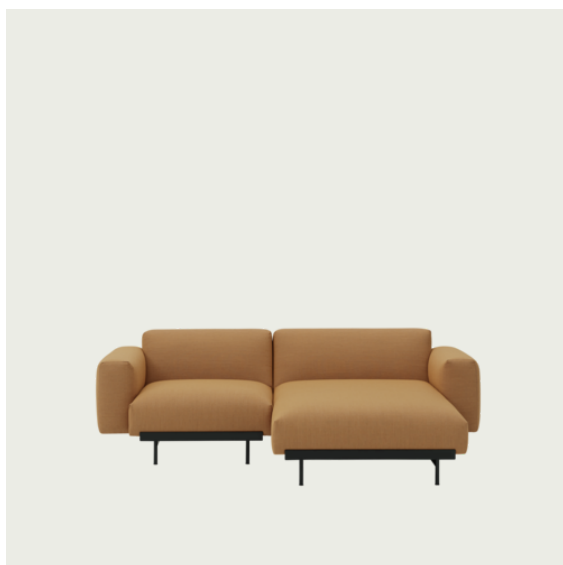

Shipper Colli	5
Gross Weight (kg)	133.8
Net Weight (kg)	103.21
Warranty Period	10 years

Pattern No.	Color	Contract Price	Lead Time
<b>Ready-To-Ship US Warehouse</b>			
MINS2C4-M16180	Frame and Module - Ocean 80/Black	USD 5,511.00	-
MINS2C4-M244912	Frame and Module - Clay 12/Black	USD 6,505.00	-
MINS2C4-M158554	Frame and Module - Vidar 554/Black	USD 6,505.00	-
<b>Ready-To-Ship EU Warehouse</b>			
MINS2C4-M10767240	Frame and Module - Ecriture 240/Black	USD 6,505.00	-
<b>Extras</b>			
MLEAKIT	Leather care set for Refine Leather	USD 27.00	-

# IN SITU MODULAR SOFA / 2-SEATER - CONFIGURATION 5

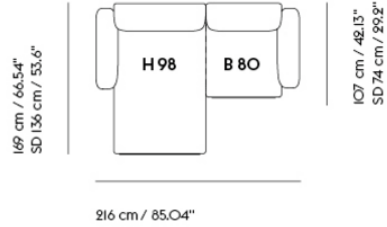

**Shipper Colli** 5  
**Gross Weight (kg)** 133.8  
**Net Weight (kg)** 103.21  
**Warranty Period** 10 years

Pattern No.	Color	Contract Price	Lead Time
<b>Ready-To-Ship US Warehouse</b>			
MINS2C5-M16180	Frame and Module - Ocean 80/Black	USD 5,511.00	-
MINS2C5-M244912	Frame and Module - Clay 12/Black	USD 6,505.00	-
MINS2C5-M158554	Frame and Module - Vidar 554/Black	USD 6,505.00	-
<b>Ready-To-Ship EU Warehouse</b>			
MINS2C5-M10767240	Frame and Module - Ecriture 240/Black	USD 6,505.00	-
<b>Extras</b>			
MLEAKIT	Leather care set for Refine Leather	USD 27.00	-

# IN SITU MODULAR SOFA / 2-SEATER - CONFIGURATION 6

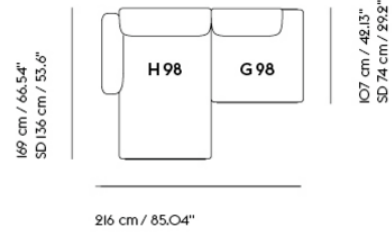

Shipper Colli 5  
 Gross Weight (kg) 128.9  
 Net Weight (kg) 98.49  
 Warranty Period 10 years

Pattern No.	Color	Contract Price	Lead Time
<b>Ready-To-Ship US Warehouse</b>			
MINS2C6-M16180	Frame and Module - Ocean 80/Black	USD 5,140.00	-
MINS2C6-M244912	Frame and Module - Clay 12/Black	USD 6,141.00	-
MINS2C6-M158554	Frame and Module - Vidar 554/Black	USD 6,141.00	-
<b>Ready-To-Ship EU Warehouse</b>			
MINS2C6-M10767240	Frame and Module - Ecriture 240/Black	USD 6,141.00	-
<b>Extras</b>			
MLEAKIT	Leather care set for Refine Leather	USD 27.00	-



# IN SITU MODULAR SOFA / 2-SEATER - CONFIGURATION 7

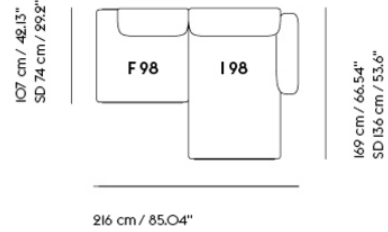

**Shipper Colli** 5  
**Gross Weight (kg)** 122.7  
**Net Weight (kg)** 99.06  
**Warranty Period** 10 years

Pattern No.	Color	Contract Price	Lead Time
<b>Ready-To-Ship US Warehouse</b>			
MINS2C7-M16180	Frame and Module - Ocean 80/Black	USD 5,140.00	-
MINS2C7-M244912	Frame and Module - Clay 12/Black	USD 6,141.00	-
MINS2C7-M158554	Frame and Module - Vidar 554/Black	USD 6,141.00	-
<b>Ready-To-Ship EU Warehouse</b>			
MINS2C7-M10767240	Frame and Module - Ecriture 240/Black	USD 6,141.00	-
<b>Extras</b>			
MLEAKIT	Leather care set for Refine Leather	USD 27.00	-

# IN SITU MODULAR SOFA / 3-SEATER - CONFIGURATION I

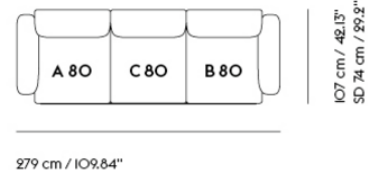

Shipper Colli	4
Gross Weight (kg)	145.5
Net Weight (kg)	110.95
Warranty Period	10 years

Pattern No.	Color	Contract Price	Lead Time
<b>Ready-To-Ship US Warehouse</b>			
MINS3C1-M16180	Frame and Module - Ocean 80/Black	USD 6,561.00	-
MINS3C1-M244912	Frame and Module - Clay 12/Black	USD 7,765.00	-
MINS3C1-M158554	Frame and Module - Vidar 554/Black	USD 7,765.00	-
<b>Ready-To-Ship EU Warehouse</b>			
MINS3C1-M10767240	Frame and Module - Ecriture 240/Black	USD 7,765.00	-
<b>Extras</b>			
MLEAKIT	Leather care set for Refine Leather	USD 27.00	-

# IN SITU MODULAR SOFA / 3-SEATER - CONFIGURATION 2

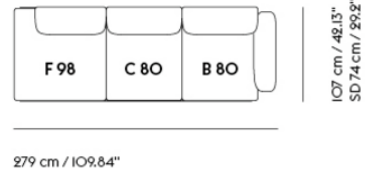

**Shipper Colli** 4  
**Gross Weight (kg)** 134.3  
**Net Weight (kg)** 106.7  
**Warranty Period** 10 years

Pattern No.	Color	Contract Price	Lead Time
<b>Ready-To-Ship US Warehouse</b>			
MINS3C2-M16180	Frame and Module - Ocean 80/Black	USD 6,246.00	-
MINS3C2-M244912	Frame and Module - Clay 12/Black	USD 7,296.00	-
MINS3C2-M158554	Frame and Module - Vidar 554/Black	USD 7,296.00	-
<b>Ready-To-Ship EU Warehouse</b>			
MINS3C2-M10767240	Frame and Module - Ecriture 240/Black	USD 7,296.00	-
<b>Extras</b>			
MLEAKIT	Leather care set for Refine Leather	USD 27.00	-

# IN SITU MODULAR SOFA / 3-SEATER - CONFIGURATION 3

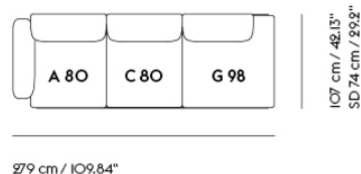

Shipper Colli	4
Gross Weight (kg)	140.5
Net Weight (kg)	106.13
Warranty Period	10 years

Pattern No.	Color	Contract Price	Lead Time
<b>Ready-To-Ship US Warehouse</b>			
MINS3C3-M16180	Frame and Module - Ocean 80/Black	USD 6,246.00	-
MINS3C3-M244912	Frame and Module - Clay 12/Black	USD 7,296.00	-
MINS3C3-M158554	Frame and Module - Vidar 554/Black	USD 7,296.00	-
<b>Ready-To-Ship EU Warehouse</b>			
MINS3C3-M10767240	Frame and Module - Ecriture 240/Black	USD 7,296.00	-
<b>Extras</b>			
MLEAKIT	Leather care set for Refine Leather	USD 27.00	-

# IN SITU MODULAR SOFA / 3-SEATER - CONFIGURATION 4

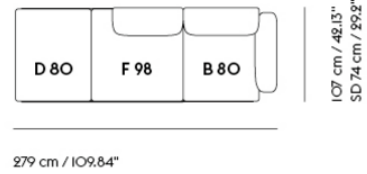

Shipper Colli 4  
 Gross Weight (kg) 122.2  
 Net Weight (kg) 95.07  
 Warranty Period 10 years

Pattern No.	Color	Contract Price	Lead Time
<b>Ready-To-Ship US Warehouse</b>			
MINS3C4-M16180	Frame and Module - Ocean 80/Black	USD 5,616.00	-
MINS3C4-M244912	Frame and Module - Clay 12/Black	USD 6,505.00	-
MINS3C4-M158554	Frame and Module - Vidar 554/Black	USD 6,505.00	-
<b>Ready-To-Ship EU Warehouse</b>			
MINS3C4-M10767240	Frame and Module - Ecriture 240/Black	USD 6,505.00	-
<b>Extras</b>			
MLEAKIT	Leather care set for Refine Leather	USD 27.00	-

# IN SITU MODULAR SOFA / 3-SEATER - CONFIGURATION 5

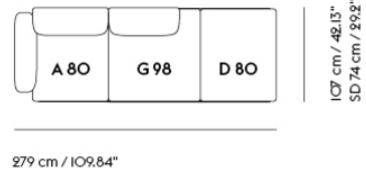

**Shipper Colli** 4  
**Gross Weight (kg)** 128.4  
**Net Weight (kg)** 94.5  
**Warranty Period** 10 years

Pattern No.	Color	Contract Price	Lead Time
<b>Ready-To-Ship US Warehouse</b>			
MINS3C5-M16180	Frame and Module - Ocean 80/Black	USD 5,616.00	-
MINS3C5-M244912	Frame and Module - Clay 12/Black	USD 6,505.00	-
MINS3C5-M158554	Frame and Module - Vidar 554/Black	USD 6,505.00	-
<b>Ready-To-Ship EU Warehouse</b>			
MINS3C5-M10767240	Frame and Module - Ecriture 240/Black	USD 6,505.00	-
<b>Extras</b>			
MLEAKIT	Leather care set for Refine Leather	USD 27.00	-

# IN SITU MODULAR SOFA / 3-SEATER - CONFIGURATION 6

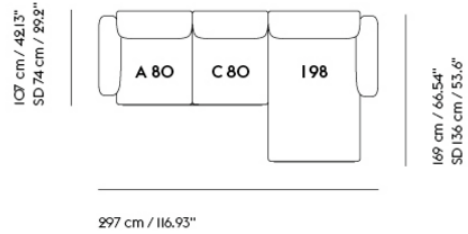

Shipper Colli	6
Gross Weight (kg)	171.9
Net Weight (kg)	133.22
Warranty Period	10 years

Pattern No.	Color	Contract Price	Lead Time
<b>Ready-To-Ship US Warehouse</b>			
MINS3C6-M16180	Frame and Module - Ocean 80/Black	USD 7,296.00	-
MINS3C6-M244912	Frame and Module - Clay 12/Black	USD 8,661.00	-
MINS3C6-M158554	Frame and Module - Vidar 554/Black	USD 8,661.00	-
<b>Ready-To-Ship EU Warehouse</b>			
MINS3C6-M10767240	Frame and Module - Ecriture 240/Black	USD 8,661.00	-
<b>Extras</b>			
MLEAKIT	Leather care set for Refine Leather	USD 27.00	-

# IN SITU MODULAR SOFA / 3-SEATER - CONFIGURATION 7

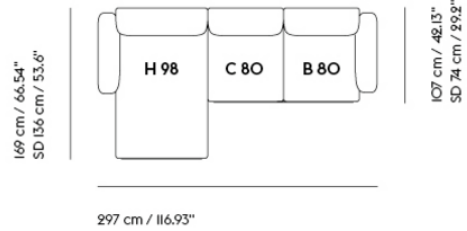

Shipper Colli	6
Gross Weight (kg)	171.9
Net Weight (kg)	133.22
Warranty Period	10 years

Pattern No.	Color	Contract Price	Lead Time
<b>Ready-To-Ship US Warehouse</b>			
MINS3C7-M16180	Frame and Module - Ocean 80/Black	USD 7,296.00	-
MINS3C7-M244912	Frame and Module - Clay 12/Black	USD 8,661.00	-
MINS3C7-M158554	Frame and Module - Vidar 554/Black	USD 8,661.00	-
<b>Ready-To-Ship EU Warehouse</b>			
MINS3C7-M10767240	Frame and Module - Ecriture 240/Black	USD 8,661.00	-
<b>Extras</b>			
MLEAKIT	Leather care set for Refine Leather	USD 27.00	-



# IN SITU MODULAR SOFA / 3-SEATER - CONFIGURATION 8

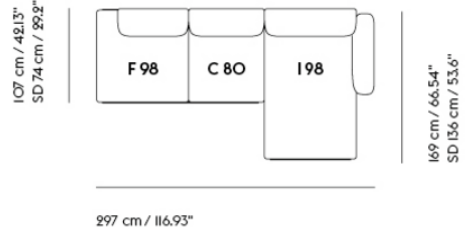

**Shipper Colli** 6  
**Gross Weight (kg)** 160.8  
**Net Weight (kg)** 129.07  
**Warranty Period** 10 years

Pattern No.	Color	Contract Price	Lead Time
<b>Ready-To-Ship US Warehouse</b>			
MINS3C8-M16180	Frame and Module - Ocean 80/Black	USD 6,876.00	-
MINS3C8-M244912	Frame and Module - Clay 12/Black	USD 8,290.00	-
MINS3C8-M158554	Frame and Module - Vidar 554/Black	USD 8,290.00	-
<b>Ready-To-Ship EU Warehouse</b>			
MINS3C8-M10767240	Frame and Module - Ecriture 240/Black	USD 8,290.00	-
<b>Extras</b>			
MLEAKIT	Leather care set for Refine Leather	USD 27.00	-

# IN SITU MODULAR SOFA / 3-SEATER - CONFIGURATION 9

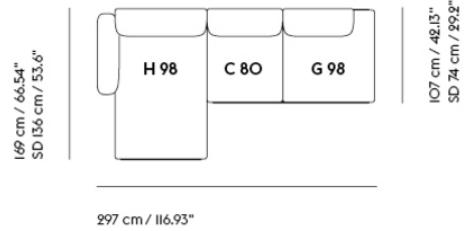

**Shipper Colli** 6  
**Gross Weight (kg)** 167  
**Net Weight (kg)** 128.5  
**Warranty Period** 10 years

Pattern No.	Color	Contract Price	Lead Time
<b>Ready-To-Ship US Warehouse</b>			
MINS3C9-M16180	Frame and Module - Ocean 80/Black	USD 6,876.00	-
MINS3C9-M244912	Frame and Module - Clay 12/Black	USD 8,290.00	-
MINS3C9-M158554	Frame and Module - Vidar 554/Black	USD 8,290.00	-
<b>Ready-To-Ship EU Warehouse</b>			
MINS3C9-M10767240	Frame and Module - Ecriture 240/Black	USD 8,290.00	-
<b>Extras</b>			
MLEAKIT	Leather care set for Refine Leather	USD 27.00	-

# IN SITU MODULAR SOFA / 4-SEATER - CONFIGURATION I

200

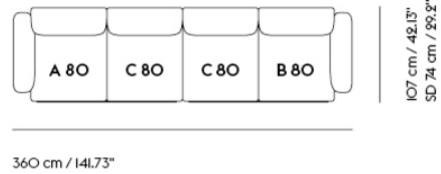

Shipper Colli	7
Gross Weight (kg)	191.2
Net Weight (kg)	147.5
Warranty Period	10 years

Pattern No.	Color	Contract Price	Lead Time
<b>Ready-To-Ship US Warehouse</b>			
MINS4C1-M16180	Frame and Module - Ocean 80/Black	USD 8,346.00	-
MINS4C1-M244912	Frame and Module - Clay 12/Black	USD 9,921.00	-
MINS4C1-M158554	Frame and Module - Vidar 554/Black	USD 9,921.00	-
<b>Ready-To-Ship EU Warehouse</b>			
MINS4C1-M10767240	Frame and Module - Ecriture 240/Black	USD 9,921.00	-
<b>Extras</b>			
MLEAKIT	Leather care set for Refine Leather	USD 27.00	-

# IN SITU MODULAR SOFA / 4-SEATER - CONFIGURATION 2

201

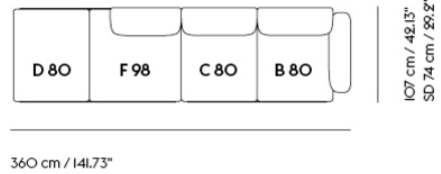

Shipper Colli	7
Gross Weight (kg)	168
Net Weight (kg)	131.72
Warranty Period	10 years

Pattern No.	Color	Contract Price	Lead Time
<b>Ready-To-Ship US Warehouse</b>			
MINS4C2-M16180	Frame and Module - Ocean 80/Black	USD 7,450.00	-
MINS4C2-M244912	Frame and Module - Clay 12/Black	USD 8,766.00	-
MINS4C2-M158554	Frame and Module - Vidar 554/Black	USD 8,766.00	-
<b>Ready-To-Ship EU Warehouse</b>			
MINS4C2-M10767240	Frame and Module - Ecriture 240/Black	USD 8,766.00	-
<b>Extras</b>			
MLEAKIT	Leather care set for Refine Leather	USD 27.00	-

# IN SITU MODULAR SOFA / 4-SEATER - CONFIGURATION 3

202

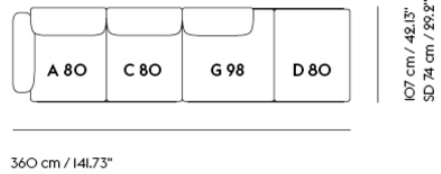

Shipper Colli	7
Gross Weight (kg)	174.2
Net Weight (kg)	131.15
Warranty Period	10 years

Pattern No.	Color	Contract Price	Lead Time
<b>Ready-To-Ship US Warehouse</b>			
MINS4C3-M16180	Frame and Module - Ocean 80/Black	USD 7,450.00	-
MINS4C3-M244912	Frame and Module - Clay 12/Black	USD 8,766.00	-
MINS4C3-M158554	Frame and Module - Vidar 554/Black	USD 8,766.00	-
<b>Ready-To-Ship EU Warehouse</b>			
MINS4C3-M10767240	Frame and Module - Ecriture 240/Black	USD 8,766.00	-
<b>Extras</b>			
MLEAKIT	Leather care set for Refine Leather	USD 27.00	-

# IN SITU MODULAR SOFA / 4-SEATER - CONFIGURATION 4

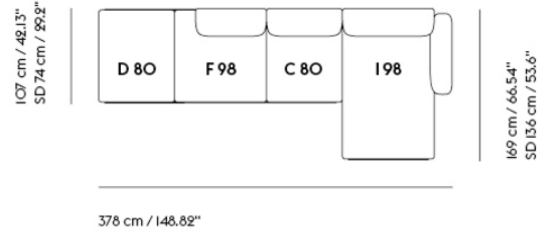

Shipper Colli 7  
 Gross Weight (kg) 186.8  
 Net Weight (kg) 147.55  
 Warranty Period 10 years

Pattern No.	Color	Contract Price	Lead Time
<b>Ready-To-Ship US Warehouse</b>			
MINS4C4-M16180	Frame and Module - Ocean 80/Black	USD 8,031.00	-
MINS4C4-M244912	Frame and Module - Clay 12/Black	USD 9,606.00	-
MINS4C4-M158554	Frame and Module - Vidar 554/Black	USD 9,606.00	-
<b>Ready-To-Ship EU Warehouse</b>			
MINS4C4-M10767240	Frame and Module - Ecriture 240/Black	USD 9,606.00	-
<b>Extras</b>			
MLEAKIT	Leather care set for Refine Leather	USD 27.00	-

# IN SITU MODULAR SOFA / 4-SEATER - CONFIGURATION 5

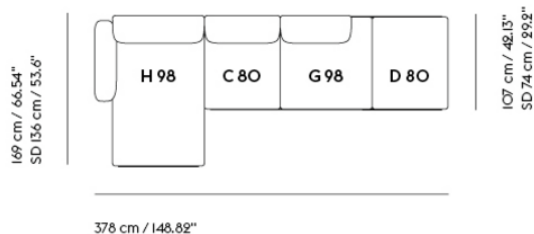

Shipper Colli	7
Gross Weight (kg)	193
Net Weight (kg)	146.98
Warranty Period	10 years

Pattern No.	Color	Contract Price	Lead Time
<b>Ready-To-Ship US Warehouse</b>			
MINS4C5-M16180	Frame and Module - Ocean 80/Black	USD 8,031.00	-
MINS4C5-M244912	Frame and Module - Clay 12/Black	USD 9,606.00	-
MINS4C5-M158554	Frame and Module - Vidar 554/Black	USD 9,606.00	-
<b>Ready-To-Ship EU Warehouse</b>			
MINS4C5-M10767240	Frame and Module - Ecriture 240/Black	USD 9,606.00	-
<b>Extras</b>			
MLEAKIT	Leather care set for Refine Leather	USD 27.00	-

# IN SITU MODULAR SOFA / CORNER - CONFIGURATION I

205

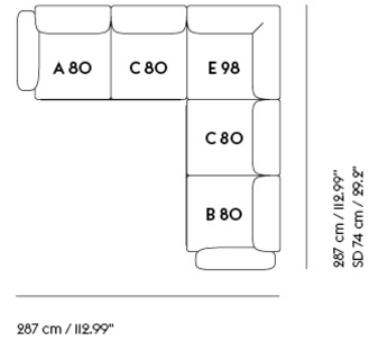

Shipper Colli	10
Gross Weight (kg)	249.4
Net Weight (kg)	192.2
Warranty Period	10 years

Pattern No.	Color	Contract Price	Lead Time
<b>Ready-To-Ship US Warehouse</b>			
MINSPSCC1-M16180	Frame and Module - Ocean 80/Black	USD 11,545.00	-
MINSPSCC1-M244912	Frame and Module - Clay 12/Black	USD 13,120.00	-
MINSPSCC1-M158554	Frame and Module - Vidar 554/Black	USD 13,120.00	-
<b>Ready-To-Ship EU Warehouse</b>			
MINSPSCC1-M10767240	Frame and Module - Ecriture 240/Black	USD 13,120.00	-
<b>Extras</b>			
MLEAKIT	Leather care set for Refine Leather	USD 27.00	-



# IN SITU MODULAR SOFA / CORNER - CONFIGURATION 2

206

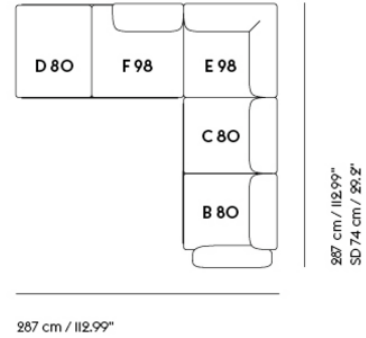

Shipper Colli	10
Gross Weight (kg)	226.2
Net Weight (kg)	176.42
Warranty Period	10 years

Pattern No.	Color	Contract Price	Lead Time
<b>Ready-To-Ship US Warehouse</b>			
MINSPSCC2-M16180	Frame and Module - Ocean 80/Black	USD 10,131.00	-
MINSPSCC2-M244912	Frame and Module - Clay 12/Black	USD 12,070.00	-
MINSPSCC2-M158554	Frame and Module - Vidar 554/Black	USD 12,070.00	-
<b>Ready-To-Ship EU Warehouse</b>			
MINSPSCC2-M10767240	Frame and Module - Ecriture 240/Black	USD 12,070.00	-
<b>Extras</b>			
MLEAKIT	Leather care set for Refine Leather	USD 27.00	-

# IN SITU MODULAR SOFA / CORNER - CONFIGURATION 3

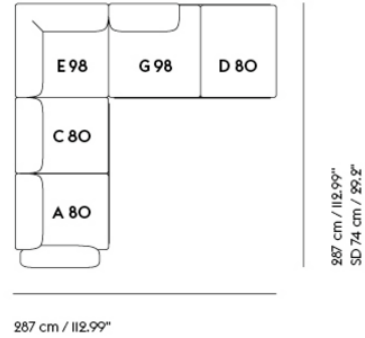

Shipper Colli	10
Gross Weight (kg)	232.4
Net Weight (kg)	175.85
Warranty Period	10 years

Pattern No.	Color	Contract Price	Lead Time
<b>Ready-To-Ship US Warehouse</b>			
MINSPSCC3-M16180	Frame and Module - Ocean 80/Black	USD 10,131.00	-
MINSPSCC3-M244912	Frame and Module - Clay 12/Black	USD 12,070.00	-
MINSPSCC3-M158554	Frame and Module - Vidar 554/Black	USD 12,070.00	-
<b>Ready-To-Ship EU Warehouse</b>			
MINSPSCC3-M10767240	Frame and Module - Ecriture 240/Black	USD 12,070.00	-
<b>Extras</b>			
MLEAKIT	Leather care set for Refine Leather	USD 27.00	-

# IN SITU MODULAR SOFA / CORNER - CONFIGURATION 4

208

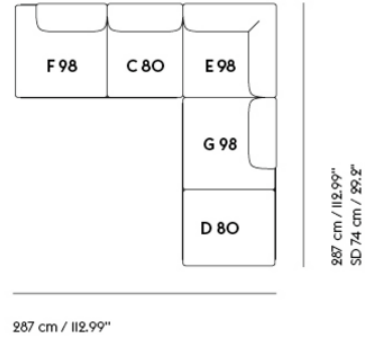

Shipper Colli	10
Gross Weight (kg)	221.3
Net Weight (kg)	171.7
Warranty Period	10 years

Pattern No.	Color	Contract Price	Lead Time
<b>Ready-To-Ship US Warehouse</b>			
MINSPPCC4-M16180	Frame and Module - Ocean 80/Black	USD 9,711.00	-
MINSPPCC4-M244912	Frame and Module - Clay 12/Black	USD 11,545.00	-
MINSPPCC4-M158554	Frame and Module - Vidar 554/Black	USD 11,545.00	-
<b>Ready-To-Ship EU Warehouse</b>			
MINSPPCC4-M10767240	Frame and Module - Ecriture 240/Black	USD 11,545.00	-
<b>Extras</b>			
MLEAKIT	Leather care set for Refine Leather	USD 27.00	-

# IN SITU MODULAR SOFA / CORNER - CONFIGURATION 5

209

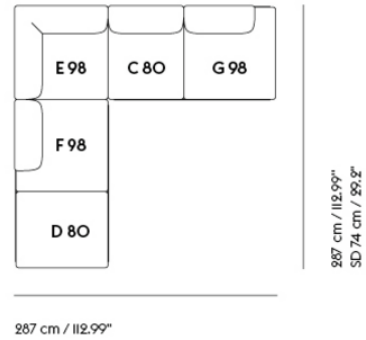

Shipper Colli	10
Gross Weight (kg)	221.3
Net Weight (kg)	171.7
Warranty Period	10 years

Pattern No.	Color	Contract Price	Lead Time
<b>Ready-To-Ship US Warehouse</b>			
MINSPSCC5-M16180	Frame and Module - Ocean 80/Black	USD 9,711.00	-
MINSPSCC5-M244912	Frame and Module - Clay 12/Black	USD 11,545.00	-
MINSPSCC5-M158554	Frame and Module - Vidar 554/Black	USD 11,545.00	-
<b>Ready-To-Ship EU Warehouse</b>			
MINSPSCC5-M10767240	Frame and Module - Ecriture 240/Black	USD 11,545.00	-
<b>Extras</b>			
MLEAKIT	Leather care set for Refine Leather	USD 27.00	-

# IN SITU MODULAR SOFA / CORNER - CONFIGURATION 6

210

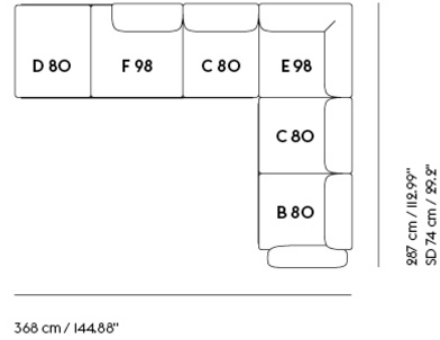

Shipper Colli	11
Gross Weight (kg)	264.3
Net Weight (kg)	206.53
Warranty Period	10 years

Pattern No.	Color	Contract Price	Lead Time
<b>Ready-To-Ship US Warehouse</b>			
MINSPSCC6-M16180	Frame and Module - Ocean 80/Black	USD 12,070.00	-
MINSPSCC6-M244912	Frame and Module - Clay 12/Black	USD 14,170.00	-
MINSPSCC6-M158554	Frame and Module - Vidar 554/Black	USD 14,170.00	-
<b>Ready-To-Ship EU Warehouse</b>			
MINSPSCC6-M10767240	Frame and Module - Ecriture 240/Black	USD 14,170.00	-
<b>Extras</b>			
MLEAKIT	Leather care set for Refine Leather	USD 27.00	-

# IN SITU MODULAR SOFA / CORNER - CONFIGURATION 7

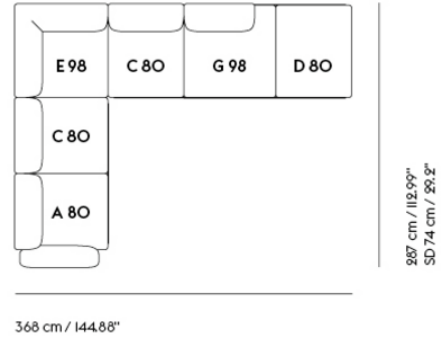

**Shipper Colli** II  
**Gross Weight (kg)** 270.5  
**Net Weight (kg)** 205.96  
**Warranty Period** 10 years

Pattern No.	Color	Contract Price	Lead Time
<b>Ready-To-Ship US Warehouse</b>			
MINSPSCC7-M16180	Frame and Module - Ocean 80/Black	USD 12,070.00	-
MINSPSCC7-M244912	Frame and Module - Clay 12/Black	USD 14,170.00	-
MINSPSCC7-M158554	Frame and Module - Vidar 554/Black	USD 14,170.00	-
<b>Ready-To-Ship EU Warehouse</b>			
MINSPSCC7-M10767240	Frame and Module - Ecriture 240/Black	USD 14,170.00	-
<b>Extras</b>			
MLEAKIT	Leather care set for Refine Leather	USD 27.00	-

# IN SITU MODULAR SOFA / CORNER - CONFIGURATION 8

212

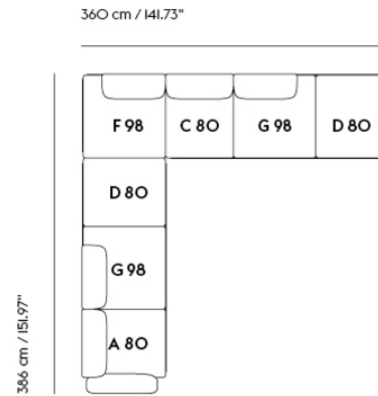

Shipper Colli	12
Gross Weight (kg)	288.5
Net Weight (kg)	218.46
Warranty Period	10 years

Pattern No.	Color	Contract Price	Lead Time
<b>Ready-To-Ship US Warehouse</b>			
MINSPPCC8-M16180	Frame and Module - Ocean 80/Black	USD 12,595.00	-
MINSPPCC8-M244912	Frame and Module - Clay 12/Black	USD 15,745.00	-
MINSPPCC8-M158554	Frame and Module - Vidar 554/Black	USD 15,745.00	-
<b>Ready-To-Ship EU Warehouse</b>			
MINSPPCC8-M10767240	Frame and Module - Ecriture 240/Black	USD 15,745.00	-
<b>Extras</b>			
MLEAKIT	Leather care set for Refine Leather	USD 27.00	-

# IN SITU MODULAR SOFA / CORNER - CONFIGURATION 9

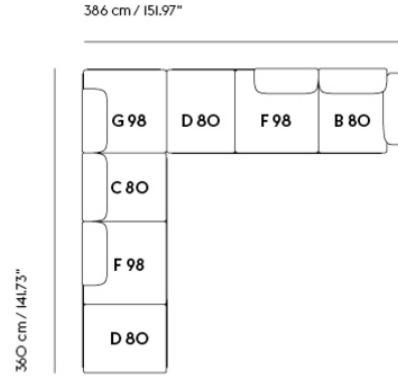

**Shipper Colli** 12  
**Gross Weight (kg)** 282.3  
**Net Weight (kg)** 219.03  
**Warranty Period** 10 years

Pattern No.	Color	Contract Price	Lead Time
<b>Ready-To-Ship US Warehouse</b>			
MINSPSCC9-M16180	Frame and Module - Ocean 80/Black	USD 12,595.00	-
MINSPSCC9-M244912	Frame and Module - Clay 12/Black	USD 15,745.00	-
MINSPSCC9-M158554	Frame and Module - Vidar 554/Black	USD 15,745.00	-
<b>Ready-To-Ship EU Warehouse</b>			
MINSPSCC9-M10767240	Frame and Module - Ecriture 240/Black	USD 15,745.00	-
<b>Extras</b>			
MLEAKIT	Leather care set for Refine Leather	USD 27.00	-



# IN SITU MODULAR SOFA / LEFT ARMREST MODULE (A80)

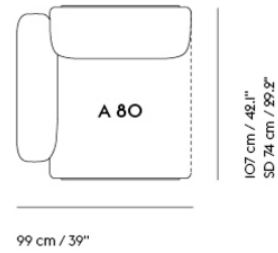

<b>Shipper Colli</b>	1
<b>Gross Weight (kg)</b>	42.7
<b>Net Weight (kg)</b>	31.25
<b>Please note</b>	This product features an armrest on the left-hand side when facing the product from the front.
<b>Please note</b>	This variant is a Seating Module only and does not include a Frame Section.
<b>Warranty Period</b>	10 years

Pattern No.	Color	Contract Price	Lead Time
<b>Ready-To-Ship US Warehouse</b>			
MINSAML-M16180	Ocean 80	USD 2,256.00	-
MINSAML-M244912	Clay 12	USD 2,571.00	-
MINSAML-M158554	Vidar 554	USD 2,571.00	-
<b>Ready-To-Ship EU Warehouse</b>			
MINSAML-M10767240	Ecriture 240	USD 2,571.00	-
<b>Extras</b>			
MLEAKIT	Leather care set for Refine Leather	USD 27.00	-

# IN SITU MODULAR SOFA / RIGHT ARMREST MODULE (B80)

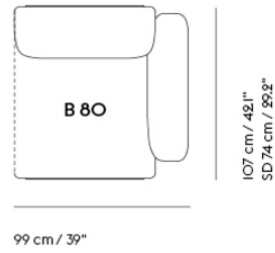

- Shipper Colli** | 1
- Gross Weight (kg)** | 42.7
- Net Weight (kg)** | 31.25
- Please note** | This product features an armrest on the right-hand side when facing the product from the front.
- Please note** | This variant is a Seating Module only and does not include a Frame Section.
- Warranty Period** | 10 years

Pattern No.	Color	Contract Price	Lead Time
<b>Ready-To-Ship US Warehouse</b>			
MINSAMR-M16180	Ocean 80	USD 2,256.00	-
MINSAMR-M244912	Clay 12	USD 2,571.00	-
MINSAMR-M158554	Vidar 554	USD 2,571.00	-
<b>Ready-To-Ship EU Warehouse</b>			
MINSAMR-M10767240	Ecriture 240	USD 2,571.00	-
<b>Extras</b>			
MLEAKIT	Leather care set for Refine Leather	USD 27.00	-

# IN SITU MODULAR SOFA / CENTRE MODULE (C80)

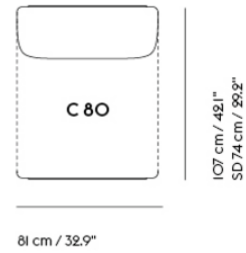
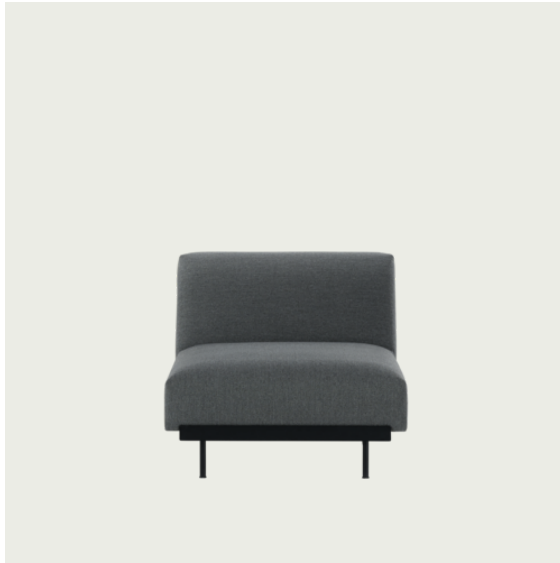

Shipper Colli	1
Gross Weight (kg)	30.2
Net Weight (kg)	23.53
Please note	This variant is a Seating Module only and does not include a Frame Section.
Warranty Period	10 years

Pattern No.	Color	Contract Price	Lead Time
<b>Ready-To-Ship US Warehouse</b>			
MINSCTM-M16180	Ocean 80	USD 1,570.00	-
MINSCTM-M244912	Clay 12	USD 2,046.00	-
MINSCTM-M158554	Vidar 554 ***	USD 2,046.00	-
<b>Ready-To-Ship EU Warehouse</b>			
MINSCTM-M10767240	Ecriture 240	USD 2,046.00	-
<b>Extras</b>			
MLEAKIT	Leather care set for Refine Leather	USD 27.00	-

# IN SITU MODULAR SOFA / OTTOMAN MODULE (D80)

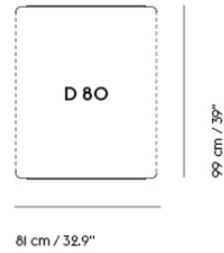
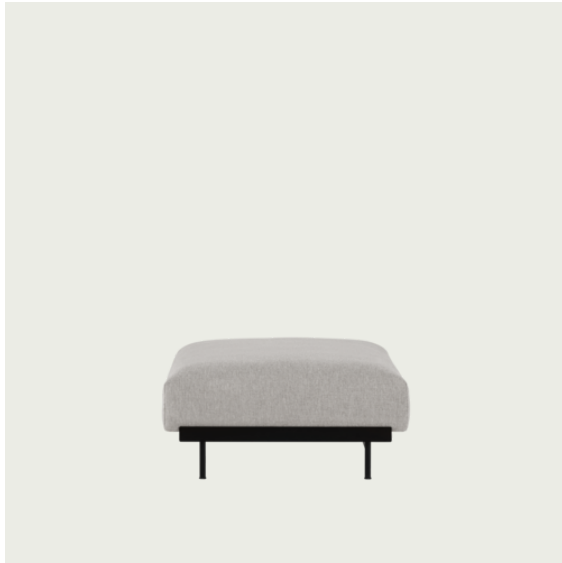

- Shipper Colli 1
- Gross Weight (kg) 18.1
- Net Weight (kg) 11.9
- Please note This variant is a Seating Module only and does not include a Frame Section.
- Warranty Period 10 years

Pattern No.	Color	Contract Price	Lead Time
<b>Ready-To-Ship US Warehouse</b>			
MINSOTM-M16180	Ocean 80	USD 881.00	-
MINSOTM-M244912	Clay 12	USD 1,101.00	-
MINSOTM-M158554	Vidar 554	USD 1,101.00	-
<b>Ready-To-Ship EU Warehouse</b>			
MINSOTM-M10767240	Ecriture 240	USD 1,101.00	-
<b>Extras</b>			
MLEAKIT	Leather care set for Refine Leather	USD 27.00	-

# IN SITU MODULAR SOFA / CORNER MODULE (E98)

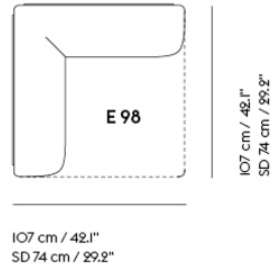

**Shipper Colli** | 1  
**Gross Weight (kg)** 45.8  
**Net Weight (kg)** 34.68  
**Please note** This variant is a Seating Module only and does not include a Frame Section.  
**Warranty Period** 10 years

Pattern No.	Color	Contract Price	Lead Time
<b>Ready-To-Ship US Warehouse</b>			
MINSCOM-M16180	Ocean 80	USD 2,515.00	-
MINSCOM-M244912	Clay 12	USD 2,886.00	-
MINSCOM-M158554	Vidar 554	USD 2,886.00	-
<b>Ready-To-Ship EU Warehouse</b>			
MINSCOM-M10767240	Ecriture 240	USD 2,886.00	-
<b>Extras</b>			
MLEAKIT	Leather care set for Refine Leather	USD 27.00	-

# IN SITU MODULAR SOFA / LEFT OPEN-ENDED MODULE (F98)

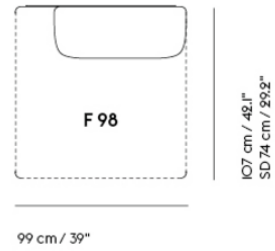

<b>Shipper Colli</b>	1
<b>Gross Weight (kg)</b>	30.2
<b>Net Weight (kg)</b>	25.7
<b>Please note</b>	This product features an open end on the left-hand side when facing the product from the front.
<b>Please note</b>	This variant is a Seating Module only and does not include a Frame Section.
<b>Warranty Period</b>	10 years

Pattern No.	Color	Contract Price	Lead Time
<b>Ready-To-Ship US Warehouse</b>			
MINSOEML-M16180	Ocean 80	USD 1,731.00	-
MINSOEML-M244912	Clay 12	USD 2,256.00	-
MINSOEML-M158554	Vidar 554	USD 2,256.00	-
<b>Ready-To-Ship EU Warehouse</b>			
MINSOEML-M10767240	Ecriture 240	USD 2,256.00	-
<b>Extras</b>			
MLEAKIT	Leather care set for Refine Leather	USD 27.00	-

# IN SITU MODULAR SOFA / RIGHT OPEN-ENDED MODULE (G98)

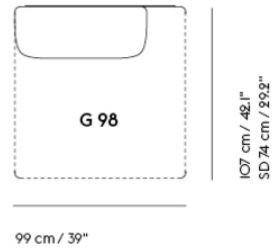

<b>Shipper Colli</b>	
<b>Gross Weight (kg)</b>	36.4
<b>Net Weight (kg)</b>	25.13
<b>Please note</b>	This product features an open end on the right-hand side when facing the product from the front.
<b>Please note</b>	This variant is a Seating Module only and does not include a Frame Section.
<b>Warranty Period</b>	10 years

Pattern No.	Color	Contract Price	Lead Time
<b>Ready-To-Ship US Warehouse</b>			
MINSOEMR-M16180	Ocean 80	USD 1,731.00	-
MINSOEMR-M244912	Clay 12	USD 2,256.00	-
MINSOEMR-M158554	Vidar 554	USD 2,256.00	-
<b>Ready-To-Ship EU Warehouse</b>			
MINSOEMR-M10767240	Ecriture 240	USD 2,256.00	-
<b>Extras</b>			
MLEAKIT	Leather care set for Refine Leather	USD 27.00	-

# IN SITU MODULAR SOFA / LEFT ARMREST LOUNGE MODULE (H98)

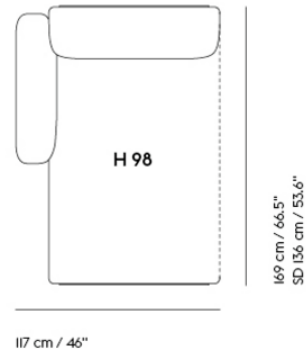

- Shipper Colli** | 1
- Gross Weight (kg)** 55.8
- Net Weight (kg)** 42.7
- Please note** This product features an armrest on the left-hand side when facing the product from the front.
- Please note** This variant is a Seating Module only and does not include a Frame Section.
- Warranty Period** 10 years

Pattern No.	Color	Contract Price	Lead Time
<b>Ready-To-Ship US Warehouse</b>			
MINSALML-M16180	Ocean 80	USD 2,830.00	-
MINSALML-M244912	Clay 12	USD 3,516.00	-
MINSALML-M158554	Vidar 554	USD 3,516.00	-
<b>Ready-To-Ship EU Warehouse</b>			
MINSALML-M10767240	Ecriture 240	USD 3,516.00	-
<b>Extras</b>			
MLEAKIT	Leather care set for Refine Leather	USD 27.00	-



# IN SITU MODULAR SOFA / RIGHT ARMREST LOUNGE MODULE (I98)

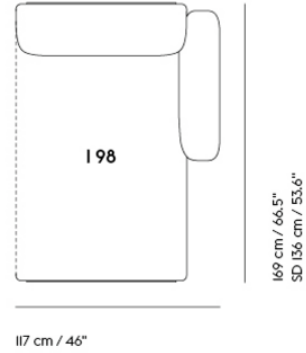

- Shipper Colli** | 1
- Gross Weight (kg)** 55.8
- Net Weight (kg)** 42.7
- Please note** This product features an armrest on the right-hand side when facing the product from the front.
- Please note** This variant is a Seating Module only and does not include a Frame Section.
- Warranty Period** 10 years

Pattern No.	Color	Contract Price	Lead Time
<b>Ready-To-Ship US Warehouse</b>			
MINSALMR-M16180	Ocean 80	USD 2,830.00	-
MINSALMR-M244912	Clay 12	USD 3,516.00	-
MINSALMR-M158554	Vidar 554	USD 3,516.00	-
<b>Ready-To-Ship EU Warehouse</b>			
MINSALMR-M10767240	Ecriture 240	USD 3,516.00	-
<b>Extras</b>			
MLEAKIT	Leather care set for Refine Leather	USD 27.00	-

# IN SITU MODULAR SOFA / CUSHION — 70 X 30 CM / 27.6 X 11.8"

223

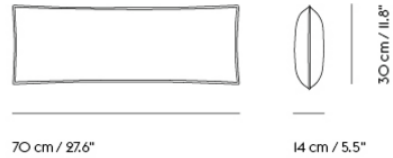

Shipper Colli	1
Gross Weight (kg)	0.8
Net Weight (kg)	0.8
Warranty Period	10 years

Pattern No.	Color	Contract Price	Lead Time
<b>Ready-To-Ship US Warehouse</b>			
MINSCUS2610-M16180	Ocean 80	USD 167.00	-
MINSCUS2610-M244912	Clay 12	USD 257.00	-
MINSCUS2610-M158554	Vidar 554	USD 257.00	-
<b>Extras</b>			
MLEAKIT	Leather care set for Refine Leather	USD 27.00	-

**IN SITU MODULAR SOFA / CUSHION —  
70 X 50 CM / 27.6 X 19.7"**

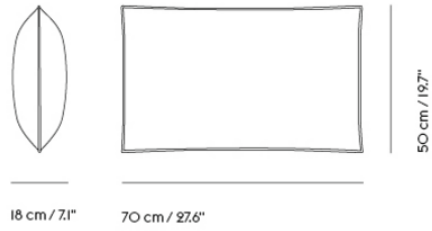

Shipper Colli 1  
 Gross Weight (kg) 1.75  
 Net Weight (kg) 1.75  
 Warranty Period 10 years

Pattern No.	Color	Contract Price	Lead Time
<b>Ready-To-Ship US Warehouse</b>			
MINSCUS2618-M16180	Ocean 80	USD 226.00	-
MINSCUS2618-M244912	Clay 12	USD 310.00	-
MINSCUS2618-M158554	Vidar 554	USD 310.00	-
<b>Extras</b>			
MLEAKIT	Leather care set for Refine Leather	USD 27.00	-

# IN SITU MODULAR SOFA / FRAME SECTION (1 X 80)

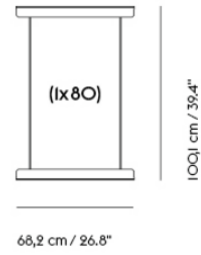

**Shipper Colli** 1  
**Gross Weight (kg)** 14  
**Net Weight (kg)** 11.76  
**Warranty Period** 10 years

Pattern No.	Color	Contract Price	Lead Time
<b>Ready-To-Ship US Warehouse</b>			
MINSFRMS80	Black - 1 x 80	USD 289.00	-

# IN SITU MODULAR SOFA / FRAME SECTION (1 X 98)

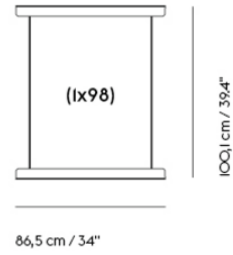

**Shipper Colli** 1  
**Gross Weight (kg)** 15.4  
**Net Weight (kg)** 13.16  
**Warranty Period** 10 years

Pattern No.	Color	Contract Price	Lead Time
<b>Ready-To-Ship US Warehouse</b>			
MINSFRMS98	Black - 1 x 98	USD 289.00	-

# IN SITU MODULAR SOFA / FRAME SECTION (2 X 80)

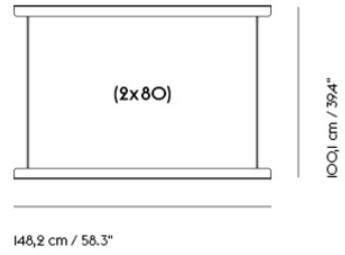

**Shipper Colli** 1  
**Gross Weight (kg)** 21.9  
**Net Weight (kg)** 18.24  
**Warranty Period** 10 years

Pattern No.	Color	Contract Price	Lead Time
<b>Ready-To-Ship US Warehouse</b>			
MINSFRMS8080	Black - 2 x 80	USD 576.00	-

# IN SITU MODULAR SOFA / FRAME SECTION (2 X 98)

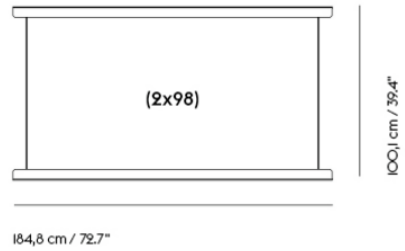

**Shipper Colli** 1  
**Gross Weight (kg)** 24.8  
**Net Weight (kg)** 21.14  
**Warranty Period** 10 years

Pattern No.	Color	Contract Price	Lead Time
<b>Ready-To-Ship US Warehouse</b>			
MINSFRMS9898	Black - 2 x 98	USD 576.00	-

# IN SITU MODULAR SOFA / FRAME SECTION (3 X 80)

229

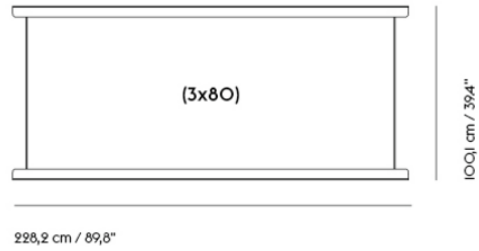

**Shipper Colli** 1  
**Gross Weight (kg)** 29,9  
**Net Weight (kg)** 24,92  
**Warranty Period** 10 years

Pattern No.	Color	Contract Price	Lead Time
<b>Ready-To-Ship US Warehouse</b>			
MINSFRMS808080	Black - 3 x 80	USD 866.00	-



# IN SITU MODULAR SOFA / FRAME SECTION (1 X 80 + 1 X 98)

230

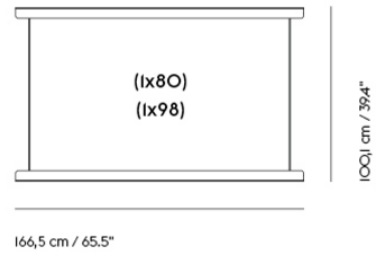

**Shipper Colli** 1  
**Gross Weight (kg)** 23.3  
**Net Weight (kg)** 19.64  
**Warranty Period** 10 years

Pattern No.	Color	Contract Price	Lead Time
<b>Ready-To-Ship US Warehouse</b>			
MINSFRMS8098	Black - 1 x 80 + 1 x 98	USD 576.00	-

# IN SITU MODULAR SOFA / FRAME SECTION (1 X 80 + 2 X 98)

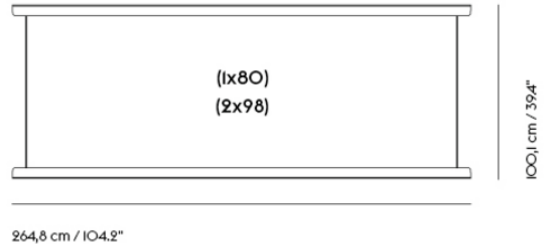

**Shipper Colli** 1  
**Gross Weight (kg)** 33  
**Net Weight (kg)** 28.02  
**Warranty Period** 10 years

Pattern No.	Color	Contract Price	Lead Time
<b>Ready-To-Ship US Warehouse</b>			
MINSFRMS809898	Black - 1 x 80 + 2 x 98	USD 866.00	-

**IN SITU MODULAR SOFA / FRAME  
SECTION (2 X 80 + 1 X 98)**

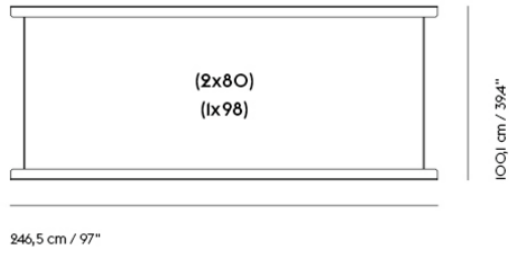

Shipper Colli 1  
 Gross Weight (kg) 31.2  
 Net Weight (kg) 26.22  
 Warranty Period 10 years

Pattern No.	Color	Contract Price	Lead Time
<b>Ready-To-Ship US Warehouse</b>			
MINSFRMS808098	Black - 2 x 80 + 1 x 98	USD 866.00	-

**IN SITU MODULAR SOFA / CHAISE  
LOUNGE FRAME SECTION (1 X 98)**

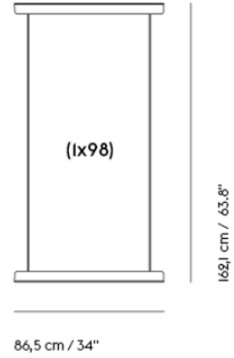

Shipper Colli 1  
 Gross Weight (kg) 19.7  
 Net Weight (kg) 16.04  
 Warranty Period 10 years

Pattern No.	Color	Contract Price	Lead Time
<b>Ready-To-Ship US Warehouse</b>			
MINSFRML98	Black - 1 x 98 Chaise Lounge	USD 289.00	-

**IN SITU MODULAR SOFA / CORNER  
FRAME SECTION (1 X 98)**

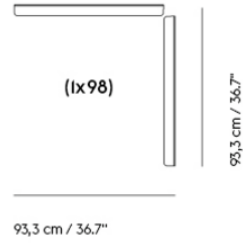

Shipper Colli 1  
 Gross Weight (kg) 10.8  
 Net Weight (kg) 8.56  
 Warranty Period 10 years

Pattern No.	Color	Contract Price	Lead Time
<b>Ready-To-Ship US Warehouse</b>			
MINSFRMC98	Black - 1 x 98 Corner	USD 289.00	-

# IN SITU MODULAR SOFA LINKING BRACKET

235

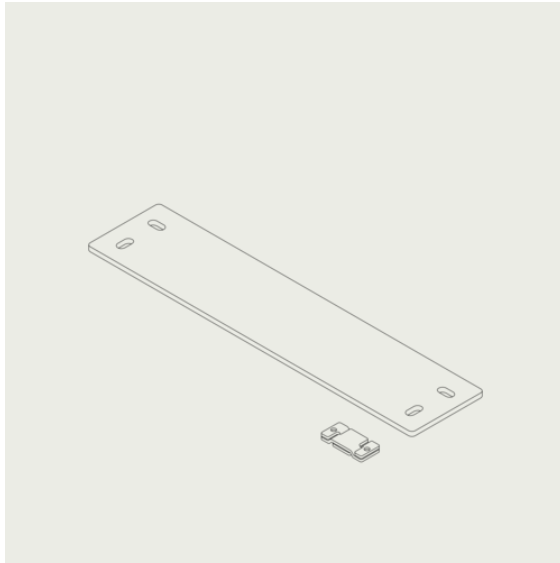

Shipper Colli 1  
Gross Weight (kg) 1.6  
Net Weight (kg) 1.46  
Warranty Period 5 years

Pattern No.	Color	Contract Price	Lead Time
<b>Ready-To-Ship US Warehouse</b>			
MLDINSU	Black	USD 39.00	-

# IN SITU MODULAR SOFA / FRAME CONFIGURATION - 2-SEATER

Shipper Colli 1  
 Gross Weight (kg) 21.9  
 Net Weight (kg) 18.24  
 Warranty Period 10 years

Pattern No.	Color	Contract Price	Lead Time
<b>Ready-To-Ship US Warehouse</b>			
MINS PF2C1	2-Seater Frame Configuration 1	USD 576.00	-
MINS PF2C2	2-Seater Frame Configuration 2	USD 576.00	-
MINS PF2C3	2-Seater Frame Configuration 3	USD 576.00	-
MINS PF2C4	2-Seater Frame Configuration 4	USD 614.00	-
MINS PF2C5	2-Seater Frame Configuration 5	USD 614.00	-
MINS PF2C6	2-Seater Frame Configuration 6	USD 614.00	-
MINS PF2C7	2-Seater Frame Configuration 7	USD 614.00	-

# IN SITU MODULAR SOFA / FRAME CONFIGURATION - 3-SEATER

Shipper Colli 1  
 Gross Weight (kg) 29.9  
 Net Weight (kg) 24.92  
 Warranty Period 10 years

Pattern No.	Color	Contract Price	Lead Time
<b>Ready-To-Ship US Warehouse</b>			
MINS PF3C1	3-Seater Frame Configuration 1	USD 866.00	-
MINS PF3C2	3-Seater Frame Configuration 2	USD 866.00	-
MINS PF3C3	3-Seater Frame Configuration 3	USD 866.00	-
MINS PF3C4	3-Seater Frame Configuration 4	USD 866.00	-
MINS PF3C5	3-Seater Frame Configuration 5	USD 866.00	-
MINS PF3C6	3-Seater Frame Configuration 6	USD 902.00	-
MINS PF3C7	3-Seater Frame Configuration 7	USD 902.00	-
MINS PF3C8	3-Seater Frame Configuration 8	USD 902.00	-
MINS PF3C9	3-Seater Frame Configuration 9	USD 902.00	-



# IN SITU MODULAR SOFA / FRAME CONFIGURATION - 4-SEATER

Shipper Colli 3  
Gross Weight (kg) 45.4  
Net Weight (kg) 37.94  
Warranty Period 10 years

Pattern No.	Color	Contract Price	Lead Time
<b>Ready-To-Ship US Warehouse</b>			
MINSPP4C1	4-Seater Frame Configuration 1	USD 1,206.00	-
MINSPP4C2	4-Seater Frame Configuration 2	USD 1,206.00	-
MINSPP4C3	4-Seater Frame Configuration 3	USD 1,206.00	-
MINSPP4C4	4-Seater Frame Configuration 4	USD 1,206.00	-
MINSPP4C5	4-Seater Frame Configuration 5	USD 1,206.00	-

# IN SITU MODULAR SOFA / FRAME CONFIGURATION - CORNER

Shipper Colli 5  
 Gross Weight (kg) 57.8  
 Net Weight (kg) 47.96  
 Warranty Period 10 years

Pattern No.	Color	Contract Price	Lead Time
<b>Ready-To-Ship US Warehouse</b>			
MINSPFCC1	Corner Frame Configuration 1	USD 1,570.00	-
MINSPFCC2	Corner Frame Configuration 2	USD 1,570.00	-
MINSPFCC3	Corner Frame Configuration 3	USD 1,570.00	-
MINSPFCC4	Corner Frame Configuration 4	USD 1,570.00	-
MINSPFCC5	Corner Frame Configuration 5	USD 1,570.00	-
MINSPFCC6	Corner Frame Configuration 6	USD 1,836.00	-
MINSPFCC7	Corner Frame Configuration 7	USD 1,836.00	-
MINSPFCC8	Corner Frame Configuration 8	USD 2,095.00	-
MINSPFCC9	Corner Frame Configuration 9	USD 2,095.00	-

# IN SITU MODULAR SOFA INDIVIDUAL PARTS



## All Variants

	Description	Pattern No.	Contract Price
In Situ Frames - Straight	1x80	M-INSFRM-S-80	289
	1x98	M-INSFRM-S-98	289
	2x80	M-INSFRM-S-8080	576
	2x98	M-INSFRM-S-9898	576
	3x80	M-INSFRM-S-808080	866
	1x80 + 1x98	M-INSFRM-S-8098	576
	1x80 + 2x98	M-INSFRM-S-809898	866
	2x80 + 1x98	M-INSFRM-S-808098	866
In Situ Frames - Chaise	1x98	M-INSFRM-L-98	289
In Situ Frames - Corner	1x98	M-INSFRM-C-98	289
In Situ Linking Bracket		M-LD-INSU	39

		Upholstery Grades									
		COM									
	Description	Pattern No.	A	B	C	E	R	T	U	V	W
In Situ Armrest Module	Left (A80)	M-INSAM-L	2,256	2,361	2,515	2,571	3,621	4,041	4,566	4,881	5,301
	Right (B80)	M-INSAM-R	2,256	2,361	2,515	2,571	3,621	4,041	4,566	4,881	5,301
In Situ Center Module	Centre (C80)	M-INSCTM	1,570	1,836	1,941	2,046	2,571	2,830	3,145	3,411	3,726
In Situ Ottoman Module	Ottoman (D80)	M-INSOTM	881	971	1,013	1,101	1,731	1,941	2,200	2,361	2,571
In Situ Corner Module	Corner (E98)	M-INSCOM	2,515	2,781	2,830	2,886	4,041	4,356	4,881	5,245	5,560
In Situ Open-Ended Module	Left (F98)	M-INSOEM-L	1,731	1,941	2,095	2,256	3,096	3,355	3,831	4,146	4,405
	Right (G98)	M-INSOEM-R	1,731	1,941	2,095	2,256	3,096	3,355	3,831	4,146	4,405
In Situ Armrest Lounge Module	Left (H98)	M-INSALM-L	2,830	3,145	3,355	3,516	5,245	5,721	6,295	6,820	7,296
	Right (I98)	M-INSALM-R	2,830	3,145	3,355	3,516	5,245	5,721	6,295	6,820	7,296
In Situ Cushion	27.6" x 11.8"	M-INSCUS-2610	167	198	236	257	394	450	597	555	587
	27.6" x 19.7"	M-INSCUS-2618	226	236	289	310	660	719	929	950	982

## Upholstery Options

A	B	C	E	R	T	U	V	W
Ocean (M161)*	Fiord (M155) Grain (M12659) Manner (M12665) Re-Wool (M4586) Sabi (M8404)	Hallingdal (M146)	Acca (M12660) Beck (M6376) Divina (M150) Divina MD (M147) Divina Melange (M135) Ecriture (M10767) Hearth (M12664) Twill Weave (M142) Vidar (M158)	Easy Leather (M141)	Refine Leather (M136)	Endure	Grace Leather (M12374)	Allure Leather

\*Notes:  
Ocean - Color 3, 21, 32, 50, 52, 80 & 601  
Clay - Color 1, 2, 3, 4, 5, 6, 7, 8, 9, 10, 11, 12, 13, 14, 15, 16 & 17

## HOW TO CONFIGURE

See the In Situ intro page for how to configure or use the online planner on: [planner.muuto.com/in-situ](http://planner.muuto.com/in-situ)

# LINEAR STEEL SERIES

FOR MORE INFORMATION,  
EXPLORE BELOW

- ↗ [Product Fact Sheet](#)
- ↗ [Images](#)
- ↗ [Architect Files](#)
- ↗ [Assembly Instructions](#)
- ↗ [Product Declaration](#)

# LINEAR STEEL TABLE / 140 X 75 CM / 55.1 X 29.5"

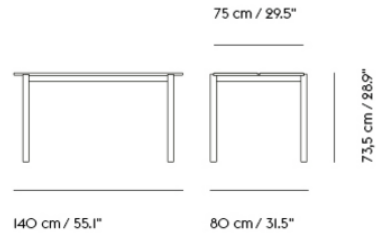

**Shipper Colli** 3  
**Gross Weight (kg)** 46.25  
**Net Weight (kg)** 40  
**Warranty Period** 10 years

Pattern No.	Color	Contract Price	Lead Time
<b>Ready-To-Ship US Warehouse</b>			
MLINST5530-BLCK	Anthracite Black	USD 1,675.00	-
MLINST5530-BORG	Burnt Orange	USD 1,675.00	-
MLINST5530-DKGN	Dark Green	USD 1,675.00	-
MLINST5530-GREY	Grey	USD 1,675.00	-
MLINST5530-PABU	Pale Blue	USD 1,675.00	-
<b>Extras</b>			
MLINSG	Plastic glides for Linear Steel Table and Bench - Black	USD 21.00	-
MLINSS	Adjustable Feet for Linear Steel Table & Bench	USD 34.00	-
MLINSM	Linear Steel Ground Mounting Kit	USD 142.00	-
MLINSC5530	Outdoor Cover for Linear Steel Table 140 x 75 CM / 55.1 x 29.5	USD 167.00	-

# LINEAR STEEL TABLE / 200 X 75 CM / 78.7 X 29.5"

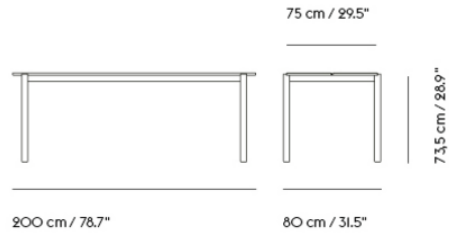

**Shipper Colli** 3  
**Gross Weight (kg)** 58.35  
**Net Weight (kg)** 51  
**Warranty Period** 10 years

Pattern No.	Color	Contract Price	Lead Time
<b>Ready-To-Ship US Warehouse</b>			
MLINST7930-BLCK	Anthracite Black	USD 1,885.00	-
MLINST7930-BORG	Burnt Orange	USD 1,885.00	-
MLINST7930-DKGN	Dark Green	USD 1,885.00	-
MLINST7930-GREY	Grey	USD 1,885.00	-
MLINST7930-WHIT	Off-White ***	USD 1,885.00	-
MLINST7930-PABU	Pale Blue	USD 1,885.00	-
<b>Extras</b>			
MLINSG	Plastic glides for Linear Steel Table and Bench - Black	USD 21.00	-
MLINSS	Adjustable Feet for Linear Steel Table & Bench	USD 34.00	-
MLINSM	Linear Steel Ground Mounting Kit	USD 142.00	-
MLINSC7930	Linear Steel Cover - Black - 200 x 75cm / 78.7 x 29.5"	USD 184.00	-

**LINEAR STEEL TABLE / 220 X 90 CM / 86.6 X 35.5"**

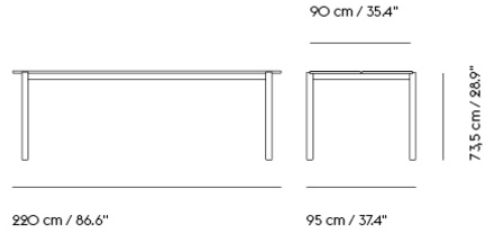

Shipper Colli 3  
 Gross Weight (kg) 73.1  
 Net Weight (kg) 62  
 Warranty Period 10 years

Pattern No.	Color	Contract Price	Lead Time
<b>Ready-To-Ship US Warehouse</b>			
MLINST8635-BLCK	Anthracite Black	USD 2,256.00	-
MLINST8635-BORG	Burnt Orange	USD 2,256.00	-
MLINST8635-DKGN	Dark Green	USD 2,256.00	-
MLINST8635-GREY	Grey	USD 2,256.00	-
MLINST8635-PABU	Pale Blue	USD 2,256.00	-
<b>Extras</b>			
MLINSG	Plastic glides for Linear Steel Table and Bench - Black	USD 21.00	-
MLINSS	Adjustable Feet for Linear Steel Table & Bench	USD 34.00	-
MLINSM	Linear Steel Ground Mounting Kit	USD 142.00	-
MODCV-BLCK	Outdoor Cover for 70/70 Outdoor Table and Linear Steel Table 220 x 90 CM / 86.6 x 35.5"	USD 299.00	-

# LINEAR STEEL BENCH / 110 X 34 CM / 43.3 X 15.4"

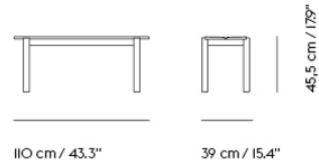

**Shipper Colli** 2  
**Gross Weight (kg)** 30.132  
**Net Weight (kg)** 22  
**Warranty Period** 10 years

Pattern No.	Color	Contract Price	Lead Time
<b>Ready-To-Ship US Warehouse</b>			
MLINSB43-BLCK	Anthracite Black	USD 877.00	-
MLINSB43-BORG	Burnt Orange	USD 877.00	-
MLINSB43-DKGN	Dark Green	USD 877.00	-
MLINSB43-GREY	Grey	USD 877.00	-
MLINSB43-WHIT	Off-White ***	USD 877.00	-
MLINSB43-PABU	Pale Blue	USD 877.00	-
<b>Extras</b>			
MLINSG	Plastic glides for Linear Steel Table and Bench - Black	USD 21.00	-
MLINSS	Adjustable Feet for Linear Steel Table & Bench	USD 34.00	-
MLINSM	Linear Steel Ground Mounting Kit	USD 142.00	-
MLINSB43PD-DKGY	Bench Seat Pad - Twitell - Dark Grey	USD 198.00	-
MLINSB43PD-LTGY	Bench Seat Pad - Twitell - Light Grey	USD 198.00	-



**LINEAR STEEL BENCH / 170 X 34 CM / 66.9 X 15.4"**

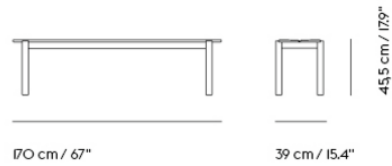

**Shipper Colli** 2  
**Gross Weight (kg)** 27  
**Net Weight (kg)** 25  
**Warranty Period** 10 years

Pattern No.	Color	Contract Price	Lead Time
<b>Ready-To-Ship US Warehouse</b>			
MLINSB67-BLCK	Anthracite Black	USD 1,206.00	-
MLINSB67-BORG	Burnt Orange	USD 1,206.00	-
MLINSB67-DKGN	Dark Green	USD 1,206.00	-
MLINSB67-GREY	Grey	USD 1,206.00	-
MLINSB67-WHIT	Off-White ***	USD 1,206.00	-
MLINSB67-PABU	Pale Blue	USD 1,206.00	-
<b>Extras</b>			
MLINSG	Plastic glides for Linear Steel Table and Bench - Black	USD 21.00	-
MLINSS	Adjustable Feet for Linear Steel Table & Bench	USD 34.00	-
MLINSM	Linear Steel Ground Mounting Kit	USD 142.00	-
MLINSB67PD-DKGY	Bench Seat Pad - Twitell - Dark Grey	USD 272.00	-
MLINSB67PD-LTGY	Bench Seat Pad - Twitell - Light Grey	USD 272.00	-

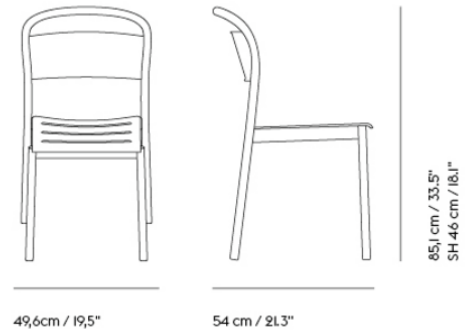

<b>Shipper Colli</b>	1
<b>Gross Weight (kg)</b>	11.45
<b>Net Weight (kg)</b>	8.05
<b>Stacking Information</b>	Linear Steel Side Chair stacks up to 5 chairs on the floor.
<b>Warranty Period</b>	5 years

Pattern No.	Color	Contract Price	Lead Time
<b>Ready-To-Ship US Warehouse</b>			
MLINSCHS-BLCK	Anthracite Black	USD 450.00	-
MLINSCHS-BORG	Burnt Orange	USD 450.00	-
MLINSCHS-DKGN	Dark Green	USD 450.00	-
MLINSCHS-GREY	Grey	USD 450.00	-
MLINSCHS-OWHIT	Off-White ***	USD 450.00	-
MLINSCHS-PABU	Pale Blue	USD 450.00	-
<b>Extras</b>			
MLINSCHRPD-DKGY	Chair Seat Pad - Twitell - Dark Grey	USD 100.00	-
MLINSCHRPD-LTGY	Chair Seat Pad - Twitell - Light Grey	USD 100.00	-

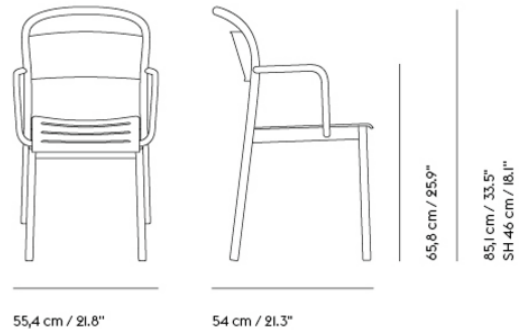

<b>Shipper Colli</b>	1
<b>Gross Weight (kg)</b>	12.4
<b>Net Weight (kg)</b>	8.2
<b>Stacking Information</b>	Linear Steel Armchair stacks up to 5 chairs on the floor.
<b>Warranty Period</b>	5 years

Pattern No.	Color	Contract Price	Lead Time
<b>Ready-To-Ship US Warehouse</b>			
MLINSCHA-BLCK	Anthracite Black	USD 488.00	-
MLINSCHA-BORG	Burnt Orange	USD 488.00	-
MLINSCHA-DKGN	Dark Green	USD 488.00	-
MLINSCHA-GREY	Grey	USD 488.00	-
MLINSCHA-OWHIT	Off-White ***	USD 488.00	-
MLINSCHA-PABU	Pale Blue	USD 488.00	-
<b>Extras</b>			
MLINSCHRPD-DKGY	Chair Seat Pad - Twitell - Dark Grey	USD 100.00	-
MLINSCHRPD-LTGY	Chair Seat Pad - Twitell - Light Grey	USD 100.00	-

**LINEAR STEEL CAFÉ TABLE / 70 X 70 H:  
73 CM / 27.6 X 27.6 H: 28.7"**

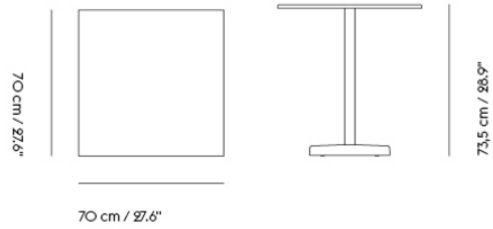

Shipper Colli 3  
 Gross Weight (kg) 28.704  
 Net Weight (kg) 26.2  
 Warranty Period 10 years

Pattern No.	Color	Contract Price	Lead Time
<b>Ready-To-Ship US Warehouse</b>			
MLINSCTR272728-BLCK	Anthracite Black	USD 933.00	-
MLINSCTR272728-BORG	Burnt Orange	USD 933.00	-
MLINSCTR272728-DKGN	Dark Green	USD 933.00	-
MLINSCTR272728-GREY	Grey	USD 933.00	-
MLINSCTR272728-PABU	Pale Blue	USD 933.00	-

# LINEAR STEEL CAFÉ TABLE / 70 X 70 H: 95 CM / 27.6 X 27.6 H: 37.4"

250

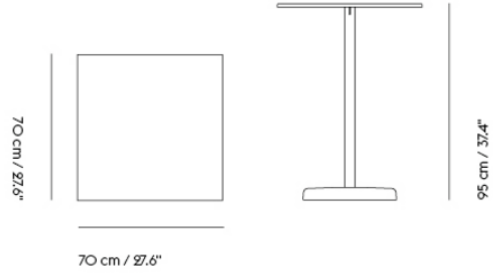

**Shipper Colli** 3  
**Gross Weight (kg)** 29.704  
**Net Weight (kg)** 27  
**Warranty Period** 10 years

Pattern No.	Color	Contract Price	Lead Time
<b>Ready-To-Ship US Warehouse</b>			
MLINSCTR272737-BLCK	Anthracite Black	USD 971.00	-
MLINSCTR272737-BORG	Burnt Orange	USD 971.00	-
MLINSCTR272737-DKGN	Dark Green	USD 971.00	-
MLINSCTR272737-GREY	Grey	USD 971.00	-
MLINSCTR272737-PABU	Pale Blue	USD 971.00	-

**LINEAR STEEL CAFÉ TABLE / 70 X 70 H:  
105 CM / 27.6 X 27.6 H: 41.3"**

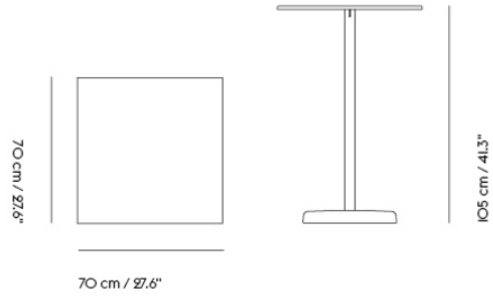

Shipper Colli 3  
 Gross Weight (kg) 30.104  
 Net Weight (kg) 27.3  
 Warranty Period 10 years

Pattern No.	Color	Contract Price	Lead Time
<b>Ready-To-Ship US Warehouse</b>			
MLINSCTR272741-BLCK	Anthracite Black	USD 971.00	-
MLINSCTR272741-BORG	Burnt Orange	USD 971.00	-
MLINSCTR272741-DKGN	Dark Green	USD 971.00	-
MLINSCTR272741-GREY	Grey	USD 971.00	-
MLINSCTR272741-PABU	Pale Blue	USD 971.00	-

# LINEAR STEEL CAFÉ TABLE / Ø 70 H: 73 CM / 27.6 H: 28.7"

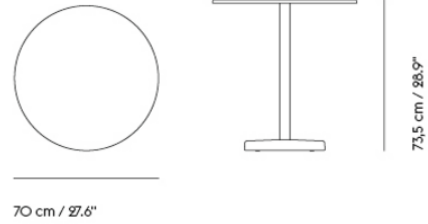

**Shipper Colli** 3  
**Gross Weight (kg)** 26.704  
**Net Weight (kg)** 24.2  
**Warranty Period** 10 years

Pattern No.	Color	Contract Price	Lead Time
<b>Ready-To-Ship US Warehouse</b>			
MLINSCTO2728-BLCK	Anthracite Black	USD 933.00	-
MLINSCTO2728-BORG	Burnt Orange	USD 933.00	-
MLINSCTO2728-DKGN	Dark Green	USD 933.00	-
MLINSCTO2728-GREY	Grey	USD 933.00	-
MLINSCTO2728-PABU	Pale Blue	USD 933.00	-

# LINEAR STEEL CAFÉ TABLE / Ø 70 H: 95 CM / 27.6 H: 37.4"

253

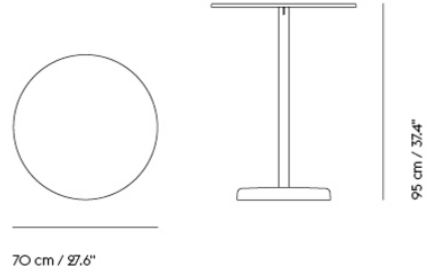

Shipper Colli 3  
 Gross Weight (kg) 27.704  
 Net Weight (kg) 25  
 Warranty Period 10 years

Pattern No.	Color	Contract Price	Lead Time
<b>Ready-To-Ship US Warehouse</b>			
MLINSCTO2737-BLCK	Anthracite Black	USD 971.00	-
MLINSCTO2737-BORG	Burnt Orange	USD 971.00	-
MLINSCTO2737-DKGN	Dark Green	USD 971.00	-
MLINSCTO2737-GREY	Grey	USD 971.00	-
MLINSCTO2737-PABU	Pale Blue	USD 971.00	-



LINEAR STEEL CAFÉ TABLE / Ø 70 H: 105  
CM / 27.6 H: 41.3"

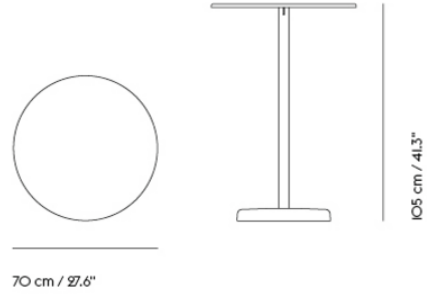

Shipper Colli 3  
 Gross Weight (kg) 28.104  
 Net Weight (kg) 25.3  
 Warranty Period 10 years

Pattern No.	Color	Contract Price	Lead Time
<b>Ready-To-Ship US Warehouse</b>			
MLINSCTO2741-BLCK	Anthracite Black	USD 971.00	-
MLINSCTO2741-BORG	Burnt Orange	USD 971.00	-
MLINSCTO2741-DKGN	Dark Green	USD 971.00	-
MLINSCTO2741-GREY	Grey	USD 971.00	-
MLINSCTO2741-PABU	Pale Blue	USD 971.00	-

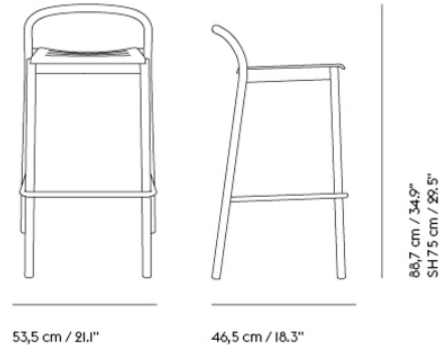

Shipper Colli	1
Gross Weight (kg)	12.7
Net Weight (kg)	9.5
Stacking Information	Linear Steel Bar Stool stacks up to 5 stools on the floor.
Warranty period	5 years

Pattern No.	Color	Contract Price	Lead Time
<b>Ready-To-Ship US Warehouse</b>			
MLINSSTB-BLCK	Anthracite Black	USD 530.00	-
MLINSSTB-BORG	Burnt Orange	USD 530.00	-
MLINSSTB-DKGN	Dark Green	USD 530.00	-
MLINSSTB-GREY	Grey	USD 530.00	-
MLINSSTB-PABU	Pale Blue	USD 530.00	-
<b>Extras</b>			
MLINSSTPD-DKGY	Bar/Counter Seat Pad - Twitell - Dark Grey	USD 89.00	-
MLINSSTPD-LTGY	Bar/Counter Seat Pad - Twitell - Light Grey	USD 89.00	-

**LINEAR STEEL COUNTER STOOL 65 CM / 25.6"**

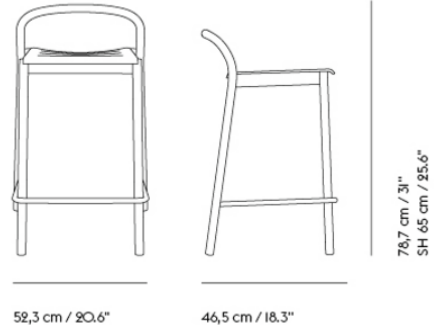

<b>Shipper Colli</b>	1
<b>Gross Weight (kg)</b>	12.1
<b>Net Weight (kg)</b>	8.9
<b>Stacking Information</b>	Linear Steel Counter Stool stacks up to 5 stools on the floor.
<b>Warranty period</b>	5 years

Pattern No.	Color	Contract Price	Lead Time
<b>Ready-To-Ship US Warehouse</b>			
MLINSSTC-BLCK	Anthracite Black	USD 530.00	-
MLINSSTC-BORG	Burnt Orange	USD 530.00	-
MLINSSTC-DKGN	Dark Green	USD 530.00	-
MLINSSTC-GREY	Grey	USD 530.00	-
MLINSSTC-PABU	Pale Blue	USD 530.00	-
<b>Extras</b>			
MLINSSTPD-DKGY	Bar/Counter Seat Pad - Twitell - Dark Grey	USD 89.00	-
MLINSSTPD-LTGY	Bar/Counter Seat Pad - Twitell - Light Grey	USD 89.00	-

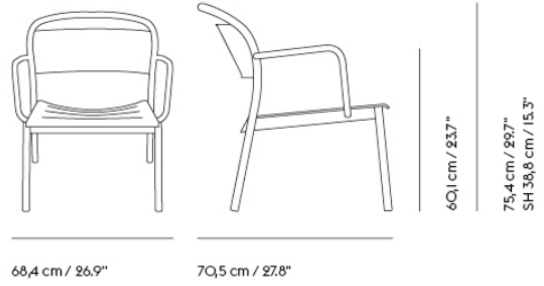

Shipper Colli	1
Gross Weight (kg)	16.35
Net Weight (kg)	13.2
Stacking Information	Linear Steel Lounge Chair stacks up to 4 chairs on the floor.
Warranty Period	10 years

Pattern No.	Color	Contract Price	Lead Time
<b>Ready-To-Ship US Warehouse</b>			
MLINSLC-BLCK	Anthracite Black	USD 929.00	-
MLINSLC-BORG	Burnt Orange	USD 929.00	-
MLINSLC-DKGN	Dark Green	USD 929.00	-
MLINSLC-GREY	Grey	USD 929.00	-
MLINSLC-PABU	Pale Blue	USD 929.00	-
<b>Extras</b>			
MLINSLCPD-DKGY	Lounge Chair Seat Pad - Twitell - Dark Grey	USD 121.00	-
MLINSLCPD-LTGY	Lounge Chair Seat Pad - Twitell - Light Grey	USD 121.00	-

**LINEAR STEEL COFFEE TABLE / Ø 42 H: 47  
CM / 16.5 H: 18.5"**

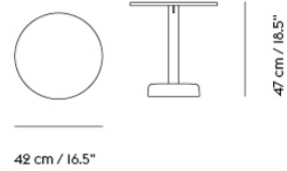

Shipper Colli 3  
 Net Weight (kg) 7.4  
 Warranty period 10 years

Pattern No.	Color	Contract Price	Lead Time
<b>Ready-To-Ship US Warehouse</b>			
MLINSCFT01719-BLCK	Anthracite Black	USD 660.00	-
MLINSCFT01719-BORG	Burnt Orange	USD 660.00	-
MLINSCFT01719-DKGN	Dark Green	USD 660.00	-
MLINSCFT01719-GREY	Grey	USD 660.00	-
MLINSCFT01719-PABU	Pale Blue	USD 660.00	-

**LINEAR STEEL COFFEE TABLE / Ø 70 H:  
40 CM / 27.5 H: 15.5"**

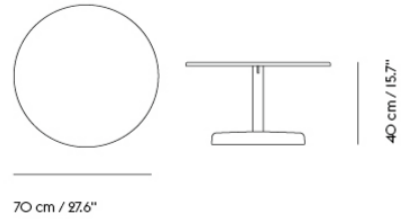

Shipper Colli 3  
 Net Weight (kg) 23  
 Warranty period 10 years

Pattern No.	Color	Contract Price	Lead Time
<b>Ready-To-Ship US Warehouse</b>			
MLINSCFT02716-BLCK	Anthracite Black	USD 797.00	-
MLINSCFT02716-BORG	Burnt Orange	USD 797.00	-
MLINSCFT02716-DKGN	Dark Green	USD 797.00	-
MLINSCFT02716-GREY	Grey	USD 797.00	-
MLINSCFT02716-PABU	Pale Blue	USD 797.00	-

# LINEAR SYSTEM SERIES

FOR MORE INFORMATION,  
EXPLORE BELOW

- ↗ [Product Fact Sheet](#)
- ↗ [Images](#)
- ↗ [Architect Files](#)
- ↗ [Assembly Instructions](#)
- ↗ [Product Declaration](#)
- ↗ [Product Planner](#)

The Linear System Series brings a new perspective to the evolving needs of the modern workspaces, hospitality settings and educational institutions through its configurable design across tables, lighting, screens and trays alongside its custom integrated power solution, allowing one to tailor the design to the exact needs of any space.

**Option A** — Choose between one of our predesigned table configurations and simply add your desired lamps and accessories.

**Option B** — Create your own configuration from scratch and add lamps and accessories from there.

## Option A — Predesigned Table Configurations

### STEP 1. TABLES

Select either the Linear System Table or one of two Linear System Table Configurations.

**Note**  
Different finishes of tabletops cannot be mixed as they might vary in thickness.

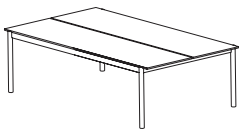
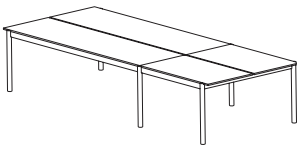
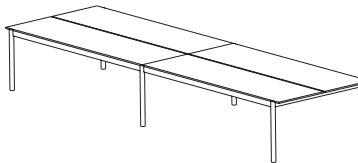
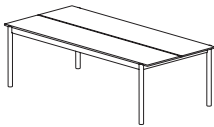
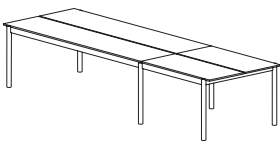
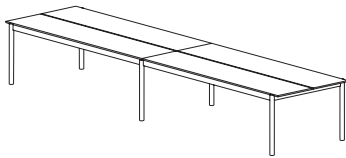
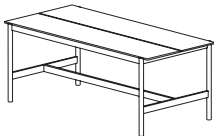
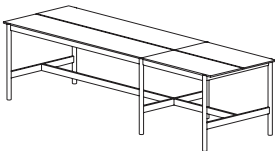
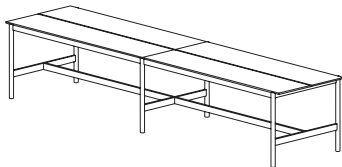
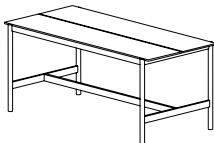
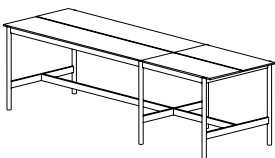
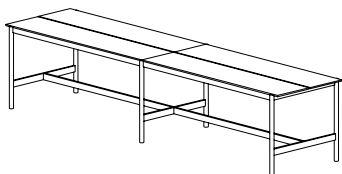
Table	Configuration 1	Configuration 2
<p><b>Linear System Table W142</b></p> <p>Height — 74 cm / 29.1" Table top width — 142 cm / 55.9" Total width — 146.9 cm / 57.8" No of Persons — 4-6</p>  <p>L 240 cm / 94.5"</p>	 <p>L 360 cm / 141.7"</p>	 <p>L 480 cm / 189"</p>
<p><b>Linear System Table W110</b></p> <p>Height — 74 cm / 29.1" Table top width — 110 cm / 43.3" Total width — 115 cm / 45.3" No of Persons — 4-6</p>  <p>L 240 cm / 94.5"</p>	 <p>L 360 cm / 141.7"</p>	 <p>L 480 cm / 189"</p>
<p><b>Linear System Table High H95</b></p> <p>Height — 95 cm / 37.4" Table top width — 110 cm / 43.3" Total width — 115 cm / 45.3" No of Persons — 4-6</p>  <p>L 240 cm / 94.5"</p>	 <p>L 360 cm / 141.7"</p>	 <p>L 480 cm / 189"</p>
<p><b>Linear System Table High H105</b></p> <p>Height — 105 cm / 41.4" Table top width — 110 cm / 43.3" Total width — 115 cm / 45.3" No of Persons — 4-6</p>  <p>L 240 cm / 94.5"</p>	 <p>L 360 cm / 141.7"</p>	 <p>L 480 cm / 189"</p>

OPTION A  
1. TABLES / 2. ACCESSORIES / 3. LIGHTING / 4. TABLE POWER OUTLET / 5. INTEGRATED POWER / 6. CABLE TRAY



## STEP 2. ACCESSORIES

### Trays

Add your desired number of Linear System Trays.

**Note**  
Trays must be mounted at least 5 cm / 2" from the table edge.

#### Linear System Tray — Ø24 cm / 9.5"

Height — 15,6 cm / 6.2"  
Diameter — 24 cm / 9.5"



#### Linear System Tray — Ø36 cm / 14.2"

Height — 9,6 cm / 3.8"  
Diameter — 36 cm / 14.2"



#### Linear System Tray — 75 cm / 29.5"

Height — 15 cm / 5.9"  
Width — 21 cm / 8.3"  
Length — 75 cm / 29.5"

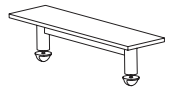

### Screens

Add your desired number of Linear System Screens.

**Note**  
We recommend that screens are mounted to the table. They must be placed at least 5 cm / 2" from the table edge.

#### Linear System Screen — 75 cm / 29.5"

Height — 35 cm / 13.8"  
Width — 15 cm / 5.9"  
Length — 75 cm / 29.5"

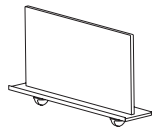

#### Linear System Screen — 125 cm / 49.2"

Height — 35 cm / 13.8"  
Width — 15 cm / 5.9"  
Length — 125 cm / 49.2"

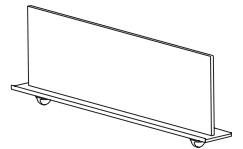

#### Linear System Screen — 178 cm / 70.1"

Height — 35 cm / 13.8"  
Width — 15 cm / 5.9"  
Length — 178 cm / 70.1"

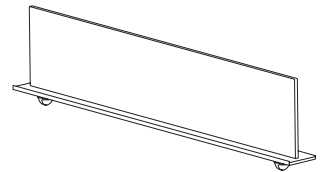

**Note**  
Please note that only the Linear System Screen 125 cm / 49.2" can be mounted across the table.

### Example

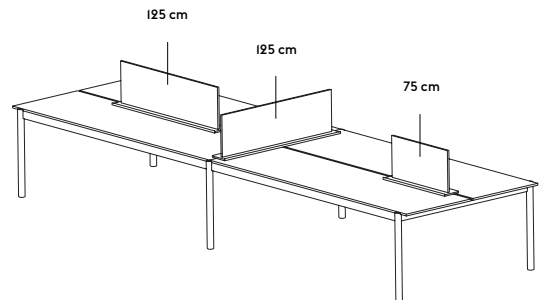

OPTION A  
1. TABLES / 2. ACCESSORIES / 3. LIGHTING / 4. TABLE POWER OUTLET / 5. INTEGRATED POWER / 6. CABLE TRAY

## STEP 3. LIGHTING

Add your desired number of Linear Lamps.

**Note**  
The Linear Table Lamp has one USB-C plug.

### Linear Table Lamp

Height — 36,5 cm / 14.4"  
Width — 23,2 cm / 9.1"  
Depth — 16,5 cm / 6.5"



**Note**  
Linear Mounted Lamp must be mounted at least 5 cm / 2" from the table edge.

Please be aware that the Linear Mounted Lamp and Table Power Outlet, both designed for the Linear System Series, have a special power solution with special plugs.

### Linear Mounted Lamp — 23,2 cm / 9.1"

Height — 36,5 cm / 14.4"  
Width — 23,2 cm / 9.1"  
Depth — 10,7 cm / 4.2"

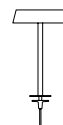

### Linear Mounted Lamp — 209,2 cm / 82.4"

Height — 70,7 cm / 27.8"  
Width — 209,2 cm / 82.4"  
Depth — 10,7 cm / 4.2"



### Linear Pendant Lamp — 87,2 cm / 34.3"

Height — 5,4 cm / 2.1"  
Width — 87,2 cm / 34.3"  
Depth — 10,7 cm / 4.2"



### Linear Pendant Lamp — 169,2 cm / 66.6"

Height — 5,4 cm / 2.1"  
Width — 169,2 cm / 66.6"  
Depth — 10,7 cm / 4.2"



## STEP 4. TABLE POWER OUTLETS

Specify your desired number of Table Power Outlets. Each Table Power Outlet has two outlets (one at each end) and one USB-A and USB-C plug to which standard plugs can be connected.

**Note**  
Linear System Table Power Outlet must be mounted at least 5 cm / 2" from the table edge.

### Linear System Table Power Outlet — EU, US

Height — 7 cm / 2.8"  
Width — 7 cm / 2.8"  
Length — 18 cm / 7.1"

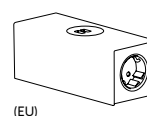

(EU)

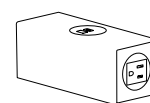

(US)

### OPTION A

1. TABLES / 2. ACCESSORIES / 3. LIGHTING / 4. TABLE POWER OUTLET / 5. INTEGRATED POWER / 6. CABLE TRAY

## STEP 5. INTEGRATED POWER FOR MOUNTED LAMPS & TABLE POWER OUTLETS

If you'd like to add the Mounted Lamp(s) or Table Power Outlet(s), select the Table Power Kit for the Linear System Table or one of the three Power Configurations that match your selected Linear System Table Configuration.

**Note**  
Each Distribution Block has four outlets to which up to four Linear Mounted Lamps or Linear System Table Power Outlets can be plugged in.

Distribution Block — 4-way

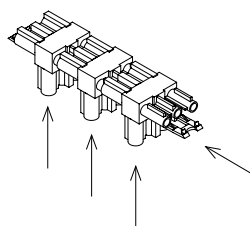

US cable  
500 cm / 197" cable

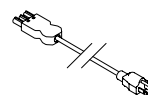

### Linear System Table

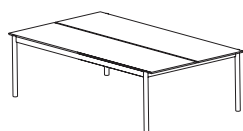

### Linear System Power

Power Kit (1 pcs)  
500 cm / 197" cable (US)  
Distribution Block

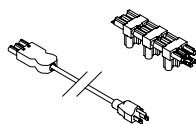

### Linear System Table Configuration 1

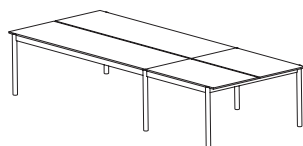

### Linear System Power

Power Kit (1 pcs)  
500 cm / 197" cable (US)  
Distribution Block

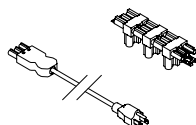

### Linear System Table Configuration 2

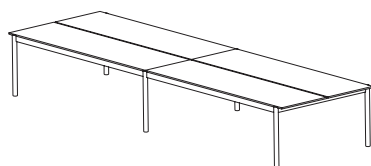

### Linear System Power Configuration 2

Power Kit (1 pcs)  
500 cm / 197" cable (US)  
Distribution Block

Power Kit (1 pcs)  
500 cm / 197" cable (US)  
Distribution Block

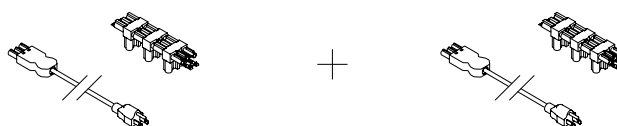

OPTION A

1. TABLES / 2. ACCESSORIES / 3. LIGHTING / 4. TABLE POWER OUTLET / 5. INTEGRATED POWER / 6. CABLE TRAY

**Note**  
The Integrated Power for Linear System Series has unique internal plugs to provide a slim and discreet look. This means that you cannot connect a standard plug to the power without using the Linear Table Power Outlet or changing the standard plug to a matching plug, being the Wieland GSTI8I3 plug.

The Linear Mounted Lamps must be connected to the integrated Power Kit.

Wieland GSTI8I3 plug

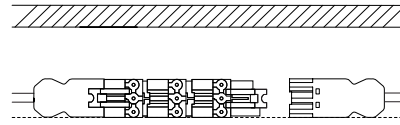

Standard plug (US)

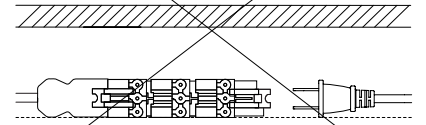

1. Connecting using the Wieland GSTI8I3 plug

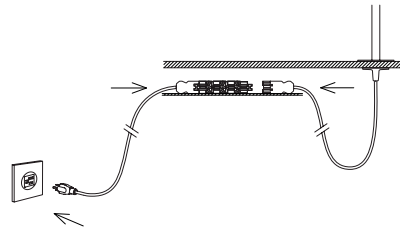

2. Connecting using a standard plug to the Linear Table Power Outlet

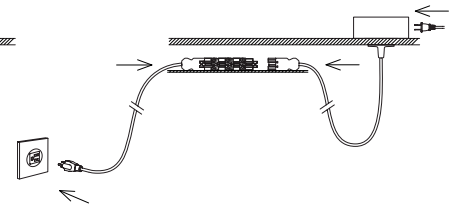

**LINEAR TABLE LAMP ONLY**

The Linear Table Lamp can either be connected to a standard wall plug or the Table Power Outlet.

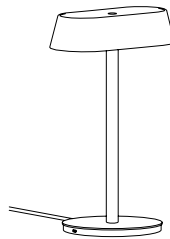

Standard plug

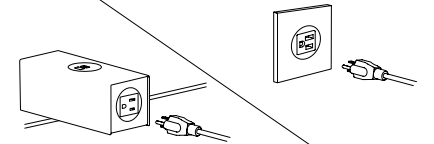

Linear Table Power Outlet

Alternatively, you can connect it to the integrated Power Kit by replacing the plug with a custom Wieland GSTI8I3 plug that is included with the lamp. Kindly refer to the Linear Table Lamp manual for instructions.

Integrated Table Power Kit (Wieland GSTI8I3 plug)

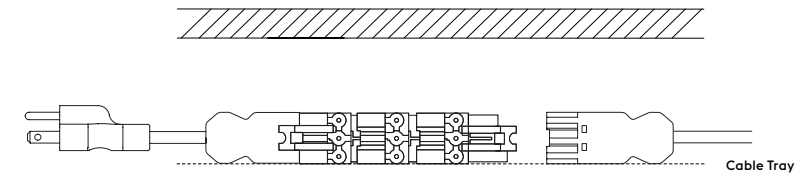

**OPTION A**

1. TABLES / 2. ACCESSORIES / 3. LIGHTING / 4. TABLE POWER OUTLET / 5. INTEGRATED POWER / 6. CABLE TRAY

## STEP 6. CABLE TRAYS

We recommend using 1 Cable Tray for the End Module – 120 cm / 47.2" and up to 3 Cable Trays for the Linear Table, End Module – 240 cm / 94.2" and the Middle Module – 240 cm / 94.2".

### Linear System Cable Tray

Height – 3 cm / 1.2"  
 Width – 22 cm / 8.7"  
 Depth – 60 cm / 23.7"

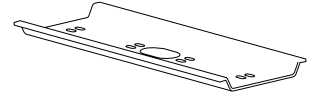

### Example:

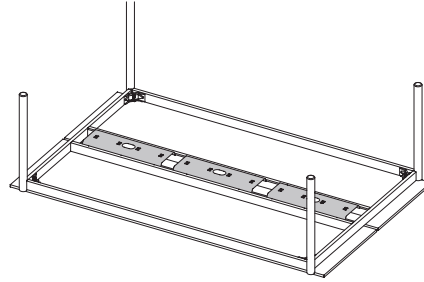

Linear System Table – 240 cm / 94.5"

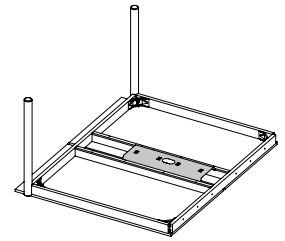

Linear System End Module – 120 cm / 47.2"

### OPTION A

1. TABLES / 2. ACCESSORIES / 3. LIGHTING / 4. TABLE POWER OUTLET / 5. INTEGRATED POWER / 6. CABLE TRAY

## Option B — Create your own configuration

### STEP 1. TABLES

#### A)

A configuration must always have End Modules in each end.

Start by defining the total length of your desired configuration, then select two table ends.

**Note**

Different finishes of tabletops cannot be mixed as they might vary in thickness.

#### Linear System End Module — 240 cm / 94.5"

Height — 74 cm / 29.1";  
Width — 146,9 cm / 57.8"  
Length — 240 cm / 94.5"  
No of Persons — 4-6



Height — 74 cm / 29.1";  
Width — 110 cm / 43.3";  
Length — 240 cm / 94.5"  
No of Persons — 4-6



Height - 95 cm / 37.4"  
Width - 110 cm / 43.3"  
Length - 240 cm / 94.5"  
No of Persons - 4-6

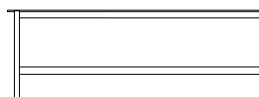

Height - 105 cm / 41.4"  
Width - 110 cm / 43.3"  
Length - 240 cm / 94.5"  
No of Persons - 4-6

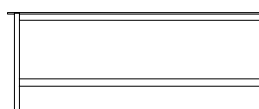

#### Linear System End Module — 120 cm / 47.2"

Height - 74 cm / 29.1"  
Width - 110 cm / 43.3"  
Length - 120 cm / 47.2"  
No of Persons - 2

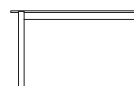

Height - 74 cm / 29.1"  
Width - 146,9 cm / 57.8"  
Length - 120 cm / 47.2"  
No of Persons - 2



Height - 95 cm / 37.4"  
Width - 110 cm / 43.3"  
Length - 120 cm / 47.2"  
No of Persons - 2

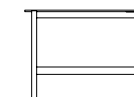

Height - 105 cm / 41.4"  
Width - 110 cm / 43.3"  
Length - 120 cm / 47.2"  
No of Persons - 2

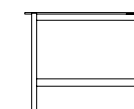

#### B)

Next, add the second, and final, End Module or your desired number of Middle Modules, only available in 240 cm / 94.5" length but in 2 different widths (110 cm / 43.3" and 142 cm / 55.9").

**Note**

Please note that it is not possible to connect more than two End Modules.

#### Linear System Middle Module — 240 cm / 94.5"

Width — 110 cm / 43.3";  
142 cm / 55.9"  
Length — 240 cm / 94.5"  
No of Persons — 4-6



#### C)

Next, you must order 1 set of Connecting Legs every time two modules are connected.

**Note**

95cm / 37.4" and 105cm / 41.4" Connecting Legs can only be connected to 110cm / 43.3" width tabletops (not to 142 cm/55.9" width tabletops).

#### Linear System Connecting Legs

Height — 74 cm / 29.1"  
95 cm / 37.4"  
105 cm / 41.4"

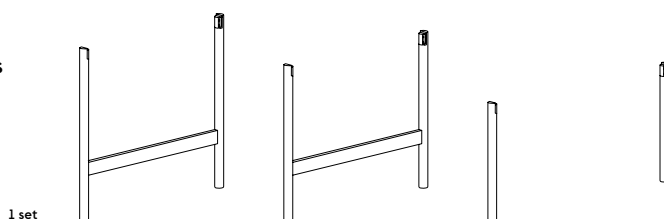

If you'd like a configuration of one End Module — 240 cm / 94.5" and one Middle Module — 240 cm / 94.5" and one End Module — 240 cm / 94.5", you must order two sets of Connecting Legs, as shown in the illustration.

#### Example

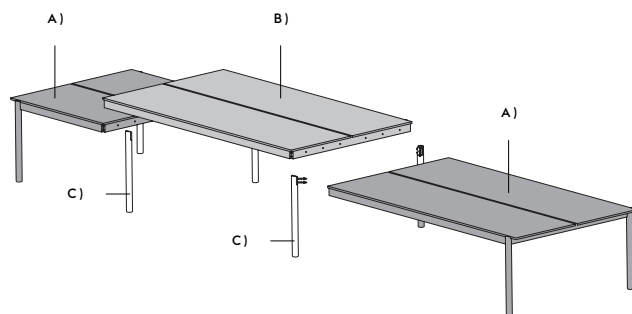

OPTION B

1. TABLES / 2. ACCESSORIES / 3. LIGHTING / 4. TABLE POWER OUTLET / 5. INTEGRATED POWER / 6. CABLE TRAY

## STEP 2. ACCESSORIES

### Trays

Add your desired number of Linear System Trays.

**Note**

Trays must be mounted at least 5 cm / 2" from the table edge.

### Linear System Tray — Ø24 cm / 9.5"

Height — 15,6 cm / 6.2"  
Diameter — 24 cm / 9.5"



### Linear System Tray — Ø36 cm / 14.2"

Height — 9,6 cm / 3.8"  
Diameter — 36 cm / 14.2"



### Linear System Tray — 75 cm / 29.5"

Height — 15 cm / 5.9"  
Width — 21 cm / 8.3"  
Length — 75 cm / 29.5"

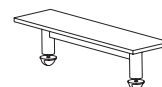

### Screens

Add your desired number of Linear System Screens.

**Note**

We recommend that screens are mounted to the table. They must be placed at least 5 cm / 2" from the table edge.

### Linear System Screen — 75 cm / 29.5"

Height — 35 cm / 13.8"  
Width — 15 cm / 5.9"  
Length — 75 cm / 29.5"

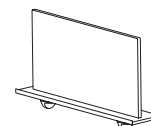

### Linear System Screen — 125 cm / 49.2"

Height — 35 cm / 13.8"  
Width — 15 cm / 5.9"  
Length — 125 cm / 49.2"

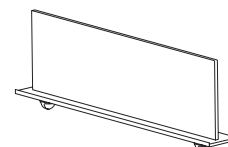

### Linear System Screen — 178 cm / 70.1"

Height — 35 cm / 13.8"  
Width — 15 cm / 5.9"  
Length — 178 cm / 70.1"

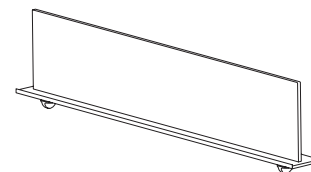

**Note**

Please note that only the Linear System Screen 125 cm / 49.2" can be mounted across the table.

### Example

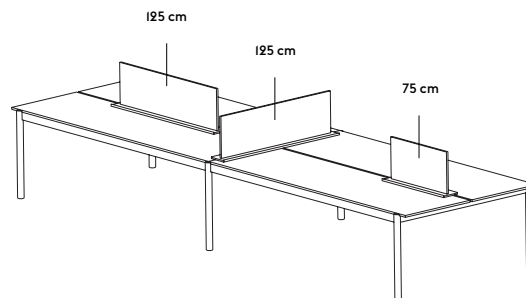

OPTION B

1. TABLES / 2. ACCESSORIES / 3. LIGHTING / 4. TABLE POWER OUTLET / 5. INTEGRATED POWER / 6. CABLE TRAY

## STEP 3. LIGHTING

Add your desired number of Linear Lamps.

**Note**  
The Linear Table Lamp has one USB-C plug.

### Linear Table Lamp

Height — 36,5 cm / 14.4"  
Width — 23,2 cm / 9.1"  
Depth — 16,5 cm / 6.5"



**Note**  
Linear Mounted Lamp must be mounted at least 5 cm / 2" from the table edge.

Please be aware that the Linear Mounted Lamp and Table Power Outlet, both designed for the Linear System Series, have a special power solution with special plugs. See more on page 4.

### Linear Mounted Lamp — 23,2 cm / 9.1"

Height — 36,5 cm / 14.4"  
Width — 23,2 cm / 9.1"  
Depth — 10,7 cm / 4.2"

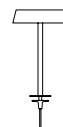

### Linear Mounted Lamp — 209,2 cm / 82.4"

Height — 70,7 cm / 27.8"  
Width — 209,2 cm / 82.4"  
Depth — 10,7 cm / 4.2"



### Linear Pendant Lamp — 87,2 cm / 34.3"

Height — 5,4 cm / 2.1"  
Width — 87,2 cm / 34.3"  
Depth — 10,7 cm / 4.2"



### Linear Pendant Lamp — 169,2 cm / 66.6"

Height — 5,4 cm / 2.1"  
Width — 169,2 cm / 66.6"  
Depth — 10,7 cm / 4.2"



## STEP 4. TABLE POWER OUTLETS

Specify your desired number of Table Power Outlets. Each Table Power Outlet has two outlets (one at each end) and one USB-A and USB-C plug to which standard plugs can be connected.

**Note**  
Linear System Table Power Outlet must be mounted at least 5 cm / 2" from the table edge and requires a power kit for functionality.

### Linear System Table Power Outlet — US

Height — 7 cm / 2.8"  
Width — 7 cm / 2.8"  
Length — 18 cm / 7.1"

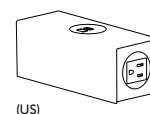

(US)

## OPTION B

1. TABLES / 2. ACCESSORIES / 3. LIGHTING / 4. TABLE POWER OUTLET / 5. INTEGRATED POWER / 6. CABLE TRAY



## STEP 5. INTEGRATED POWER FOR MOUNTED LAMPS & TABLE POWER OUTLET

If you'd like to add the Mounted Lamp(s) and/or Table Power Outlets, select the Power Kit.

If you add a End Module or a Middle Module — 240 cm / 94.5" add a Power Kit for each table added.

If you add a End Module or a Middle Module — 240 cm / 94.5", select the 250 cm / 98" Power Extension Kit.

If you add a End Module — 120 cm / 47.2", select the 200 cm / 79" Power Extension kit.

### Power Kit (1 pcs)

500 cm / 197" cable (US)  
Distribution Block

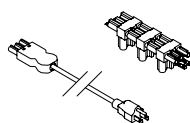

### Example 1

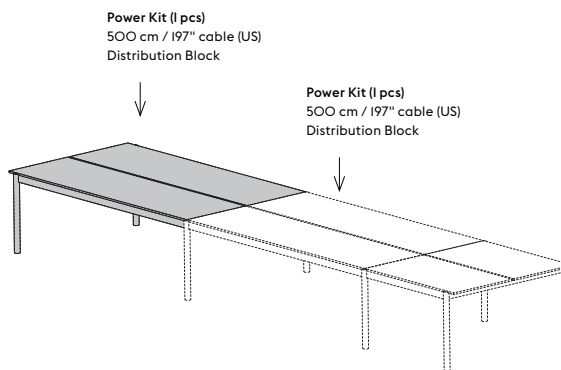

### Example 2

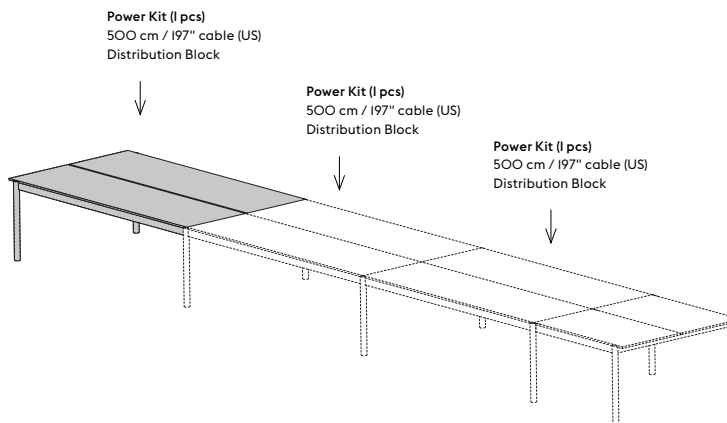

### OPTION B

1. TABLES / 2. ACCESSORIES / 3. LIGHTING / 4. TABLE POWER OUTLET / 5. INTEGRATED POWER / 6. CABLE TRAY

## LINEAR TABLE LAMP ONLY

The Linear Table Lamp can either be connected to a standard wall plug or the Table Power Outlet.

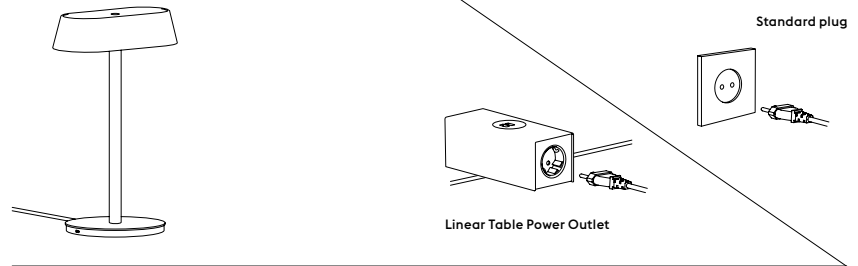

Alternatively, you can connect it to the integrated Table Power Kit by replacing the plug with a custom Wieland GST1813 plug that is included with the lamp. Kindly refer to the Linear Table Lamp manual for instructions.

Integrated Table Power Kit (Wieland GST1813 plug)

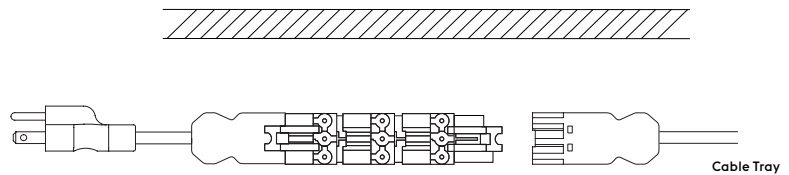

## STEP 6. CABLE TRAYS

We recommend using 1 Cable Tray for the End Module – 120 cm / 47.2" and up to 3 Cable Trays for the Linear Table, End Module – 240 cm / 94.2" and the Middle Module – 240 cm / 94.2".

### Linear System Cable Tray

Height – 3 cm / 1.2"  
Width – 22 cm / 8.7"  
Depth – 60 cm / 23.7"

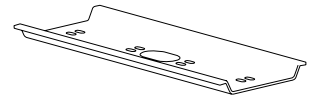

### Example:

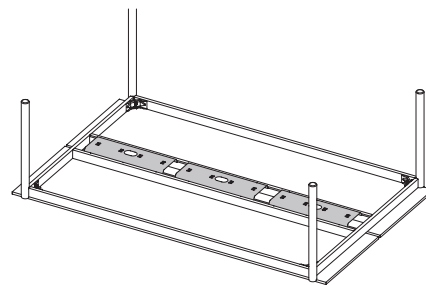

Linear System Table – 240 cm / 94.5"

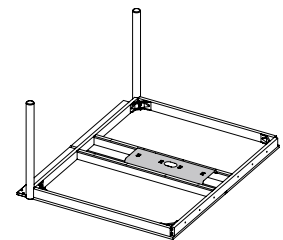

Linear System End Module – 120 cm / 47.2"

### OPTION B

1. TABLES / 2. ACCESSORIES / 3. LIGHTING / 4. TABLE POWER OUTLET / 5. INTEGRATED POWER / 6. CABLE TRAY

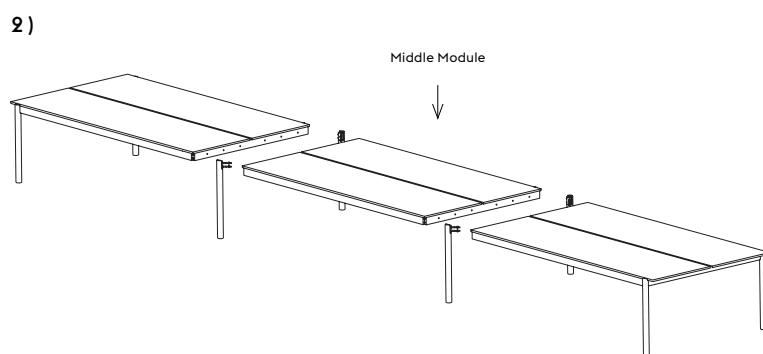
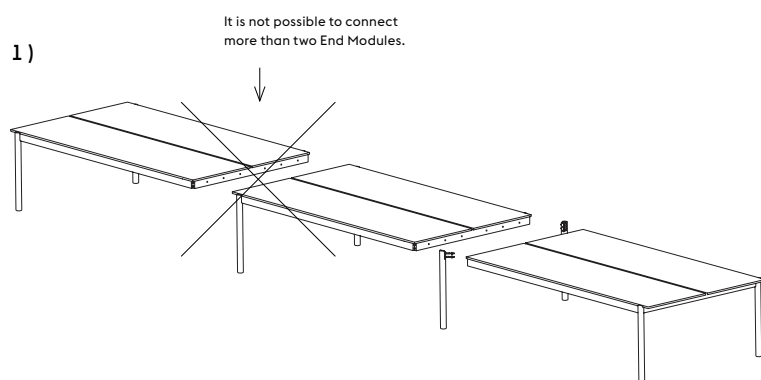

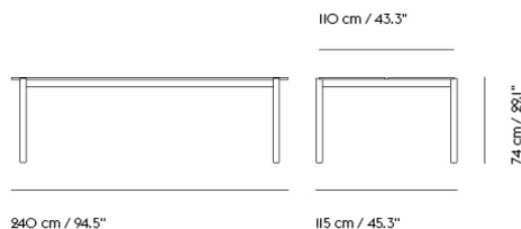
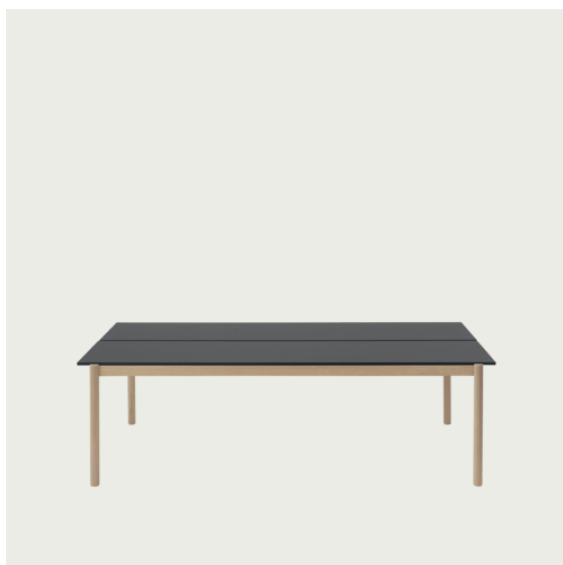

<b>Shipper Colli</b>	2
<b>Gross Weight (kg)</b>	69.057
<b>Net Weight (kg)</b>	61.8
<b>Add-ons</b>	Please visit <a href="http://planner.muuto.com/linear">planner.muuto.com/linear</a> for recommended lighting, power and accessories
<b>Warranty Period</b>	5 years

Pattern No.	Color	Contract Price	Lead Time
<b>Ready-To-Ship EU Warehouse</b>			
MLINSYT4330TM-BLCK-OAK	Black Nanolaminate/Black ABS/Oak	USD 3,726.00	-
MLINSYT4330TM-OAK-OAK	Oak Veneer/Oak	USD 3,201.00	-
MLINSYT4330TM-BLCK-BLCK	Black Nanolaminate/Black ABS/Black	USD 3,726.00	-

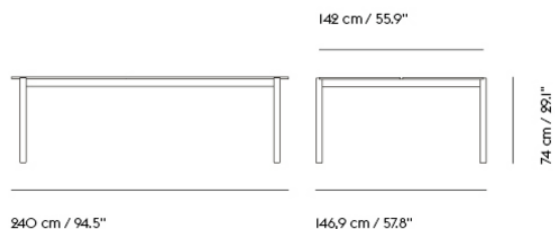
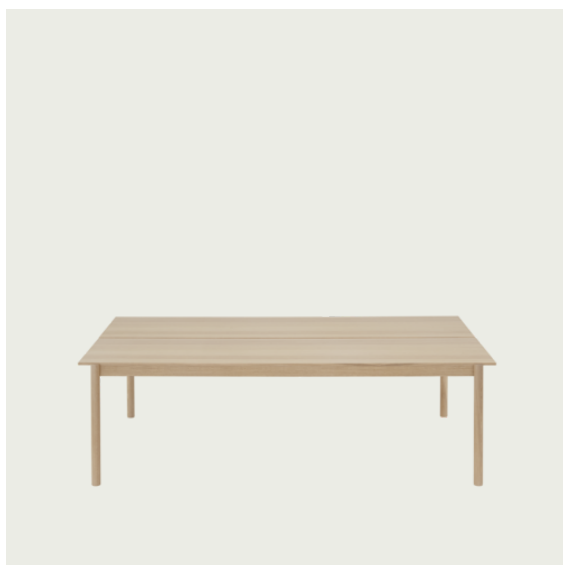

<b>Shipper Colli</b>	2
<b>Gross Weight (kg)</b>	69.057
<b>Net Weight (kg)</b>	61.8
<b>Add-ons</b>	Please visit <a href="http://planner.muuto.com/linear">planner.muuto.com/linear</a> for recommended lighting, power and accessories
<b>Warranty Period</b>	5 years

Pattern No.	Color	Contract Price	Lead Time
<b>Ready-To-Ship US Warehouse</b>			
MLINSYTTM-WHIT-OAK	White Laminate/White ABS/Oak ***	USD 3,145.00	-
MLINSYTTM-BLCK-BLCK	Black Nanolaminate/Black ABS/Black	USD 3,880.00	-
MLINSYTTM-BLCK-OAK	Black Nanolaminate/Black ABS/Oak	USD 3,880.00	-
MLINSYTTM-OAK-OAK	Oak Veneer/Oak	USD 3,355.00	-
MLINSYTTM-BASH-BLCK	Black Lacquered Ash Veneer/Black	USD 3,355.00	-

**LINEAR SYSTEM TABLE /  
CONFIGURATION I - W: 110 CM / 43.3"**



360 cm / 141.7"

110 cm / 43.3"

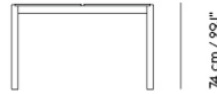

74 cm / 29.1"

115 cm / 45.3"

<b>Shipper Colli</b>	5
<b>Gross Weight (kg)</b>	101.177
<b>Net Weight (kg)</b>	90.975
<b>Add-ons</b>	Please visit <a href="http://planner.muuto.com/linear">planner.muuto.com/linear</a> for recommended lighting, power and accessories
<b>Warranty Period</b>	5 years

Pattern No.	Color	Contract Price	Lead Time
<b>Ready-To-Ship EU Warehouse</b>			
MLINSYT4330C1-BLCK-BLCK	Black Nanolaminate/Black ABS/Black	USD 5,560.00	-
MLINSYT4330C1-BLCK-OAK	Black Nanolaminate/Black ABS/Oak	USD 5,560.00	-
MLINSYT4330C1-OAK-OAK	Oak Veneer/Oak	USD 5,035.00	-

# LINEAR SYSTEM TABLE / CONFIGURATION I - W: 142 CM / 55.9"



360 cm / 141.7"

142 cm / 55.9"



74 cm / 29.1"

146.9 cm / 57.8"

<b>Shipper Colli</b>	5
<b>Gross Weight (kg)</b>	109.886
<b>Net Weight (kg)</b>	93.895
<b>Add-ons</b>	Please visit <a href="http://planner.muuto.com/linear">planner.muuto.com/linear</a> for recommended lighting, power and accessories
<b>Warranty Period</b>	5 years

Pattern No.	Color	Contract Price	Lead Time
<b>Ready-To-Ship US Warehouse</b>			
MLINSYTC1-WHIT-OAK	White Laminate/White ABS/Oak	USD 4,671.00	-
MLINSYTC1-BLCK-BLCK	Black Nanolaminate/Black ABS/Black	USD 5,875.00	-
MLINSYTC1-BLCK-OAK	Black Nanolaminate/Black ABS/Oak	USD 5,875.00	-
MLINSYTC1-OAK-OAK	Oak Veneer/Oak	USD 5,245.00	-
MLINSYTC1-BASH-BLCK	Black Lacquered Ash Veneer/Black	USD 5,245.00	-

**LINEAR SYSTEM TABLE /  
CONFIGURATION 2 - W: 110 CM / 43.3"**

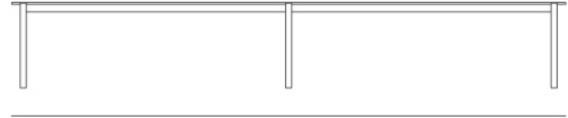

480 cm / 189"

110 cm / 43.3"



74 cm / 29.1"

115 cm / 45.3"

<b>Shipper Colli</b>	5
<b>Gross Weight (kg)</b>	129.612
<b>Net Weight (kg)</b>	119
<b>Add-ons</b>	Please visit <a href="http://planner.muuto.com/linear">planner.muuto.com/linear</a> for recommended lighting, power and accessories
<b>Warranty Period</b>	5 years

Pattern No.	Color	Contract Price	Lead Time
<b>Ready-To-Ship EU Warehouse</b>			
MLINSYT4330C2-BLCK-BLCK	Black Nanolaminate/Black ABS/Black	USD 7,240.00	-
MLINSYT4330C2-BLCK-OAK	Black Nanolaminate/Black ABS/Oak	USD 7,240.00	-
MLINSYT4330C2-OAK-OAK	Oak Veneer/Oak	USD 6,295.00	-



# LINEAR SYSTEM TABLE / CONFIGURATION 2 - W: 142 CM / 55.9"

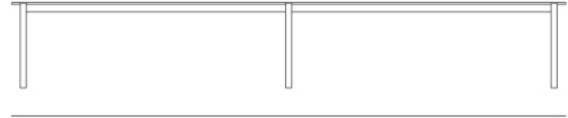
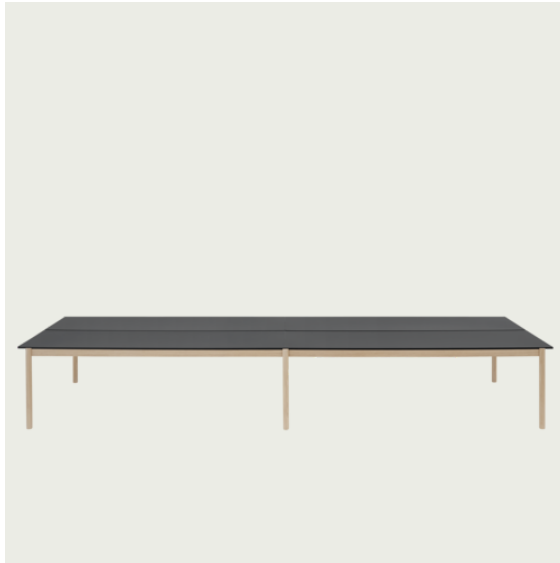

480 cm / 189"

142 cm / 55.9"



74 cm / 29.1"

146,9 cm / 57.8"

<b>Shipper Colli</b>	5
<b>Gross Weight (kg)</b>	141.512
<b>Net Weight (kg)</b>	122.82
<b>Add-ons</b>	Please visit <a href="http://planner.muuto.com/linear">planner.muuto.com/linear</a> for recommended lighting, power and accessories
<b>Warranty Period</b>	5 years

Pattern No.	Color	Contract Price	Lead Time
<b>Ready-To-Ship US Warehouse</b>			
MLINSYTC2-WHIT-OAK	White Laminate/White ABS/Oak ***	USD 5,875.00	-
MLINSYTC2-BLCK-BLCK	Black Nanolaminat/Black ABS/Black	USD 7,555.00	-
MLINSYTC2-BLCK-OAK	Black Nanolaminat/Black ABS/Oak	USD 7,555.00	-
MLINSYTC2-OAK-OAK	Oak Veneer/Oak	USD 6,561.00	-
MLINSYTC2-BASH-BLCK	Black Lacquered Ash Veneer/Black	USD 6,561.00	-

# LINEAR SYSTEM HIGH TABLE / W: 110 CM / 43.3" - H: 95 CM / 37.4"

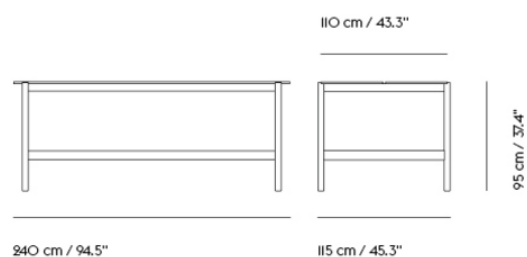

Shipper Colli	2
Gross Weight (kg)	69.057
Net Weight (kg)	61.8
Add-ons	Please visit <a href="http://planner.muuto.com/linear">planner.muuto.com/linear</a> for recommended lighting, power and accessories
Warranty Period	10 years

Pattern No.	Color	Contract Price	Lead Time
<b>Ready-To-Ship EU Warehouse</b>			
MLINSYT4337TM-BLCK-OAK	Black Nanolaminate/Black ABS/Oak	USD 5,140.00	-
MLINSYT4337TM-OAK-OAK	Oak Veneer/Oak	USD 4,615.00	-
MLINSYT4337TM-BLCK-BLCK	Black Nanolaminate/Black ABS/Black	USD 5,140.00	-

# LINEAR SYSTEM HIGH TABLE / W: 110 CM / 43.3" / 43.3" - H: 105 CM / 41.4"

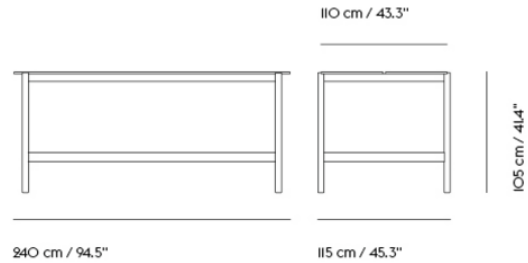

Shipper Colli	2
Gross Weight (kg)	69.057
Net Weight (kg)	61.8
Add-ons	Please visit <a href="https://planner.muuto.com/linear">planner.muuto.com/linear</a> for recommended lighting, power and accessories
Warranty Period	10 years

Pattern No.	Color	Contract Price	Lead Time
<b>Ready-To-Ship EU Warehouse</b>			
MLINSYT4341TM-BLCK-OAK	Black Nanolaminate/Black ABS/Oak	USD 5,140.00	-
MLINSYT4341TM-OAK-OAK	Oak Veneer/Oak	USD 4,615.00	-
MLINSYT4341TM-BLCK-BLCK	Black Nanolaminate/Black ABS/Black	USD 5,140.00	-

**LINEAR SYSTEM HIGH TABLE /  
CONFIGURATION I - W: 110 CM / 43.3" -  
H: 95 CM / 37.4"**



360 cm / 141.7"

110 cm / 43.3"

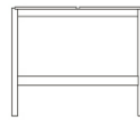

95 cm / 37.4"

115 cm / 45.3"

<b>Shipper Colli</b>	5
<b>Gross Weight (kg)</b>	101.177
<b>Net Weight (kg)</b>	90.975
<b>Add-ons</b>	Please visit <a href="http://planner.muuto.com/linear">planner.muuto.com/linear</a> for recommended lighting, power and accessories
<b>Warranty Period</b>	10 years

Pattern No.	Color	Contract Price	Lead Time
<b>Ready-To-Ship EU Warehouse</b>			
MLINSYT4337C1-BLCK-BLCK	Black Nanolaminate/Black ABS/Black	USD 7,765.00	-
MLINSYT4337C1-BLCK-OAK	Black Nanolaminate/Black ABS/Oak	USD 7,765.00	-
MLINSYT4337C1-OAK-OAK	Oak Veneer/Oak	USD 7,191.00	-

# LINEAR SYSTEM HIGH TABLE / CONFIGURATION I - W: 110 CM / 43.3" - H: 105 CM / 41.4"



360 cm / 141.7"

110 cm / 43.3"

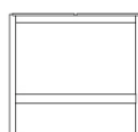

105 cm / 41.4"

115 cm / 45.3"

Shipper Colli	5
Gross Weight (kg)	101.177
Net Weight (kg)	90.975
Add-ons	Please visit <a href="http://planner.muuto.com/linear">planner.muuto.com/linear</a> for recommended lighting, power and accessories
Warranty Period	10 years

Pattern No.	Color	Contract Price	Lead Time
<b>Ready-To-Ship EU Warehouse</b>			
MLINSYT4341C1-BLCK-BLCK	Black Nanolaminate/Black ABS/Black	USD 7,765.00	-
MLINSYT4341C1-BLCK-OAK	Black Nanolaminate/Black ABS/Oak	USD 7,765.00	-
MLINSYT4341C1-OAK-OAK	Oak Veneer/Oak	USD 7,191.00	-

# LINEAR SYSTEM HIGH TABLE / CONFIGURATION 2 - W: 110 CM / 43.3" - H: 95 CM / 37.4"



480 cm / 189"

110 cm / 43.3"



95 cm / 37.4"

115 cm / 45.3"

Shipper Colli	5
Gross Weight (kg)	129.612
Net Weight (kg)	119
Add-ons	Please visit <a href="http://planner.muuto.com/linear">planner.muuto.com/linear</a> for recommended lighting, power and accessories
Warranty Period	10 years

Pattern No.	Color	Contract Price	Lead Time
<b>Ready-To-Ship EU Warehouse</b>			
MLINSYT4337C2-BLCK-BLCK	Black Nanolaminate/Black ABS/Black	USD 9,445.00	-
MLINSYT4337C2-BLCK-OAK	Black Nanolaminate/Black ABS/Oak	USD 9,445.00	-
MLINSYT4337C2-OAK-OAK	Oak Veneer/Oak	USD 8,500.00	-

**LINEAR SYSTEM HIGH TABLE /  
CONFIGURATION 2 - W: 110 CM / 43.3" -  
H: 105 CM / 41.4"**

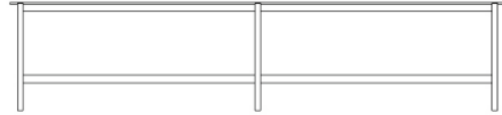

480 cm / 189"

110 cm / 43.3"

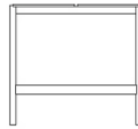

105 cm / 41.4"

115 cm / 45.3"

<b>Shipper Colli</b>	5
<b>Gross Weight (kg)</b>	129.612
<b>Net Weight (kg)</b>	119
<b>Add-ons</b>	Please visit <a href="http://planner.muuto.com/linear">planner.muuto.com/linear</a> for recommended lighting, power and accessories
<b>Warranty Period</b>	10 years

Pattern No.	Color	Contract Price	Lead Time
<b>Ready-To-Ship EU Warehouse</b>			
MLINSYT4341C2-BLCK-BLCK	Black Nanolaminate/Black ABS/Black	USD 9,445.00	-
MLINSYT4341C2-BLCK-OAK	Black Nanolaminate/Black ABS/Oak	USD 9,445.00	-
MLINSYT4341C2-OAK-OAK	Oak Veneer/Oak	USD 8,500.00	-

# LINEAR SYSTEM MIDDLE MODULE / TABLE - 110 X 240 CM / 43.3 X 94.5"

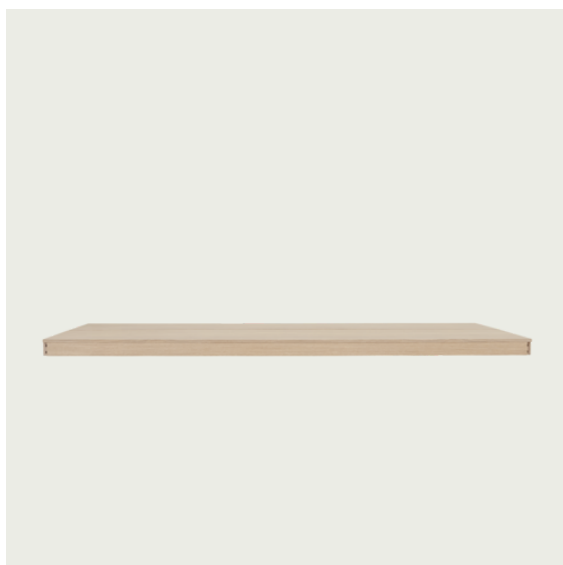

240 cm / 94.5"

Shipper Colli	2
Gross Weight (kg)	63.15
Net Weight (kg)	57.65
Add-ons	Please visit <a href="https://planner.muuto.com/linear">planner.muuto.com/linear</a> for recommended lighting, power and accessories
Warranty Period	5 years

Pattern No.	Color	Contract Price	Lead Time
<b>Ready-To-Ship EU Warehouse</b>			
MLINSYT43DNMM-BLCK-BLCK	Black Nanolaminate/Black ABS/Black	USD 3,306.00	-
MLINSYT43DNMM-BLCK-OAK	Black Nanolaminate/Black ABS/Oak	USD 3,306.00	-
MLINSYT43DNMM-OAK-OAK	Oak Veneer/Oak	USD 2,781.00	-



# LINEAR SYSTEM MIDDLE MODULE / TABLE - 142 X 240 CM / 55.9 X 94.5"



240 cm / 94.5"

Shipper Colli	2
Gross Weight (kg)	63.15
Net Weight (kg)	57.65
Add-ons	Please visit <a href="https://planner.muuto.com/linear">planner.muuto.com/linear</a> for recommended lighting, power and accessories
Warranty Period	5 years

Pattern No.	Color	Contract Price	Lead Time
<b>Ready-To-Ship US Warehouse</b>			
MLINSYTMM-WHIT-OAK	White Laminate/White ABS/Oak ***	USD 2,781.00	-
MLINSYTMM-BLCK-BLCK	Black Nanolaminate/Black ABS/Black	USD 3,516.00	-
MLINSYTMM-BLCK-OAK	Black Nanolaminate/Black ABS/Oak	USD 3,516.00	-
MLINSYTMM-OAK-OAK	Oak Veneer/Oak	USD 2,886.00	-
MLINSYTMM-BASH-BLCK	Black Lacquered Ash Veneer/Black	USD 2,886.00	-

# LINEAR SYSTEM MIDDLE MODULE / HIGH TABLE - 110 X 240 CM / 43.3 X 94.5"

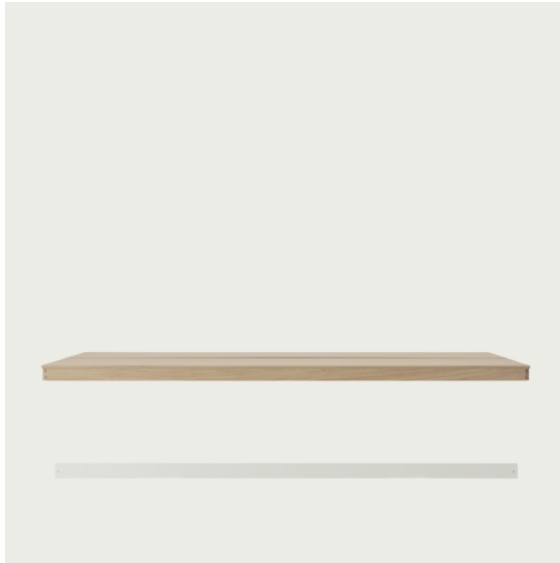

**Shipper Colli** 2  
**Gross Weight (kg)** 63.15  
**Net Weight (kg)** 57.65  
**Add-ons** Please visit [planner.muuto.com/linear](http://planner.muuto.com/linear) for recommended lighting, power and accessories  
**Warranty Period** 10 years

Pattern No.	Color	Contract Price	Lead Time
<b>Ready-To-Ship EU Warehouse</b>			
MLINSYT43HTMM-BLCK-BLCK	Black Nanolaminate/Black ABS/Black	USD 3,411.00	-
MLINSYT43HTMM-BLCK-OAK	Black Nanolaminate/Black ABS/Oak	USD 3,411.00	-
MLINSYT43HTMM-OAK-OAK	Oak Veneer/Oak	USD 2,935.00	-

# LINEAR SYSTEM END MODULE / TABLE - 142 X 120 CM / 55.9 X 47.2"

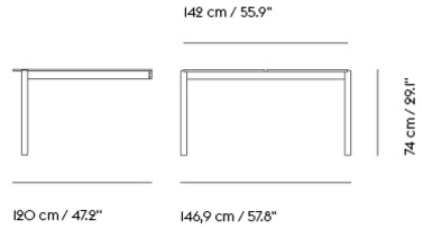
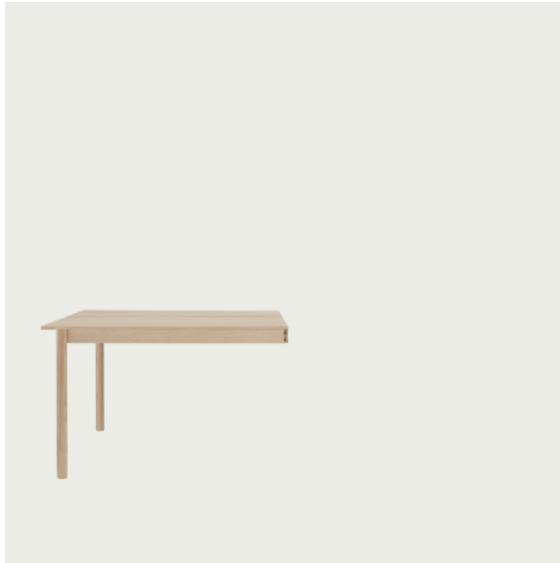

<b>Shipper Colli</b>	2
<b>Gross Weight (kg)</b>	36.371
<b>Net Weight (kg)</b>	31.475
<b>Add-ons</b>	Please visit <a href="http://planner.muuto.com/linear">planner.muuto.com/linear</a> for recommended lighting, power and accessories
<b>Warranty Period</b>	5 years

Pattern No.	Color	Contract Price	Lead Time
<b>Ready-To-Ship US Warehouse</b>			
MLINSYTEM5647-WHIT-OAK	White Laminate/White ABS/Oak ***	USD 1,836.00	-
MLINSYTEM5647-BLCK-BLCK	Black Nanolaminate/Black ABS/Black	USD 2,361.00	-
MLINSYTEM5647-BLCK-OAK	Black Nanolaminate/Black ABS/Oak	USD 2,361.00	-
MLINSYTEM5647-OAK-OAK	Oak Veneer/Oak	USD 1,836.00	-
MLINSYTEM5647-BASH-BLCK	Black Lacquered Ash Veneer/Black	USD 1,836.00	-

# LINEAR SYSTEM END MODULE / TABLE - 142 X 240 CM / 55.9 X 94.5"

289

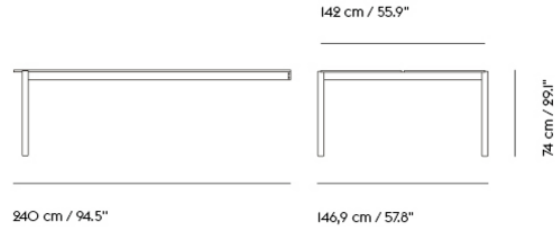

Shipper Colli	2
Gross Weight (kg)	64.806
Net Weight (kg)	59.5
Add-ons	Please visit <a href="http://planner.muuto.com/linear">planner.muuto.com/linear</a> for recommended lighting, power and accessories
Warranty Period	5 years

Pattern No.	Color	Contract Price	Lead Time
<b>Ready-To-Ship US Warehouse</b>			
MLINSYTEM5695-WHIT-OAK	White Laminate/White ABS/Oak ***	USD 3,355.00	-
MLINSYTEM5695-BLCK-BLCK	Black Nanolaminate/Black ABS/Black	USD 3,831.00	-
MLINSYTEM5695-BLCK-OAK	Black Nanolaminate/Black ABS/Oak	USD 3,831.00	-
MLINSYTEM5695-OAK-OAK	Oak Veneer/Oak	USD 3,355.00	-
MLINSYTEM5695-BASH-BLCK	Black Lacquered Ash Veneer/Black	USD 3,355.00	-

# LINEAR SYSTEM END MODULE / TABLE - 110 X 120 H: 74 CM / 43.3 X 47.2 H: 29.1"

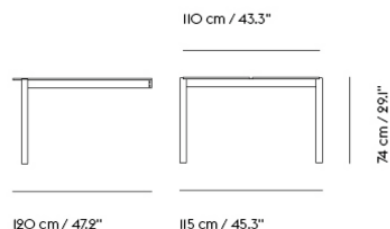
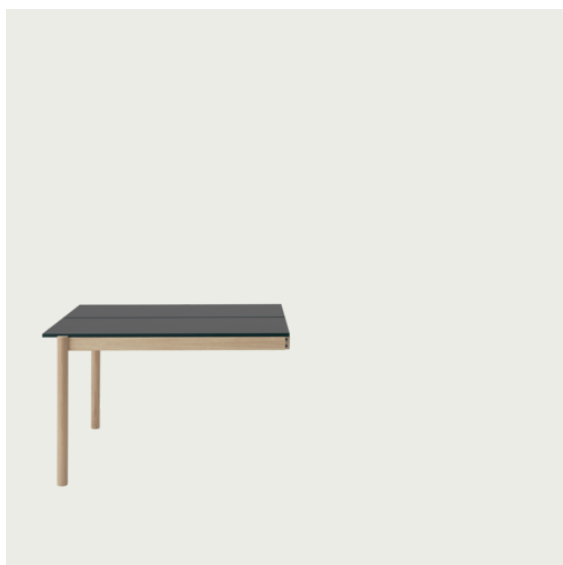

Shipper Colli	2
Gross Weight (kg)	36.371
Net Weight (kg)	31.475
Add-ons	Please visit <a href="https://planner.muuto.com/linear">planner.muuto.com/linear</a> for recommended lighting, power and accessories
Warranty Period	5 years

Pattern No.	Color	Contract Price	Lead Time
<b>Ready-To-Ship EU Warehouse</b>			
MLINSYT4330EM5647-BLCK-BLCK	Black Nanolaminate/Black ABS/Black	USD 2,305.00	-
MLINSYT4330EM5647-BLCK-OAK	Black Nanolaminate/Black ABS/Oak	USD 2,305.00	-
MLINSYT4330EM5647-OAK-OAK	Oak Veneer/Oak	USD 1,731.00	-

**LINEAR SYSTEM END MODULE / TABLE -  
110 X 240 H: 74 CM / 43.3 X 94.5 H: 29.1"**

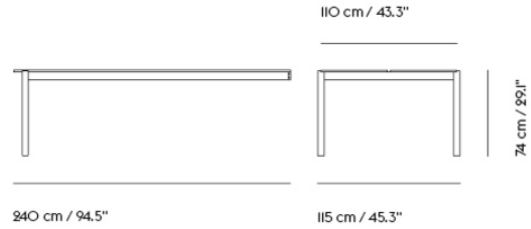

- Shipper Colli** 2
- Gross Weight (kg)** 64.806
- Net Weight (kg)** 59.5
- Add-ons** Please visit [planner.muuto.com/linear](http://planner.muuto.com/linear) for recommended lighting, power and accessories
- Warranty Period** 5 years

Pattern No.	Color	Contract Price	Lead Time
<b>Ready-To-Ship EU Warehouse</b>			
MLINSYT4330EM5695-BLCK-BLCK	Black Nanolaminate/Black ABS/Black	USD 3,621.00	-
MLINSYT4330EM5695-BLCK-OAK	Black Nanolaminate/Black ABS/Oak	USD 3,621.00	-
MLINSYT4330EM5695-OAK-OAK	Oak Veneer/Oak	USD 3,201.00	-

# LINEAR SYSTEM END MODULE / HIGH TABLE - 110 X 120 H: 95 CM / 43.3 X 47.2 H: 37.4"

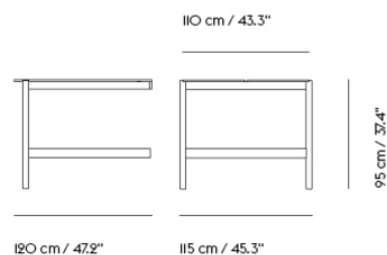

Shipper Colli	2
Gross Weight (kg)	36.371
Net Weight (kg)	31.475
Add-ons	Please visit <a href="https://planner.muuto.com/linear">planner.muuto.com/linear</a> for recommended lighting, power and accessories
Warranty Period	10 years

Pattern No.	Color	Contract Price	Lead Time
<b>Ready-To-Ship EU Warehouse</b>			
MLINSYT4337EM5647-BLCK-BLCK	Black Nanolaminate/Black ABS/Black	USD 3,040.00	-
MLINSYT4337EM5647-BLCK-OAK	Black Nanolaminate/Black ABS/Oak	USD 3,040.00	-
MLINSYT4337EM5647-OAK-OAK	Oak Veneer/Oak	USD 2,410.00	-

**LINEAR SYSTEM END MODULE / HIGH TABLE - 110 X 240 H: 95 CM / 43.3 X 94.5 H: 37.4"**

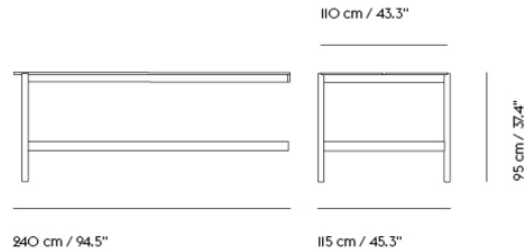

<b>Shipper Colli</b>	2
<b>Gross Weight (kg)</b>	64.806
<b>Net Weight (kg)</b>	59.5
<b>Add-ons</b>	Please visit <a href="http://planner.muuto.com/linear">planner.muuto.com/linear</a> for recommended lighting, power and accessories
<b>Warranty Period</b>	10 years

Pattern No.	Color	Contract Price	Lead Time
<b>Ready-To-Ship EU Warehouse</b>			
MLINSYT4337EM5695-BLCK-BLCK	Black Nanolaminate/Black ABS/Black	USD 4,251.00	-
MLINSYT4337EM5695-BLCK-OAK	Black Nanolaminate/Black ABS/Oak	USD 4,251.00	-
MLINSYT4337EM5695-OAK-OAK	Oak Veneer/Oak	USD 3,880.00	-



# LINEAR SYSTEM END MODULE / HIGH TABLE - 110 X 120 H: 105 CM / 43.3 X 47.2 H: 41.4"

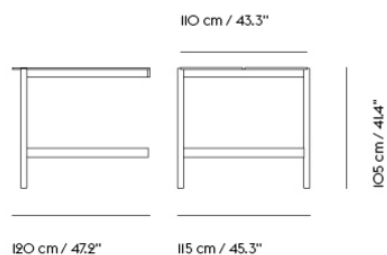

Shipper Colli	2
Gross Weight (kg)	36.371
Net Weight (kg)	31.475
Add-ons	Please visit <a href="http://planner.muuto.com/linear">planner.muuto.com/linear</a> for recommended lighting, power and accessories
Warranty Period	10 years

Pattern No.	Color	Contract Price	Lead Time
<b>Ready-To-Ship EU Warehouse</b>			
MLINSYT4341EM5647-BLCK-BLCK	Black Nanolaminate/Black ABS/Black	USD 3,040.00	-
MLINSYT4341EM5647-BLCK-OAK	Black Nanolaminate/Black ABS/Oak	USD 3,040.00	-
MLINSYT4341EM5647-OAK-OAK	Oak Veneer/Oak	USD 2,410.00	-

**LINEAR SYSTEM END MODULE / HIGH  
TABLE - 110 X 240 H: 105 CM / 43.3 X 94.5  
H: 41.4"**

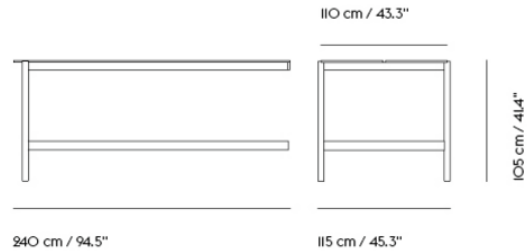
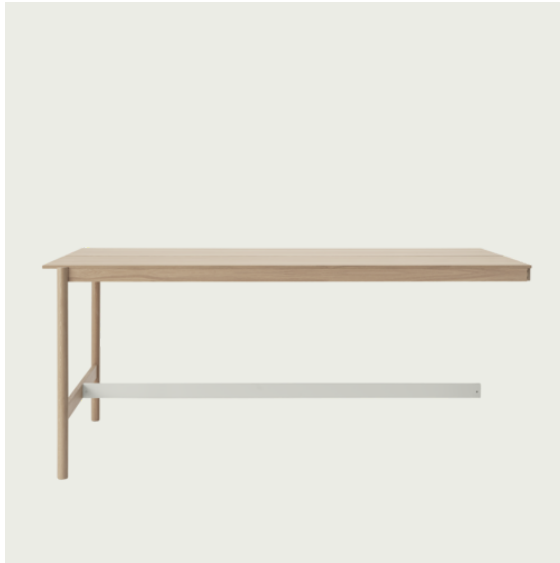

<b>Shipper Colli</b>	2
<b>Gross Weight (kg)</b>	64.806
<b>Net Weight (kg)</b>	59.5
<b>Add-ons</b>	Please visit <a href="http://planner.muuto.com/linear">planner.muuto.com/linear</a> for recommended lighting, power and accessories
<b>Warranty Period</b>	10 years

Pattern No.	Color	Contract Price	Lead Time
<b>Ready-To-Ship EU Warehouse</b>			
MLINSYT4341EM5695-BLCK-BLCK	Black Nanolaminate/Black ABS/Black	USD 4,251.00	-
MLINSYT4341EM5695-BLCK-OAK	Black Nanolaminate/Black ABS/Oak	USD 4,251.00	-
MLINSYT4341EM5695-OAK-OAK	Oak Veneer/Oak	USD 3,880.00	-

# LINEAR SYSTEM CONNECTING LEGS / TABLE - H: 74 CM



Shipper Colli	1
Gross Weight (kg)	3.6
Net Weight (kg)	3
Add-ons	Please visit <a href="https://planner.muuto.com/linear">planner.muuto.com/linear</a> for recommended lighting, power and accessories
Warranty Period	5 years

Pattern No.	Color	Contract Price	Lead Time
<b>Ready-To-Ship US Warehouse</b>			
MLINSYTCL-BLCK	Black	USD 310.00	-
MLINSYTCL-OAK	Oak	USD 310.00	-
<b>Ready-To-Ship EU Warehouse</b>			
MLINSYT4330CL-BLCK-BLCK	Black - H: 74 cm / 29.1"	USD 257.00	-
MLINSYT4330CL-OAK-OAK	Oak - H: 74 cm / 29.1"	USD 257.00	-

# LINEAR SYSTEM CONNECTING LEGS / HIGH TABLE - H: 95 CM



Shipper Colli	1
Gross Weight (kg)	7.1
Net Weight (kg)	6.2
Add-ons	Please visit <a href="https://planner.muuto.com/linear">planner.muuto.com/linear</a> for recommended lighting, power and accessories
Warranty Period	10 years

Pattern No.	Color	Contract Price	Lead Time
<b>Ready-To-Ship EU Warehouse</b>			
MLINSYT4337CL-OAK-OAK	Oak - H: 95 cm / 37.4"	USD 394.00	-
MLINSYT4337CL-BLCK-BLCK	Black - H: 95 cm / 37.4"	USD 404.00	-

# LINEAR SYSTEM CONNECTING LEGS / HIGH TABLE - H: 105 CM

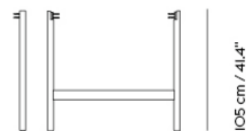

Shipper Colli	1
Gross Weight (kg)	5.6
Net Weight (kg)	4.7
Add-ons	Please visit <a href="https://planner.muuto.com/linear">planner.muuto.com/linear</a> for recommended lighting, power and accessories
Warranty Period	10 years

Pattern No.	Color	Contract Price	Lead Time
<b>Ready-To-Ship EU Warehouse</b>			
MLINSYT4341CL-OAK-OAK	Oak - H: 105 cm / H: 41.3"	USD 404.00	-
MLINSYT4341CL-BLCK-BLCK	Black - H: 105 cm / H: 41.3"	USD 415.00	-

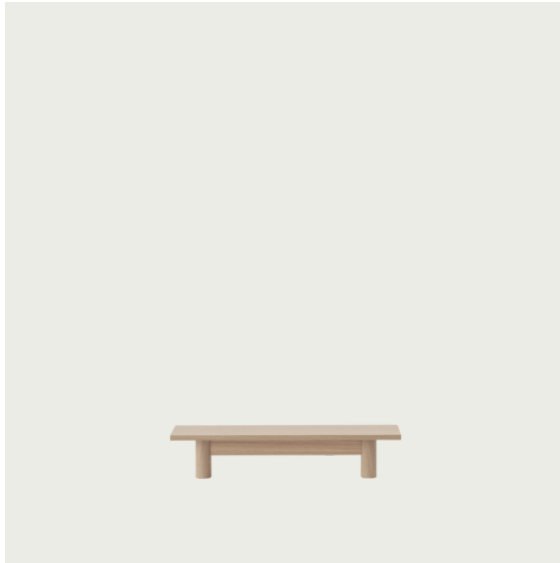

75 cm / 29.5"

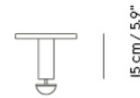

15 cm / 5.9"

21 cm / 8.3"

Shipper Colli	1
Gross Weight (kg)	4.75
Net Weight (kg)	3.5
Add-ons	Please visit <a href="http://planner.muuto.com/linear">planner.muuto.com/linear</a> for recommended lighting, power and accessories
Warranty Period	5 years

Pattern No.	Color	Contract Price	Lead Time
<b>Ready-To-Ship EU Warehouse</b>			
MLINSYTTR30-BLCK	Black	USD 257.00	-
MLINSYTTR30-OAK	Oak	USD 257.00	-

# LINEAR SYSTEM TRAY / 170 CM / 66.9"

300



170 cm / 66.9"



21 cm / 8.3"

Shipper Colli	1
Gross Weight (kg)	11.805
Net Weight (kg)	6.7
Add-ons	Please visit <a href="https://planner.muuto.com/linear">planner.muuto.com/linear</a> for recommended lighting, power and accessories
Warranty Period	5 years

Pattern No.	Color	Contract Price	Lead Time
<b>Ready-To-Ship US Warehouse</b>			
MLINSYTTR67-BLCK	Black	USD 450.00	-
MLINSYTTR67-OAK	Oak ***	USD 450.00	-

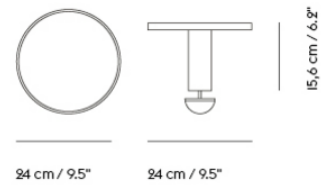

Shipper Colli	1
Gross Weight (kg)	2.805
Net Weight (kg)	0.85
Add-ons	Please visit <a href="http://planner.muuto.com/linear">planner.muuto.com/linear</a> for recommended lighting, power and accessories
Warranty Period	5 years

Pattern No.	Color	Contract Price	Lead Time
<b>Ready-To-Ship US Warehouse</b>			
MLINSYTT09-BLCK	Black	USD 226.00	-
MLINSYTT09-OAK	Oak	USD 226.00	-



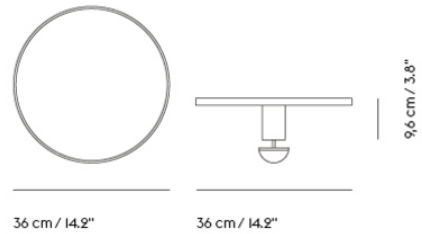

Shipper Colli	1
Gross Weight (kg)	3.603
Net Weight (kg)	1.4
Add-ons	Please visit <a href="http://planner.muuto.com/linear">planner.muuto.com/linear</a> for recommended lighting, power and accessories
Warranty Period	5 years

Pattern No.	Color	Contract Price	Lead Time
<b>Ready-To-Ship US Warehouse</b>			
MLINSYTT014-BLCK	Black	USD 236.00	-
MLINSYTT014-OAK	Oak	USD 236.00	-

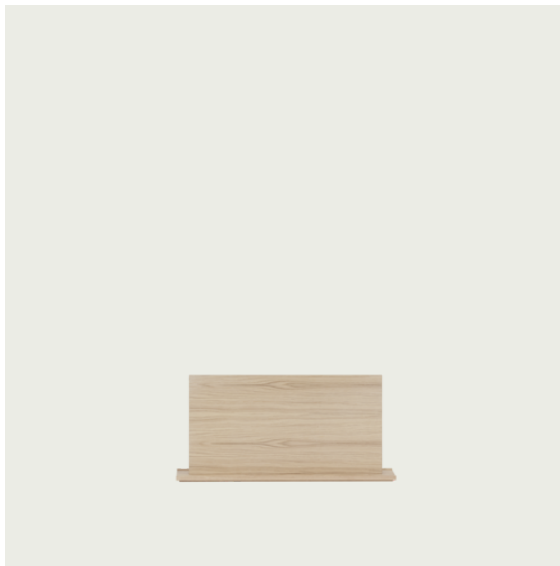

75 cm / 29.5"

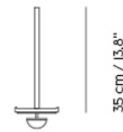

35 cm / 13.8"

15 cm / 5.9"

Shipper Colli	1
Gross Weight (kg)	6.35
Net Weight (kg)	3.9
Add-ons	Please visit <a href="http://planner.muuto.com/linear">planner.muuto.com/linear</a> for recommended lighting, power and accessories
Warranty Period	5 years

Pattern No.	Color	Contract Price	Lead Time
<b>Ready-To-Ship US Warehouse</b>			
MLINSYSW29-BLCK	Black	USD 383.00	-
MLINSYSW29-OAK	Oak	USD 383.00	-

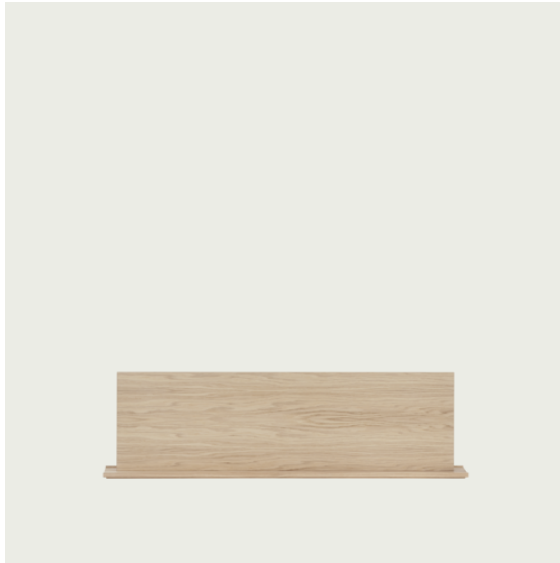

125 cm / 49.2"

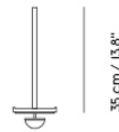

15 cm / 5.9"

Shipper Colli	1
Gross Weight (kg)	9.6
Net Weight (kg)	6.6
Add-ons	Please visit <a href="http://planner.muuto.com/linear">planner.muuto.com/linear</a> for recommended lighting, power and accessories
Warranty Period	5 years

Pattern No.	Color	Contract Price	Lead Time
<b>Ready-To-Ship US Warehouse</b>			
MLINSYSW49-BLCK	Black	USD 520.00	-
MLINSYSW49-OAK	Oak	USD 520.00	-



178 cm / 70.1"

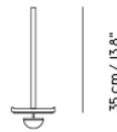

15 cm / 5.9"

Shipper Colli	1
Gross Weight (kg)	13.849
Net Weight (kg)	9.25
Add-ons	Please visit <a href="http://planner.muuto.com/linear">planner.muuto.com/linear</a> for recommended lighting, power and accessories
Warranty Period	5 years

Pattern No.	Color	Contract Price	Lead Time
<b>Ready-To-Ship US Warehouse</b>			
MLINSYSW70-BLCK	Black	USD 681.00	-
MLINSYSW70-OAK	Oak	USD 681.00	-



- Shipper Colli** | 1
- Gross Weight (kg)** | 1.832
- Net Weight (kg)** | 1.3
- Bulb included** | Yes. Integrated, dimmable, non-replaceable LED module.
- Add-ons** | Please visit [planner.muuto.com/linear](http://planner.muuto.com/linear) for recommended lighting, power and accessories
- Warranty Period** | 5 years

Pattern No.	Color	Contract Price	Lead Time
<b>Ready-To-Ship US Warehouse</b>			
MLINLTBLP-BLCK	Black	USD 492.00	-
MLINLTBLP-GREY	Grey	USD 492.00	-

# LINEAR MOUNTED LAMP / 209,2 CM / 82.4"

307

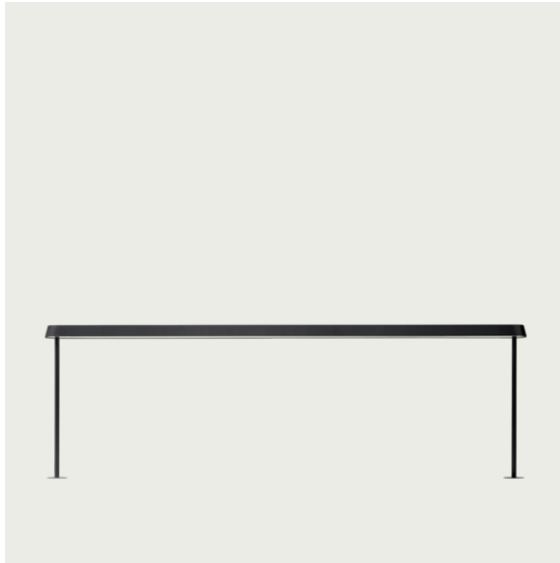

Shipper Colli	1
Gross Weight (kg)	7.8
Net Weight (kg)	4.8
Please note	Only usable with Linear System Power Kit. The connector pins in this product contains lead, CAS no. 7439-92-1.
Bulb included	Yes. Integrated LED.
Warranty Period	5 years

Pattern No.	Color	Contract Price	Lead Time
<b>Ready-To-Ship US Warehouse</b>			
MLINSYML82-BLCK	Black	USD 2,046.00	-
MLINSYML82-GREY	Grey	USD 2,046.00	-

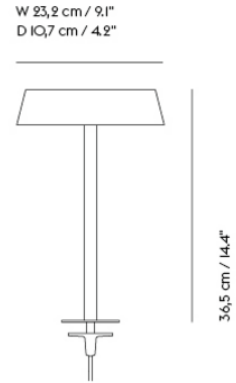

- Shipper Colli 1
- Gross Weight (kg) 1.5
- Net Weight (kg) 1
- Please note Only usable with Linear System Power Kit. The connector pins in this product contains lead, CAS no. 7439-92-1.
- Bulb included Yes. Integrated LED.
- Warranty Period 5 years

Pattern No.	Color	Contract Price	Lead Time
<b>Ready-To-Ship US Warehouse</b>			
MLINSYML9-BLCK	Black	USD 614.00	-
MLINSYML9-GREY	Grey	USD 614.00	-

# LINEAR PENDANT LAMP / 169,2 CM / 66.6"

309

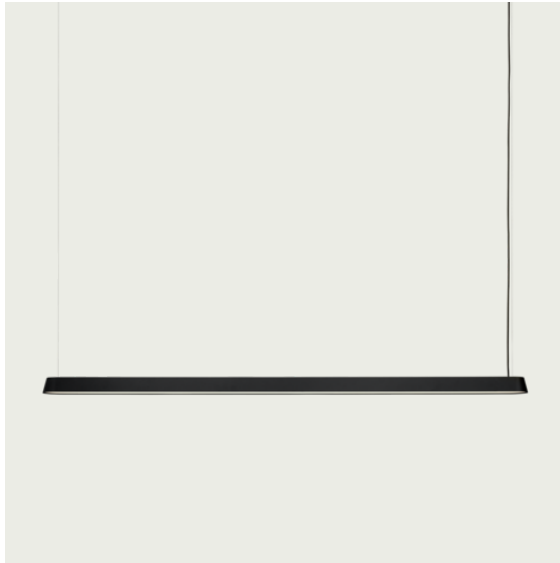

W 169,2 cm / 66.6"  
D 10,7 cm / 4.2"

Shipper Colli	1
Gross Weight (kg)	4.9
Net Weight (kg)	3.3
Bulb included	Yes. Integrated LED.
Warranty Period	5 years

Pattern No.	Color	Contract Price	Lead Time
<b>Ready-To-Ship US Warehouse</b>			
MLINLPDLP66-BLCK	Black	USD 1,465.00	-
MLINLPDLP66-GREY	Grey	USD 1,465.00	-



# LINEAR PENDANT LAMP / 87,2 CM / 34.3"

310



W 87,2 cm / 34.3"  
D 10,7 cm / 4.2"

Shipper Colli	1
Gross Weight (kg)	3.2
Net Weight (kg)	2.2
Bulb included	Yes. Integrated LED.
Warranty Period	5 years

Pattern No.	Color	Contract Price	Lead Time
<b>Ready-To-Ship US Warehouse</b>			
MLINLPDLP34-BLCK	Black	USD 1,101.00	-
MLINLPDLP34-GREY	Grey	USD 1,101.00	-

# LINEAR SYSTEM POWER CONFIGURATION



**Gross Weight (kg)** 0.7  
**Add-ons** Please visit [planner.muuto.com/linear](http://planner.muuto.com/linear) for recommended lighting, power and accessories  
**Please note** The connector pins in this product contains lead, CAS no. 7439-92-1  
**Warranty Period** 5 years

Pattern No.	Color	Contract Price	Lead Time
<b>Ready-To-Ship US Warehouse</b>			
MLINSYPK	Linear System Power Configuration 1	USD 278.00	-
MLINSYPC2	Black - Configuration 2	USD 541.00	-
MLINSYPC3	Black - Configuration 3	USD 807.00	-

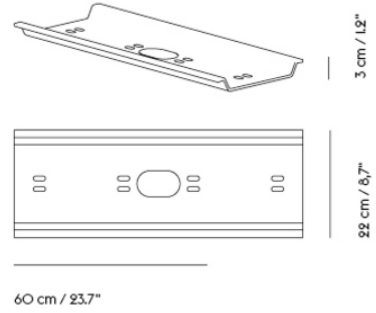

<b>Shipper Colli</b>	1
<b>Gross Weight (kg)</b>	0.212
<b>Net Weight (kg)</b>	0.181
<b>Add-ons</b>	Please visit <a href="http://planner.muuto.com/linear">planner.muuto.com/linear</a> for recommended lighting, power and accessories
<b>Warranty Period</b>	5 years

Pattern No.	Color	Contract Price	Lead Time
<b>Ready-To-Ship US Warehouse</b>			
MLINSYCT	Dark Grey	USD 135.00	-

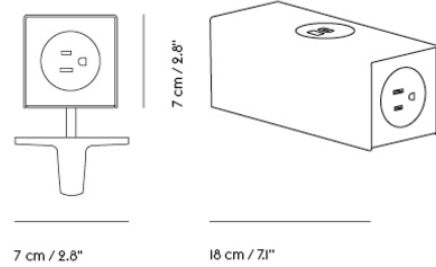

Shipper Colli	1
Gross Weight (kg)	1.5
Net Weight (kg)	1.4
Add-ons	Please visit <a href="http://planner.muuto.com/linear">planner.muuto.com/linear</a> for recommended lighting, power and accessories
Warranty period	5 years

Pattern No.	Color	Contract Price	Lead Time
<b>Ready-To-Ship US Warehouse</b>			
MLINSYPO-BLCK	Black	USD 667.00	-
MLINSYPO-GREY	Grey	USD 667.00	-

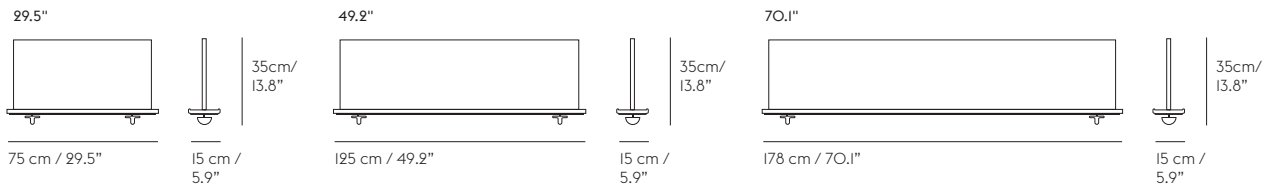

### All Variants

Contract Price

All Variants	Pattern No.	Wood Screen	Upholstery Grades			
			A	B	C	E
29.5"	M-LINSYS-W-29	383				
	M-LINSYS-U-29		509	562	614	660
49.2"	M-LINSYS-W-49	520				
	M-LINSYS-U-49		667	734	828	898
70.1"	M-LINSYS-W-70	681				
	M-LINSYS-U-70		933	1,028	1,150	1,206

### HOW TO CONFIGURE

Specify:

- Step 1: Choose variant
- Step 2: Choose base color
- Step 3: Choose textile
- Step 4: Choose textile color

### ORDER CODE EXAMPLE:

Linear System Screen 49.2" Remix 133

Size	Linear System Screen 49.2"	M-LINSYS-U-49
Textile	Remix M156	
Textile Color	133	133
Final Pattern No:	MLINSYSU49M156133	

### Upholstery Options

A	B	C	E
Ocean (M161)*	Canvas (M153)	Hallingdal (M146)	Acca (M12660)
Remix (M156)	Clara (M154)		Beck (M6376)
Wooly (M159)	Fiord (M155)		Divina (M150)
	Grain (M12659)		Divina MD (M147)
	Manner (M12665)		Divina Melange (M135)
	Re-Wool (M4586)		Ecriture (M01767)
	Sabi (M8404)		Hearth (M12664)
	Steelcut (M149)		Twill Weave (M142)
	Steelcut Trio (M139)		Vidar (M158)

\*Notes:  
Ocean - Color 3, 21, 32, 50, 52, 80 & 601

# LINEAR WOOD SERIES

FOR MORE INFORMATION,  
EXPLORE BELOW

- ↗ [Product Fact Sheet](#)
- ↗ [Images](#)
- ↗ [Architect Files](#)
- ↗ [Assembly Instructions](#)
- ↗ [Product Declaration](#)

**LINEAR WOOD TABLE / 140 X 85 CM / 55.1 X 31.5"**

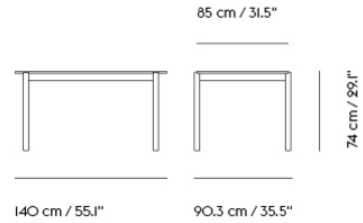

**Shipper Colli** 1  
**Gross Weight (kg)** 25.5  
**Net Weight (kg)** 18.494  
**Warranty Period** 5 years

Pattern No.	Color	Contract Price	Lead Time
<b>Ready-To-Ship US Warehouse</b>			
MLINWT5532	Oak Veneer/Oak	USD 1,675.00	-

**LINEAR WOOD TABLE / 200 X 90 CM / 78.7 X 35.4"**

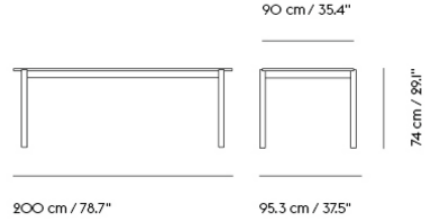

Shipper Colli 1  
 Gross Weight (kg) 36.6  
 Net Weight (kg) 28.664  
 Warranty Period 5 years

Pattern No.	Color	Contract Price	Lead Time
<b>Ready-To-Ship US Warehouse</b>			
MLINWT7933	Oak Veneer/Oak	USD 2,361.00	-



**LINEAR WOOD TABLE / 260 X 90 CM / 102.4 X 35.4"**

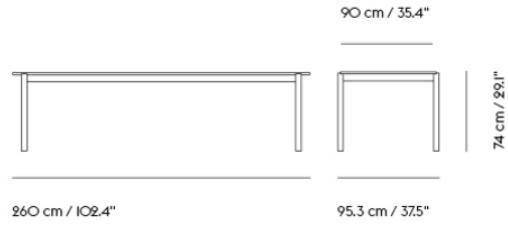

**Shipper Colli** 1  
**Gross Weight (kg)** 43.6  
**Net Weight (kg)** 34.714  
**Warranty Period** 5 years

Pattern No.	Color	Contract Price	Lead Time
<b>Ready-To-Ship US Warehouse</b>			
MLINWT10336	Oak Veneer/Oak	USD 2,571.00	-

# LINEAR WOOD BENCH / 110 X 34 CM / 43.3 X 13.4"

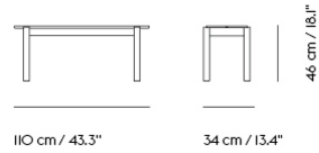

Shipper Colli 1  
Gross Weight (kg) 12  
Net Weight (kg) 7.034  
Warranty Period 10 years

Pattern No.	Color	Contract Price	Lead Time
<b>Ready-To-Ship US Warehouse</b>			
MLINWB43	Oak	USD 902.00	-

# LINEAR WOOD BENCH / 170 X 34 CM / 67 X 13.4"

320



170 cm / 66.9"



34 cm / 13.4"

46 cm / 18.1"

Shipper Colli |  
Gross Weight (kg) | 18.4  
Net Weight (kg) | 12.894  
Warranty Period | 10 years

Pattern No.	Color	Contract Price	Lead Time
<b>Ready-To-Ship US Warehouse</b>			
MLINWB67	Oak	USD 1,150.00	-

# LOFT CHAIR SERIES

FOR MORE INFORMATION,  
EXPLORE BELOW

- ↗ [Product Fact Sheet](#)
- ↗ [Images](#)
- ↗ [Architect Files](#)
- ↗ [Product Declaration](#)
- ↗ [Product Configurator](#)

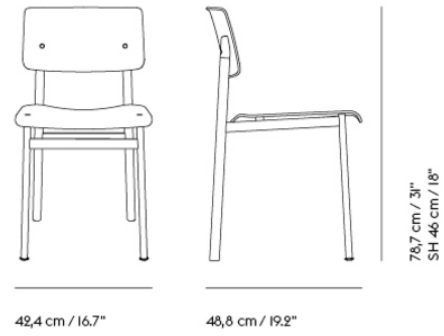

Shipper Colli	1
Gross Weight (kg)	15
Net Weight (kg)	6.6
Base color options	Black, Deep Red, Dusty Green or Grey
Warranty Period	10 years

Pattern No.	Color	Contract Price	Lead Time
<b>Ready-To-Ship US Warehouse</b>			
MLFTCW-BLCK-BLCK	Black/Black	USD 530.00	-
MLFTCW-BLCK-OAK	Oak/Black	USD 530.00	-
MLFTCW-DPRD-OAK	Oak/Deep Red	USD 530.00	-
MLFTCW-DGRN-OAK	Oak/Dusty Green	USD 530.00	-
MLFTCW-GREY-OAK	Oak/Grey	USD 530.00	-
MLFTCW-WHIT-OAK	Oak/White ***	USD 530.00	-
MLFTCW-BLCK-STDB	Stained Dark Brown/Black ***	USD 530.00	-
<b>Extras</b>			
MGLDLFSPB4	Plastic and felt glides for Loft Series (4 pcs per pack) - Black	USD 21.00	-
MLEAKIT	Leather care set for Refine Leather	USD 27.00	-

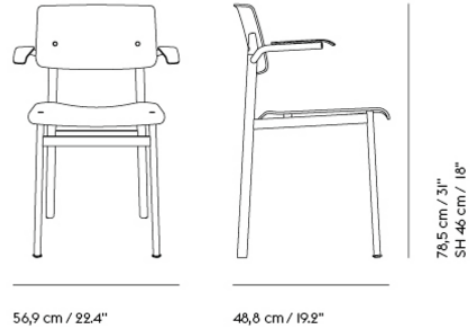

Shipper Colli 1  
 Gross Weight (kg) 17  
 Net Weight (kg) 7  
 Warranty Period 10 Years

Pattern No.	Color	Contract Price	Lead Time
<b>Ready-To-Ship US Warehouse</b>			
MLFTCAW-BLCK-BLCK	Black/Black	USD 688.00	-
MLFTCAW-BLCK-OAK	Oak/Black	USD 688.00	-
MLFTCAW-DPRD-OAK	Oak/Deep Red	USD 688.00	-
MLFTCAW-DGRN-OAK	Oak/Dusty Green	USD 688.00	-
MLFTCAW-GREY-OAK	Oak/Grey	USD 688.00	-
MLFTCAW-BLCK-STDB	Stained Dark Brown/Black	USD 688.00	-
<b>Extras</b>			
MGLDLFSPB4	Plastic and felt glides for Loft Series (4 pcs per pack) - Black	USD 21.00	-

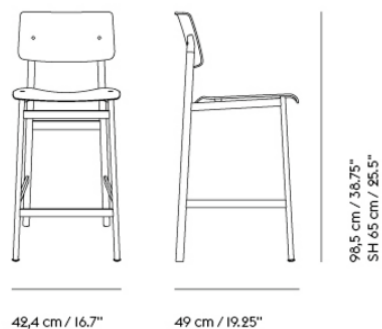

Shipper Colli	1
Gross Weight (kg)	11.55
Net Weight (kg)	8
Base color options	Black, Deep Red, Dusty Green or Grey
Warranty Period	10 years

Pattern No.	Color	Contract Price	Lead Time
<b>Ready-To-Ship US Warehouse</b>			
MLFTSTCW-BLCK-BLCK	Black/Black	USD 688.00	-
MLFTSTCW-BLCK-OAK	Oak/Black	USD 688.00	-
MLFTSTCW-DPRD-OAK	Oak/Deep Red	USD 688.00	-
MLFTSTCW-DGRN-OAK	Oak/Dusty Green	USD 688.00	-
MLFTSTCW-GREY-OAK	Oak/Grey	USD 688.00	-
<b>Extras</b>			
MGLDLFSPB4	Plastic and felt glides for Loft Series (4 pcs per pack) - Black	USD 21.00	-
MLEAKIT	Leather care set for Refine Leather	USD 27.00	-

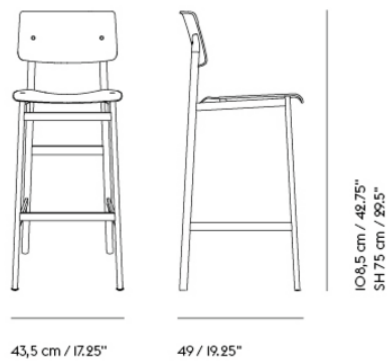
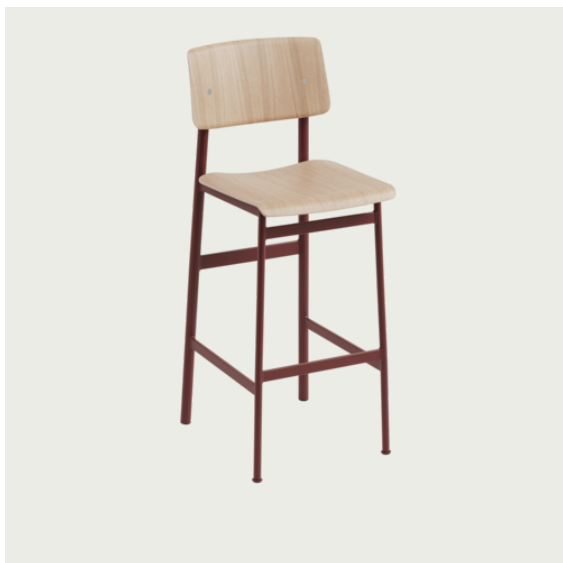

Shipper Colli	1
Gross Weight (kg)	12.05
Net Weight (kg)	8.5
Base color options	Black, Deep Red, Dusty Green or Grey
Warranty Period	10 years

Pattern No.	Color	Contract Price	Lead Time
-------------	-------	----------------	-----------

**Ready-To-Ship US Warehouse**

MLFTSTBW-BLCK-BLCK	Black/Black	USD 688.00	-
MLFTSTBW-BLCK-OAK	Oak/Black	USD 688.00	-
MLFTSTBW-DPRD-OAK	Oak/Deep Red	USD 688.00	-
MLFTSTBW-DGRN-OAK	Oak/Dusty Green	USD 688.00	-
MLFTSTBW-GREY-OAK	Oak/Grey	USD 688.00	-

**Extras**

MGLDLFSPB4	Plastic and felt glides for Loft Series (4 pcs per pack) - Black	USD 21.00	-
MLEAKIT	Leather care set for Refine Leather	USD 27.00	-



# LOFT CHAIR & STOOL



## All Upholstery Variants

	Description	Pattern No.	Upholstery Grades								
			COM		CIL			COL			
			A	B	C	E	R	T	U	V	W
Loft Chair	Upholstered Seat	M-LFTC-U	734	776	824	845	866	919	954	1,101	1,206
Loft Counter Stool	Upholstered Seat	M-LFTST-C-U	902	944	1,013	1,028	1,049	1,150	1,150	1,206	1,206
Loft Bar Stool	Upholstered Seat	M-LFTST-B-U	902	944	1,013	1,028	1,049	1,150	1,150	1,206	1,206

### HOW TO CONFIGURE

### ORDER CODE EXAMPLE: Loft w/upholstered Seat

#### Loft Chair

Oak/Black Hallingdal 810

- Specify:  
 Step 1) Choose variant  
 Step 2) Choose Base color  
 Step 3) Choose Back/seat color  
 Step 4) Choose Upholstery  
 Step 5) Choose Upholstery color

Variant	Loft Chair Upholstered seat	M-LFT-CU
Base Color	Black	BLCK
Back/seat color	Oak	OAK
Upholstery	Hallingdal	M146
Upholstery Color	226	810
Final Pattern No:	MLFTCUBLCKOAKM146810	

### Base/Wood Options

Steel Base and Wooden Seat/back are combined as follows

- BLCK-BLCK - Black/Black wood
- BLCK-OAK - Black/Oak
- DGRN-OAK - Dusty Green/Oak
- GREY-OAK - Grey/Oak
- DPRD-OAK - Deep Red/Oak

### Upholstery Options

A	B	C	E	R	T	U	V	W
Ocean (M161)* Remix (M156)	Canvas (M153) Clara (M154) Grain (M12659) Manner (M12665) Steelcut (M149) Steelcut Trio (M139)	Hallingdal (M146)	Acca (M12660) Beck (M6376) Divina (M150) Divina MD (M147) Divina Melange (M135) Ecriture (M10767) Hearth (M12664) Twill Weave (M142)	Easy Leather (M141)	Refine Leather (M136)	Endure Leather (M137)	Grace Leather (M12374)	Allure Leather (M12375)

\*Notes:  
Ocean - Color 3, 21, 32, 50, 52, 80 & 601

# MIDST TABLE

FOR MORE INFORMATION,  
EXPLORE BELOW

- ↗ [Product Fact Sheet](#)
- ↗ [Images](#)
- ↗ [Architect Files](#)
- ↗ [Assembly Instructions](#)
- ↗ [Product Declaration](#)

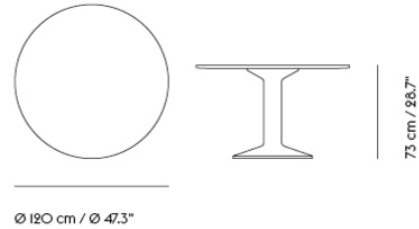

**Shipper Colli** 2  
**Gross Weight (kg)** 67,09  
**Net Weight (kg)** 48,996  
**Please note** Other color combinations are available upon request  
**Warranty Period** 10 years

Pattern No.	Color	Contract Price	Lead Time
<b>Ready-To-Ship EU Warehouse</b>			
MMDSTT47-BLCK-BLCK	Black Linoleum/Black	USD 4,146.00	-
MMDSTT47-DKRD-DKRD	Dark Red Linoleum/Dark Red	USD 4,146.00	-
MMDSTT47-DOAK-BLCK	Dark Oiled Oak/Black	USD 4,405.00	-
MMDSTT47-DOAK-DKRD	Dark Oiled Oak/Dark Red	USD 4,405.00	-
MMDSTT47-DOAK-GREY	Dark Oiled Oak/Grey	USD 4,405.00	-
MMDSTT47-OAK-BLCK	Oiled Oak/Black	USD 4,405.00	-
MMDSTT47-OAK-DKRD	Oiled Oak/Dark Red	USD 4,405.00	-
MMDSTT47-OAK-GREY	Oiled Oak/Grey	USD 4,405.00	-

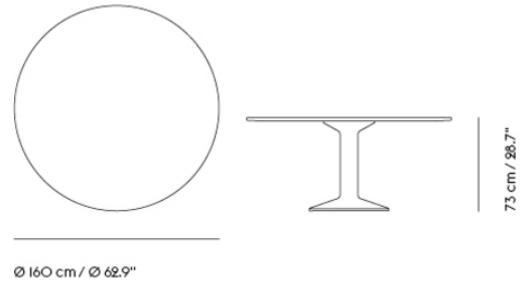

**Shipper Colli** 2  
**Gross Weight (kg)** 96.98  
**Net Weight (kg)** 74.217  
**Please note** Other color combinations are available upon request  
**Warranty Period** 10 years

Pattern No.	Color	Contract Price	Lead Time
<b>Ready-To-Ship EU Warehouse</b>			
MMDSTT63-BLCK-BLCK	Black Linoleum/Black	USD 5,770.00	-
MMDSTT63-DKRD-DKRD	Dark Red Linoleum/Dark Red	USD 5,770.00	-
MMDSTT63-DOAK-BLCK	Dark Oiled Oak/Black	USD 6,715.00	-
MMDSTT63-DOAK-DKRD	Dark Oiled Oak/Dark Red	USD 6,715.00	-
MMDSTT63-DOAK-GREY	Dark Oiled Oak/Grey	USD 6,715.00	-
MMDSTT63-OAK-BLCK	Oiled Oak/Black	USD 6,715.00	-
MMDSTT63-OAK-DKRD	Oiled Oak/Dark Red	USD 6,715.00	-
MMDSTT63-OAK-GREY	Oiled Oak/Grey	USD 6,715.00	-

# MINI STACKED STORAGE SYSTEM

FOR MORE INFORMATION,  
EXPLORE BELOW

- ↗ [Product Fact Sheet](#)
- ↗ [Images](#)
- ↗ [Architect Files](#)
- ↗ [Assembly Instructions](#)
- ↗ [Product Declaration](#)
- ↗ [Product Planner](#)

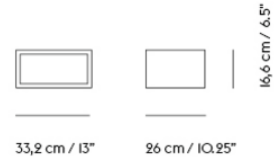
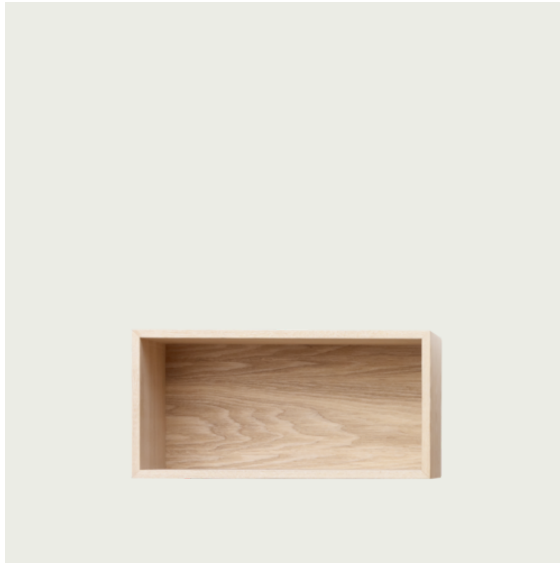

**Shipper Colli** 1  
**Gross Weight (kg)** 4.2  
**Net Weight (kg)** 2.7  
**Warranty Period** 5 years

Pattern No.	Color	Contract Price	Lead Time
<b>Ready-To-Ship US Warehouse</b>			
MMSTMSM-BRGR	Brown Green	USD 226.00	-
MMSTMSM-GREY	Grey ***	USD 226.00	-
MMSTMSM-MBLU	Midnight Blue ***	USD 226.00	-
MMSTMSM-OAK	Oak	USD 226.00	-
MMSTMSM-WHIT	White	USD 226.00	-

# MINI STACKED STORAGE SYSTEM / MEDIUM

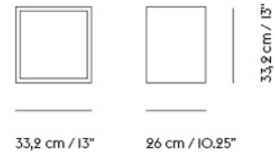

**Shipper Colli** 1  
**Gross Weight (kg)** 5.5  
**Net Weight (kg)** 3.7  
**Warranty Period** 5 years

Pattern No.	Color	Contract Price	Lead Time
<b>Ready-To-Ship US Warehouse</b>			
MMSTMMD-BRGR	Brown Green	USD 226.00	-
MMSTMMD-GREY	Grey ***	USD 226.00	-
MMSTMMD-OAK	Oak	USD 226.00	-
MMSTMMD-OLIGY	Oak/Grey ***	USD 226.00	-
MMSTMMD-WHIT	White	USD 226.00	-

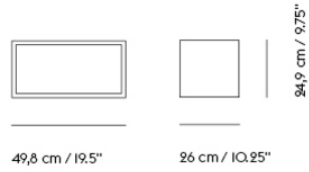

**Shipper Colli** | 1  
**Gross Weight (kg)** 6.195  
**Net Weight (kg)** 4.3  
**Warranty Period** 5 years

Pattern No.	Color	Contract Price	Lead Time
<b>Ready-To-Ship US Warehouse</b>			
MMSTMLG-BRGR	Brown Green	USD 236.00	-
MMSTMLG-GREY	Grey ***	USD 236.00	-
MMSTMLG-MBLU	Midnight Blue ***	USD 236.00	-
MMSTMLG-OAK	Oak	USD 236.00	-
MMSTMLG-WHIT	White	USD 236.00	-



**MINI STACKED STORAGE SYSTEM / EXTRA CLIPS (1 PC)**

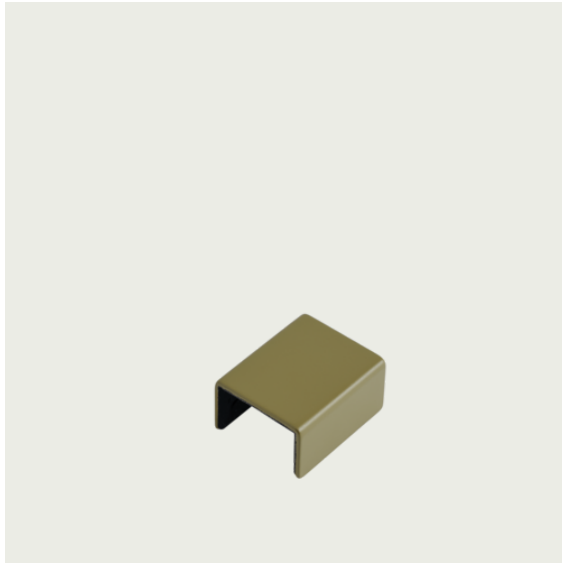

**Shipper Colli** 1  
**Gross Weight (kg)** 0.016  
**Net Weight (kg)** 0.014  
**Warranty Period** 5 years

Pattern No.	Color	Contract Price	Lead Time
<b>Ready-To-Ship US Warehouse</b>			
MMSTC1PC-BRGR	Brown Green	USD 18.00	-
MMSTC1PC/GREY	Grey	USD 18.00	-
MMSTC1PC/WHIT	White	USD 18.00	-

# MINI STACKED STORAGE SYSTEM / CLIPS SET OF 5



Shipper Colli	1
Gross Weight (kg)	0.077
Net Weight (kg)	0.071
Warranty Period	5 years

Pattern No.	Color	Contract Price	Lead Time
<b>Ready-To-Ship US Warehouse</b>			
MMSTC-GREY	Grey - Set of 5 ***	USD 39.00	-
MMSTC-LIGY	Light Grey - Set of 5 ***	USD 39.00	-
MMSTC-MBLU	Midnight Blue - Set of 5 ***	USD 39.00	-
<b>Ready-To-Ship EU Warehouse</b>			
MMSTC-DGRN	Dusty Green - Set of 5 ***	USD 39.00	-

# NERD CHAIR SERIES

FOR MORE INFORMATION,  
EXPLORE BELOW

- ↗ [Product Fact Sheet](#)
- ↗ [Images](#)
- ↗ [Architect Files](#)
- ↗ [Product Declaration](#)



**Shipper Colli** |  
**Gross Weight (kg)** 6.9  
**Net Weight (kg)** 4.5  
**Warranty Period** 5 years

Pattern No.	Color	Contract Price	Lead Time
<b>Ready-To-Ship US Warehouse</b>			
MNRDCW-BLCK	Black	USD 572.00	-
MNRDCW-GREN	Green	USD 572.00	-
MNRDCW-GREY	Grey	USD 572.00	-
MNRDCW-MBLU	Midnight Blue	USD 572.00	-
MNRDCW-OAK	Oak	USD 572.00	-
MNRDCW-SYEL	Sand Yellow ***	USD 572.00	-
MNRDCW-STDB	Stained Dark Brown	USD 572.00	-
MNRDCW-TROS	Tan Rose	USD 572.00	-
MNRDCW-WHIT	White	USD 572.00	-
<b>Extras</b>			
MGLDNSWCFB4	Felt glides for Nerd Series and Workshop Chair and Bench (4 pcs per pack) - Black	USD 21.00	-
MGLDNSWCFG4	Felt glides for Nerd Series and Workshop Chair and Bench (4 pcs per pack) - Grey	USD 21.00	-

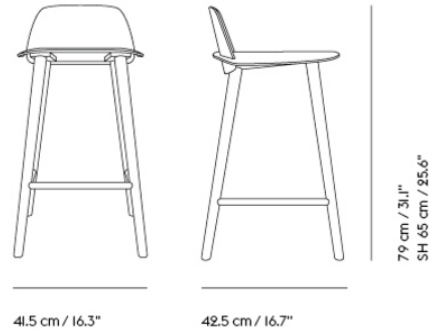

Shipper Colli 1  
 Gross Weight (kg) 5.6  
 Net Weight (kg) 4.3  
 Warranty Period 5 years

Pattern No.	Color	Contract Price	Lead Time
<b>Ready-To-Ship US Warehouse</b>			
MNRDSTCW-BLCK	Black	USD 667.00	-
MNRDSTCW-GREN	Green	USD 667.00	-
MNRDSTCW-GREY	Grey	USD 667.00	-
MNRDSTCW-MBLU	Midnight Blue	USD 667.00	-
MNRDSTCW-OAK	Oak	USD 667.00	-
MNRDSTCW-STD	Stained Dark Brown	USD 667.00	-
MNRDSTCW-TROS	Tan Rose	USD 667.00	-
<b>Made-To-Order</b>			
MNRDSTCWF-BLCK	Black - With Steel Foot Protect	USD 719.00	13-15 weeks
MNRDSTCWF-GREN	Green - With Steel Foot Protect	USD 719.00	13-15 weeks
MNRDSTCWF-GREY	Grey - With Steel Foot Protect	USD 719.00	13-15 weeks
MNRDSTCWF-MBLU	Midnight Blue - With Steel Foot Protect	USD 719.00	13-15 weeks
MNRDSTCWF-OAK	Oak - With Steel Foot Protect	USD 719.00	13-15 weeks
MNRDSTCWF-SYEL	Sand Yellow - With Steel Foot Protect	USD 719.00	13-15 weeks
MNRDSTCWF-STD	Stained Dark Brown - With Steel Foot Protect	USD 719.00	13-15 weeks
MNRDSTCWF-TROS	Tan Rose - With Steel Foot Protect	USD 719.00	13-15 weeks
<b>Extras</b>			
MGLDNSWCFB4	Felt glides for Nerd Series and Workshop Chair and Bench (4 pcs per pack) - Black	USD 21.00	-
MGLDNSWCFG4	Felt glides for Nerd Series and Workshop Chair and Bench (4 pcs per pack) - Grey	USD 21.00	-

Pattern No.	Color	Contract Price	Lead Time
MFTRSTN	Steel Footrest Protector - Self-Mounting	USD 48.00	-

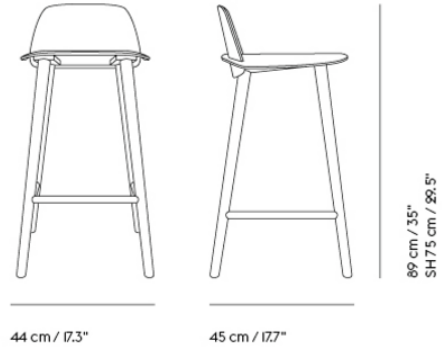

**Shipper Colli** 1  
**Gross Weight (kg)** 5.6  
**Net Weight (kg)** 4.3  
**Warranty Period** 5 years

Pattern No.	Color	Contract Price	Lead Time
<b>Ready-To-Ship US Warehouse</b>			
MNRDSTBW-BLCK	Black	USD 667.00	-
MNRDSTBW-GREN	Green	USD 667.00	-
MNRDSTBW-GREY	Grey	USD 667.00	-
MNRDSTBW-MBLU	Midnight Blue	USD 667.00	-
MNRDSTBW-OAK	Oak	USD 667.00	-
MNRDSTBW-SYEL	Sand Yellow ***	USD 667.00	-
MNRDSTBW-STD	Stained Dark Brown	USD 667.00	-
MNRDSTBW-TROS	Tan Rose	USD 667.00	-
MNRDSTBW-WHIT	White	USD 667.00	-
<b>Made-To-Order</b>			
MNRDSTBWF-BLCK	Black - With Steel Foot Protect	USD 719.00	13-15 weeks
MNRDSTBWF-GREN	Green - With Steel Foot Protect	USD 719.00	13-15 weeks
MNRDSTBWF-GREY	Grey - With Steel Foot Protect	USD 719.00	13-15 weeks
MNRDSTBWF-MBLU	Midnight Blue - With Steel Foot Protect	USD 719.00	13-15 weeks
MNRDSTBWF-OAK	Oak - With Steel Foot Protect	USD 719.00	13-15 weeks
MNRDSTBWF-SYEL	Sand Yellow - With Steel Foot Protect	USD 719.00	13-15 weeks
MNRDSTBWF-STD	Stained Dark Brown - With Steel Foot Protect	USD 719.00	13-15 weeks
MNRDSTBWF-TROS	Tan Rose - With Steel Foot Protect	USD 719.00	13-15 weeks

**Extras**

Pattern No.	Color	Contract Price	Lead Time
MGLDNSWCFB4	Felt glides for Nerd Series and Workshop Chair and Bench (4 pcs per pack) - Black	USD 21.00	-
MGLDNSWCFG4	Felt glides for Nerd Series and Workshop Chair and Bench (4 pcs per pack) - Grey	USD 21.00	-
MFTRSTN	Steel Footrest Protector - Self-Mounting	USD 48.00	-



# OSLO CHAIR SERIES

FOR MORE INFORMATION,  
EXPLORE BELOW

- ↗ [Product Fact Sheet](#)
- ↗ [Images](#)
- ↗ [Architect Files](#)
- ↗ [Product Declaration](#)
- ↗ [Product Configurator](#)

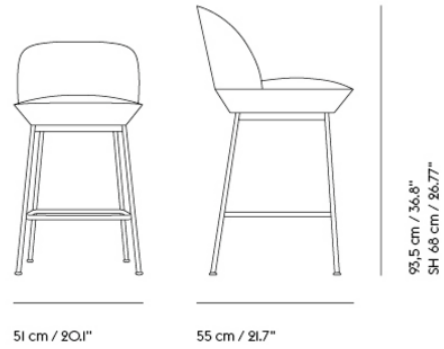

Shipper Colli	1
Gross Weight (kg)	10
Net Weight (kg)	8
Base color options	Chrome or Anthracite Black
Warranty Period	10 years

Pattern No.	Color	Contract Price	Lead Time
<b>Ready-To-Ship US Warehouse</b>			
MOSLSTCU-CHRO-M16132	Ocean 32/Chrome ***	USD 1,045.00	-
<b>Extras</b>			
MGLDOFVTBPB1	Plastic glides for Oslo and Fiber with Tube Base (1 pc per pack) - Black	USD 6.00	-
MGLDOFVTBFB4	Felt Glides for Oslo and Fiber with Tube Base (4 pcs per pack)	USD 21.00	-

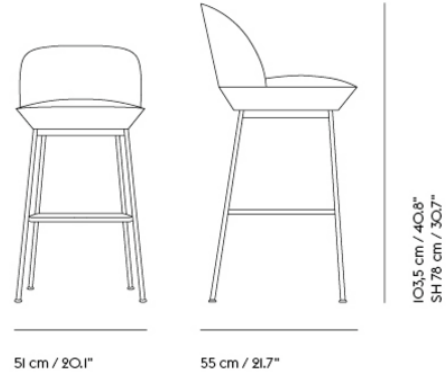

Shipper Colli	I
Gross Weight (kg)	11
Net Weight (kg)	8.2
Base color options	Chrome or Anthracite Black
Warranty Period	10 years

Pattern No.	Color	Contract Price	Lead Time
<b>Ready-To-Ship US Warehouse</b>			
MOSLSTBU-CHRO-M16132	Ocean 32/Chrome ***	USD 1,045.00	-
<b>Extras</b>			
MGLDOFVTBPB1	Plastic glides for Oslo and Fiber with Tube Base (1 pc per pack) - Black	USD 6.00	-
MGLDOFVTBFB4	Felt Glides for Oslo and Fiber with Tube Base (4 pcs per pack)	USD 21.00	-



OSLO CHAIR

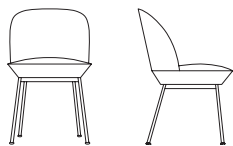

51 cm / 20.08"      56 cm / 22.05"

80,5 cm / 31.7"  
SH 45 cm / 17.75"

OSLO COUNTER STOOL

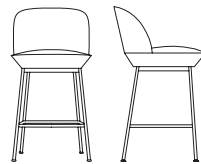

51 cm / 20.1"      55 cm / 21.7"

93,5 cm / 36.8"  
SH 65 cm / 25.6"

OSLO BAR STOOL

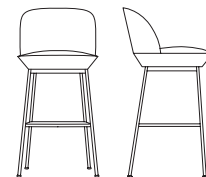

51 cm / 20.1"      55 cm / 21.7"

103,5 cm / 40.8"  
SH 75 cm / 29.5"

## All Variants

	Pattern No.	Upholstery Grades			
		A	B	C	E
Oslo Side Chair	M-OSLS-U	954	1,045	1,150	1,150
Oslo Counter Stool	M-OSLST-C-U	1,045	1,150	1,255	1,255
Oslo Bar Stool	M-OSLST-B-U	1,045	1,150	1,255	1,255

## HOW TO CONFIGURE

Specify:

- Step 1: Choose variant
- Step 2: Choose base color
- Step 3: Choose textile
- Step 4: Choose textile color

## ORDER CODE EXAMPLE:

Oslo Side Chair in Steelcut Trio 226 w/chrome base

Variant	Oslo Side Chair	MOSLSU
Base Color	Chrome	CHRO
Textile	Steelcut Trio	M139
Textile Color	226	226
Final Pattern No:	MOSLSUCHROM139226	

## Base Finish Options

- BLCK - Anthracite Black
- CHRO - Chrome

## Upholstery Options

A	B	C	E
Ocean (M161)*	Clara (M154) Fiord (M155) Grain (M12659) Manner (M12665) Re-Wool (M4586) Sabi (M8404) Steelcut (M149) Steelcut Trio (M139)	Hallingdal (M146)	Divina (M150) Divina MD (M147) Divina Melange (M135) Ecriture (M10767) Twill Weave (M142) Vidar (M158)

\*Notes:  
Ocean - Color 3, 21, 32, 50, 52, 80 & 601

# OSLO LOUNGE SERIES

FOR MORE INFORMATION,  
EXPLORE BELOW

- ↗ [Product Fact Sheet](#)
- ↗ [Images](#)
- ↗ [Architect Files](#)
- ↗ [Product Declaration](#)
- ↗ [Product Configurator](#)

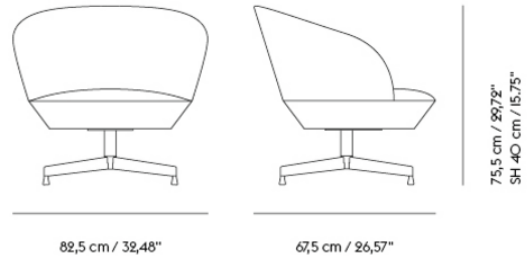

Shipper Colli	1
Gross Weight (kg)	23.5
Net Weight (kg)	21.5
Base color options	Black or Grey
Warranty period	10 years

Pattern No.	Color	Contract Price	Lead Time
-------------	-------	----------------	-----------

**Ready-To-Ship US Warehouse**

MOSLLCS-BLCK-M142990	Twill Weave 990/Black	USD 3,621.00	-
MOSLLCS-GREY-M158146	Vidar 146/Grey	USD 3,621.00	-

**Extras**

MLEAKIT	Leather care set for Refine Leather	USD 27.00	-
---------	-------------------------------------	-----------	---

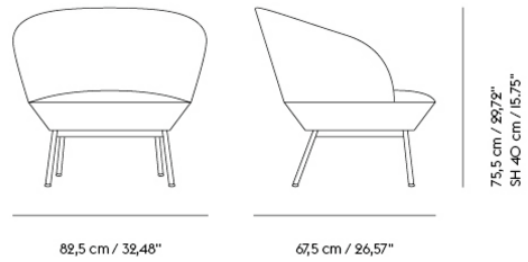

Shipper Colli	1
Gross Weight (kg)	23.5
Net Weight (kg)	21.5
Base color options	Black or Grey
Warranty period	10 years

Pattern No.	Color	Contract Price	Lead Time
-------------	-------	----------------	-----------

**Ready-To-Ship US Warehouse**

MOSLLCT-BLCK-M142990	Twill Weave 990/Black	USD 2,935.00	-
MOSLLCT-GREY-M158146	Vidar 146/Grey	USD 2,935.00	-

**Extras**

MLEAKIT	Leather care set for Refine Leather	USD 27.00	-
---------	-------------------------------------	-----------	---

# OSLO LOUNGE CHAIR



## All Upholstery Variants

All Variants

	Pattern No.	Upholstery Grades							
		COM				CIL			
		B	C	E	R	T	U	V	W
Oslo Lounge Chair Tube Base	MOSLLCT	2,571	2,676	2,935	3,096	3,516	3,565	4,090	4,146
Oslo Lounge Chair Swivel Base	MOSLLCS	2,935	3,096	3,621	3,775	4,090	4,146	4,510	4,566

### HOW TO CONFIGURE

Specify:

- Step 1: Choose variant
- Step 2: Choose base color
- Step 3: Choose textile
- Step 4: Choose textile color

### ORDER CODE EXAMPLE

Oslo Lounge Chair Tube Base in Colline 227

Variant	Oslo Lounge Chair Tube base	MOSLLCT
Base Color	Black	BLCK
Textile	Divina	M150
Textile Color	135	135
Final Pattern No:	MOSLLCTBLCKM150135	

### Base Finish Options

- BLCK - Black
- GREY - Grey

### Upholstery Options

B	C	E	R	T	U	V	W
Canvas (M153) Clara (M154) Fiord (M155) Grain (M12659) Manner (M12665) Re-Wool (M4586) Sabi (M8404) Steelcut (M149) Steelcut Trio (M139)	Hallingdal (M146)	Acca (M12660) Beck (M6376) Divina (M150) Divina MD (M147) Divina Melange (M135) Hearth (M12664) Twill Weave (M142) Vidar (M158)	Easy Leather (M141)	Refine Leather (M136)	Endure Leather (M137)	Grace Leather (M12374)	Allure Leather (M12375)



# OSLO SOFA SERIES

FOR MORE INFORMATION,  
EXPLORE BELOW

- ↗ [Product Fact Sheet](#)
- ↗ [Images](#)
- ↗ [Architect Files](#)
- ↗ [Assembly Instructions](#)
- ↗ [Product Declaration](#)
- ↗ [Product Configurator](#)

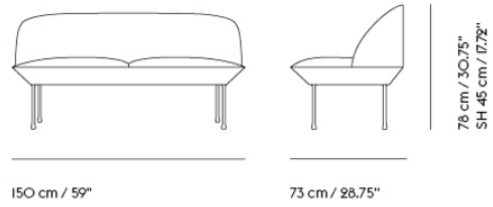

Shipper Colli	1
Gross Weight (kg)	34
Net Weight (kg)	31
Base color options	Black, Chrome, Dark Grey or Grey
Warranty Period	10 years

Pattern No.	Color	Contract Price	Lead Time
<b>Ready-To-Ship US Warehouse</b>			
MOSLSF2-NABL-M158554	Vidar 554/Navy Blue ***	USD 4,615.00	-
<b>Extras</b>			
MLEAKIT	Leather care set for Refine Leather	USD 27.00	-

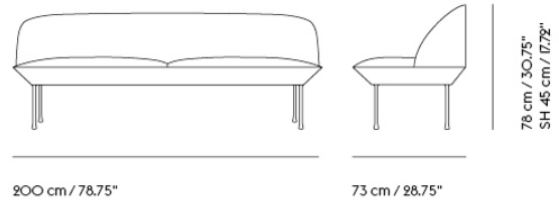

Shipper Colli	1
Gross Weight (kg)	49
Net Weight (kg)	44
Base color options	Black, Chrome, Dark Grey or Grey
Warranty Period	10 years

Pattern No.	Color	Contract Price	Lead Time
<b>Ready-To-Ship US Warehouse</b>			
MOSLSF3-DKGY-M149180	Steelcut 180/Dark Grey ***	USD 4,615.00	-
MOSLSF3-DKGY-M139966	Steelcut Trio 966/Dark Grey	USD 4,615.00	-
MOSLSF3-NABL-M158554	Vidar 554/Navy Blue ***	USD 5,406.00	-
<b>Extras</b>			
MLEAKIT	Leather care set for Refine Leather	USD 27.00	-

# OSLO SOFA SERIES



OSLO SOFA 3-SEATER

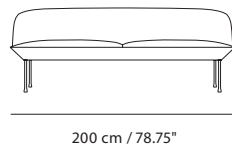

OSLO SOFA 2-SEATER

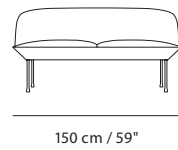

78 cm / 30.75"  
SH 45 cm / 17.75"

OSLO SOFA 1-SEATER

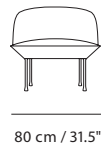

78 cm / 30.75"  
SH 45 cm / 17.75"

OSLO BENCH

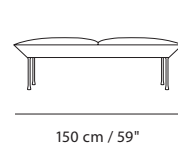

Oslo Pouf:  
Shipper colli 1  
Gross Weight (kg) 17  
Net Weight (kg) 16  
Warranty Period 10 years

Oslo 1-Seater:  
Shipper colli 1  
Gross Weight (kg) 23  
Net Weight (kg) 20  
Warranty Period 10 years

Oslo Sofa 3-Seater:  
Shipper colli: 1  
Gross Weight (kg) 46  
Net Weight (kg) 44  
Warranty Period 10 years

OSLO POUF

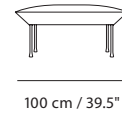

45 cm / 17.75"

Oslo Bench:  
Shipper colli: 1  
Gross Weight (kg) 34  
Net Weight (kg) 32  
Warranty Period 10 years

Oslo Sofa 2-Seater:  
Shipper colli: 1  
Gross Weight (kg) 34  
Net Weight (kg) 32  
Warranty Period 10 years

## All Variants

	Pattern No.	Upholstery Grades								
		A	COM B	CIL C	E	R	T	U	V	W
Oslo Sofa 2-seater	M-OSLSF-2	3,565	4,090	4,300	4,615	4,776	5,140	5,245	5,721	5,770
Oslo Sofa 3-seater	M-OSLSF-3	4,300	4,615	4,986	5,406	5,616	5,980	6,036	6,561	6,771
Oslo 1-Seater	M-OSLSF-1	2,305	2,515	2,676	2,935	3,096	3,516	3,565	4,090	4,146
Oslo Bench	M-OSLB	2,361	2,571	2,830	3,040	3,096	3,411	3,516	3,726	3,831
Oslo Pouf	M-OSLP	1,836	1,941	2,256	2,305	2,361	2,781	2,830	3,040	3,096

## HOW TO CONFIGURE

Specify:  
Step 1: Choose variant  
Step 2: Choose base color  
Step 3: Choose textile  
Step 4: Choose textile color

## ORDER CODE EXAMPLE:

Oslo 2-seater in Steelcut Trio 226 w/chrome base  
Variant Oslo 2-seater MOSLSF2  
Base Color Chrome CHRO  
Textile Steelcut Trio M139  
Textile Color 226  
Final Pattern No: MOSLSF2CHROM139226

## Base Finish Options

- BLCK - Black
- CHRO - Chrome
- DKGY - Dark Grey
- GREY - Grey

## Upholstery Options

A	B	C	E	R	T	U	V	W
Ocean (M161)*	Canvas (M153) Clara (M154) Fiord (M155) Grain (M12659) Manner (M12665) Re-Wool (M4586) Sabi (M8404) Steelcut (M149) Steelcut Trio (M139)	Hallingdal (M146)	Acca (M12660) Beck (M6376) Divina (M150) Divina MD (M147) Divina Melange (M135) Hearth (M12664) Twill Weave (M142) Vidar (M158)	Easy Leather (M141)	Refine Leather (M136)	Endure Leather (M137)	Grace Leather (M12374)	Allure Leather (M12375)

\*Notes:  
Ocean - Color 3, 21, 32, 50, 52, 80 & 601

# OUTLINE SOFA SERIES

FOR MORE INFORMATION,  
EXPLORE BELOW

- ↗ [Product Fact Sheet](#)
- ↗ [Images](#)
- ↗ [Architect Files](#)
- ↗ [Assembly Instructions](#)
- ↗ [Product Declaration](#)
- ↗ [Product Configurator](#)

The Outline Sofa Family adds new perspectives to the classic Scandinavian design sofas of the 1960's, marrying the ideals of simplicity and function into one. With the design taking its name from its strong outline of a sofa, the Outline family is clean and elegant on the outside with a deep seat and soft cushioning on its inside.

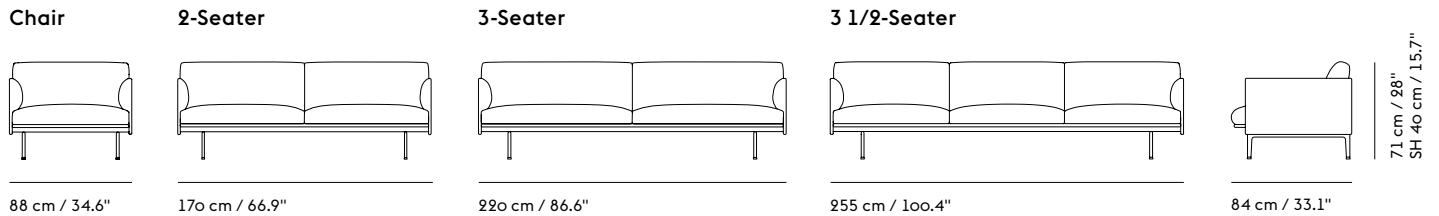

71 cm / 28"  
SH 40 cm / 15.7"

**Chaise Longue Left**

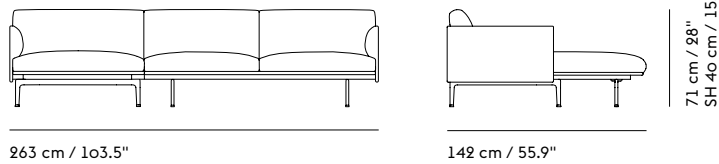

**Chaise Longue Right**

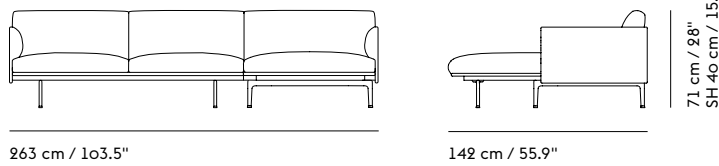

**Corner**

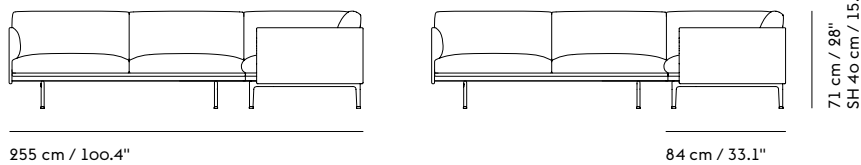

**Pouf**

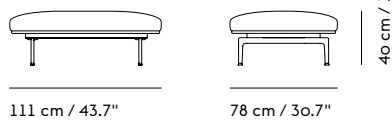

**Daybed & Daybed Cushion**

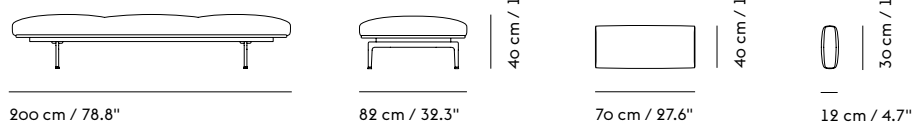

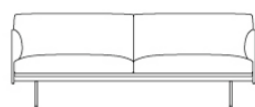

170 cm / 66.9"



84 cm / 33.1"

71 cm / 28"  
SH 40 cm / 15.7"

Shipper Colli	1
Gross Weight (kg)	55
Net Weight (kg)	50
Warranty Period	10 years

Pattern No.	Color	Contract Price	Lead Time
<b>Ready-To-Ship US Warehouse</b>			
MOUSF2-BLCK-M156163	Remix I63/Black	USD 4,405.00	-
MOUSF2-BLCK-K23401	Attire I/Black ***	USD 5,140.00	-
MOUSF2-BLCK-M136COGN	Refine Leather Cognac/Black	USD 7,240.00	-
<b>Extras</b>			
MLEAKIT	Leather care set for Refine Leather	USD 27.00	-
MPWROUT	Power Outlet - Black	USD 572.00	-

# OUTLINE SOFA / 2-SEATER - POLISHED ALUMINUM BASE

357

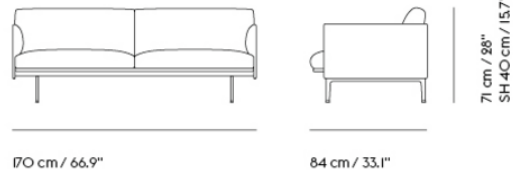

**Shipper Colli** 1  
**Gross Weight (kg)** 55  
**Net Weight (kg)** 50  
**Warranty Period** 10 years

Pattern No.	Color	Contract Price	Lead Time
<b>Ready-To-Ship US Warehouse</b>			
MOUTSF2-ALU-M150984	Divina 984/Polished Aluminum ***	USD 5,875.00	-
<b>Ready-To-Ship EU Warehouse</b>			
MOUTSF2-ALU-M10767240	Ecriture 240/Polished Aluminum	USD 5,875.00	-
<b>Extras</b>			
MLEAKIT	Leather care set for Refine Leather	USD 27.00	-
MPWR0UT	Power Outlet - Black	USD 572.00	-



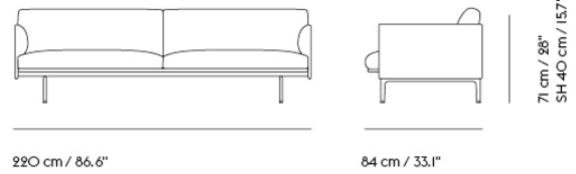

Shipper Colli |  
 Gross Weight (kg) 74  
 Net Weight (kg) 69  
 Warranty Period 10 years

Pattern No.	Color	Contract Price	Lead Time
<b>Ready-To-Ship US Warehouse</b>			
MOUSF3-BLCK-M156163	Remix I63/Black	USD 4,825.00	-
MOUSF3-BLCK-K23401	Attire I/Black ***	USD 5,721.00	-
MOUSF3-BLCK-M136COGN	Refine Leather Cognac/Black	USD 8,031.00	-
<b>Extras</b>			
MLEAKIT	Leather care set for Refine Leather	USD 27.00	-
MPWROUT	Power Outlet - Black	USD 572.00	-

# OUTLINE SOFA / 3-SEATER - POLISHED ALUMINUM BASE

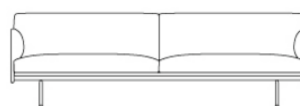

220 cm / 86.6"

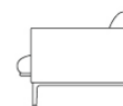

84 cm / 33.1"

71 cm / 28"  
SH 40 cm / 15.7"

Shipper Colli	1
Gross Weight (kg)	74
Net Weight (kg)	69
Warranty Period	10 years

Pattern No.	Color	Contract Price	Lead Time
<b>Ready-To-Ship US Warehouse</b>			
MOUTSF3-ALU-M150984	Divina 984/Polished Aluminum ***	USD 6,561.00	-
<b>Ready-To-Ship EU Warehouse</b>			
MOUTSF3-ALU-M10767240	Ecriture 240/Polished Aluminum	USD 6,561.00	-
<b>Extras</b>			
MLEAKIT	Leather care set for Refine Leather	USD 27.00	-
MPWR0UT	Power Outlet - Black	USD 572.00	-

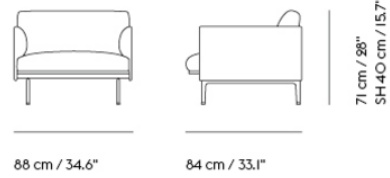

Shipper Colli |  
 Gross Weight (kg) 35  
 Net Weight (kg) 30  
 Warranty Period 10 years

Pattern No.	Color	Contract Price	Lead Time
<b>Ready-To-Ship US Warehouse</b>			
MOUTC-BLCK-M156163	Remix I63/Black	USD 3,096.00	-
MOUTC-BLCK-K23401	Attire I/Black ***	USD 3,516.00	-
MOUTC-BLCK-M136COGN	Refine Leather Cognac/Black	USD 4,671.00	-
<b>Extras</b>			
MLEAKIT	Leather care set for Refine Leather	USD 27.00	-
MPWROUT	Power Outlet - Black	USD 572.00	-

# OUTLINE CHAIR / POLISHED ALUMINUM BASE

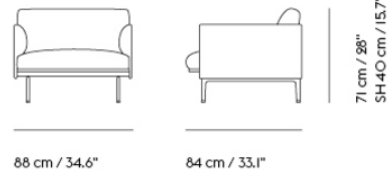

**Shipper Colli** 1  
**Gross Weight (kg)** 35  
**Net Weight (kg)** 30  
**Warranty Period** 10 years

Pattern No.	Color	Contract Price	Lead Time
<b>Ready-To-Ship US Warehouse</b>			
MOUTC-ALU-M150984	Divina 984/Polished Aluminum ***	USD 4,041.00	-
<b>Ready-To-Ship EU Warehouse</b>			
MOUTC-ALU-M10767240	Ecriture 240/Polished Aluminum	USD 4,041.00	-
<b>Extras</b>			
MLEAKIT	Leather care set for Refine Leather	USD 27.00	-
MPWR0UT	Power Outlet - Black	USD 572.00	-

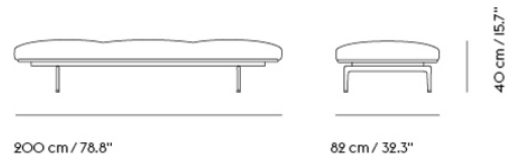
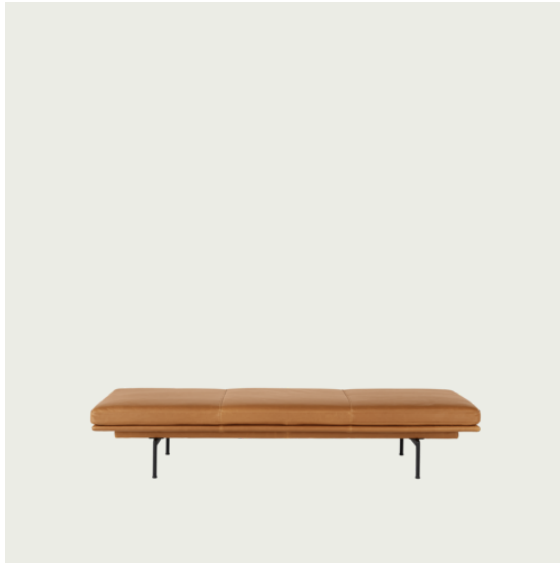

Shipper Colli 1  
 Gross Weight (kg) 50  
 Net Weight (kg) 40  
 Warranty Period 5 years

Pattern No.	Color	Contract Price	Lead Time
<b>Ready-To-Ship EU Warehouse</b>			
MOUJD-BLCK-M136COGN	Refine Leather Cognac/Black	USD 5,350.00	-
<b>Extras</b>			
MLEAKIT	Leather care set for Refine Leather	USD 27.00	-
MPWROUT	Power Outlet - Black	USD 572.00	-



**Shipper Colli** 1  
**Gross Weight (kg)** 4  
**Net Weight (kg)** 1.35  
**Warranty Period** 5 years

Pattern No.	Color	Contract Price	Lead Time
<b>Ready-To-Ship EU Warehouse</b>			
MOUTDC-M136COGN	Refine Leather Cognac	USD 629.00	-
<b>Extras</b>			
MLEAKIT	Leather care set for Refine Leather	USD 27.00	-



## All Variants

	Pattern No.	Base Color	Upholstery Grades									
			A	B	C	E	G	R	T	U	V	W
Outline Chair	M-OUT-C-BLCK	black	3,096	3,516	3,621	3,775	4,090	4,146	4,671	5,616	5,721	6,085
	M-OUT-C-ALU	aluminum	3,355	3,775	3,880	4,041	4,356	4,405	4,986	5,875	5,980	6,351
Outline 2-seater	M-OUT-SF-2-BLCK	black	4,405	5,140	5,406	5,616	5,875	6,876	7,240	8,920	9,081	9,816
	M-OUT-SF-2-ALU	aluminum	4,671	5,406	5,721	5,875	6,141	7,191	7,506	9,186	9,340	10,131
Outline 3-seater	M-OUT-SF-3-BLCK	black	4,825	5,721	5,980	6,295	6,561	7,450	8,031	10,180	10,446	11,545
	M-OUT-SF-3-ALU	aluminum	5,091	5,980	6,246	6,561	6,820	7,765	8,290	10,446	11,020	11,545
Outline 3.5-seater	M-OUT-SF-35-BLCK	black	5,511	6,141	6,876	7,030	7,296	8,920	9,340	12,070	12,070	12,595
	M-OUT-SF-35-ALU	aluminum	5,770	6,456	7,191	7,296	7,555	9,186	9,606	12,595	12,595	13,120
Outline Daybed	M-OUT-D-BLCK	black	3,306	3,775	4,041	4,090	4,356	4,405	5,350	5,980	6,141	6,351
	M-OUT-D-ALU	aluminum	3,565	4,041	4,300	4,356	4,615	4,671	5,616	6,246	6,456	6,610
Outline Daybed cushion	M-OUT-DC		450	520	576	597	614	614	629	719	776	807

## HOW TO CONFIGURE

Specify:

- Step 1) Choose Variant + base color
- Step 2) Upholstery option
- Step 3) Upholstery color

## ORDER CODE EXAMPLE:

Outline 2-seater sofa in Ocean 80 w/black base

Variant + base color    Outline 2-seater sofa    MOUTSF2-BLCK  
 Upholstery option    Ocean    M161  
 Upholstery Color    80  
 Final Pattern No:    MOUTSF2BLCKM16180

## Base Finish Options

- BLCK - Black
- ALU - Aluminum

## Upholstery Options

A	B	C	E	G	R	T	U	V	W
Mode (M2319) Ocean (M161)* Remix (M156)	Cameo (K1443) Canvas (M153) Clara (M154) Fiord (M155) Grain (M12659) Manner (M12665) Pebble Weave (M6374) ** Pecora (M6372) ** Prairie (K1925)* Steelcut (M149) Steelcut Trio (M139) Steelcut Quartet (M13042)	Chameleon (K2372) Color Field (K2226) Hallingdal (M146)	Acca (M12660) Aegean (K2074) Balder (M152) Beck (M6376) Divina (M150) Divina MD (M147) Divina Melange (M135) Ecriture (M10767) Hearth (M12664) Premiere (K2294) Twill Weave (M142) Vidar (M158)	Modern Tweed (K2155)	Easy Leather (M141)	Refine Leather (M136)	Endure Leather (M137)	Grace Leather (M12374)	Allure Leather (M12375)

\*Notes:  
 \*Ocean: Color 3, 21, 32, 50, 52, 80 & 601  
 Pebble Weave: Color 3, 7, 8, 11, 12, 21  
 Pecora: Color 6049, 6083, 6084, 6093, 60112  
 \*Prairie: All Additive Free (ADF) Colors

# OUTLINE SOFA SERIES – 2/2

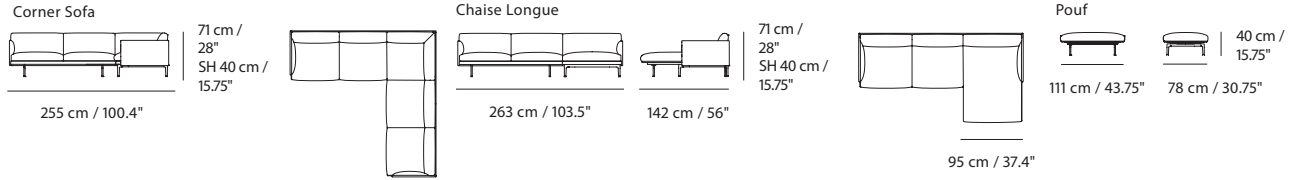

Outline Corner:  
 Shipper Colli 2  
 Gross Weight (kg) 122  
 Net Weight (kg) 112  
 Warranty Period 10 years

Outline Chaise Longue:  
 Shipper Colli 2  
 Gross Weight (kg) 90  
 Net Weight (kg) 80  
 Directional modules Right and left refers to the side when facing the product from the front.  
 Warranty Period 10 years

Outline Pouf:  
 Shipper Colli 1  
 Gross Weight (kg) 23  
 Net Weight (kg) 17  
 Warranty Period 10 years

## All Variants

	Pattern No.	Base Color	Upholstery Grades									
			A	B	C	E	G	R	T	U	V	W
Outline Corner sofa	M-OUT-CS-BLCK	black	8,556	9,970	11,020	11,545	11,545	14,170	15,745	18,895	20,995	22,045
	M-OUT-CS-ALU	aluminum	9,081	10,495	11,545	12,070	12,070	14,695	16,270	19,420	21,520	23,095
Outline Chaise lounge - left	M-OUT-CL-L-BLCK	black	7,030	7,555	8,500	8,920	9,340	10,446	11,020	13,645	14,695	16,270
	M-OUT-CL-L-ALU	aluminum	7,450	7,975	8,920	9,291	9,760	11,020	11,545	14,170	15,745	16,270
Outline Chaise lounge - right	M-OUT-CL-R-BLCK	black	7,030	7,555	8,500	8,920	9,340	10,446	11,020	13,645	14,695	16,270
	M-OUT-CL-R-ALU	aluminum	7,450	7,975	8,920	9,291	9,760	11,020	11,545	14,170	15,745	16,270
Outline Pouf	M-OUT-P-BLCK	black	1,570	1,836	2,095	2,515	2,571	2,620	2,571	3,306	3,355	3,621
	M-OUT-P-ALU	aluminum	1,836	2,095	2,361	2,781	2,830	2,886	2,830	3,565	3,621	3,880

## HOW TO CONFIGURE

Specify:

- Step 1) Choose Variant + base color
- Step 2) Upholstery option
- Step 3) Upholstery color

## ORDER CODE EXAMPLE:

Outline 2-seater sofa in Ocean 80 w/black base

Variant + base color Outline 2-seater sofa MOUTSF2-BLCK  
 Upholstery option Ocean M161  
 Upholstery Color 80 80  
 Final Pattern No: MOUTSF2BLCKM16180

## Base Finish Options

BLCK - Black  
 ALU - Aluminum

## Upholstery Options

A	B	C	E	G	R	T	U	V	W
Mode (M2319) Ocean (M161)* Remix (M156)	Cameo (K1443) Canvas (M153) Clara (M154) Fiord (M155) Grain (M12659) Manner (M12665) Pebble Weave (M6374) ** Pecora (M6372) *** Prairie (K1925)* Steelcut (M149) Steelcut Trio (M139) Steelcut Quartet (M13042)*** Steelcut Quartet (M13042)***	Chameleon (K2372) Color Field (K2226) Hallingdal (M146)	Acca (M12660) Aegean (K2074) Balder (M152) Beck (M6376) Divina (M150) Divina MD (M147) Divina Melange (M135) Ecriture (M10767) Hearth (M12664) Premiere (K2294) Twill Weave (M142) Vidar (M158)	Modern Tweed (K2155)	Easy Leather (M141)	Refine Leather (M136)	Endure Leather (M137)	Grace Leather (M12374)	Allure Leather (M12375)

\*Notes:  
 \*Ocean: Color 3, 21, 32, 50, 52, 80 & 601  
 \*\*Pebble Weave: Color 3, 7, 8, 11, 12, 21  
 \*\*\*Pecora: Color 6049, 6083, 6084, 6093, 60112  
 \*Prairie: All Additive Free (ADF) Colors  
 \*\*\* Not available on the Outline Corner Sofa or Chaise





140 cm / 55.1" - both heights:  
 Shipper Colli 1  
 Gross Weight (kg) 41  
 Net Weight (kg) 36  
 Warranty Period 10 years

170 cm / 66.9" - both heights:  
 Shipper Colli 1  
 Gross Weight (kg) 64  
 Net Weight (kg) 50  
 Warranty Period 10 years

220 cm / 86.6" - both heights:  
 Shipper Colli 1  
 Gross Weight (kg) 70  
 Net Weight (kg) 66  
 Warranty Period 10 years

## All Variants

STUDIO SOFA 220 CM / 86.6"

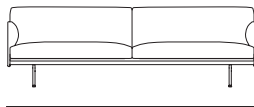

W 220 cm / 86.6"  
 SW 200 cm / 78.7"



76 cm / 29.9"  
 SD 54 cm / 21.3"

71 cm / 28"  
 SH 40 cm / 15.7"

STUDIO SOFA 220 CM / 86.6" — SH 45 CM / 17.7"

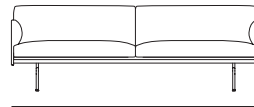

W 220 cm / 86.6"  
 SW 200 cm / 78.7"



76 cm / 29.9"  
 SD 54 cm / 21.3"

76 cm / 29.9"  
 SH 45 cm / 17.7"

STUDIO SOFA 170 CM / 66.9"

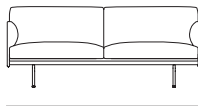

W 170 cm / 66.9"  
 SW 150 / 59.1"

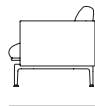

76 cm / 29.9"  
 SD 54 cm / 21.3"

71 cm / 28"  
 SH 40 cm / 15.7"

STUDIO SOFA 170 CM / 66.9" — SH 45 CM / 17.7"

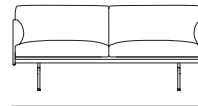

W 170 cm / 66.9"  
 SW 150 / 59.1"



76 cm / 29.9"  
 SD 54 cm / 21.3"

76 cm / 29.9"  
 SH 45 cm / 17.7"

STUDIO SOFA 140 CM / 55.1"

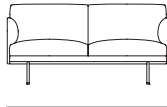

W 140 cm / 55.1"  
 SW 120 cm / 47.2"

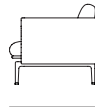

76 cm / 29.9"  
 SD 54 cm / 21.3"

71 cm / 28"  
 SH 40 cm / 15.75"

STUDIO 140 CM / 55.1" — SH 45 CM / 17.7"

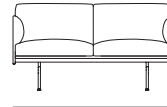

W 140 cm / 55.1"  
 SW 120 cm / 47.2"

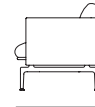

76 cm / 29.9"  
 SD 54 cm / 21.3"

76 cm / 29.9"  
 SH 45 cm / 17.7"

STUDIO CHAIR



W 78 cm / 30.7"  
 SW 60 cm / 23.6"

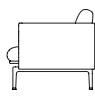

76 cm / 29.9"  
 SD 54 cm / 21.3"

STUDIO CHAIR — SH 45 CM / 17.7"



W 78 cm / 30.7"  
 SW 60 cm / 23.6"

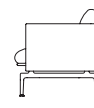

76 cm / 29.9"  
 SD 54 cm / 21.3"

76 cm / 29.9"  
 SH 45 cm / 17.7"

# OUTLINE STUDIO SOFA SERIES

## All Variants

Pattern No.	Seat Height	Base Color	Upholstery Grades									
			A	B	C	E	G	R	COL			
<b>Outline Studio 140 cm / 55" Sofa</b>												
M-OUT-SS-16-55-BLCK	15.75"	black	3,831	4,615	4,986	5,140	5,406	5,616	6,246	7,975	8,080	8,290
M-OUT-SS-18-55-BLCK	17.75"	black	3,831	4,615	4,986	5,140	5,406	5,616	6,246	7,975	8,080	8,290
M-OUT-SS-16-55-ALU	15.75"	aluminum	4,090	4,881	5,245	5,406	5,721	5,875	6,505	8,241	8,346	8,556
M-OUT-SS-18-55-ALU	17.75"	aluminum	4,090	4,881	5,245	5,406	5,721	5,875	6,505	8,241	8,346	8,556
<b>Outline Studio 170 cm / 67" Sofa</b>												
M-OUT-SS-16-67-BLCK	15.75"	black	4,090	4,671	5,091	5,350	5,511	6,295	7,240	8,500	8,661	9,291
M-OUT-SS-18-67-BLCK	17.75"	black	4,090	4,671	5,091	5,350	5,511	6,295	7,240	8,500	8,661	9,291
M-OUT-SS-16-67-ALU	15.75"	aluminum	4,356	4,986	5,350	5,616	5,770	6,561	7,506	8,766	8,920	9,550
M-OUT-SS-18-67-ALU	17.75"	aluminum	4,356	4,986	5,350	5,616	5,770	6,561	7,506	8,766	8,920	9,550
<b>Outline Studio 220 cm / 86.5" Sofa</b>												
M-OUT-SS-16-87-BLCK	15.75"	black	4,405	5,245	5,511	5,770	6,141	7,030	8,080	9,550	9,921	11,020
M-OUT-SS-18-87-BLCK	17.75"	black	4,405	5,245	5,511	5,770	6,141	7,030	8,080	9,550	9,921	11,020
M-OUT-SS-16-87-ALU	15.75"	aluminum	4,671	5,511	5,770	6,036	6,456	7,296	8,346	9,816	10,180	11,545
M-OUT-SS-18-87-ALU	17.75"	aluminum	4,671	5,511	5,770	6,036	6,456	7,296	8,346	9,816	10,180	11,545
<b>Outline Studio Chair</b>												
M-OUT-SC-16-BLCK	15.75"	black	2,620	3,096	3,516	3,565	3,775	4,090	4,300	5,140	5,350	5,721
M-OUT-SC-18-BLCK	17.75"	black	2,620	3,096	3,516	3,565	3,775	3,831	4,300	5,140	5,350	5,721
M-OUT-SC-16-ALU	15.75"	aluminum	2,886	3,355	3,775	3,831	4,041	4,146	4,566	5,406	5,616	5,980
M-OUT-SC-18-ALU	17.75"	aluminum	2,886	3,355	3,775	3,831	4,041	4,090	4,566	5,406	5,616	5,980

### HOW TO CONFIGURE

### ORDER CODE EXAMPLE:

Specify:

Outline Studio 140 cm Seat Height 15.75" w/black base in Ocean 80

- Step 1) Choose Variant + base color
- Step 2) Upholstery option
- Step 3) Upholstery color

Variant + base color: Outline Studio 140 cm Seat Height 15.75" w/black base  
 Upholstery option: Ocean  
 Upholstery Color: 80  
 Final Pattern No: MOUTSF2BLCKM16180

### Base Finish Options

- BLCK - Black
- ALU - Aluminum

### Upholstery Options

A	B	C	E	G	R	T	U	V	W
Mode (M2319) Ocean (M161)* Remix (M156)	Cameo (K1443) Canvas (M153) Clara (M154) Colline (M4516) Fiord (M155) Grain (M12659) Manner (M12665) Pebble Weave (M6374) ** Pecora (M6372) ** Prairie (K1925)* Steelcut (M149) Steelcut Trio (M139) Steelcut Quartet (M13042)	Chameleon (K2372) Color Field (K2226) Hallingdal (M146)	Acca (M12660) Aegean (K2074) Balder (M152) Beck (M6376) Divina (M150) Divina MD (M147) Divina Melange (M135) Ecriture (M10767) Hearth (M12664) Premiere (K2294) Twill Weave (M142) Vidar (M158)	Modern Tweed (K2155)	Easy Leather (M141)	Refine Leather (M136)	Endure Leather (M137)	Grace Leather (M12374)	Allure Leather (M12375)

\*Notes:  
 \*Ocean: Color 3, 21, 32, 50, 52, 80 & 601  
 \*\*Pebble Weave: Color 3, 7, 8, 11, 12, 21  
 \*\*Pecora: Color 6049, 6083, 6084, 6093, 60112  
 \*Prairie: All Additive Free (ADF) Colors  
 Illusion - Black, Blue, Caribou, Chocolate, Ciel, Dark Green, Dark Caramel, Grey, Light Grey, Mink, Matrine, Petrol, Stone, Taupe, Tile

# OUTLINE HIGHBACK SOFA SERIES

FOR MORE INFORMATION,  
EXPLORE BELOW

- ↗ [Product Fact Sheet](#)
- ↗ [Images](#)
- ↗ [Architect Files](#)
- ↗ [Assembly Instructions](#)
- ↗ [Product Declaration](#)
- ↗ [Product Configurator](#)

The Outline Sofa Family adds new perspectives to the classic Scandinavian design sofas of the 1960's, marrying the ideals of simplicity and function into one. With the design taking its name from its strong outline of a sofa, the Outline family is clean and elegant on the outside with a deep seat and soft cushioning on its inside.

## Highback 100 (Also available with SH: 45 cm / 17.7")

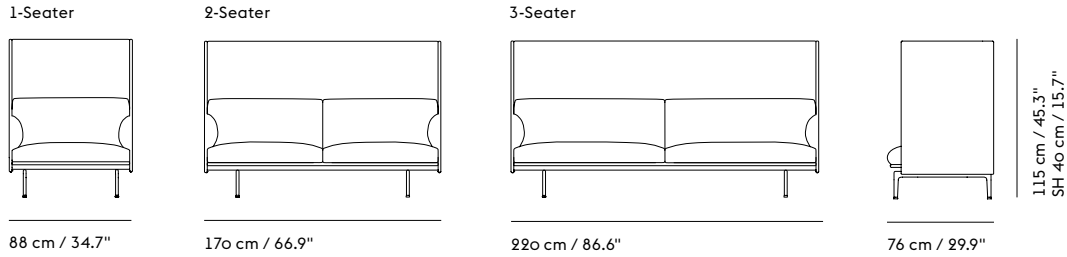

## Highback 120 (Also available with SH: 45 cm / 17.7")

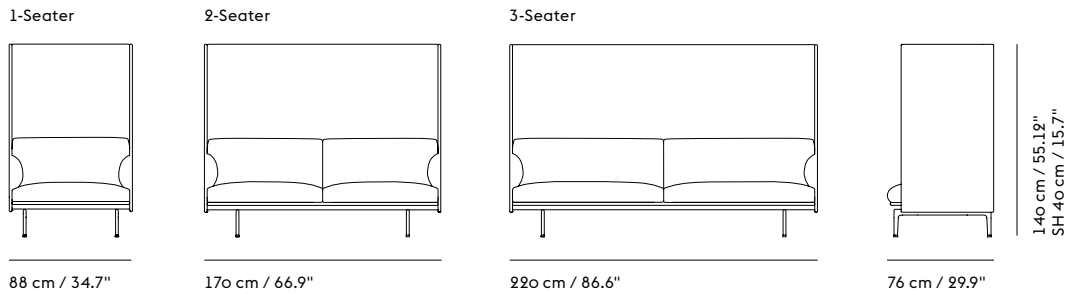

## Highback Work 100 (Also available with SH: 45 cm / 17.7")

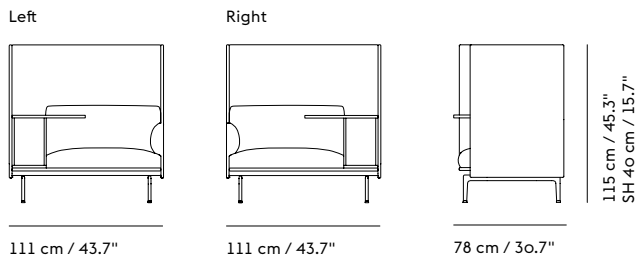

## Highback Work 120 (Also available with SH: 45 cm / 17.7")

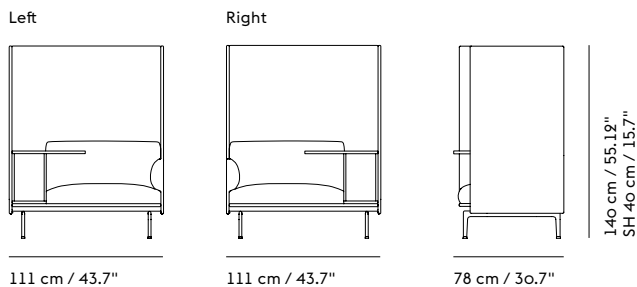

**Highback Cabin 100** (Also available with SH: 45 cm / 17.7")

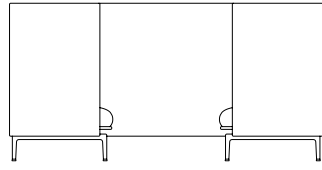

231 cm / 90.94"

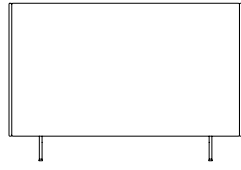

170 cm / 66.9"

115 cm / 45.3"  
SH 40 cm / 15.7"

**2-Seater**

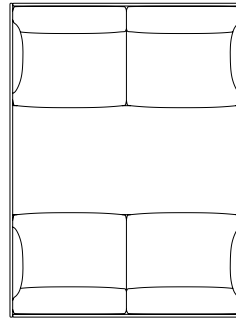

170 cm / 66.9"

**3-Seater**

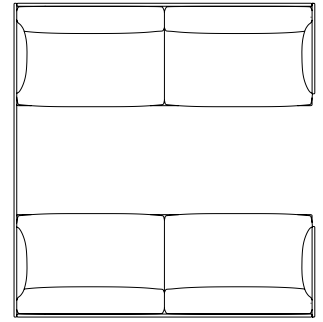

220 cm / 86.6"

**Highback Cabin 120** (Also available with SH: 45 cm / 17.7")

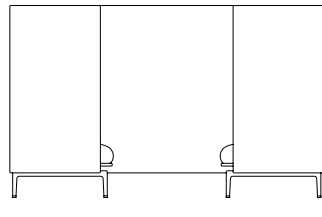

231 cm / 90.94"

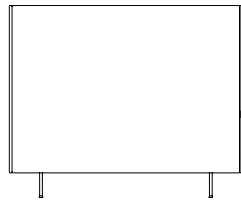

170 cm / 66.9"

140 cm / 55.12"  
SH 40 cm / 15.7"

**2-Seater**

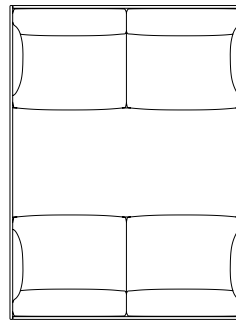

170 cm / 66.9"

**3-Seater**

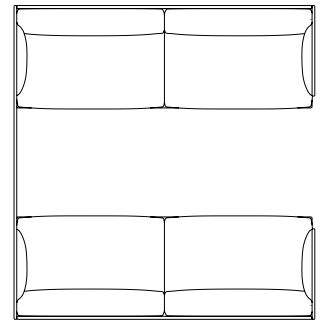

220 cm / 86.6"

**Highback Cabin 100 w/ Table—SH45 cm**

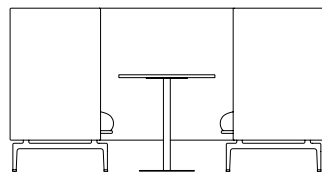

231 cm / 90.94"  
Table W 70cm / 27.56"

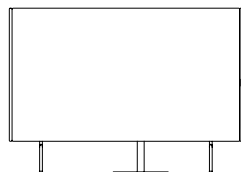

170 cm / 66.9"

120 cm / 47.3"  
SH 45 cm / 17.7"

Table H 71 cm / 27.95"

**2-Seater**

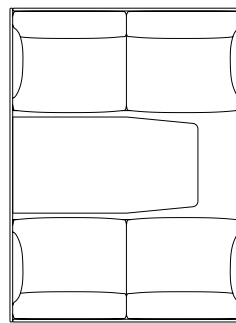

170 cm / 66.9"

**Highback Cabin 120 w/ Table—SH45 cm**

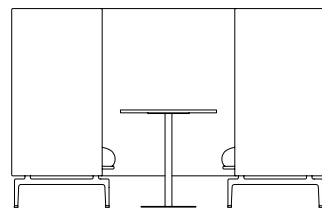

231 cm / 90.94"  
Table W 70cm / 27.56"

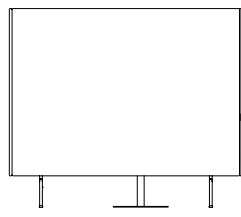

170 cm / 66.9"

145 cm / 57.09"  
SH 45 cm / 17.7"

Table H 71 cm / 27.95"

**2-Seater**

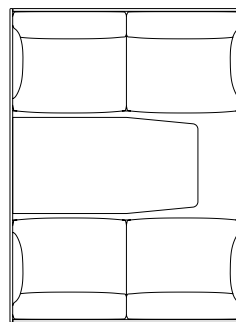

170 cm / 66.9"

# OUTLINE HIGHBACK SOFA 100 / 1-SEATER - BLACK BASE

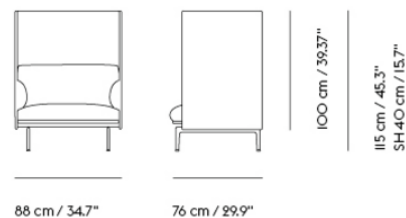

Shipper Colli	1
Gross Weight (kg)	63
Net Weight (kg)	54
Additional Information	Please note that the highback height for this product is 100 cm / 39.4"
Warranty Period	10 years

Pattern No.	Color	Contract Price	Lead Time
<b>Ready-To-Ship US Warehouse</b>			
MOUTHBSF116-BLCK-M156163	Remix I63/Black	USD 4,090.00	-
MOUTHBSF116-BLCK-K23401	Attire I/Black ***	USD 4,671.00	-
<b>Extras</b>			
MLEAKIT	Leather care set for Refine Leather	USD 27.00	-
MPWR0UT	Power Outlet - Black	USD 572.00	-

# OUTLINE HIGHBACK SOFA 100 / 1-SEATER - POLISHED ALUMINUM BASE

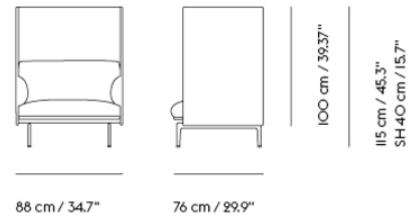

Shipper Colli	1
Gross Weight (kg)	63
Net Weight (kg)	54
Additional Information	Please note that the highback height for this product is 100 cm / 39.4"
Warranty Period	10 years

Pattern No.	Color	Contract Price	Lead Time
-------------	-------	----------------	-----------

**Ready-To-Ship US Warehouse**

MOUTHBSF116-ALU-M150984	Divina 984/Polished Aluminum	USD 5,616.00	-
-------------------------	------------------------------	--------------	---

**Extras**

MLEAKIT	Leather care set for Refine Leather	USD 27.00	-
MPWROUT	Power Outlet - Black	USD 572.00	-

# OUTLINE HIGHBACK SOFA 100 / 2-SEATER - BLACK BASE

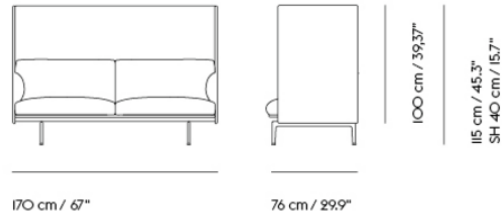

Shipper Colli	1
Gross Weight (kg)	71.6
Net Weight (kg)	71.6
Additional Information	Please note that the highback height for this product is 100 cm / 39.4"
Warranty Period	10 years

Pattern No.	Color	Contract Price	Lead Time
<b>Ready-To-Ship US Warehouse</b>			
MOUTHBSF216-BLCK-M156163	Remix 163/Black	USD 5,511.00	-
MOUTHBSF216-BLCK-K23401	Attire 1/Black ***	USD 6,141.00	-
<b>Extras</b>			
MLEAKIT	Leather care set for Refine Leather	USD 27.00	-
MPWR0UT	Power Outlet - Black	USD 572.00	-



# OUTLINE HIGHBACK SOFA 100 / 2-SEATER - POLISHED ALUMINUM BASE

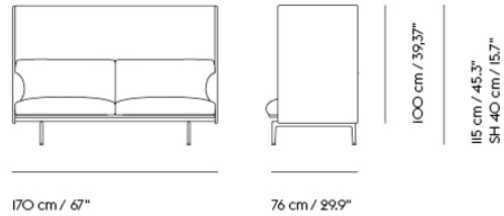

Shipper Colli	1
Gross Weight (kg)	85.84
Net Weight (kg)	71.6
Additional Information	Please note that the highback height for this product is 100 cm / 39.4"
Warranty Period	10 years

Pattern No.	Color	Contract Price	Lead Time
<b>Ready-To-Ship US Warehouse</b>			
MOUTHBSF216-ALU-M150984	Divina 984/Polished Aluminum	USD 7,296.00	-
<b>Extras</b>			
MLEAKIT	Leather care set for Refine Leather	USD 27.00	-
MPWROUT	Power Outlet - Black	USD 572.00	-

**OUTLINE HIGHBACK WORK 100 / LEFT -  
POLISHED ALUMINUM BASE**

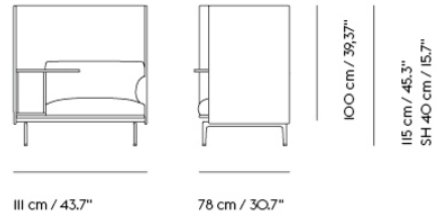

- Shipper Colli 1
- Gross Weight (kg) 83
- Net Weight (kg) 74
- Please note That this product features a table on the left-hand side when facing the product from the front.
- Warranty Period 5 years

Pattern No.	Color	Contract Price	Lead Time
<b>Ready-To-Ship US Warehouse</b>			
MOUTHBW16L-ALU-M150984	Divina 984/Polished Aluminum ***	USD 7,506.00	-
<b>Extras</b>			
MLEAKIT	Leather care set for Refine Leather	USD 27.00	-
MPWROUT	Power Outlet - Black	USD 572.00	-

**OUTLINE HIGHBACK WORK 100 / LEFT - BLACK BASE**

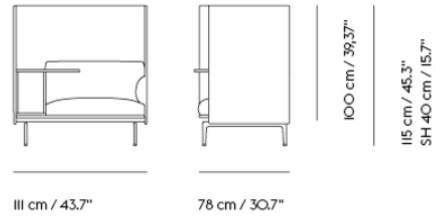

- Shipper Colli 1
- Gross Weight (kg) 83
- Net Weight (kg) 74
- Please note That this product features a table on the left-hand side when facing the product from the front.
- Warranty Period 5 years

Pattern No.	Color	Contract Price	Lead Time
-------------	-------	----------------	-----------

**Ready-To-Ship US Warehouse**

MOUTHBW16L-BLCK-M156163	Remix I63/Black	USD 5,980.00	-
-------------------------	-----------------	--------------	---

**Extras**

MLEAKIT	Leather care set for Refine Leather	USD 27.00	-
MPWROUT	Power Outlet - Black	USD 572.00	-

**OUTLINE HIGHBACK WORK 100 / RIGHT  
- BLACK BASE**

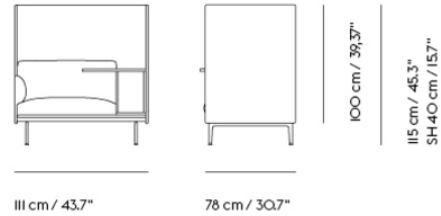

- Shipper Colli 1
- Gross Weight (kg) 83
- Net Weight (kg) 74
- Please note That this product features a table on the right-hand side when facing the product from the front.
- Warranty Period 5 years

Pattern No.	Color	Contract Price	Lead Time
-------------	-------	----------------	-----------

**Ready-To-Ship US  
Warehouse**

MOUTHBW16R-BLCK-M156163	Remix I63/Black	USD 5,980.00	-
-------------------------	-----------------	--------------	---

**Extras**

MLEAKIT	Leather care set for Refine Leather	USD 27.00	-
MPWROUT	Power Outlet - Black	USD 572.00	-

# OUTLINE HIGHBACK WORK 100 / RIGHT - POLISHED ALUMINUM BASE

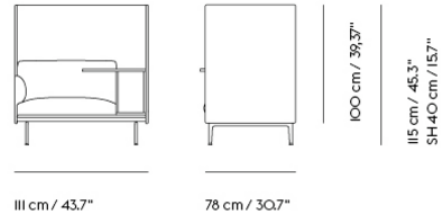

- Shipper Colli 1
- Gross Weight (kg) 83
- Net Weight (kg) 74
- Please note That this product features a table on the right-hand side when facing the product from the front.
- Warranty Period 5 years

Pattern No.	Color	Contract Price	Lead Time
-------------	-------	----------------	-----------

**Ready-To-Ship US Warehouse**

MOUTHBW16R-ALU-M150984	Divina 984/Polished Aluminum	USD 7,506.00	-
------------------------	------------------------------	--------------	---

**Extras**

MLEAKIT	Leather care set for Refine Leather	USD 27.00	-
MPWROUT	Power Outlet - Black	USD 572.00	-



**Highback Sofa 120 1-seater**  
 Shipper Colli: 1  
 Gross Weight (kg): 35  
 Net Weight (kg): 25  
 Warranty Period: 10 years

**Highback Sofa 120 2-seater**  
 Shipper Colli: 1  
 Gross Weight (kg): 54  
 Net Weight (kg): 38  
 Warranty Period: 10 years

**Highback Work 120**  
 Shipper Colli: 1  
 Gross Weight (kg): 38  
 Net Weight (kg): 28  
 Warranty Period: 5 years

**All Variants**

**HIGHBACK 3-SEATER 120CM**

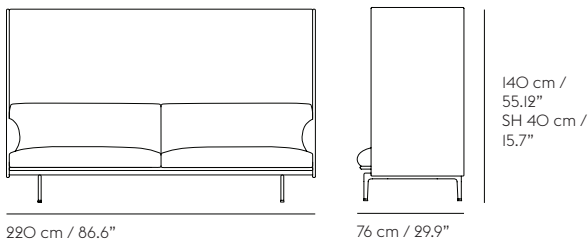

**HIGHBACK 3-SEATER 120CM - SH 45CM**

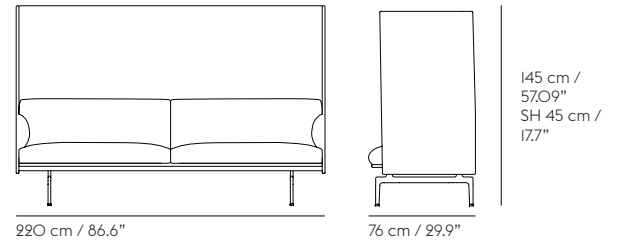

**HIGHBACK 2-SEATER 120CM**

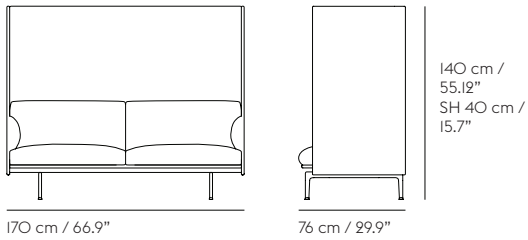

**HIGHBACK 2-SEATER 120CM - SH 45CM**

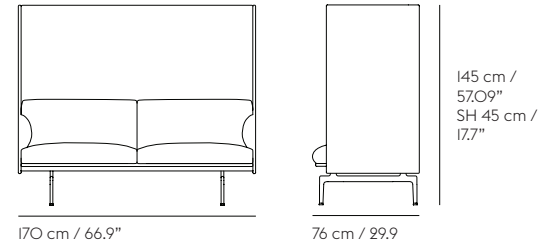

**HIGHBACK WORK 120CM - RIGHT**

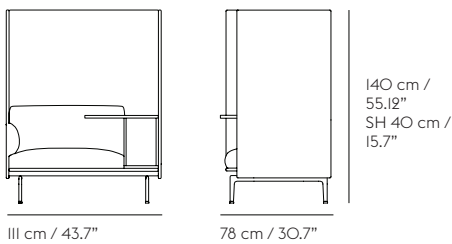

**HIGHBACK WORK 120CM - SH 45CM - RIGHT**

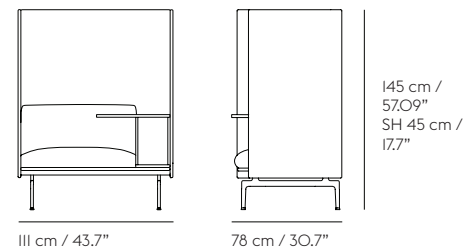

**HIGHBACK 1-SEATER 120CM**

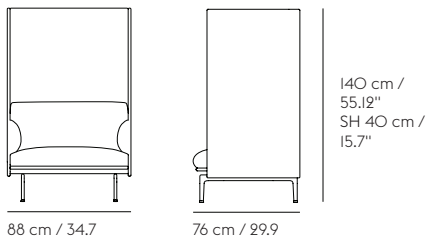

**HIGHBACK 1-SEATER 120CM - SH 45CM**

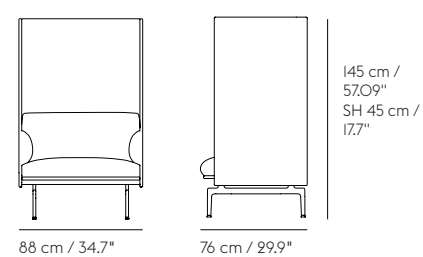

# OUTLINE HIGHBACK I-SEATER & WORK

## All Variants

				Upholstery Grades									
				COM			CIL			COL			
Pattern No.		A	B	C	E	G	R	T	U	V	W		
		Seat Height	Base Color										
Outline Highback 1-seater- 100cm	M-OUT-HBSF-1-16-BLCK	15.75"	black	4,090	4,671	5,091	5,350	5,511	6,295	7,240	8,500	8,661	8,920
	M-OUT-HBSF-1-18-BLCK	17.75"	black	4,090	4,671	5,091	5,350	5,511	6,295	7,240	8,500	8,661	8,920
	M-OUT-HBSF-1-16-ALU	15.75"	aluminum	4,356	4,986	5,350	5,616	5,770	6,561	7,506	8,766	8,920	9,186
	M-OUT-HBSF-1-18-ALU	17.75"	aluminum	4,356	4,986	5,350	5,616	5,770	6,561	7,506	8,766	8,920	9,186
Outline Highback 1-Seater - 120cm	M-OUT-HBSF-1-16-120-BLCK	15.75"	black	4,146	4,671	4,986	5,091	5,770	6,715	7,555	8,920	9,081	9,711
	M-OUT-HBSF-1-18-120-BLCK	17.75"	black	4,146	4,671	4,986	5,091	5,770	6,715	7,555	8,920	9,081	9,711
	M-OUT-HBSF-1-16-120-ALU	15.75"	aluminum	4,405	4,986	5,245	5,350	6,036	6,981	7,821	9,186	9,340	9,970
	M-OUT-HBSF-1-18-120-ALU	17.75"	aluminum	4,405	4,986	5,245	5,350	6,036	6,981	7,821	9,186	9,340	9,970
Outline Highback Work - Left - 100cm	M-OUT-HBW-16-L-BLCK	15.75"	black	5,980	6,561	7,030	7,240	7,506	9,186	10,446	11,545	11,545	12,070
	M-OUT-HBW-18-L-BLCK	17.75"	black	5,980	6,561	7,030	7,240	7,506	9,186	10,446	11,545	11,545	12,070
	M-OUT-HBW-16-L-ALU	15.75"	aluminum	6,246	6,820	7,296	7,506	7,765	9,445	11,020	12,070	12,070	12,595
	M-OUT-HBW-18-L-ALU	17.75"	aluminum	6,246	6,820	7,296	7,506	7,765	9,445	11,020	12,070	12,070	12,595
Outline Highback Work - Left - 120cm	M-OUT-HBW-16-L-120-BLCK	15.75"	black	6,246	6,820	7,191	7,296	8,451	9,081	10,075	12,070	12,070	12,595
	M-OUT-HBW-18-L-120-BLCK	17.75"	black	6,246	6,820	7,191	7,296	8,451	9,081	10,075	12,070	12,070	12,595
	M-OUT-HBW-16-L-120-ALU	15.75"	aluminum	6,505	7,086	7,450	7,555	8,710	9,340	10,341	12,070	12,595	13,120
	M-OUT-HBW-18-L-120-ALU	17.75"	aluminum	6,505	7,086	7,450	7,555	8,710	9,340	10,341	12,070	12,595	13,120
Outline Highback Work - Right - 100cm	M-OUT-HBW-16-R-BLCK	15.75"	black	5,980	6,561	7,030	7,240	7,506	9,186	10,446	11,545	11,545	12,070
	M-OUT-HBW-18-R-BLCK	17.75"	black	5,980	6,561	7,030	7,240	7,506	9,186	10,446	11,545	11,545	12,070
	M-OUT-HBW-16-R-ALU	15.75"	aluminum	6,246	6,820	7,296	7,506	7,765	9,445	11,020	12,070	12,070	12,595
	M-OUT-HBW-18-R-ALU	17.75"	aluminum	6,246	6,820	7,296	7,506	7,765	9,445	11,020	12,070	12,070	12,595
Outline Highback Work - Right - 120cm	M-OUT-HBW-16-R-120-BLCK	15.75"	black	6,246	6,715	7,191	7,296	8,451	9,081	10,075	12,070	12,070	12,595
	M-OUT-HBW-18-R-120-BLCK	17.75"	black	6,246	6,820	7,191	7,296	8,451	9,081	10,075	12,070	12,070	12,595
	M-OUT-HBW-16-R-120-ALU	15.75"	aluminum	6,505	7,086	7,450	7,555	8,710	9,340	10,341	12,070	12,595	13,120
	M-OUT-HBW-18-R-120-ALU	17.75"	aluminum	6,505	7,086	7,450	7,555	8,710	9,340	10,341	12,070	12,595	13,120

### HOW TO CONFIGURE

### ORDER CODE EXAMPLE:

Specify:

Outline Highback Sofa 2-seater H 15.75" in Ocean 80 w/black legs

SStep 1) Choose Variant + base color  
 Step 2) Upholstery option  
 Step 3) Upholstery color

Variant + base color      2-seater, 15.75" SH - black base      M-OUT-HBSF-2-16-BLCK  
 Upholstery option      Ocean      M161  
 Upholstery Color      80  
 Final Pattern No:      MOUTHBSF216BLCKM16180

### Base Finish Options

BLCK - Black  
 ALU - Aluminum

### Upholstery Options

A	B	C	E	G	R	T	U	V	W
Mode (M2319) Ocean (M161)* Remix (M156)	Cameo (K1443) Canvas (M153) Clara (M154) Fiord (M155) Grain (M12659) Manner (M12665) Pebble Weave (M6374)* Pecora (M6372)* Prairie (K1925) Steelcut (M149) Steelcut Trio (M139) Steelcut Quartet (M13042)	Chameleon (K2372) Color Field (K2226) Hallingdal (M146)	Acca (M12660) Aegean (K2074) Balder (M152) Beck (M6376) Divina (M150) Divina MD (M147) Divina Melange (M135) Ecriture (M10767) Hearth (M12664) Premiere (K2294) Twill Weave (M142) Vidar (M158)	Modern Tweed (K2155)**	Easy Leather (M141)	Refine Leather (M136)	Endure Leather (M137)	Grace Leather (M12374)	Allure Leather (M12375)

\*Notes:  
 \*Ocean: Color 3, 21, 32, 50, 52, 80 & 601  
 Pebble Weave: Color 3, 7, 8, 11, 12, 21  
 Pecora: Color 6049, 6083, 6084, 6093, 60112  
 \*Prairie: All Additive Free (ADF) Colors



3-seater - both heights:

Shipper Colli	1
Gross Weight (kg)	75
Net Weight (kg)	69
Warranty Period	10 years

2-seater - both heights:

Shipper Colli	1
Gross Weight (kg)	70
Net Weight (kg)	66
Warranty Period	10 years

1-seater - both heights:

Shipper Colli	1
Gross Weight (kg)	63
Net Weight (kg)	54
Warranty Period	10 years

Outline Highback Work - all versions:

Shipper Colli	1
Gross Weight (kg)	83
Net Weight (kg)	74
Warranty Period	5 years

All Variants

HIGHBACK 3-SEATER

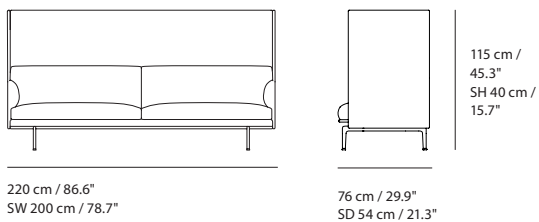

HIGHBACK 3-SEATER — SH 45 CM / 17.7"

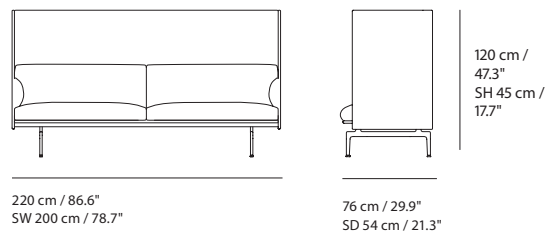

HIGHBACK 2-SEATER

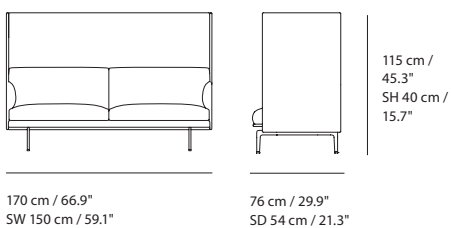

HIGHBACK 2-SEATER — SH 45 CM / 17.7"

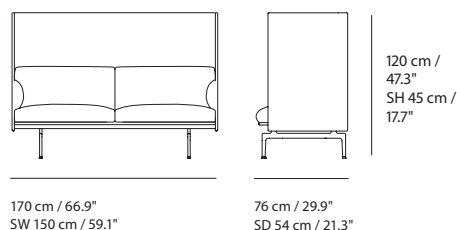

HIGHBACK WORK

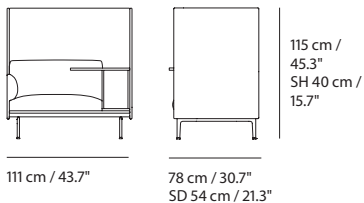

HIGHBACK WORK — SH 45 CM / 17.7"

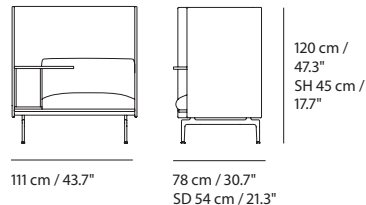

HIGHBACK 1-SEATER

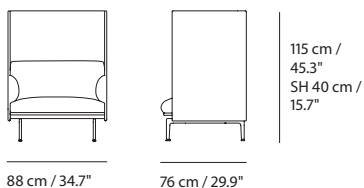

HIGHBACK 1-SEATER — SH 45 CM / 17.7"

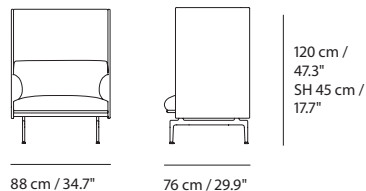



## All Variants

				Upholstery Grades									
				COM		CIL			COL				
Pattern No.				A	B	C	E	G	R	T	U	V	W
		Seat Height	Base Color/ hardware										
Outline Highback Sofa	M-OUT-HBSF-2-16-BLCK	15.75"	black	5,511	6,141	6,876	7,030	7,296	8,920	9,970	11,545	12,595	13,645
2-seater - 100cm	M-OUT-HBSF-2-18-BLCK	17.75"	black	5,511	6,141	6,876	7,030	7,296	8,920	9,970	11,545	12,595	13,645
	M-OUT-HBSF-2-16-ALU	15.75"	aluminum	5,770	6,456	7,191	7,296	7,555	9,186	10,236	11,545	12,595	14,170
	M-OUT-HBSF-2-18-ALU	17.75"	aluminum	5,770	6,456	7,191	7,296	7,555	9,186	10,236	11,545	12,595	14,170
Outline Highback Sofa	M-OUT-HBSF-2-16-120-BLCK	15.75"	black	5,875	6,715	7,030	7,240	8,241	9,711	11,545	13,645	13,645	14,695
2-seater - 120cm	M-OUT-HBSF-2-18-120-BLCK	17.75"	black	5,875	6,715	7,030	7,240	8,241	9,711	11,545	13,645	13,645	14,695
	M-OUT-HBSF-2-16-120-ALU	15.75"	aluminum	6,141	6,981	7,296	7,506	8,500	9,970	11,545	13,645	14,170	14,695
	M-OUT-HBSF-2-18-120-ALU	17.75"	aluminum	6,141	6,981	7,296	7,506	8,500	9,970	11,545	13,645	14,170	14,695
Outline Highback Sofa	M-OUT-HBSF-3-16-BLCK	15.75"	black	6,295	7,030	7,450	7,975	8,241	9,970	12,070	12,595	14,695	16,270
3-seater - 100cm	M-OUT-HBSF-3-18-BLCK	17.75"	black	6,295	7,030	7,450	7,975	8,241	9,970	12,070	12,595	14,695	16,270
	M-OUT-HBSF-3-16-ALU	15.75"	aluminum	6,561	7,296	7,716	8,241	8,500	10,236	12,070	13,120	14,695	16,270
	M-OUT-HBSF-3-18-ALU	17.75"	aluminum	6,561	7,296	7,716	8,241	8,500	10,236	12,070	13,120	14,695	16,270
Outline Highback Sofa	M-OUT-HBSF-3-16-120-BLCK	15.75"	black	6,715	7,555	8,080	8,290	9,501	11,545	13,120	15,745	16,270	17,845
3-seater - 120cm	M-OUT-HBSF-3-18-120-BLCK	17.75"	black	6,715	7,555	8,080	8,290	9,501	11,545	13,120	15,745	16,270	17,845
	M-OUT-HBSF-3-16-120-ALU	15.75"	aluminum	6,981	7,821	8,346	8,556	9,760	11,545	13,120	15,745	16,270	17,845
	M-OUT-HBSF-3-18-120-ALU	17.75"	aluminum	6,981	7,821	8,346	8,556	9,760	11,545	13,120	15,745	16,270	17,845

### HOW TO CONFIGURE

### ORDER CODE EXAMPLE:

Specify:

Outline Highback Sofa 2-seater H 15.75" in Ocean 80 w/black legs

SStep 1) Choose Variant + base color  
Step 2) Upholstery option  
Step 3) Upholstery color

Variant + base color 2-seater, 15.75" SH - black base  
Upholstery option Ocean  
Upholstery Color 80  
Final Pattern No: MOUTHBSF216BLCKM16180

### Base Finish Options

BLCK - Black  
ALU - Aluminum

### Upholstery Options

A	B	C	E	G	R	T	U	V	W
Mode (M2319)	Cameo (K1443)	Chameleon (K2372)	Acca (M12660)	Modern Tweed (K2155)**	Easy Leather (M141)	Refine Leather (M136)	Endure Leather (M137)	Grace Leather (M12374)	Allure Leather (M12375)
Ocean (M161)*	Canvas (M153)	Color Field (K2226)	Aegean (K2074)						
Remix (M156)	Clara (M154)	Hallingdal (M146)	Balder (M152)						
	Fiord (M155)		Beck (M6376)						
	Grain (M12659)		Divina (M150)						
	Manner (M12665)		Divina MD (M147)						
	Pebble Weave (M6374)*		Divina Melange (M135)						
	Pecora (M6372)*		Ecriture (M10767)						
	Prairie (K1925)		Hearth (M12664)						
	Steelcut (M149)		Premiere (K2294)						
	Steelcut Trio (M139)		Twill Weave (M142)						
	Steelcut Quartet (M13042)		Vidar (M158)						

\*Notes:  
\*Ocean: Color 3, 21, 32, 50, 52, 80 & 601  
Pebble Weave: Color 3, 7, 8, 11, 12, 21  
Pecora: Color 6049, 6083, 6084, 6093, 60112  
\*Prairie: All Additive Free (ADF) Colors  
\*\* Textiles are not available on the 120cm variants

# OUTLINE HIGHBACK CABIN



Highback Cabin 100 2-seater  
 Shipper Colli: 5  
 Gross Weight (kg): 69  
 Net Weight (kg): 52  
 Warranty Period: 10 years

Highback Cabin 100 3-seater  
 Shipper Colli: 5  
 Gross Weight (kg): 78  
 Net Weight (kg): 58  
 Warranty Period: 10 years

Highback Cabin 100 2-seater w/ table  
 Shipper Colli: 5  
 Gross Weight (kg): 98.5  
 Net Weight (kg): 75.5  
 Warranty Period: 10 years

Highback Cabin 120 2-seater  
 Shipper Colli: 5  
 Gross Weight (kg): 82  
 Net Weight (kg): 58.5  
 Warranty Period: 10 years

Highback Cabin 100 2-seater  
 Shipper Colli: 5  
 Gross Weight (kg): 92  
 Net Weight (kg): 65.5  
 Warranty Period: 10 years

Highback Cabin 100 2-seater w/ table  
 Shipper Colli: 5  
 Gross Weight (kg): 111.5  
 Net Weight (kg): 82  
 Warranty Period: 10 years

## All Variants

HIGHBACK CABIN 2-SEATER 100CM

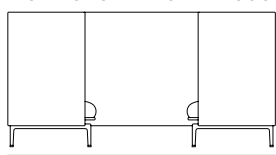

231 cm / 90.94"

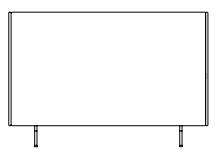

170 cm / 66.9"

115 cm / 45.3"  
 SH 40 cm / 15.7"

HIGHBACK CABIN 2-SEATER 100CM - SH 45CM

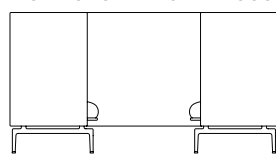

231 cm / 90.94"

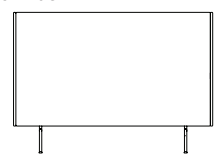

170 cm / 66.9"

120 cm / 47.3"  
 SH 45 cm / 17.7"

HIGHBACK CABIN 2-SEATER 120CM

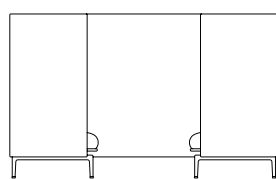

231 cm / 90.94"

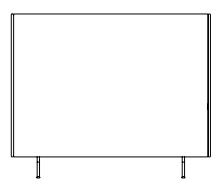

170 cm / 66.9"

140 cm / 55.12"  
 SH 40 cm / 15.7"

HIGHBACK CABIN 2-SEATER 120CM - SH 45CM

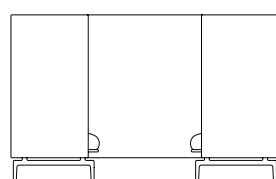

231 cm / 90.94"

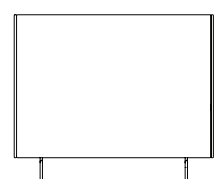

170 cm / 66.9"

145 cm / 57.09"  
 SH 45 cm / 17.7"

HIGHBACK CABIN 3-SEATER 100CM

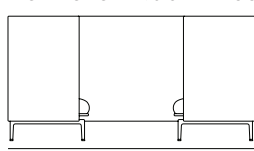

231 cm / 90.94"

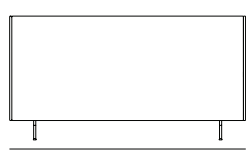

220 cm / 86.6"

115 cm / 45.3"  
 SH 40 cm / 15.7"

HIGHBACK CABIN 3-SEATER 100CM - SH 45CM

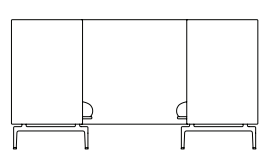

231 cm / 90.94"

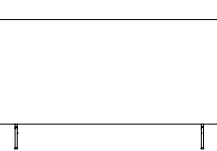

220 cm / 86.6"

120 cm / 47.3"  
 SH 45 cm / 17.7"

HIGHBACK CABIN 3-SEATER 120CM

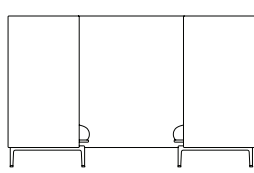

231 cm / 90.94"

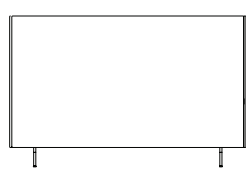

220 cm / 86.6"

140 cm / 55.12"  
 SH 40 cm / 15.7"

HIGHBACK CABIN 3-SEATER 120CM - SH 45CM

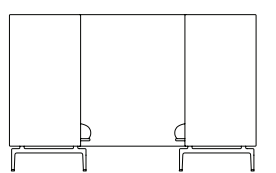

231 cm / 90.94"

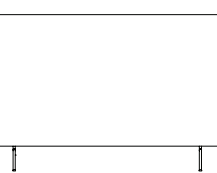

220 cm / 86.6"

145 cm / 57.09"  
 SH 45 cm / 17.7"

HIGHBACK CABIN 2-SEATER W/ TABLE 100CM - SH 45CM

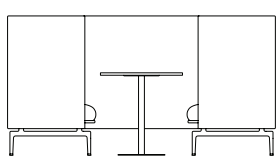

231 cm / 90.94"

Table W 70cm / 27.56"

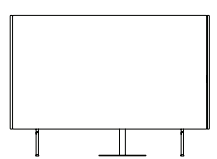

170 cm / 66.9"

120 cm / 47.3"  
 SH 45 cm / 17.7"  
 Table H 71 cm / 27.95"

HIGHBACK CABIN 2-SEATER 120CM W/ TABLE - SH 45CM

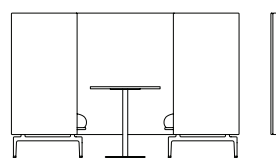

231 cm / 90.94"

Table W 70cm / 27.56"

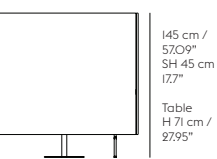

170 cm / 66.9"

145 cm / 57.09"  
 SH 45 cm / 17.7"  
 Table H 71 cm / 27.95"

# OUTLINE HIGHBACK CABIN

## All Variants

						Upholstery Grades									
						COM		CIL		COL					
Pattern No.						A	B	C	E	G	R	T	U	V	W
		Seat Height	Table option	Base/Hard-ware color											
Outline Highback Cabin	M-OUT-HBSC-2-16-N-BLCK	15.75"	without Table	black	11,020	13,120	13,645	14,170	16,795	18,895	21,520	25,195	25,720	28,345	
2-Seater - 100cm	M-OUT-HBSC-2-18-N-BLCK	17.75"	without Table	black	11,020	13,120	13,645	14,170	16,795	18,895	21,520	25,195	25,720	28,345	
	M-OUT-HBSC-2-18-T-BLCK	17.75"	With Table	black	12,595	14,170	15,220	15,220	16,795	19,945	22,570	26,770	27,820	29,395	
	M-OUT-HBSC-2-16-N-ALU	15.75"	without Table	aluminum	11,545	13,645	14,170	14,695	16,795	19,420	22,045	25,720	26,245	28,870	
	M-OUT-HBSC-2-18-N-ALU	17.75"	without Table	aluminum	11,545	13,645	14,170	14,695	16,795	19,420	22,045	25,720	26,245	28,870	
Outline Highback Cabin	M-OUT-HBSC-2-16-N-120-BLCK	15.75"	without Table	black	12,595	14,695	15,745	15,745	18,370	20,995	24,145	28,870	29,395	31,495	
2-seater - 120cm	M-OUT-HBSC-2-18-N-120-BLCK	17.75"	without Table	black	12,595	14,695	15,745	15,745	18,370	20,995	24,145	28,870	29,395	31,495	
	M-OUT-HBSC-2-18-T-120-BLCK	17.75"	With Table	black	14,170	15,745	16,795	17,320	19,420	22,570	25,720	30,445	30,970	33,595	
	M-OUT-HBSC-2-16-N-120-ALU	15.75"	without Table	aluminum	13,120	15,220	16,270	16,270	18,895	21,520	24,670	29,395	29,395	32,545	
	M-OUT-HBSC-2-18-N-120-ALU	17.75"	without Table	aluminum	13,120	15,220	16,270	16,270	18,895	21,520	24,670	29,395	29,395	32,545	
Outline Highback Cabin	M-OUT-HBSC-3-16-N-BLCK	15.75"	without table	black	12,595	14,695	15,220	15,745	18,895	21,520	24,670	29,395	29,395	33,070	
3-seater - 100cm	M-OUT-HBSC-3-18-N-BLCK	17.75"	without table	black	12,595	14,695	15,220	15,745	18,895	21,520	24,670	29,395	29,395	33,070	
	M-OUT-HBSC-3-16-N-ALU	15.75"	without table	aluminum	13,120	15,220	15,745	16,270	19,420	22,045	25,195	29,920	30,445	33,595	
	M-OUT-HBSC-3-18-N-ALU	17.75"	without table	aluminum	13,120	15,220	15,745	16,270	19,420	22,045	25,195	29,920	30,445	33,595	
Outline Highback Cabin	M-OUT-HBSC-3-16-120-N-BLCK	15.75"	without table	black	14,170	16,270	17,320	17,320	20,995	24,145	27,820	33,070	33,595	36,220	
3-seater - 120cm	M-OUT-HBSC-3-18-N-120-BLCK	17.75"	without table	black	14,170	16,270	17,320	17,320	20,995	24,145	27,820	33,070	33,595	36,220	
	M-OUT-HBSC-3-16-N-120-ALU	15.75"	without table	aluminum	14,695	16,795	17,845	17,845	20,995	24,670	28,345	33,595	33,595	36,745	
	M-OUT-HBSC-3-18-N-120-ALU	17.75"	without table	aluminum	14,695	16,795	17,845	17,845	20,995	24,670	28,345	33,595	33,595	36,745	

### HOW TO CONFIGURE

### ORDER CODE EXAMPLE:

Specify:

Outline Highback Cabin 2-seater - 100cm H 17.75" with Table in Balder 752 w/black legs

SStep 1) Choose Variant + base color  
 Step 2) Upholstery option  
 Step 3) Upholstery color

Variant + base color 2-seater, 15.75" SH, with Table - black base M-OUTH-HBSC-2-18-T-BLCK  
 Upholstery option Balder M152  
 Upholstery Color 752  
 Final Pattern No: MOUTHBSC218T120BLCKM152752

### Base Finish Options

BLCK - Black  
 ALU - Aluminum  
 \* Aluminum base not available for Cabin w/ Table

### Upholstery Options

A	B	C	E	G	R	T	U	V	W
Mode (M2319)	Cameo (K1443)	Chameleon (K2372)	Acca (M12660)	Modern Tweed (K2155)**	Easy Leather (M141)	Refine Leather (M136)	Endure Leather (M137)	Grace Leather (M12374)	Allure Leather (M12375)
Ocean (M161)*	Canvas (M153)	Color Field (K2226)	Aegean (K2074)						
Remix (M156)	Clara (M154)	Hallingdal (M146)	Balder (M152)						
	Fiord (M155)		Beck (M6376)						
	Grain (M12659)		Divina (M150)						
	Manner (M12665)		Divina MD (M147)						
	Pebble Weave (M6374)*		Divina Melange (M135)						
	Pecora (M6372)*		Ecriture (M10767)						
	Prairie (K1925)		Hearth (M12664)						
	Steelcut (M149)		Premiere (K2294)						
	Steelcut Trio (M139)		Twill Weave (M142)						
	Steelcut Quartet (M13042)		Vidar (M158)						

\*Notes:  
 \*Ocean: Color 3, 21, 32, 50, 52, 80 & 601  
 Pebble Weave: Color 3, 7, 8, 11, 12, 21  
 Pecora: Color 6049, 6083, 6084, 6093, 60112

# POWER OUTLET

FOR MORE INFORMATION,  
EXPLORE BELOW

- ↗ [Product Fact Sheet](#)
- ↗ [Images](#)
- ↗ [Assembly Instructions](#)

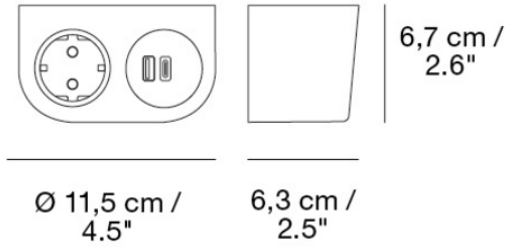

- Shipper Colli      1
- Gross Weight (kg)      0.41
- Net Weight (kg)      0.345
- Please note      The Power Outlet can be added to the following products: Outline Sofa Series and Rest Sofa Series.
- Warranty Period      5 years

Pattern No.	Color	Contract Price	Lead Time
<b>Ready-To-Ship US Warehouse</b>			
MPWROUT	Power Outlet - Black	USD 572.00	-

# REFLECT SIDEBOARD

FOR MORE INFORMATION,  
EXPLORE BELOW

- ↗ [Product Fact Sheet](#)
- ↗ [Images](#)
- ↗ [Architect Files](#)
- ↗ [Assembly Instructions](#)
- ↗ [Product Declaration](#)

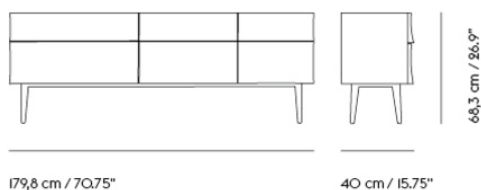

**Shipper Colli** 1  
**Gross Weight (kg)** 147.6  
**Net Weight (kg)** 71  
**Please note** This product includes 2 drawers and 1 shelf. No additional shelves or drawers can be added.  
**Warranty Period** 5 years

Pattern No.	Color	Contract Price	Lead Time
<b>Ready-To-Ship US Warehouse</b>			
MRFLSBLG-BLCK	Black	USD 4,671.00	-
MRFLSBLG-OAK	Oiled Oak	USD 4,671.00	-

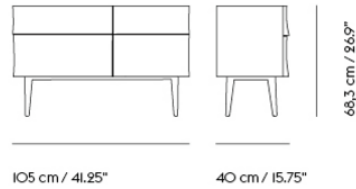

- Shipper Colli 1
- Gross Weight (kg) 92
- Net Weight (kg) 50
- Please note This product includes 2 shelves. No additional shelves can be added.
- Warranty Period 5 years

Pattern No.	Color	Contract Price	Lead Time
<b>Ready-To-Ship EU Warehouse</b>			
MRFLSBSM-BLCK	Black	USD 3,145.00	-
MRFLSBSM-OAK	Oiled Oak	USD 3,145.00	-



# RELATE SIDE TABLE

FOR MORE INFORMATION,  
EXPLORE BELOW

- ↗ [Product Fact Sheet](#)
- ↗ [Images](#)
- ↗ [Architect Files](#)
- ↗ [Assembly Instructions](#)
- ↗ [Product Declaration](#)

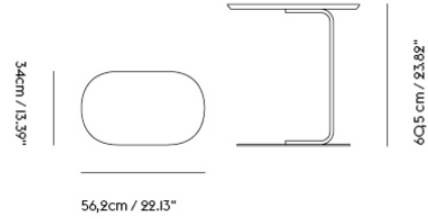

**Shipper Colli** 1  
**Gross Weight (kg)** 12.577  
**Net Weight (kg)** 11.5  
**Warranty Period** 5 Years

Pattern No.	Color	Contract Price	Lead Time
<b>Ready-To-Ship US Warehouse</b>			
MRELST23-OAK-BLCK	Oak Veneer/Black ***	USD 629.00	-
MRELST23-OAK-OWHT	Oak Veneer/Off-White ***	USD 629.00	-
MRELST23-BLCK-BLCK	Black	USD 576.00	-
MRELST23-BUGY-BUGY	Blue-Grey	USD 576.00	-
MRELST23-DKGN-DKGN	Dark Green	USD 576.00	-
MRELST23-OWHT-OWHT	Off-White	USD 576.00	-
MRELST23-SOAK-OWHT	Solid Oak/Off-White	USD 629.00	-
MRELST23-SMOAK-BLCK	Solid Smoked Oak/Black	USD 629.00	-

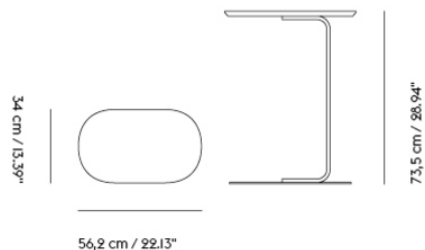

Shipper Colli	1
Gross Weight (kg)	15.65
Net Weight (kg)	14.2
Warranty Period	5 Years

Pattern No.	Color	Contract Price	Lead Time
<b>Ready-To-Ship US Warehouse</b>			
MRELST29-OAK-BLCK	Oak Laminate/Black	USD 667.00	-
MRELST29-OAK-OWHT	Oak Veneer/Off-White ***	USD 667.00	-
MRELST29-BLCK-BLCK	Black	USD 614.00	-
MRELST29-BUGY-BUGY	Blue-Grey	USD 614.00	-
MRELST29-DKGN-DKGN	Dark Green	USD 614.00	-
MRELST29-OWHT-OWHT	Off-White	USD 614.00	-
MRELST29-SOAK-OWHT	Solid Oak/Off-White	USD 667.00	-
MRELST29-SMOAK-BLCK	Solid Smoked Oak/Black	USD 667.00	-

# REST SOFA SERIES

FOR MORE INFORMATION,  
EXPLORE BELOW

- ↗ [Product Fact Sheet](#)
- ↗ [Images](#)
- ↗ [Architect Files](#)
- ↗ [Assembly Instructions](#)
- ↗ [Product Declaration](#)
- ↗ [Product Configurator](#)

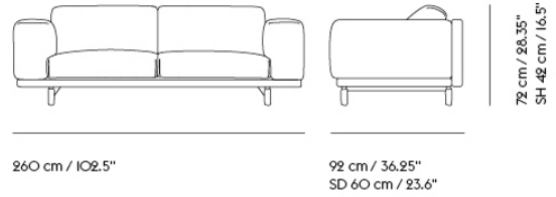

**Shipper Colli** |  
**Gross Weight (kg)** 109  
**Net Weight (kg)** 104  
**Warranty Period** 10 years

Pattern No.	Color	Contract Price	Lead Time
<b>Ready-To-Ship US Warehouse</b>			
MRSTSF3-M139133	Steelcut Trio 133/Oak ***	USD 6,036.00	-
<b>Extras</b>			
MLEGSRSF-GREY	Sofa Legs for Rest Sofa 2 and 3-Seater - Grey	USD 198.00	-
MPWRROUT	Power Outlet - Black	USD 572.00	-

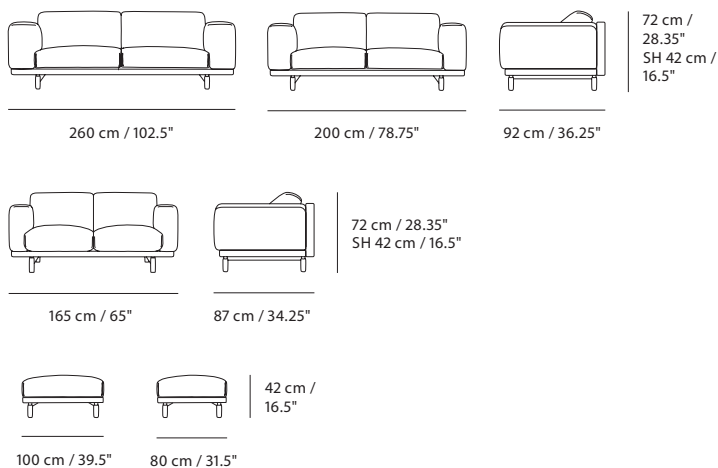

**Rest Studio:**  
 Shipper Colli 1  
 Gross Weight (kg) 75  
 Net Weight (kg) 70  
 Warranty Period 10 years

**Rest Pouf:**  
 Shipper Colli 1  
 Gross Weight (kg) 23  
 Net Weight (kg) 20  
 Warranty Period 10 years

### All Variants

		Upholstery Grades			
		A	COM B	CIL C	E
Pattern No.					
2-seater w/ oak legs	M-RSTSF-2	4,615	5,140	5,406	6,036
3-seater w/ oak legs	M-RSTSF-3	5,140	6,036	6,295	7,240
Pouf	M-RSTP	1,570	1,675	1,836	2,305

### HOW TO CONFIGURE

Specify:

- Step 1) Choose Variant
- Step 2) Textile
- Step 3) Textile color

### ORDER CODE EXAMPLE:

Rest 2-seater Sofa in Remix 133

Variant	Rest 2-seater sofa	MRSTSF2
Textile	Remix	M156
Textile Color	133	33
Final Pattern No:	MRSTSF2M156133	

### Upholstery Options

A	B	C	E
Remix (M156)	Canvas (M153)	Hallingdal (M146)	Acca (M12660)
Vancouver (M148)	Clara (M154)		Balder (M152)
Wooly (M159)	Fiord (M155)		Beck (M6376)
Ocean (161)*	Grain (M12659)		Clay (M2449)
	Manner (M12665)		Divina (M150)
	Steelcut (M149)		Divina MD (M135)
	Steelcut Trio (M139)		Divina Melange (M147)
			Ecriture (M10767)
			Hearth (M12664)
			Twill Weave (M142)
			Vidar (M158)

\*Notes:  
 \*Ocean: Color 3, 21, 32, 50, 52, 80 & 601

# SOFT TABLE SERIES

FOR MORE INFORMATION,  
EXPLORE BELOW

- ↗ [Product Fact Sheet](#)
- ↗ [Images](#)
- ↗ [Assembly Instructions](#)
- ↗ [Architect Files](#)
- ↗ [Product Declaration](#)

# SOFT SIDE TABLE / Ø 41 H: 40 CM / Ø 16.1" H: 15.7"

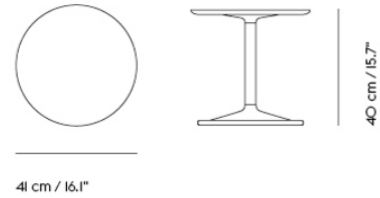

Shipper Colli	2
Gross Weight (kg)	8.873
Net Weight (kg)	7.158
Warranty period	10 years

Pattern No.	Color	Contract Price	Lead Time
<b>Ready-To-Ship US Warehouse</b>			
MSFTSTO1616L-DGRN-DGRN	Dusty Green Laminate/Dusty Green ***	USD 541.00	-
MSFTSTO1616O-OWHT-OWHT	Off-White Linoleum/Off-White ***	USD 541.00	-
MSFTSTO1616L-ORNG-ORNG	Orange Laminate/Orange	USD 541.00	-
MSFTSTO1616N-BLCK-BLCK	Black Nanolaminate/Black	USD 541.00	-
MSFTSTO1616O-GREY-GREY	Grey Linoleum/Grey	USD 541.00	-
MSFTSTO1616W-OWHT-SOAK	Oiled Oak/Off-White ***	USD 629.00	-
MSFTSTO1616O-GREY-SOAK	Solid Oak/Grey	USD 629.00	-
MSFTSTO1616W-BLCK-SMOAK	Solid Smoked Oak/Black	USD 629.00	-
<b>Ready-To-Ship EU Warehouse</b>			
MSFTSTO1616L-BGRN-BGRN	Beige Green Laminate/Beige Green	USD 541.00	-



# SOFT SIDE TABLE / Ø 41 H: 48 CM / Ø 16.1" H: 18.9"

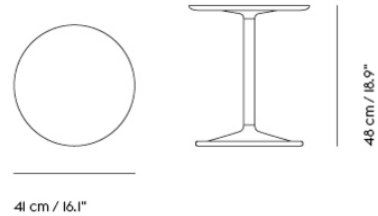

Shipper Colli	2
Gross Weight (kg)	8.873
Net Weight (kg)	7.158
Warranty period	10 years

Pattern No.	Color	Contract Price	Lead Time
<b>Ready-To-Ship US Warehouse</b>			
MSFTSTO1619L-DGRN-DGRN	Dusty Green Laminate/Dusty Green ***	USD 541.00	-
MSFTSTO1619L-ORNG-ORNG	Orange Laminate/Orange	USD 541.00	-
MSFTSTO1619N-BLCK-BLCK	Black Nanolaminate/Black	USD 541.00	-
MSFTSTO1619O-GREY-GREY	Grey Linoleum/Grey	USD 541.00	-
MSFTSTO1619O-OWHT-OWHT	Off-White Linoleum/Off-White ***	USD 541.00	-
MSFTSTO1619W-OWHT-SOAK	Oiled Oak/Off-White ***	USD 629.00	-
MSFTSTO1619W-BLCK-SMOAK	Oiled Smoked Oak/Black	USD 629.00	-
MSFTSTO1619O-GREY-SOAK	Solid Oak/Grey	USD 629.00	-
<b>Ready-To-Ship EU Warehouse</b>			
MSFTSTO1619L-BGRN-BGRN	Beige Green Laminate/Beige Green	USD 541.00	-

# SOFT SIDE TABLE / Ø 48 H: 40 CM / Ø 18.9" H: 15.7"

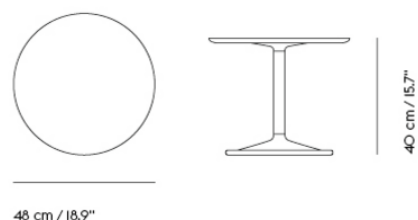

Shipper Colli	2
Gross Weight (kg)	10.776
Net Weight (kg)	8.506
Warranty period	10 years

Pattern No.	Color	Contract Price	Lead Time
<b>Ready-To-Ship US Warehouse</b>			
MSFTSTO1916L-DGRN-DGRN	Dusty Green Laminate/Dusty Green ***	USD 629.00	-
MSFTSTO1916L-ORNG-ORNG	Orange Laminate/Orange	USD 629.00	-
MSFTSTO1916N-BLCK-BLCK	Black Nanolaminate/Black	USD 629.00	-
MSFTSTO1916O-GREY-GREY	Grey Linoleum/Grey	USD 629.00	-
MSFTSTO1916O-OWHT-OWHT	Off-White Linoleum/Off-White ***	USD 629.00	-
MSFTSTO1916W-OWHT-SOAK	Oiled Oak/Off-White ***	USD 719.00	-
MSFTSTO1916W-BLCK-SMOAK	Oiled Smoked Oak/Black	USD 719.00	-
MSFTSTO1916O-GREY-SOAK	Solid Oak/Grey	USD 719.00	-
<b>Ready-To-Ship EU Warehouse</b>			
MSFTSTO1916L-BGRN-BGRN	Beige Green Laminate/Beige Green	USD 629.00	-

**SOFT SIDE TABLE / Ø 48 H: 48 CM / Ø 18.9" H: 18.9"**

400

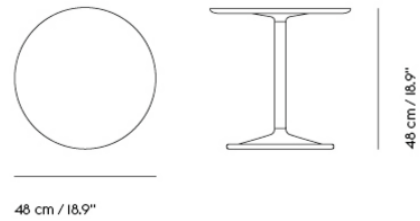

Shipper Colli	2
Gross Weight (kg)	10.776
Net Weight (kg)	8.506
Warranty period	10 years

Pattern No.	Color	Contract Price	Lead Time
<b>Ready-To-Ship US Warehouse</b>			
MSFTSTO1919L-DGRN-DGRN	Dusty Green Laminate/Dusty Green ***	USD 629.00	-
MSFTSTO1919L-ORNG-ORNG	Orange Laminate/Orange	USD 629.00	-
MSFTSTO1919N-BLCK-BLCK	Black Nanolaminate/Black	USD 629.00	-
MSFTSTO1919O-GREY-GREY	Grey Linoleum/Grey	USD 629.00	-
MSFTSTO1919O-OWHT-OWHT	Off-White Linoleum/Off-White ***	USD 629.00	-
MSFTSTO1919W-OWHT-SOAK	Oiled Oak/Off-White ***	USD 719.00	-
MSFTSTO1919W-BLCK-SMOAK	Oiled Smoked Oak/Black	USD 719.00	-
MSFTSTO1919O-GREY-SOAK	Solid Oak/Grey	USD 719.00	-
<b>Ready-To-Ship EU Warehouse</b>			
MSFTSTO1919L-BGRN-BGRN	Beige Green Laminate/Beige Green	USD 629.00	-

# SOFT SIDE TABLE / 45 X 45 H: 40 CM / 17.7 X 17.7 H: 15.7"

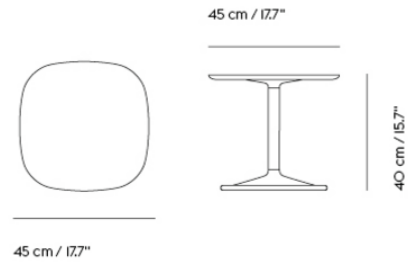

Shipper Colli	2
Gross Weight (kg)	8.939
Net Weight (kg)	7.649
Warranty period	10 years

Pattern No.	Color	Contract Price	Lead Time
<b>Ready-To-Ship US Warehouse</b>			
MSFTSTR171716L-DGRN-DGRN	Dusty Green Laminate/Dusty Green ***	USD 629.00	-
MSFTSTR171716L-ORNG-ORNG	Orange Laminate/Orange ***	USD 629.00	-
MSFTSTR171716N-BLCK-BLCK	Black Nanolaminate/Black ***	USD 629.00	-
MSFTSTR171716O-OWHT-OWHT	Off-White Linoleum/Off-White ***	USD 629.00	-
MSFTSTR171716W-OWHT-SOAK	Oiled Oak/Off-White ***	USD 719.00	-
MSFTSTR171716W-BLCK-SMOAK	Oiled Smoked Oak/Black ***	USD 719.00	-

# SOFT SIDE TABLE / 45 X 45 H: 48 CM / 17.7 X 17.7 H: 18.9"

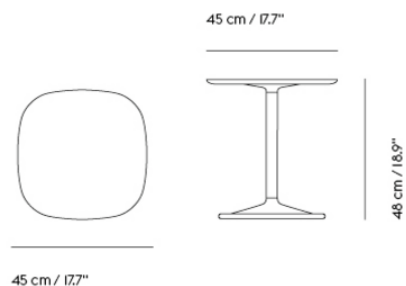

Shipper Colli	2
Gross Weight (kg)	9.02
Net Weight (kg)	7.73
Warranty period	10 years

Pattern No.	Color	Contract Price	Lead Time
<b>Ready-To-Ship US Warehouse</b>			
MSFTSTR171719L-DGRN-DGRN	Dusty Green Laminate/Dusty Green ***	USD 629.00	-
MSFTSTR171719L-ORNG-ORNG	Orange Laminate/Orange ***	USD 629.00	-
MSFTSTR171719N-BLCK-BLCK	Black Nanolaminate/Black ***	USD 629.00	-
MSFTSTR171719O-OWHT-OWHT	Off-White Linoleum/Off-White ***	USD 629.00	-
MSFTSTR171719W-OWHT-SOAK	Oiled Oak/Off-White ***	USD 719.00	-
MSFTSTR171719W-BLCK-SMOAK	Oiled Smoked Oak/Black ***	USD 719.00	-

# SOFT COFFEE TABLE / Ø 75 H: 42 CM / Ø 29.5 H: 16.5"

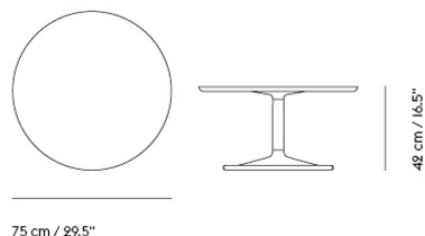

Shipper Colli	3
Gross Weight (kg)	20.923
Net Weight (kg)	16.517
Warranty period	5 years

Pattern No.	Color	Contract Price	Lead Time
<b>Ready-To-Ship US Warehouse</b>			
MSFTCTO3016N-BLCK-BLCK	Black Nanolaminate/Black	USD 1,311.00	-
MSFTCTO3016O-GREY-GREY	Grey Linoleum/Grey	USD 1,206.00	-
MSFTCTO3016W-BLCK-DOAK	Dark Oiled Oak/Black	USD 1,360.00	-
MSFTCTO3016W-GREY-SOAK	Solid Oak/Grey	USD 1,360.00	-
<b>Ready-To-Ship EU Warehouse</b>			
MSFTCTO3016L-BGRN-BGRN	Beige Green Laminate/Beige Green	USD 1,206.00	-

# SOFT COFFEE TABLE / SOFT COFFEE TABLE / Ø 95 H: 42 CM / Ø 37.4 H: 16.5"

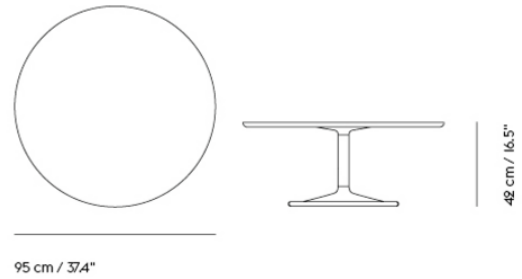

Shipper Colli	3
Gross Weight (kg)	27.823
Net Weight (kg)	22.467
Warranty period	5 years

Pattern No.	Color	Contract Price	Lead Time
<b>Ready-To-Ship US Warehouse</b>			
MSFTCT03716N-BLCK-BLCK	Black Nanolaminate/Black	USD 1,416.00	-
MSFTCT03716O-GREY-GREY	Grey Linoleum/Grey	USD 1,360.00	-
MSFTCT03716W-BLCK-DOAK	Dark Oiled Oak/Black	USD 1,465.00	-
MSFTCT03716W-GREY-SOAK	Solid Oak/Grey	USD 1,465.00	-
<b>Ready-To-Ship EU Warehouse</b>			
MSFTCT03716L-BGRN-BGRN	Beige Green Laminate/Beige Green	USD 1,360.00	-

**SOFT COFFEE TABLE / 70 X 70 H: 42 CM /  
27.6 X 27.6 H: 16.5"**

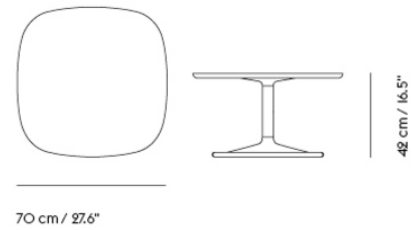

Shipper Colli	3
Gross Weight (kg)	21.823
Net Weight (kg)	17.417
Warranty period	5 years

Pattern No.	Color	Contract Price	Lead Time
<b>Ready-To-Ship US Warehouse</b>			
MSFTCTR303016N-BLCK-BLCK	Black Nanolaminate/Black	USD 1,311.00	-
MSFTCTR303016O-GREY-GREY	Grey Linoleum/Grey	USD 1,206.00	-
MSFTCTR303016W-BLCK-DOAK	Dark Oiled Oak/Black	USD 1,360.00	-
MSFTCTR303016W-GREY-SOAK	Solid Oak/Grey	USD 1,360.00	-
<b>Ready-To-Ship EU Warehouse</b>			
MSFTCTR303016L-BGRN-BGRN	Beige Green Laminate/Beige Green	USD 1,206.00	-



**SOFT CAFÉ TABLE / 70 X 70 H: 73 CM /  
27.6 X 27.6 H: 28.7"**

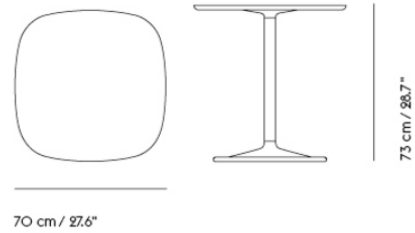

Shipper Colli 3  
 Gross Weight (kg) 22.3  
 Net Weight (kg) 17.854  
 Warranty period 5 years

Pattern No.	Color	Contract Price	Lead Time
<b>Ready-To-Ship US Warehouse</b>			
MSFTCETR282829N-BLCK-BLCK	Black Nanolaminate/Black	USD 1,360.00	-
MSFTCETR282829O-GREY-GREY	Grey Linoleum/Grey	USD 1,311.00	-
MSFTCETR282829W-BLCK-DOAK	Dark Oiled Oak/Black	USD 1,416.00	-
MSFTCETR282829W-GREY-SOAK	Solid Oak/Grey	USD 1,416.00	-
<b>Ready-To-Ship EU Warehouse</b>			
MSFTCETR282829L-BGRN-BGRN	Beige Green Laminate/Beige Green	USD 1,311.00	-

**SOFT CAFÉ TABLE / 70 X 70 H: 95 CM /  
27.6 X 27.6" H: 37.4"**

407

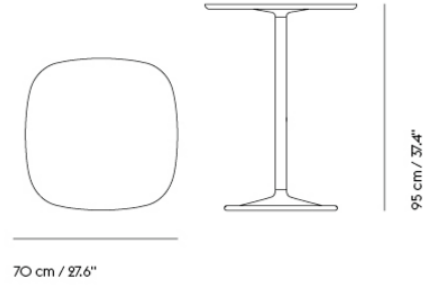

Shipper Colli 3  
Gross Weight (kg) 22.623  
Net Weight (kg) 18.147  
Warranty period 5 years

Pattern No.	Color	Contract Price	Lead Time
<b>Ready-To-Ship US Warehouse</b>			
MSFTCETR282837N-BLCK-BLCK	Black Nanolaminate/Black	USD 1,416.00	-
MSFTCETR282837O-GREY-GREY	Grey Linoleum/Grey	USD 1,360.00	-
MSFTCETR282837W-BLCK-DOAK	Dark Oiled Oak/Black	USD 1,465.00	-
MSFTCETR282837W-GREY-SOAK	Solid Oak/Grey	USD 1,465.00	-
<b>Ready-To-Ship EU Warehouse</b>			
MSFTCETR282837L-BGRN-BGRN	Beige Green Laminate/Beige Green	USD 1,360.00	-

# SOFT CAFÉ TABLE / 70 X 70 H: 105 CM / 27.6 X 27.6" H: 41.3"

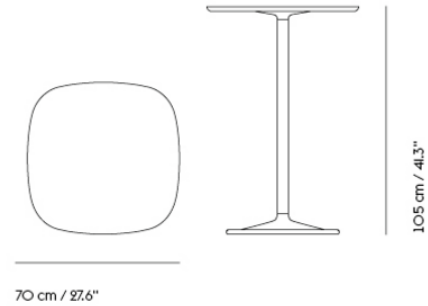

Shipper Colli	3
Gross Weight (kg)	22.777
Net Weight (kg)	18.291
Warranty period	5 years

Pattern No.	Color	Contract Price	Lead Time
<b>Ready-To-Ship US Warehouse</b>			
MSFTCETR282841N-BLCK-BLCK	Black Nanolaminate/Black	USD 1,416.00	-
MSFTCETR282841O-GREY-GREY	Grey Linoleum/Grey	USD 1,360.00	-
MSFTCETR282841W-BLCK-DOAK	Dark Oiled Oak/Black	USD 1,465.00	-
MSFTCETR282841W-GREY-SOAK	Solid Oak/Grey	USD 1,465.00	-
<b>Ready-To-Ship EU Warehouse</b>			
MSFTCETR282841L-BGRN-BGRN	Beige Green Laminate/Beige Green	USD 1,360.00	-

**SOFT CAFÉ TABLE / Ø 75 H: 73 CM / Ø 29.5 H: 28.7"**

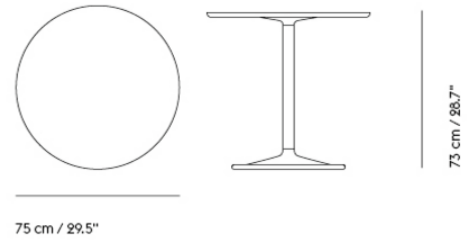

**Shipper Colli** 3  
**Gross Weight (kg)** 21.4  
**Net Weight (kg)** 16.954  
**Warranty period** 5 years

Pattern No.	Color	Contract Price	Lead Time
<b>Ready-To-Ship US Warehouse</b>			
MSFTCETO2829N-BLCK-BLCK	Black Nanolaminate/Black	USD 1,360.00	-
MSFTCETO2829O-GREY-GREY	Grey Linoleum/Grey	USD 1,311.00	-
MSFTCETO2829W-BLCK-DOAK	Dark Oiled Oak/Black	USD 1,416.00	-
MSFTCETO2829W-GREY-SOAK	Solid Oak/Grey	USD 1,416.00	-
<b>Ready-To-Ship EU Warehouse</b>			
MSFTCETO2829L-BGRN-BGRN	Beige Green Laminate/Beige Green	USD 1,311.00	-

**SOFT CAFÉ TABLE / Ø 75 CM H: 95 CM / Ø 29.5" H: 37.4"**

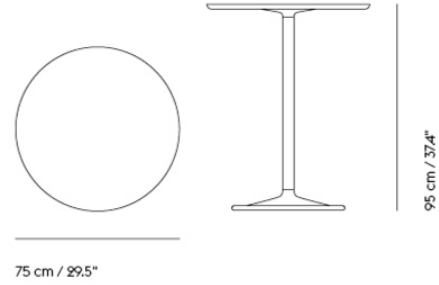

**Shipper Colli** 3  
**Gross Weight (kg)** 21.723  
**Net Weight (kg)** 17.247  
**Warranty period** 5 years

Pattern No.	Color	Contract Price	Lead Time
<b>Ready-To-Ship US Warehouse</b>			
MSFTCETO2837N-BLCK-BLCK	Black Nanolaminate/Black	USD 1,416.00	-
MSFTCETO2837O-GREY-GREY	Grey Linoleum/Grey	USD 1,360.00	-
MSFTCETO2837W-BLCK-DOAK	Dark Oiled Oak/Black	USD 1,465.00	-
MSFTCETO2837W-GREY-SOAK	Solid Oak/Grey	USD 1,465.00	-
<b>Ready-To-Ship EU Warehouse</b>			
MSFTCETO2837L-BGRN-BGRN	Beige Green Laminate/Beige Green	USD 1,360.00	-

# SOFT CAFÉ TABLE / Ø 75 H: 105 CM / Ø 29.5" H: 41.3"

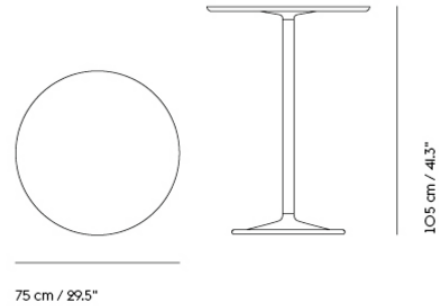

Shipper Colli	3
Gross Weight (kg)	21.877
Net Weight (kg)	17.391
Warranty period	5 years

Pattern No.	Color	Contract Price	Lead Time
<b>Ready-To-Ship US Warehouse</b>			
MSFTCETO2841N-BLCK-BLCK	Black Nanolaminate/Black	USD 1,416.00	-
MSFTCETO2841O-GREY-GREY	Grey Linoleum/Grey	USD 1,360.00	-
MSFTCETO2841W-BLCK-DOAK	Dark Oiled Oak/Black	USD 1,465.00	-
MSFTCETO2841W-GREY-SOAK	Solid Oak/Grey	USD 1,465.00	-
<b>Ready-To-Ship EU Warehouse</b>			
MSFTCETO2841L-BGRN-BGRN	Beige Green Laminate/Beige Green	USD 1,360.00	-

**SOFT TABLE / Ø 95 H: 73 CM / Ø 37.4 H: 28.7"**

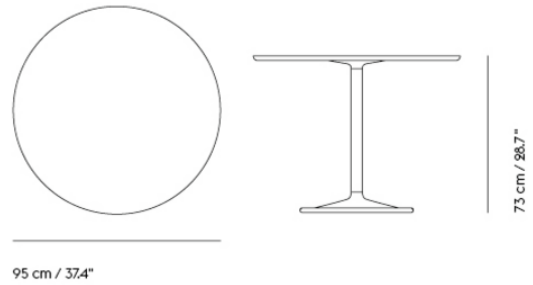

Shipper Colli	3
Gross Weight (kg)	28.3
Net Weight (kg)	22.904
Warranty period	5 years

Pattern No.	Color	Contract Price	Lead Time
<b>Ready-To-Ship US Warehouse</b>			
MSFTT03729N-BLCK-BLCK	Black Nanolaminate/Black	USD 1,465.00	-
MSFTT03729O-GREY-GREY	Grey Linoleum/Grey	USD 1,416.00	-
MSFTT03729W-BLCK-DOAK	Dark Oiled Oak/Black	USD 1,570.00	-
MSFTT03729W-GREY-SOAK	Solid Oak/Grey	USD 1,570.00	-
<b>Ready-To-Ship EU Warehouse</b>			
MSFTT03729L-BGRN-BGRN	Beige Green Laminate/Beige Green	USD 1,416.00	-

**SOFT TABLE / Ø 95 H: 95 CM / Ø 37.4 H: 37.4"**

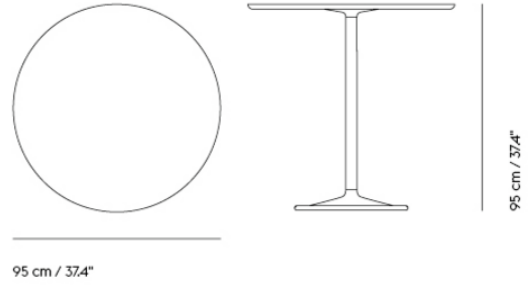

**Shipper Colli** 3  
**Gross Weight (kg)** 28.623  
**Net Weight (kg)** 23.197  
**Warranty period** 5 years

Pattern No.	Color	Contract Price	Lead Time
<b>Ready-To-Ship US Warehouse</b>			
MSFTT03737N-BLCK-BLCK	Black Nanolaminate/Black	USD 1,570.00	-
MSFTT03737O-GREY-GREY	Grey Linoleum/Grey	USD 1,465.00	-
MSFTT03737W-BLCK-DOAK	Dark Oiled Oak/Black	USD 1,626.00	-
MSFTT03737W-GREY-SOAK	Solid Oak/Grey	USD 1,626.00	-
<b>Ready-To-Ship EU Warehouse</b>			
MSFTT03737L-BGRN-BGRN	Beige Green Laminate/Beige Green	USD 1,465.00	-



**SOFT TABLE / Ø 95 H: 105 CM / Ø 37.4 H:  
41.3"**

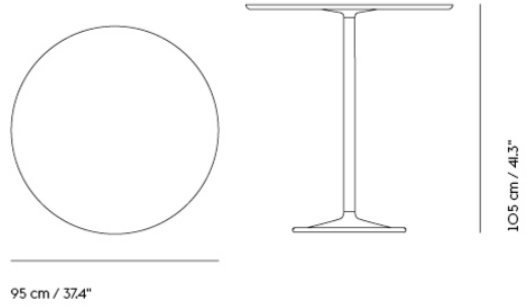

**Shipper Colli** 3  
**Gross Weight (kg)** 28.777  
**Net Weight (kg)** 23.341  
**Warranty period** 5 years

Pattern No.	Color	Contract Price	Lead Time
<b>Ready-To-Ship US Warehouse</b>			
MSFTT03741N-BLCK-BLCK	Black Nanolaminate/Black	USD 1,570.00	-
MSFTT03741O-GREY-GREY	Grey Linoleum/Grey	USD 1,465.00	-
MSFTT03741W-BLCK-DOAK	Dark Oiled Oak/Black	USD 1,626.00	-
MSFTT03741W-GREY-SOAK	Solid Oak/Grey	USD 1,626.00	-
<b>Ready-To-Ship EU Warehouse</b>			
MSFTT03741L-BGRN-BGRN	Beige Green Laminate/Beige Green	USD 1,465.00	-

# STACKED STORAGE SYSTEM

FOR MORE INFORMATION,  
EXPLORE BELOW

- ↗ [Product Fact Sheet](#)
- ↗ [Images](#)
- ↗ [Architect Files](#)
- ↗ [Assembly Instructions](#)
- ↗ [Product Declaration](#)
- ↗ [Product Planner](#)

Being both versatile and functional, the Stacked Storage System can be arranged and rearranged for the exact configuration that you'd like, whether it be as shelving setups, sideboards, bookcases, or side tables.

Option A — Choose between one of our 24 pre-designed configurations.

Option B — Design your own configuration from scratch using our diverse range of modules, bases, and accessories. Find guidance on the next pages or visit [planner.muuto.com/Stacked](http://planner.muuto.com/Stacked) to create your own configuration online.

The online Product Planner seamlessly integrates every guideline and assembly instruction, ensuring a smoother path to a Stacked Storage System customized for your spatial requirements!

## Option A — Choose between one of our 24 pre-designed configurations

### Bookcase

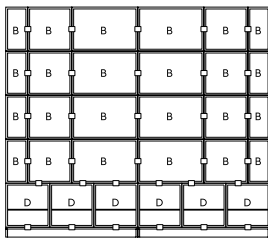

**Bookcase 1**  
W 262 cm / 103.15"  
H 228 cm / 89.76"  
D 35 cm / 13.78"

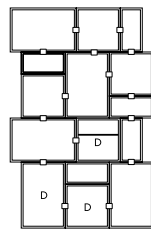

**Bookcase 2**  
W 150 cm / 59.06"  
H 218 cm / 85.83"  
D 35 cm / 13.78"

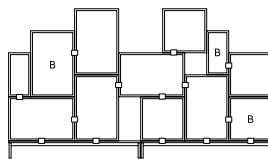

**Bookcase 3**  
W 262 cm / 103.15"  
H 148 cm / 58.27"  
D 35 cm / 13.78"

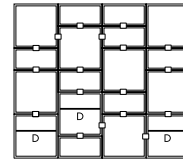

**Bookcase 4**  
W 175 cm / 68.9"  
H 153 cm / 60.24"  
D 35 cm / 13.78"

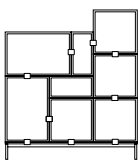

**Bookcase 5**  
W 131 cm / 51.57"  
H 148 cm / 58.27"  
D 35 cm / 13.78"

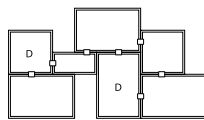

**Bookcase 6**  
W 196 cm / 77.17"  
H 109 cm / 42.91"  
D 35 cm / 13.78"

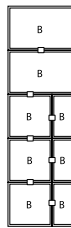

**Bookcase 7 (Wall-mounted)**  
W 65 cm / 25.59"  
H 218 cm / 85.83"  
D 35 cm / 13.78"

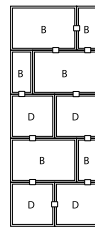

**Bookcase 8**  
W 87 cm / 34.25"  
H 218 cm / 85.83"  
D 35 cm / 13.78"

### Sideboard

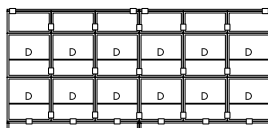

**Sideboard 1**  
W 262 cm / 103.15"  
H 121 cm / 47.64"  
D 35 cm / 13.78"

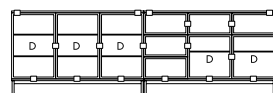

**Sideboard 2**  
W 262 cm / 103.15"  
H 85 cm / 33.46"  
D 35 cm / 13.78"

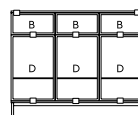

**Sideboard 3**  
W 131 cm / 51.57"  
H 106 cm / 41.73"  
D 35 cm / 13.78"

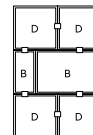

**Sideboard 4**  
W 87 cm / 34.25"  
H 131 cm / 51.57"  
D 35 cm / 13.78"

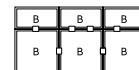

**Sideboard 5 (Wall-mounted)**  
W 131 cm / 51.57"  
H 65 cm / 34.25"  
D 35 cm / 13.78"

B = module w. backboard  
D = module w. door

The illustrations of Clips are for visual reference.

All 24 pre-designed configurations are tested according to European standard EN 16121:30I3+AI:20I7 Test Severity 2.

Please follow assembly rules and configuration guidelines when building your Stacked Storage System configuration.

## Hallway

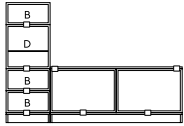

Hallway 1  
W 174 cm / 68.5"  
H 119 cm / 46.85"  
D 35 cm / 13.78"

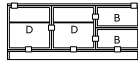

Hallway 2  
W 131 cm / 51.57"  
H 55 cm / 21.65"  
D 35 cm / 13.78"

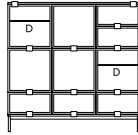

Hallway 3  
W 131 cm / 51.57"  
H 128 cm / 50.39"  
D 35 cm / 13.78"



Hallway 4 (Wall-mounted)  
W 87 cm / 34.25"  
H 87 cm / 34.25"  
D 35 cm / 13.78"

## Office

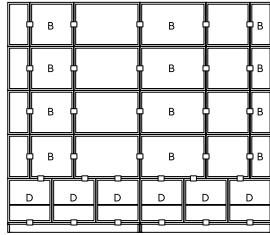

Office 1  
W 262 cm / 103.15"  
H 228 cm / 89.76"  
D 35 cm / 13.78"

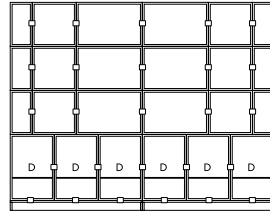

Office 2  
W 262 cm / 103.15"  
H 206 cm / 81.1"  
D 35 cm / 13.78"

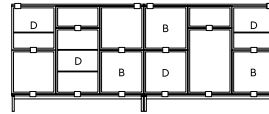

Office 3  
W 262 cm / 103.15"  
H 106 cm / 41.73"  
D 35 cm / 13.78"



Office 4  
W 44 cm / 17.32"  
H 141 cm / 55.51"  
D 35 cm / 13.78"

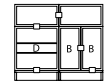

Office 5  
W 87 cm / 34.25"  
H 75 cm / 29.53"  
D 35 cm / 13.78"

## Bedside Table



Bedside 1  
W 174 cm / 68.5"  
H 119 cm / 46.86"  
D 35 cm / 13.78"



Bedside 2  
W 131 cm / 51.57"  
H 55 cm / 21.65"  
D 35 cm / 13.78"

## Option B — Design your own configuration

### STEP 1. BASE

All Modules can be placed directly on the floor and Modules w. Back-board or w. Door can be mounted to a wall. You can also add your desired base, choosing from the base options as seen on the right.

All bases come in 4 different colors: Grey, White, Brown Green, Oak. Podium w. Tube Base always comes with Grey Tube Base.

#### Notes

When setting up a Stacked Storage System on a Podium or Plinth, attach clips to the bottom of each connected module on both the front and back.

All Podiums and Plinths feature 4 adjustable feet to accommodate uneven floors. Please be aware that for the Plinths, the holes for the adjustable feet at the ends may be visible if not covered by Modules.

A Stacked Podium is tested to withstand a maximum weight of 300 kg / 660 lbs.



Podium w. Tube Base  
W 130,8 cm / 51.5"

H 171,5 cm / 6,75"  
D 35 cm / 13,78"



Podium w. Tube Base  
W 43,6 cm / 17,17"

H 171,5 cm / 6,75"  
D 35 cm / 13,78"



Plinth  
W 130,8 cm / 51.5"

H 9,8 cm / 3,86"  
D 35 cm / 13,78"



Plinth  
W 43,6 cm / 17,17"

H 9,8 cm / 3,86"  
D 35 cm / 13,78"

## STEP 2. MODULES

Select the Modules of your configuration, choosing from the modules shown on the right.

All modules come in 4 different colors: Grey, White, Brown Green, Oak.

### Notes







You must only stack a maximum of 5 Modules on top of each other, reaching a height no taller than 240 cm / 94.49 inches.

Door Modules must always be placed so the door opens vertically. Never place Door Modules horizontally.

Position Stacked Medium w. Door Modules no higher than 148 cm / 58.26 inches above the ground. Stacked Large w. Door Modules should only be placed on the 1st row of a configuration.

A Stacked Module is tested to hold up to 25 kg / 55 lbs.

A wall-mounted Stacked Module is tested to hold up to 12 kg / 26.5 lbs.

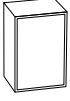
				H 43,6 cm / 17,95" D 35 cm / 13,78"	
Small Open W 21,8 cm / 8,58"	Small w. Backboard W 21,8 cm / 8,58"				
					H 43,6 cm / 17,95" D 35 cm / 13,78"
Medium Open W 43,6 cm / 17,17"	Medium w. Backboard W 43,6 cm / 17,17"	Medium w. Door W 43,6 cm / 17,17"			
					H 43,6 cm / 17,95" D 35 cm / 13,78"
Large Open W 65,4 cm / 25,75"	Large w. Backboard W 65,4 cm / 25,75"	Large w. Door W 65,4 cm / 25,75"			

## STEP 3. TOP PLATE OR SEAT CUSHION

If relevant, add your desired number of Top Plates for a nice finish when e.g. building a sideboard configuration. Add a Seat Cushion to create a cozy nook providing additional comfort, e.g. when building a bench for your Hallway.





Top Plates come in 4 different colors: Grey, White, Brown Green, Oak.

### Notes

Do not build any Stacked Storage Systems taller than 130 cm / 51.18" when building a configuration with a Top Plate. Do not build with a Top Plate if the configuration is wall-mounted.

When building with a Top Plate, minimum 4 Clips must be placed in each corner to secure the Top Plate.

The Top Plate(s) must be placed evenly on the Modules, meaning that the Top Plate(s) must not be placed so that the Top Plate(s) are sticking out from the side of the Modules beneath.



			H 1,85 cm / 73" D 35 cm / 13,78"
Top Plate L 130,8 cm / 51,57"			
			H 1,85 cm / 73" D 35 cm / 13,78"
Top Plate L 43,6 cm / 17,17"			
			H 5 cm / 1,97" D 35 cm / 13,78"
Seat Cushion Leather L 131 cm / 51,57"			
			H 5 cm / 1,97" D 35 cm / 13,78"
Seat Cushion Textile L 131 cm / 51,57"			

## STEP 4. SHELVES

Add your desired Shelves or Inserts.

Shelves come in 4 different colors: Grey, White, Brown Green, Oak.

Inserts come in 2 different colors: Grey, Blue Grey.

	H 1,05 cm / 41" D 28,7 cm / 11,3"		H 9,0 cm / 7,87" D 28,2 cm / 11,1"
Shelf W 39,7 cm / 15,63"		Insert W 39,6 cm / 15,59"	

### Notes

Shelves can be positioned in two fixed positions inside modules w. door. Inserts can be placed in open modules and modules w. backboard.

## STEP 5. CLIPS

Each module comes with two Clips in the same color as the module, while Oak comes with two Clips in Grey.

Identify the amount of possible extra Clips required to connect the modules in your configuration, following the guidelines below.

	H 4,1 cm / 1,61" D 2,39 cm / 94"
Clip W 4,17 cm / 1,64"	

### Notes

Clips must always be used when joining together Modules, Bases and Top Plates. The Clips must connect the elements in the system from left to right to ensure the overall stability of the Stacked Storage System.

As a general rule, attach one clip to the front and one to the back of each module. When placing a Stacked clip on the backside of a Stacked Module with a Door, you must always position it at the bottom, both at the front and back.

Extra clips can be purchased separately to increase the configuration's stability. You can buy extra Clips in set of two.

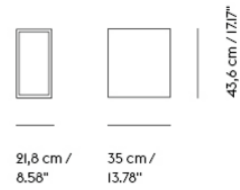

**Shipper Colli** 1  
**Gross Weight (kg)** 8.9  
**Net Weight (kg)** 6.7  
**Warranty period** 5 years

Pattern No.	Color	Contract Price	Lead Time
<b>Ready-To-Ship US Warehouse</b>			
MSSTMSO-BRGR	Brown Green	USD 226.00	-
MSSTMSO-GREY	Grey ***	USD 226.00	-
MSSTMSO-MBLU	Midnight Blue ***	USD 226.00	-
MSSTMSO-OAK	Oak	USD 226.00	-
MSSTMSO-WHIT	White	USD 226.00	-

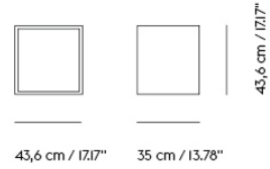

**Shipper Colli** 1  
**Gross Weight (kg)** 11.9  
**Net Weight (kg)** 9.1  
**Warranty period** 5 years

Pattern No.	Color	Contract Price	Lead Time
<b>Ready-To-Ship US Warehouse</b>			
MSSTMMO-BRGR	Brown Green	USD 289.00	-
MSSTMMO-GREY	Grey ***	USD 289.00	-
MSSTMMO-MBLU	Midnight Blue ***	USD 289.00	-
MSSTMMO-OAK	Oak	USD 289.00	-
MSSTMMO-WHIT	White	USD 289.00	-

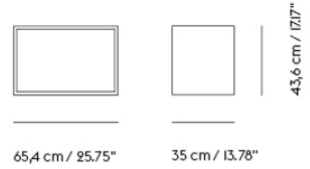

**Shipper Colli** | 1  
**Gross Weight (kg)** | 14.8  
**Net Weight (kg)** | 11.8  
**Warranty period** | 5 years

Pattern No.	Color	Contract Price	Lead Time
<b>Ready-To-Ship US Warehouse</b>			
MSSTMLO-BRGR	Brown Green	USD 331.00	-
MSSTMLO-GREY	Grey ***	USD 331.00	-
MSSTMLO-MBLU	Midnight Blue ***	USD 331.00	-
MSSTMLO-OAK	Oak	USD 331.00	-
MSSTMLO-WHIT	White	USD 331.00	-



# STACKED STORAGE SYSTEM / SMALL WITH BACKBOARD

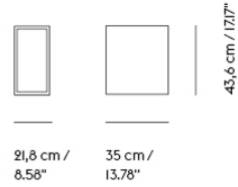

**Shipper Colli** 1  
**Gross Weight (kg)** 10  
**Net Weight (kg)** 7.2  
**Warranty period** 5 years

Pattern No.	Color	Contract Price	Lead Time
<b>Ready-To-Ship US Warehouse</b>			
MSSTMSB-BRGR	Brown Green	USD 257.00	-
MSSTMSB-GREY	Grey ***	USD 257.00	-
MSSTMSB-MBLU	Midnight Blue ***	USD 257.00	-
MSSTMSB-OAK	Oak	USD 257.00	-
MSSTMSB-WHIT	White	USD 257.00	-

# STACKED STORAGE SYSTEM / MEDIUM WITH BACKBOARD

423

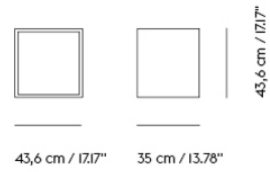

**Shipper Colli** 1  
**Gross Weight (kg)** 13.3  
**Net Weight (kg)** 10.2  
**Warranty period** 5 years

Pattern No.	Color	Contract Price	Lead Time
<b>Ready-To-Ship US Warehouse</b>			
MSSTMMB-BRGR	Brown Green	USD 331.00	-
MSSTMMB-GREY	Grey ***	USD 331.00	-
MSSTMMB-OAK	Oak	USD 331.00	-
MSSTMMB-ODGRN	Oak/Dusty Green ***	USD 331.00	-
MSSTMMB-OGREY	Oak/Grey	USD 331.00	-
MSSTMMB-WHIT	White	USD 331.00	-

# STACKED STORAGE SYSTEM / LARGE WITH BACKBOARD

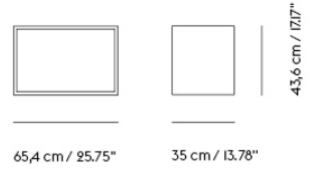

**Shipper Colli** | 1  
**Gross Weight (kg)** | 16.42  
**Net Weight (kg)** | 12.8  
**Warranty period** | 5 years

Pattern No.	Color	Contract Price	Lead Time
<b>Ready-To-Ship US Warehouse</b>			
MSSTMLB-BRGR	Brown Green	USD 362.00	-
MSSTMLB-GREY	Grey ***	USD 362.00	-
MSSTMLB-OAK	Oak	USD 362.00	-
MSSTMLB-WHIT	White	USD 362.00	-
<b>Ready-To-Ship EU Warehouse</b>			
MSSTMLB-MBLU	Midnight Blue ***	USD 362.00	-

# STACKED STORAGE SYSTEM / MEDIUM WITH DOOR

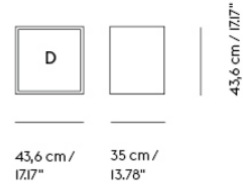

**Shipper Colli** 1  
**Gross Weight (kg)** 15.5  
**Net Weight (kg)** 12.3  
**Warranty period** 5 years

Pattern No.	Color	Contract Price	Lead Time
<b>Ready-To-Ship US Warehouse</b>			
MSSTMMD-BRGR	Brown Green	USD 341.00	-
MSSTMMD-MBLU	Midnight Blue ***	USD 341.00	-
MSSTMMD-OAK	Oak	USD 341.00	-
MSSTMMD-WHIT	White	USD 341.00	-
<b>Ready-To-Ship EU Warehouse</b>			
MSSTMMD-GREY	Grey	USD 341.00	-
<b>Extras</b>			
MSSTMSLF-BRGR	Shelf - Brown Green	USD 142.00	-
MSSTMSLF-GREY	Shelf - Grey	USD 142.00	-
MSSTMSLF-OAK	Shelf - Oak	USD 142.00	-
MSSTMSLF-WHIT	Shelf - White	USD 142.00	-

# STACKED STORAGE SYSTEM / LARGE WITH DOOR

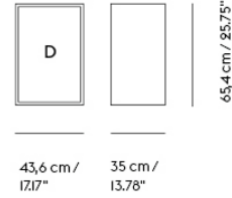

**Shipper Colli** 1  
**Gross Weight (kg)** 17.5  
**Net Weight (kg)** 12.5  
**Warranty period** 5 years

Pattern No.	Color	Contract Price	Lead Time
<b>Ready-To-Ship US Warehouse</b>			
MSSTMLD-BRGR	Brown Green	USD 450.00	-
MSSTMLD-OAK	Oak	USD 450.00	-
MSSTMLD-WHIT	White	USD 450.00	-
<b>Ready-To-Ship EU Warehouse</b>			
MSSTMLD-GREY	Grey	USD 450.00	-
<b>Extras</b>			
MSSTMSLF-BRGR	Shelf - Brown Green	USD 142.00	-
MSSTMSLF-GREY	Shelf - Grey	USD 142.00	-
MSSTMSLF-OAK	Shelf - Oak	USD 142.00	-
MSSTMSLF-WHIT	Shelf - White	USD 142.00	-

**STACKED STORAGE SYSTEM / PLINTH -  
43,5 X 35 H: 10 CM / 17.15 X 13.75 H: 3.8"**

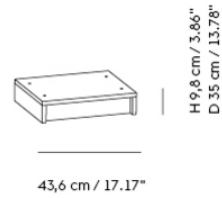

Shipper Colli 1  
 Gross Weight (kg) 5.2  
 Net Weight (kg) 3.9  
 Warranty period 5 years

Pattern No.	Color	Contract Price	Lead Time
<b>Ready-To-Ship US Warehouse</b>			
MSSTMSHPL-BRGR	Brown Green	USD 394.00	-
MSSTMSHPL-OAK	Oak	USD 394.00	-
MSSTMSHPL-WHIT	White	USD 394.00	-
<b>Ready-To-Ship EU Warehouse</b>			
MSSTMSHPL-GREY	Grey	USD 394.00	-

**STACKED STORAGE SYSTEM / PLINTH - 131**  
**X 35 H: 10 CM / 51.5 X 13.75 H: 3.8"**

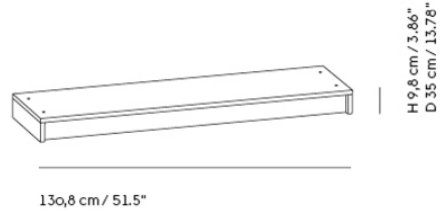

Shipper Colli |  
 Gross Weight (kg) 12.4  
 Net Weight (kg) 8.96  
 Warranty period 5 years

Pattern No.	Color	Contract Price	Lead Time
<b>Ready-To-Ship US Warehouse</b>			
MSSTMLNPL-BRGR	Brown Green	USD 530.00	-
MSSTMLNPL-OAK	Oak	USD 530.00	-
MSSTMLNPL-WHIT	White	USD 530.00	-
<b>Ready-To-Ship EU Warehouse</b>			
MSSTMLNPL-GREY	Grey	USD 530.00	-

**STACKED STORAGE SYSTEM / PODIUM W.  
TUBE BASE - 43,5 X 35 H: 17 CM / 17.15 X  
13.75 H: 6.75"**



Shipper Colli 2  
 Gross Weight (kg) 4.2  
 Net Weight (kg) 3.8  
 Warranty period 5 years

Pattern No.	Color	Contract Price	Lead Time
<b>Ready-To-Ship US Warehouse</b>			
MSSTMSHPD-BRGR	Brown Green/Grey	USD 450.00	-
MSSTMSHPD-OAK	Oak/Grey	USD 450.00	-
MSSTMSHPD-WHIT	White/Grey	USD 450.00	-
<b>Ready-To-Ship EU Warehouse</b>			
MSSTMSHPD-GREY	Grey/Grey	USD 450.00	-



**STACKED STORAGE SYSTEM / PODIUM W.  
TUBE BASE - 131 X 35 H: 17 CM / 51.5 X 13.75  
H: 6.75"**

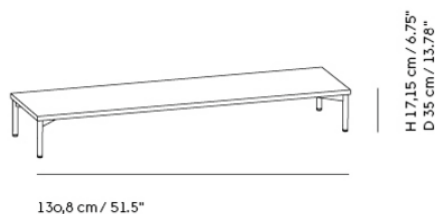

Shipper Colli	2
Gross Weight (kg)	10.8
Net Weight (kg)	8.3
Warranty period	5 years

Pattern No.	Color	Contract Price	Lead Time
<b>Ready-To-Ship US Warehouse</b>			
MSSTMLNPD-BRGR	Brown Green/Grey	USD 660.00	-
MSSTMLNPD-OAK	Oak/Grey	USD 660.00	-
MSSTMLNPD-WHIT	White/Grey	USD 660.00	-
<b>Ready-To-Ship EU Warehouse</b>			
MSSTMLNPD-GREY	Grey/Grey	USD 660.00	-



**Shipper Colli** 1  
**Gross Weight (kg)** 2.8  
**Net Weight (kg)** 2.7  
**Please note** Inserts can be placed in open modules and modules w. backboard.  
**Warranty period** 5 years

Pattern No.	Color	Contract Price	Lead Time
<b>Ready-To-Ship US Warehouse</b>			
MSSTMIN-BLGY	Blue Grey	USD 100.00	-
<b>Ready-To-Ship EU Warehouse</b>			
MSSTMIN-GREY	Grey	USD 100.00	-



**Shipper Colli** 1  
**Gross Weight (kg)** 1.5  
**Net Weight (kg)** 0.88  
**Please note** The Stacked Storage System Shelves can be added to the Stacked Storage System Modules w. Door  
**Please note** Shelves can be positioned in two fixed positions inside modules w. door.  
**Warranty period** 5 years

Pattern No.	Color	Contract Price	Lead Time
<b>Ready-To-Ship US Warehouse</b>			
MSSTMSLF-BRGR	Shelf - Brown Green	USD 142.00	-
MSSTMSLF-OAK	Shelf - Oak	USD 142.00	-
MSSTMSLF-WHIT	Shelf - White	USD 142.00	-
<b>Ready-To-Ship EU Warehouse</b>			
MSSTMSLF-GREY	Shelf - Grey	USD 142.00	-

**STACKED STORAGE SYSTEM / TOP PLATE -  
43,5 X 35 / 17.15 X 13.75"**

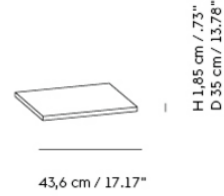

Shipper Colli 1  
 Gross Weight (kg) 2.5  
 Net Weight (kg) 1.75  
 Warranty period 5 years

Pattern No.	Color	Contract Price	Lead Time
<b>Ready-To-Ship US Warehouse</b>			
MSSTMSHTP-BRGR	Brown Green	USD 226.00	-
MSSTMSHTP-OAK	Oak	USD 226.00	-
MSSTMSHTP-WHIT	White	USD 226.00	-
<b>Ready-To-Ship EU Warehouse</b>			
MSSTMSHTP-GREY	Grey	USD 226.00	-

**STACKED STORAGE SYSTEM / TOP PLATE -  
131 X 35 / 51.5 X 13.75"**

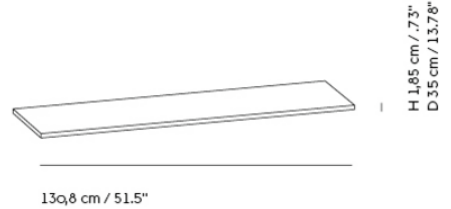

Shipper Colli |  
 Gross Weight (kg) 7.5  
 Net Weight (kg) 5.19  
 Warranty period 5 years

Pattern No.	Color	Contract Price	Lead Time
<b>Ready-To-Ship US Warehouse</b>			
MSSTMLNTP-BRGR	Brown Green	USD 335.00	-
MSSTMLNTP-OAK	Oak	USD 335.00	-
MSSTMLNTP-WHIT	White	USD 335.00	-
<b>Ready-To-Ship EU Warehouse</b>			
MSSTMLNTP-GREY	Grey	USD 335.00	-

**STACKED STORAGE SYSTEM / EXTRA CLIPS (2 PCS)**

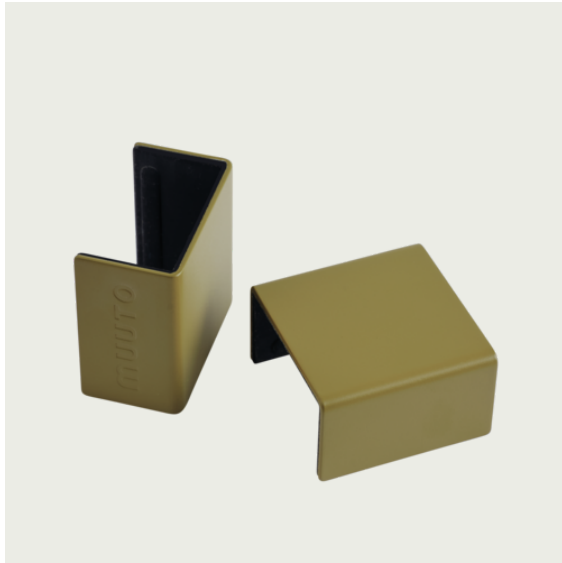

Shipper Colli 1  
 Gross Weight (kg) 0.078  
 Net Weight (kg) 0.073  
 Warranty period 5 years

Pattern No.	Color	Contract Price	Lead Time
<b>Ready-To-Ship US Warehouse</b>			
MSSTC2PC-DGRN	Brown Green	USD 35.00	-
MSSTC2PC/GREY	Grey	USD 35.00	-
MSSTC2PC/WHIT	White	USD 35.00	-

# STACKED STORAGE SYSTEM / CLIPS SET OF 5

436



Shipper Colli 1  
Gross Weight (kg) 0.194  
Net Weight (kg) 0.187  
Warranty period 5 years

Pattern No.	Color	Contract Price	Lead Time
<b>Ready-To-Ship US Warehouse</b>			
MSSTC-MBLU	Midnight Blue	USD 39.00	-
MSSTC-WHIT	White	USD 39.00	-

**STACKED STORAGE SYSTEM / ACOUSTIC  
PANEL / SMALL**

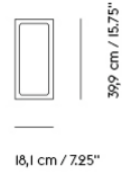
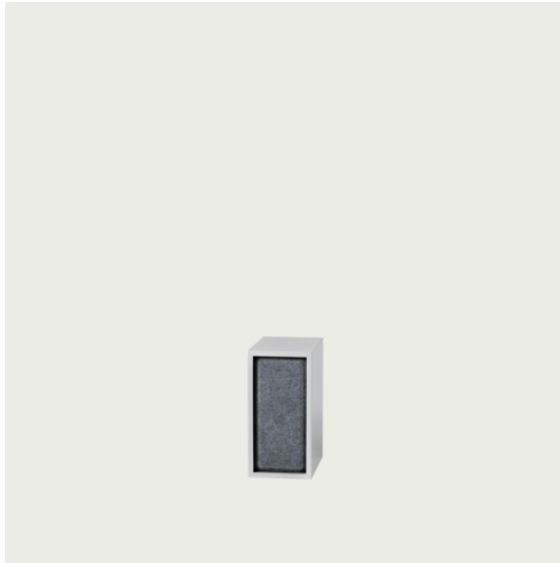

Shipper Colli 1  
 Gross Weight (kg) 0.25  
 Net Weight (kg) 0.15  
 Warranty period 5 years

Pattern No.	Color	Contract Price	Lead Time
<b>Ready-To-Ship EU Warehouse</b>			
MSSTAPSM-AQME	Aqua Mélange	USD 72.00 >MOQ: 2	-
MSSTAPSM-BLME	Black Mélange	USD 72.00 >MOQ: 2	-
MSSTAPSM-GRME	Grey Mélange	USD 72.00 >MOQ: 2	-



# STACKED STORAGE SYSTEM / ACOUSTIC PANEL - MEDIUM

438

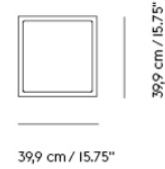
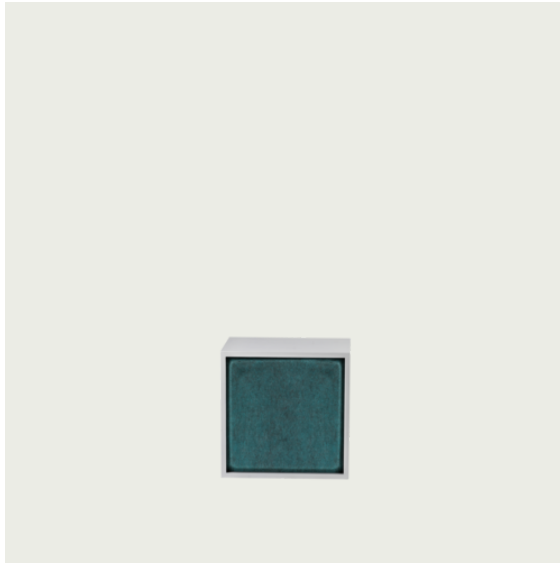

**Shipper Colli** 1  
**Gross Weight (kg)** 0.4  
**Net Weight (kg)** 0.3  
**Warranty period** 5 years

Pattern No.	Color	Contract Price	Lead Time
<b>Ready-To-Ship EU Warehouse</b>			
MSSTAPMD-AQME	Aqua Mélange	USD 100.00 >MOQ: 2	-
MSSTAPMD-BLME	Black Mélange	USD 100.00 >MOQ: 2	-
MSSTAPMD-GRME	Grey Mélange	USD 100.00 >MOQ: 2	-

# STACKED STORAGE SYSTEM / ACOUSTIC PANEL / LARGE

439

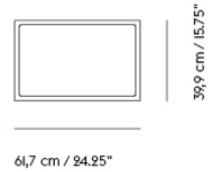

Shipper Colli	1
Gross Weight (kg)	0.6
Net Weight (kg)	0.5
Warranty period	5 years

Pattern No.	Color	Contract Price	Lead Time
<b>Ready-To-Ship EU Warehouse</b>			
MSSTAPLG-BLME	Black Mélange	USD 121.00 >MOQ: 2	-
MSSTAPLG-GRME	Grey Mélange	USD 121.00 >MOQ: 2	-

# STACKED STORAGE SYSTEM / SEAT CUSHION

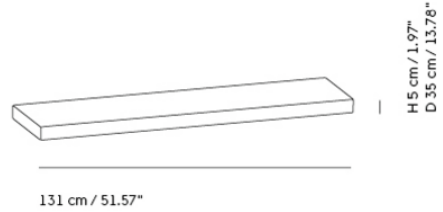

**Shipper Colli** |  
**Net Weight (kg)** 3.9  
**Warranty Period** 5 years

Pattern No.	Color	Contract Price	Lead Time
<b>Ready-To-Ship US Warehouse</b>			
MSSTCUS5113-M637649	Beck 49	USD 597.00	-
MSSTCUS5113-M136COGN	Refine Leather Cognac - 131 X 35 / 51.5 X 13.75"	USD 660.00	-

# STACKED STORAGE SYSTEM / BEDSIDE TABLE - CONFIGURATION I

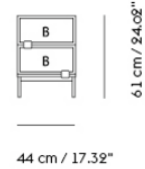
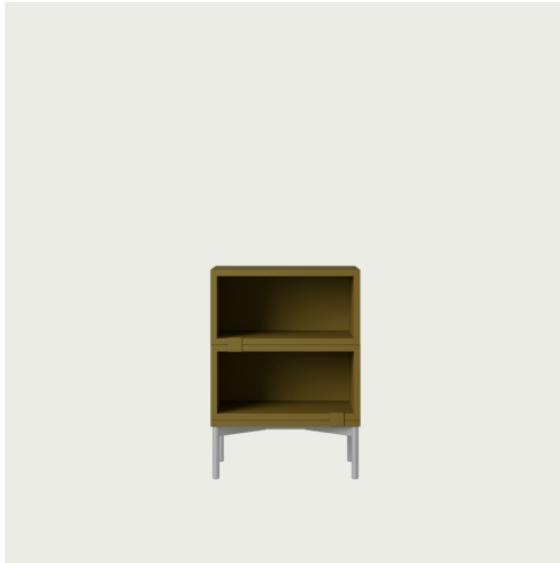

**Shipper Colli** 4  
**Gross Weight (kg)** 22.8  
**Net Weight (kg)** 16.24  
**Warranty period** 5 years

Pattern No.	Color	Contract Price	Lead Time
<b>Ready-To-Ship US Warehouse</b>			
MSSTCBS1-BRGR	Brown Green	USD 950.00	-
MSSTCBS1-OAK	Oak	USD 950.00	-
MSSTCBS1-WHIT	White	USD 950.00	-
<b>Ready-To-Ship EU Warehouse</b>			
MSSTCBS1-GREY	Grey	USD 950.00	-

# STACKED STORAGE SYSTEM / BEDSIDE TABLE - CONFIGURATION 2

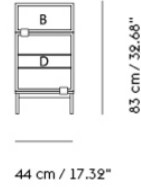

**Shipper Colli** 6  
**Gross Weight (kg)** 29.1  
**Net Weight (kg)** 21.005  
**Warranty period** 5 years

Pattern No.	Color	Contract Price	Lead Time
<b>Ready-To-Ship US Warehouse</b>			
MSSTCBS2-BRGR	Brown Green	USD 1,311.00	-
MSSTCBS2-OAK	Oak	USD 1,311.00	-
MSSTCBS2-WHIT	White	USD 1,311.00	-
<b>Ready-To-Ship EU Warehouse</b>			
MSSTCBS2-GREY	Grey	USD 1,311.00	-

# STACKED STORAGE SYSTEM / BOOKCASE - CONFIGURATION I

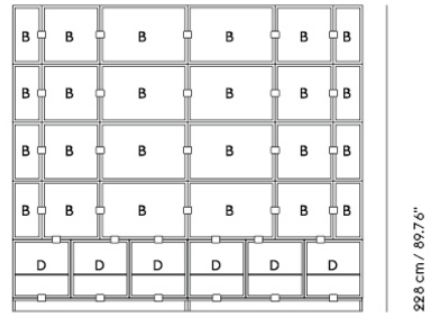

262 cm / 103.15"

Shipper Colli 40  
 Gross Weight (kg) 402.6  
 Net Weight (kg) 297.04  
 Warranty period 5 years

Pattern No.	Color	Contract Price	Lead Time
<b>Ready-To-Ship US Warehouse</b>			
MSSTCB1-BRGR	Brown Green	USD 11,545.00	-
MSSTCB1-OAK	Oak	USD 11,545.00	-
MSSTCB1-WHIT	White	USD 11,545.00	-
<b>Ready-To-Ship EU Warehouse</b>			
MSSTCB1-GREY	Grey	USD 11,545.00	-

# STACKED STORAGE SYSTEM / BOOKCASE - CONFIGURATION 2

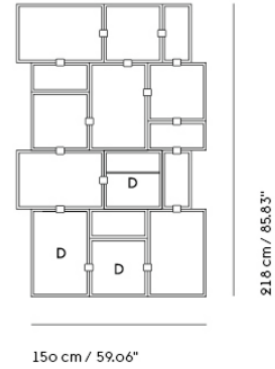
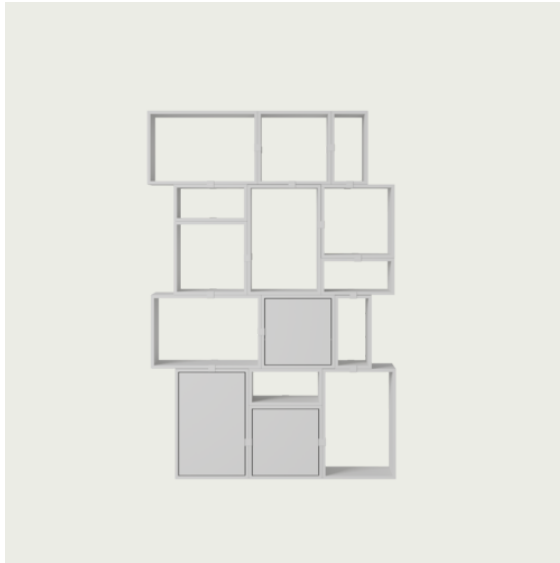

**Shipper Colli** 16  
**Gross Weight (kg)** 172.05  
**Net Weight (kg)** 129.26  
**Warranty period** 5 years

Pattern No.	Color	Contract Price	Lead Time
<b>Ready-To-Ship US Warehouse</b>			
MSSTCB2-BRGR	Brown Green	USD 4,510.00	-
MSSTCB2-OAK	Oak	USD 4,510.00	-
MSSTCB2-WHIT	White	USD 4,510.00	-
<b>Ready-To-Ship EU Warehouse</b>			
MSSTCB2-GREY	Grey	USD 4,510.00	-

# STACKED STORAGE SYSTEM / BOOKCASE - CONFIGURATION 3

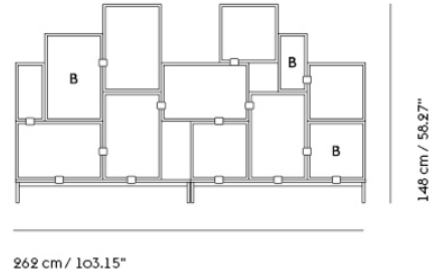
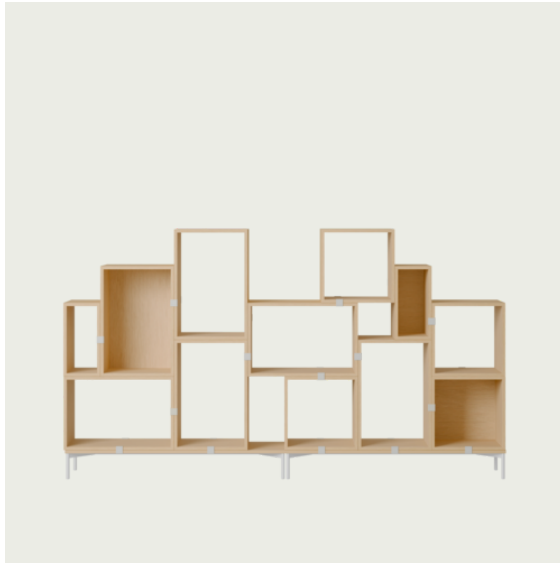

Shipper Colli 17  
 Gross Weight (kg) 166.8  
 Net Weight (kg) 126.565  
 Warranty period 5 years

Pattern No.	Color	Contract Price	Lead Time
<b>Ready-To-Ship US Warehouse</b>			
MSSTCB3-BRGR	Brown Green	USD 5,140.00	-
MSSTCB3-OAK	Oak	USD 5,140.00	-
MSSTCB3-WHIT	White	USD 5,140.00	-
<b>Ready-To-Ship EU Warehouse</b>			
MSSTCB3-GREY	Grey	USD 5,140.00	-



# STACKED STORAGE SYSTEM / BOOKCASE - CONFIGURATION 4

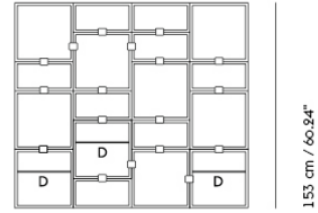
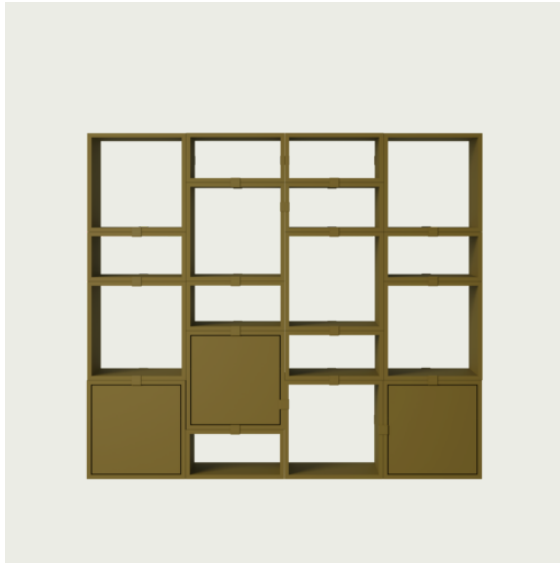

175 cm / 68.9"

153 cm / 60.24"

Shipper Colli	21
Gross Weight (kg)	184.55
Net Weight (kg)	137.76
Warranty period	5 years

Pattern No.	Color	Contract Price	Lead Time
<b>Ready-To-Ship US Warehouse</b>			
MSSTCB4-BRGR	Brown Green	USD 5,140.00	-
MSSTCB4-OAK	Oak	USD 5,140.00	-
MSSTCB4-WHIT	White	USD 5,140.00	-
<b>Ready-To-Ship EU Warehouse</b>			
MSSTCB4-GREY	Grey	USD 5,140.00	-

# STACKED STORAGE SYSTEM / BOOKCASE - CONFIGURATION 5

447

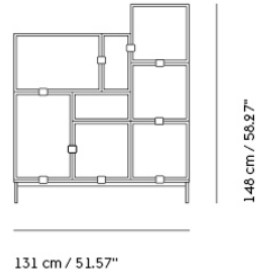
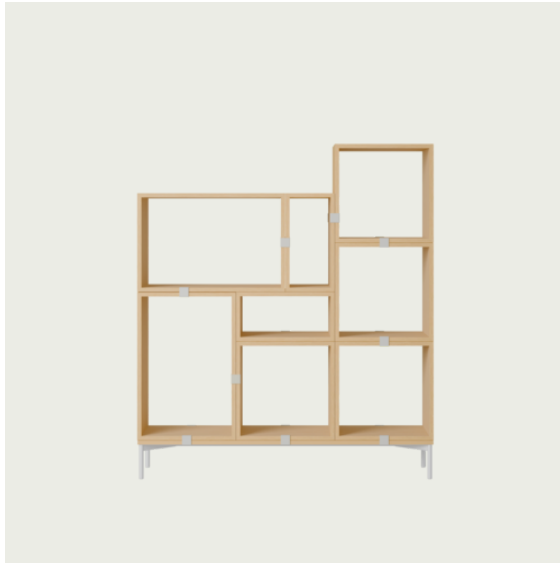

Shipper Colli	10
Gross Weight (kg)	98
Net Weight (kg)	74.33
Warranty period	5 years

Pattern No.	Color	Contract Price	Lead Time
<b>Ready-To-Ship US Warehouse</b>			
MSSTCB5-BRGR	Brown Green	USD 2,886.00	-
MSSTCB5-OAK	Oak	USD 2,886.00	-
MSSTCB5-WHIT	White	USD 2,886.00	-
<b>Ready-To-Ship EU Warehouse</b>			
MSSTCB5-GREY	Grey	USD 2,886.00	-

**STACKED STORAGE SYSTEM / BOOKCASE  
- CONFIGURATION 6**

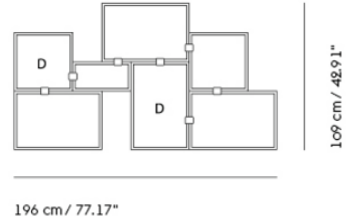
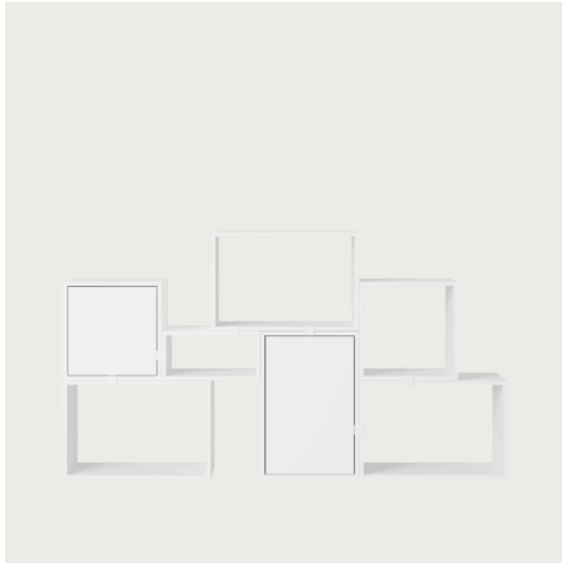

Shipper Colli 7  
 Gross Weight (kg) 89.75  
 Net Weight (kg) 67.56  
 Warranty period 5 years

Pattern No.	Color	Contract Price	Lead Time
<b>Ready-To-Ship US Warehouse</b>			
MSSTCB6-BRGR	Brown Green	USD 2,305.00	-
MSSTCB6-OAK	Oak	USD 2,305.00	-
MSSTCB6-WHIT	White	USD 2,305.00	-
<b>Ready-To-Ship EU Warehouse</b>			
MSSTCB6-GREY	Grey	USD 2,305.00	-

# STACKED STORAGE SYSTEM / BOOKCASE - CONFIGURATION 7

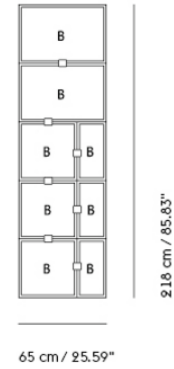

**Shipper Colli** 8  
**Gross Weight (kg)** 94.85  
**Net Weight (kg)** 69.815  
**Please note** This is a wall-mounted configuration  
**Warranty period** 5 years

Pattern No.	Color	Contract Price	Lead Time
<b>Ready-To-Ship US Warehouse</b>			
MSSTCB7-BRGR	Brown Green	USD 2,515.00	-
MSSTCB7-OAK	Oak	USD 2,515.00	-
MSSTCB7-WHIT	White	USD 2,515.00	-
<b>Ready-To-Ship EU Warehouse</b>			
MSSTCB7-GREY	Grey	USD 2,515.00	-

# STACKED STORAGE SYSTEM / BOOKCASE - CONFIGURATION 8

450

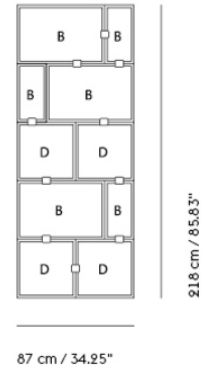
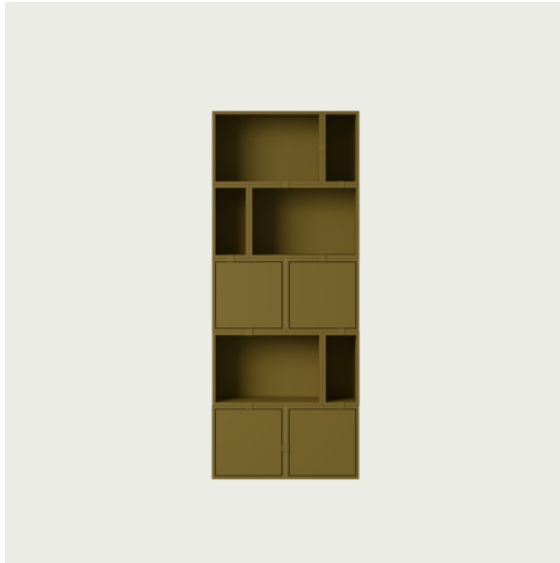

Shipper Colli	10
Gross Weight (kg)	123.6
Net Weight (kg)	91.985
Warranty period	5 years

Pattern No.	Color	Contract Price	Lead Time
<b>Ready-To-Ship US Warehouse</b>			
MSSTCB8-BRGR	Brown Green	USD 3,201.00	-
MSSTCB8-OAK	Oak	USD 3,201.00	-
MSSTCB8-WHIT	White	USD 3,201.00	-
<b>Ready-To-Ship EU Warehouse</b>			
MSSTCB8-GREY	Grey	USD 3,201.00	-

# STACKED STORAGE SYSTEM / HALLWAY STORAGE - CONFIGURATION I

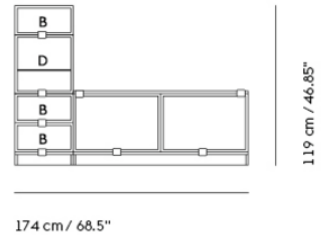
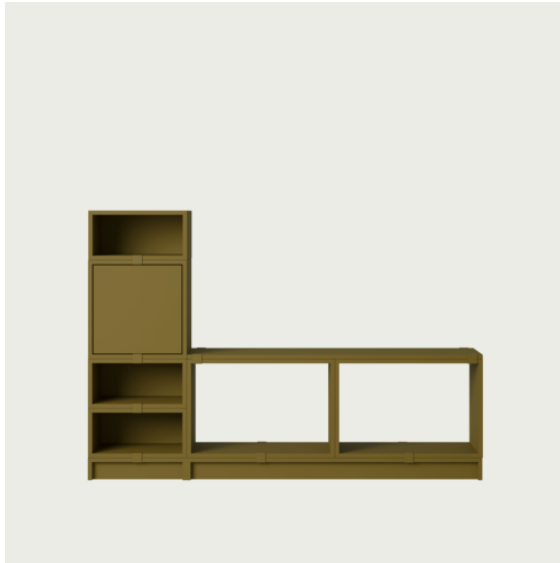

**Shipper Colli** 13  
**Gross Weight (kg)** 94.1  
**Net Weight (kg)** 68.715  
**Warranty period** 5 years

Pattern No.	Color	Contract Price	Lead Time
<b>Ready-To-Ship US Warehouse</b>			
MSSTCHS1-BRGR	Brown Green	USD 3,250.00	-
MSSTCHS1-OAK	Oak	USD 3,250.00	-
MSSTCHS1-WHIT	White	USD 3,250.00	-
<b>Ready-To-Ship EU Warehouse</b>			
MSSTCHS1-GREY	Grey	USD 3,250.00	-

# STACKED STORAGE SYSTEM / HALLWAY STORAGE - CONFIGURATION 2

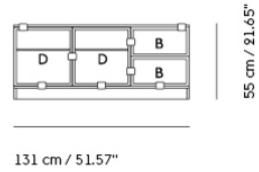

**Shipper Colli** II  
**Gross Weight (kg)** 66.7  
**Net Weight (kg)** 47.9  
**Warranty period** 5 years

Pattern No.	Color	Contract Price	Lead Time
<b>Ready-To-Ship US Warehouse</b>			
MSSTCHS2-BRGR	Brown Green	USD 2,410.00	-
MSSTCHS2-OAK	Oak	USD 2,410.00	-
MSSTCHS2-WHIT	White	USD 2,410.00	-
<b>Ready-To-Ship EU Warehouse</b>			
MSSTCHS2-GREY	Grey	USD 2,410.00	-

# STACKED STORAGE SYSTEM / HALLWAY STORAGE - CONFIGURATION 3

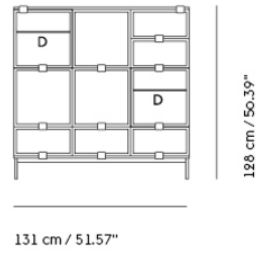

**Shipper Colli** 17  
**Gross Weight (kg)** 112.85  
**Net Weight (kg)** 84.33  
**Warranty period** 5 years

Pattern No.	Color	Contract Price	Lead Time
<b>Ready-To-Ship US Warehouse</b>			
MSSTCHS3-BRGR	Brown Green	USD 3,985.00	-
MSSTCHS3-OAK	Oak	USD 3,985.00	-
MSSTCHS3-WHIT	White	USD 3,985.00	-
<b>Ready-To-Ship EU Warehouse</b>			
MSSTCHS3-GREY	Grey	USD 3,985.00	-



# STACKED STORAGE SYSTEM / HALLWAY STORAGE - CONFIGURATION 4

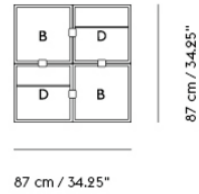
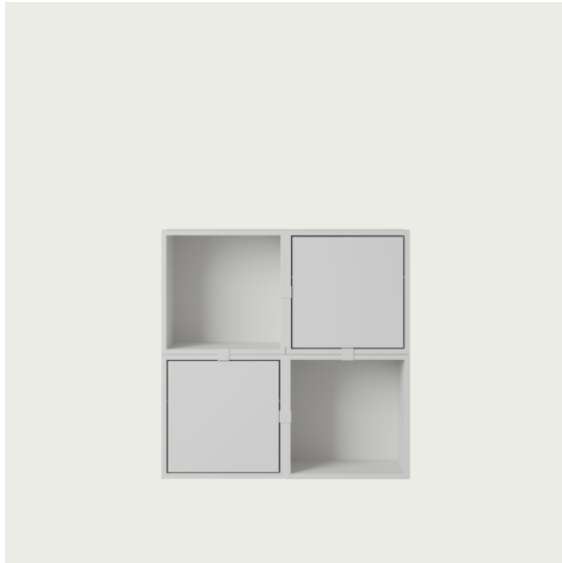

- Shipper Colli 6
- Gross Weight (kg) 52.7
- Net Weight (kg) 38.98
- Please note This is a wall-mounted configuration
- Warranty period 5 years

Pattern No.	Color	Contract Price	Lead Time
<b>Ready-To-Ship US Warehouse</b>			
MSSTCHS4-BRGR	Brown Green	USD 1,626.00	-
MSSTCHS4-OAK	Oak	USD 1,626.00	-
MSSTCHS4-WHIT	White	USD 1,626.00	-
<b>Ready-To-Ship EU Warehouse</b>			
MSSTCHS4-GREY	Grey	USD 1,626.00	-

# STACKED STORAGE SYSTEM / OFFICE STORAGE - CONFIGURATION I

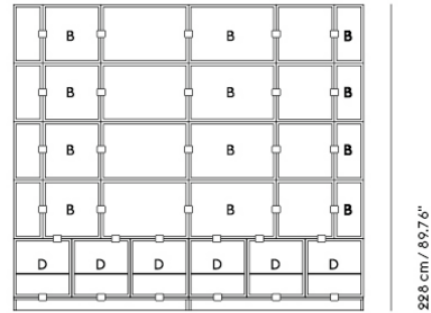

262 cm / 103.15"

228 cm / 89.76"

Shipper Colli 40  
 Gross Weight (kg) 386.6  
 Net Weight (kg) 287.66  
 Warranty period 5 years

Pattern No.	Color	Contract Price	Lead Time
<b>Ready-To-Ship US Warehouse</b>			
MSSTCOS1-BRGR	Brown Green	USD 11,020.00	-
MSSTCOS1-OAK	Oak	USD 11,020.00	-
MSSTCOS1-WHIT	White	USD 11,020.00	-
<b>Ready-To-Ship EU Warehouse</b>			
MSSTCOS1-GREY	Grey	USD 11,020.00	-

# STACKED STORAGE SYSTEM / OFFICE STORAGE - CONFIGURATION 2

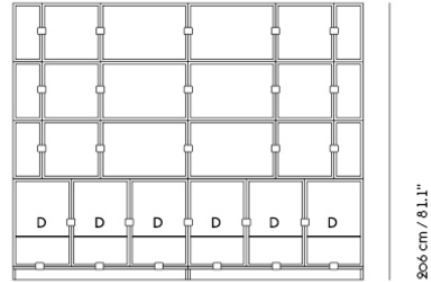

262 cm / 103.15"

Shipper Colli	33
Gross Weight (kg)	334.7
Net Weight (kg)	246.76
Warranty period	5 years

Pattern No.	Color	Contract Price	Lead Time
<b>Ready-To-Ship US Warehouse</b>			
MSSTCOS2-BRGR	Brown Green	USD 9,550.00	-
MSSTCOS2-OAK	Oak	USD 9,550.00	-
MSSTCOS2-WHIT	White	USD 9,550.00	-
<b>Ready-To-Ship EU Warehouse</b>			
MSSTCOS2-GREY	Grey	USD 9,550.00	-

# STACKED STORAGE SYSTEM / OFFICE STORAGE - CONFIGURATION 3

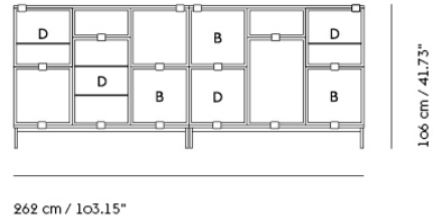

Shipper Colli	27
Gross Weight (kg)	171.45
Net Weight (kg)	127.55
Warranty period	5 years

Pattern No.	Color	Contract Price	Lead Time
<b>Ready-To-Ship US Warehouse</b>			
MSSTCOS3-BRGR	Brown Green	USD 7,240.00	-
MSSTCOS3-OAK	Oak	USD 7,240.00	-
MSSTCOS3-WHIT	White	USD 7,240.00	-
<b>Ready-To-Ship EU Warehouse</b>			
MSSTCOS3-GREY	Grey	USD 7,240.00	-

# STACKED STORAGE SYSTEM / OFFICE STORAGE - CONFIGURATION 4

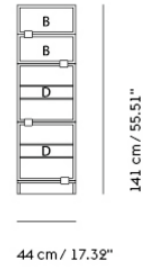

**Shipper Colli** 9  
**Gross Weight (kg)** 55  
**Net Weight (kg)** 39.41  
**Warranty period** 5 years

Pattern No.	Color	Contract Price	Lead Time
<b>Ready-To-Ship US Warehouse</b>			
MSSTCOS4-BRGR	Brown Green	USD 2,151.00	-
MSSTCOS4-OAK	Oak	USD 2,151.00	-
MSSTCOS4-WHIT	White	USD 2,151.00	-
<b>Ready-To-Ship EU Warehouse</b>			
MSSTCOS4-GREY	Grey	USD 2,151.00	-

# STACKED STORAGE SYSTEM / OFFICE STORAGE - CONFIGURATION 5

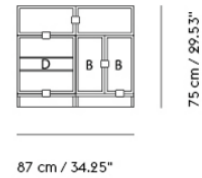

**Shipper Colli** 9  
**Gross Weight (kg)** 61  
**Net Weight (kg)** 44.25  
**Warranty period** 5 years

Pattern No.	Color	Contract Price	Lead Time
<b>Ready-To-Ship US Warehouse</b>			
MSSTCOS5-BRGR	Brown Green	USD 2,361.00	-
MSSTCOS5-OAK	Oak	USD 2,361.00	-
MSSTCOS5-WHIT	White	USD 2,361.00	-
<b>Ready-To-Ship EU Warehouse</b>			
MSSTCOS5-GREY	Grey	USD 2,361.00	-

# STACKED STORAGE SYSTEM / SIDEBORD - CONFIGURATION I

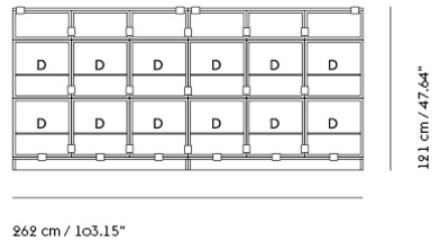
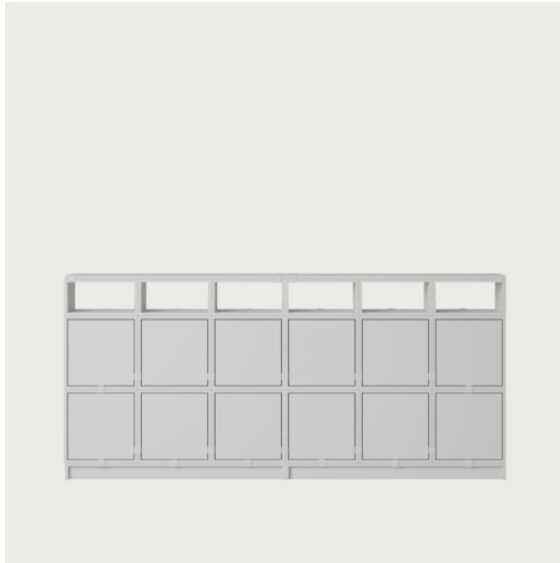

Shipper Colli	28
Gross Weight (kg)	240.2
Net Weight (kg)	178.9
Warranty period	5 years

Pattern No.	Color	Contract Price	Lead Time
<b>Ready-To-Ship US Warehouse</b>			
MSSTCS1-BRGR	Brown Green	USD 8,871.00	-
MSSTCS1-OAK	Oak	USD 8,871.00	-
MSSTCS1-WHIT	White	USD 8,871.00	-
<b>Ready-To-Ship EU Warehouse</b>			
MSSTCS1-GREY	Grey	USD 8,871.00	-

# STACKED STORAGE SYSTEM / SIDEBOARD - CONFIGURATION 2

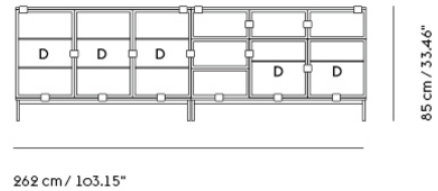

**Shipper Colli** 30  
**Gross Weight (kg)** 167.3  
**Net Weight (kg)** 121  
**Warranty period** 5 years

Pattern No.	Color	Contract Price	Lead Time
<b>Ready-To-Ship US Warehouse</b>			
MSSTCS2-BRGR	Brown Green	USD 6,351.00	-
MSSTCS2-OAK	Oak	USD 6,351.00	-
MSSTCS2-WHIT	White	USD 6,351.00	-
<b>Ready-To-Ship EU Warehouse</b>			
MSSTCS2-GREY	Grey	USD 6,351.00	-



# STACKED STORAGE SYSTEM / SIDEBOARD - CONFIGURATION 3

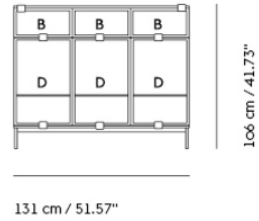

**Shipper Colli** 15  
**Gross Weight (kg)** 103.2  
**Net Weight (kg)** 73.105  
**Warranty period** 5 years

Pattern No.	Color	Contract Price	Lead Time
<b>Ready-To-Ship US Warehouse</b>			
MSSTCS3-BRGR	Brown Green	USD 3,460.00	-
MSSTCS3-OAK	Oak	USD 3,460.00	-
MSSTCS3-WHIT	White	USD 3,460.00	-
<b>Ready-To-Ship EU Warehouse</b>			
MSSTCS3-GREY	Grey	USD 3,460.00	-

# STACKED STORAGE SYSTEM / SIDEBBOARD - CONFIGURATION 4

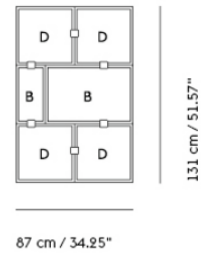

**Shipper Colli** 6  
**Gross Weight (kg)** 74.8  
**Net Weight (kg)** 55.995  
**Warranty period** 5 years

Pattern No.	Color	Contract Price	Lead Time
<b>Ready-To-Ship US Warehouse</b>			
MSSTCS4-BRGR	Brown Green	USD 2,046.00	-
MSSTCS4-OAK	Oak	USD 2,046.00	-
MSSTCS4-WHIT	White	USD 2,046.00	-
<b>Ready-To-Ship EU Warehouse</b>			
MSSTCS4-GREY	Grey	USD 2,046.00	-

# STACKED STORAGE SYSTEM / SIDEBBOARD - CONFIGURATION 5

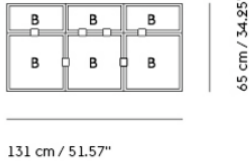

- Shipper Colli 6
- Gross Weight (kg) 64.65
- Net Weight (kg) 46.815
- Please note This is a wall-mounted configuration
- Warranty period 5 years

Pattern No.	Color	Contract Price	Lead Time
<b>Ready-To-Ship US Warehouse</b>			
MSSTCS5-BRGR	Brown Green	USD 1,731.00	-
MSSTCS5-OAK	Oak	USD 1,731.00	-
MSSTCS5-WHIT	White	USD 1,731.00	-
<b>Ready-To-Ship EU Warehouse</b>			
MSSTCS5-GREY	Grey	USD 1,731.00	-

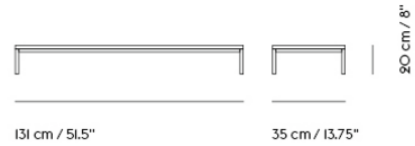

**Shipper Colli** 1  
**Gross Weight (kg)** 15.5  
**Net Weight (kg)** 12.5  
**Warranty period** 5 years

Pattern No.	Color	Contract Price	Lead Time
<b>Ready-To-Ship US Warehouse</b>			
MSSTP-MBLU	Midnight Blue ***	USD 503.00	-
MSSTP-OAK	Oak ***	USD 503.00	-
MSSTP-WHIT	White	USD 503.00	-

# STILL CAFÉ TABLE

FOR MORE INFORMATION,  
EXPLORE BELOW

- ↗ [Product Fact Sheet](#)
- ↗ [Images](#)
- ↗ [Architect Files](#)
- ↗ [Assembly Instructions](#)
- ↗ [Product Declaration](#)

**STILL CAFÉ TABLE / 75 X 65 H: 73 CM / 29.5 X 25.6 H: 28.7"**

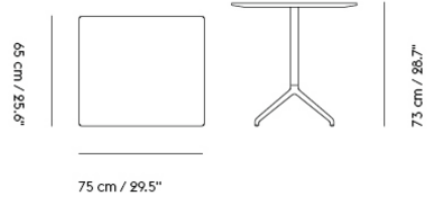

Shipper Colli	2
Gross Weight (kg)	18.3
Net Weight (kg)	13.352
Base color options	Black, White
Warranty Period	10 years

Pattern No.	Color	Contract Price	Lead Time
<b>Ready-To-Ship US Warehouse</b>			
MSTLCTR302629N-BLCK-BLCK	Black Nanolaminate/Anthracite Black	USD 923.00	-
MSTLCTR302629N-WHIT-BLCK	Black Nanolaminate/White	USD 923.00	-
MSTLCTR302629N-BLCK-WHIT	White Nanolaminate/Anthracite Black	USD 923.00	-
MSTLCTR302629N-WHIT-WHIT	White Nanolaminate/White	USD 923.00	-
<b>Made-To-Order</b>			
MSTLCTR302629O-BLCK-BLCK	Black Linoleum/Anthracite Black	USD 923.00	-
MSTLCTR302629O-WHIT-BLCK	Black Linoleum/White	USD 923.00	-

**STILL CAFÉ TABLE / 75 X 65 H: 95 CM / 29.5 X 25.6 H: 37.4"**

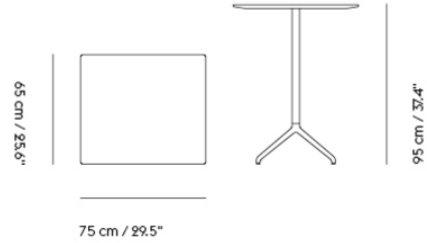

**Shipper Colli** 2  
**Gross Weight (kg)** 18.7  
**Net Weight (kg)** 13.848  
**Base color options** White, Black  
**Warranty Period** 10 years

Pattern No.	Color	Contract Price	Lead Time
<b>Made-To-Order</b>			
MSTLCTR3026380-BLCK-BLCK	Black Linoleum/Anthracite Black	USD 975.00	-
MSTLCTR3026380-WHIT-BLCK	Black Linoleum/White	USD 975.00	-
<b>Made-To-Order</b>			
MSTLCTR302638N-BLCK-BLCK	Black Nanolaminate/Anthracite Black	USD 975.00	-
MSTLCTR302638N-WHIT-BLCK	Black Nanolaminate/White	USD 975.00	-
MSTLCTR302638N-BLCK-WHIT	White Nanolaminate/Anthracite Black	USD 975.00	-
MSTLCTR302638N-WHIT-WHIT	White Nanolaminate/White	USD 975.00	-

**STILL CAFÉ TABLE / 75 X 65 H: 105 CM / 29.5 X 25.6 H: 41.3"**

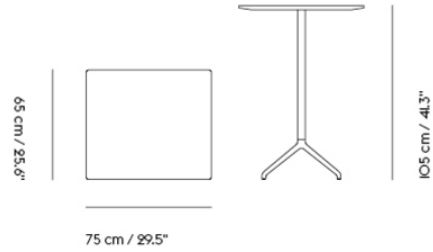

- Shipper Colli 2
- Gross Weight (kg) 19.05
- Net Weight (kg) 14.198
- Base color options White, Black
- Warranty Period 10 years

Pattern No.	Color	Contract Price	Lead Time
<b>Ready-To-Ship US Warehouse</b>			
MSTLCTR302641N-BLCK-BLCK	Black Nanolaminate/Anthracite Black	USD 975.00	-
MSTLCTR302641N-WHIT-BLCK	Black Nanolaminate/White	USD 975.00	-
MSTLCTR302641N-BLCK-WHIT	White Nanolaminate/Anthracite Black	USD 975.00	-
MSTLCTR302641N-WHIT-WHIT	White Nanolaminate/White	USD 975.00	-
<b>Made-To-Order</b>			
MSTLCTR302641O-BLCK-BLCK	Black Linoleum/Anthracite Black	USD 975.00	-
MSTLCTR302641O-WHIT-BLCK	Black Linoleum/White	USD 975.00	-



# STILL CAFÉ TABLE / Ø 75 H: 73 CM / Ø 29.5 H: 28.7"

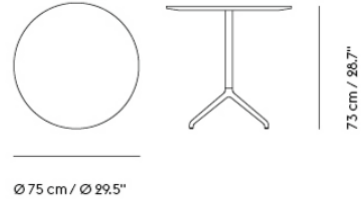

Shipper Colli	2
Gross Weight (kg)	17.1
Net Weight (kg)	12.152
Base color options	Black, White
Warranty Period	10 years

Pattern No.	Color	Contract Price	Lead Time
<b>Ready-To-Ship US Warehouse</b>			
MSTLCTO3029N-BLCK-BLCK	Black Nanolaminate/Anthracite Black	USD 923.00	-
MSTLCTO3029N-WHIT-BLCK	Black Nanolaminate/White	USD 923.00	-
MSTLCTO3029N-BLCK-WHIT	White Nanolaminate/Anthracite Black	USD 923.00	-
MSTLCTO3029N-WHIT-WHIT	White Nanolaminate/White	USD 923.00	-
<b>Made-To-Order</b>			
MSTLCTO3029O-BLCK-BLCK	Black Linoleum/Anthracite Black	USD 923.00	-
MSTLCTO3029O-WHIT-BLCK	Black Linoleum/White	USD 923.00	-

**STILL CAFÉ TABLE / Ø 75 H: 95 CM / Ø 29.5 H: 37.4"**

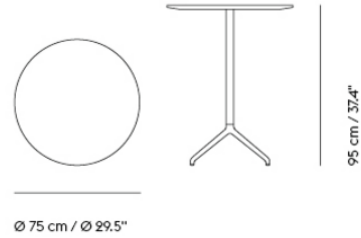

<b>Shipper Colli</b>	2
<b>Gross Weight (kg)</b>	17.5
<b>Net Weight (kg)</b>	12.648
<b>Base color options</b>	Black, White
<b>Warranty Period</b>	10 years

Pattern No.	Color	Contract Price	Lead Time
<b>Made-To-Order</b>			
MSTLCTO30380-BLCK-BLCK	Black Linoleum/Anthracite Black	USD 975.00	-
MSTLCTO30380-WHIT-BLCK	Black Linoleum/White	USD 975.00	-
<b>Made-To-Order</b>			
MSTLCTO3038N-BLCK-BLCK	Black Nanolaminate/Anthracite Black	USD 975.00	-
MSTLCTO3038N-WHIT-BLCK	Black Nanolaminate/White	USD 975.00	-
MSTLCTO3038N-BLCK-WHIT	White Nanolaminate/Anthracite Black	USD 975.00	-
MSTLCTO3038N-WHIT-WHIT	White Nanolaminate/White	USD 975.00	-

# STILL CAFÉ TABLE / Ø 75 H: 105 CM / Ø 29.5 H: 41.3"

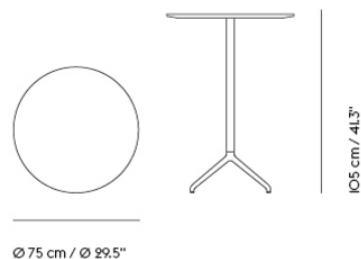

Shipper Colli	2
Gross Weight (kg)	17.85
Net Weight (kg)	12.998
Base color options	Black, White
Warranty Period	10 years

Pattern No.	Color	Contract Price	Lead Time
<b>Ready-To-Ship US Warehouse</b>			
MSTLCTO3041N-BLCK-BLCK	Black Nanolaminate/Anthracite Black	USD 975.00	-
MSTLCTO3041N-WHIT-BLCK	Black Nanolaminate/White	USD 975.00	-
MSTLCTO3041N-BLCK-WHIT	White Nanolaminate/Anthracite Black	USD 975.00	-
MSTLCTO3041N-WHIT-WHIT	White Nanolaminate/White	USD 975.00	-
<b>Made-To-Order</b>			
MSTLCTO3041O-BLCK-BLCK	Black Linoleum/Anthracite Black	USD 975.00	-
MSTLCTO3041O-WHIT-BLCK	Black Linoleum/White	USD 975.00	-

**STILL CAFÉ TABLE / Ø 65 H: 73 CM / Ø 25.6 H: 28.7"**

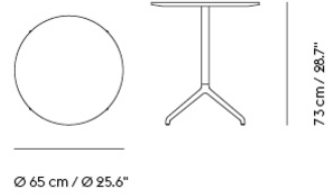

**Shipper Colli** 2  
**Gross Weight (kg)** 14.7  
**Net Weight (kg)** 10.152  
**Base color options** Black, White  
**Warranty Period** 10 years

Pattern No.	Color	Contract Price	Lead Time
<b>Made-To-Order</b>			
MSTLCTO26290-BLCK-BLCK	Black Linoleum/Anthracite Black	USD 923.00	-
MSTLCTO26290-WHIT-BLCK	Black Linoleum/White	USD 923.00	-
<b>Made-To-Order</b>			
MSTLCTO2629N-BLCK-BLCK	Black Nanolaminate/Anthracite Black	USD 923.00	-
MSTLCTO2629N-WHIT-BLCK	Black Nanolaminate/White	USD 923.00	-
MSTLCTO2629N-BLCK-WHIT	White Nanolaminate/Anthracite Black	USD 923.00	-
MSTLCTO2629N-WHIT-WHIT	White Nanolaminate/White	USD 923.00	-

**STILL CAFÉ TABLE / Ø 65 H: 95 CM / Ø 25.6 H: 37.4"**

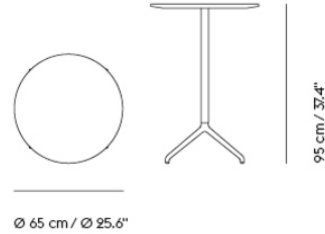

Shipper Colli	2
Gross Weight (kg)	15.1
Net Weight (kg)	10.648
Base color options	Black, White
Warranty Period	10 years

Pattern No.	Color	Contract Price	Lead Time
<b>Made-To-Order</b>			
MSTLCTO26380-BLCK-BLCK	Black Linoleum/Anthracite Black	USD 975.00	-
MSTLCTO26380-WHIT-BLCK	Black Linoleum/White	USD 975.00	-
<b>Made-To-Order</b>			
MSTLCTO2638N-BLCK-BLCK	Black Nanolaminate/Anthracite Black	USD 975.00	-
MSTLCTO2638N-WHIT-BLCK	Black Nanolaminate/White	USD 975.00	-
MSTLCTO2638N-BLCK-WHIT	White Nanolaminate/Anthracite Black	USD 975.00	-
MSTLCTO2638N-WHIT-WHIT	White Nanolaminate/White	USD 975.00	-

**STILL CAFÉ TABLE / Ø 65 H: 105 CM / Ø 25.6 H: 41.3"**

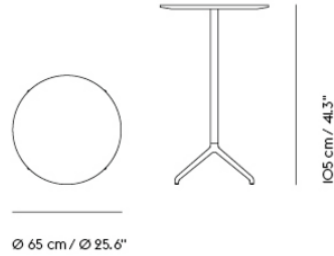

- Shipper Colli 2
- Gross Weight (kg) 15.45
- Net Weight (kg) 10.998
- Base color options Black, White
- Warranty Period 10 years

Pattern No.	Color	Contract Price	Lead Time
<b>Made-To-Order</b>			
MSTLCTO2641O-BLCK-BLCK	Black Linoleum/Anthracite Black	USD 975.00	-
MSTLCTO2641O-WHIT-BLCK	Black Linoleum/White	USD 975.00	-
<b>Made-To-Order</b>			
MSTLCTO2641N-BLCK-BLCK	Black Nanolaminate/Anthracite Black	USD 975.00	-
MSTLCTO2641N-WHIT-BLCK	Black Nanolaminate/White	USD 975.00	-
MSTLCTO2641N-BLCK-WHIT	White Nanolaminate/Anthracite Black	USD 975.00	-
MSTLCTO2641N-WHIT-WHIT	White Nanolaminate/White	USD 975.00	-

# VISU CHAIR SERIES

**FOR MORE INFORMATION,  
EXPLORE BELOW**

- ↗ [Product Fact Sheet](#)
- ↗ [Images](#)
- ↗ [Architect Files](#)
- ↗ [Assembly Instructions](#)
- ↗ [Product Declaration](#)
- ↗ [Product Configurator](#)

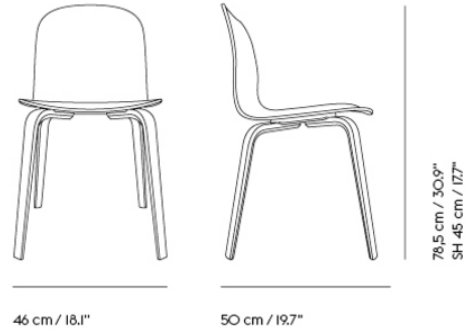

<b>Shipper Colli</b>	1
<b>Gross Weight (kg)</b>	10.2
<b>Net Weight (kg)</b>	4.6125
<b>Base color options</b>	Black, Dark Green, Dusty Green, Grey, Midnight Blue, Oak, Sand or Tan Rose
<b>Warranty Period</b>	5 years

Pattern No.	Color	Contract Price	Lead Time
-------------	-------	----------------	-----------

**Ready-To-Ship US Warehouse**

MVISCWODW-BLCK-BLCK	Black/Black	USD 467.00	-
MVISCWODW-DGRN-DGRN	Dusty Green/Dusty Green	USD 467.00	-
MVISCWODW-OAK-OAK	Oak/Oak	USD 467.00	-
MVISCWODW-OAK-WHIT	White/Oak	USD 467.00	-

**Ready-To-Ship EU Warehouse**

MVISCWODW-DKGN-DKGN	Dark Green/Dark Green	USD 467.00	-
MVISCWODW-MBLU-MBLU	Midnight Blue/Midnight Blue	USD 467.00	-
MVISCWODW-SAND-SAND	Sand/Sand	USD 467.00	-
MVISCWODW-TROS-TROS	Tan Rose/Tan Rose	USD 467.00	-

**Extras**

MGLDVWDFG4	Felt glides for Visu Wood Base (4 pcs per pack) - Grey	USD 21.00	-
MGLDVWDFB4	Felt glides for Visu Wood Base (4 pcs per pack) - Black	USD 21.00	-
MGLDVWDPB4	Plastic Glides for Visu Wood Base (4 pcs per pack) - Black	USD 21.00	-
MLEAKIT	Leather care set for Refine Leather	USD 27.00	-





<b>Shipper Colli</b>	1
<b>Gross Weight (kg)</b>	13.5
<b>Net Weight (kg)</b>	5.75
<b>Base color options</b>	Black, Chrome or Grey
<b>Stacking information</b>	Stacking on Trolley: Without upholstery: 17 - With upholstery: 15. Stacking on floor: Without upholstery: 15 - With upholstery: 10.
<b>Warranty Period</b>	10 years

Pattern No.	Color	Contract Price	Lead Time
<b>Ready-To-Ship EU Warehouse</b>			
MVISCTUBW-BLCK-BLCK	Black/Black	USD 394.00	-
<b>Extras</b>			
MCHVST	Chair Hanger for Visu Chair (Sled + Tube base)	USD 93.00	>MOQ: 50 13-15 weeks

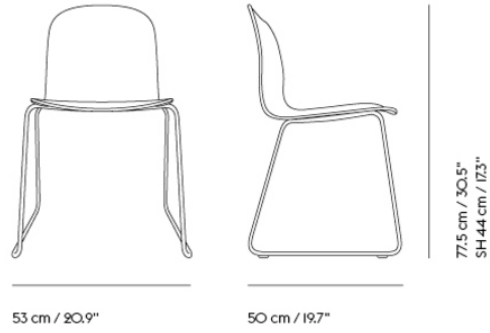

<b>Shipper Colli</b>	1
<b>Gross Weight (kg)</b>	13.5
<b>Net Weight (kg)</b>	5.75
<b>Base color options</b>	Black, Grey or White
<b>Stacking information</b>	Stacking on Trolley: Without upholstery: 17 - With upholstery: 15. Stacking on floor: Without upholstery: 15 - With upholstery: 10
<b>Warranty Period</b>	10 years

Pattern No.	Color	Contract Price	Lead Time
-------------	-------	----------------	-----------

**Ready-To-Ship US Warehouse**

MVISCSLDW-BLCK-BLCK	Black/Black	USD 394.00	-
MVISCSLDW-WHIT-WHIT	White/White ***	USD 394.00	-

**Extras**

MGLDFVSDFT1	Felt Glides for Fiber and Visu with Sled Base (1 pc per pack)	USD 6.00	-
MLDVSLD	Linking Device for Visu Chair Sled Base	USD 48.00	>MOQ: 8 13-15 weeks
MCHVST	Chair Hanger for Visu Chair (Sled + Tube base)	USD 93.00	>MOQ: 50 13-15 weeks

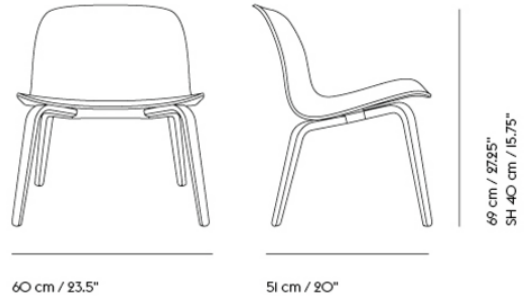

Shipper Colli	1
Gross Weight (kg)	11.5
Net Weight (kg)	9.224
Base color options	Black, Dusty Green, Grey or Oak
Warranty Period	5 years

Pattern No.	Color	Contract Price	Lead Time
<b>Ready-To-Ship US Warehouse</b>			
MVISLW-BLCK-BLCK	Black/Black	USD 667.00	-
MVISLW-GREY-GREY	Grey/Grey - PU Lacquer	USD 667.00	-
MVISLW-OAK-OAK	Oak/Oak	USD 667.00	-
MVISLU-OAK-M155991	Fiord 991/Oak	USD 1,024.00	-
MVISLU-GREY-M4586108	Re-wool 108/ Grey	USD 1,024.00	-
MVISLU-OAK-M136COGN	Refine Leather Cognac/Oak	USD 1,675.00	-
<b>Ready-To-Ship EU Warehouse</b>			
MVISLW-DGRN-DGRN	Dusty Green/Dusty Green	USD 667.00	-
<b>Extras</b>			
MGLDVWDFG4	Felt glides for Visu Wood Base (4 pcs per pack) - Grey	USD 21.00	-
MGLDVWDPB4	Plastic Glides for Visu Wood Base (4 pcs per pack) - Black	USD 21.00	-
MLEAKIT	Leather care set for Refine Leather	USD 27.00	-

# VISU COUNTER STOOL WOOD BASE - 65 CM / 25.6"

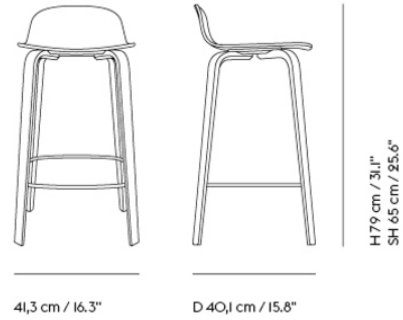

Shipper Colli	1
Gross Weight (kg)	5.6
Net Weight (kg)	4.08
Base color options	Black, Dark Green, Grey, Oak or Tan Rose
Warranty Period	5 years

Pattern No.	Color	Contract Price	Lead Time
<b>Ready-To-Ship US Warehouse</b>			
MVISSTCW-BLCK-BLCK	Black/Black	USD 719.00	-
MVISSTCW-GREY-GREY	Grey/Grey	USD 719.00	-
MVISSTCW-OAK-OAK	Oak/Oak	USD 719.00	-
<b>Ready-To-Ship EU Warehouse</b>			
MVISSTCW-OAK-WHIT	White/Oak	USD 719.00	-
<b>Extras</b>			
MGLDVWDFG4	Felt glides for Visu Wood Base (4 pcs per pack) - Grey	USD 21.00	-
MGLDVWDPB4	Plastic Glides for Visu Wood Base (4 pcs per pack) - Black	USD 21.00	-
MLEAKIT	Leather care set for Refine Leather	USD 27.00	-

**VISU BAR STOOL WOOD BASE - 75 CM / 29.5"**



<b>Shipper Colli</b>	1
<b>Gross Weight (kg)</b>	5.7
<b>Net Weight (kg)</b>	4.18
<b>Base color options</b>	Black, Dark Green, Grey, Oak or Tan Rose
<b>Warranty Period</b>	5 years

Pattern No.	Color	Contract Price	Lead Time
<b>Ready-To-Ship US Warehouse</b>			
MVISSTBW-BLCK-BLCK	Black/Black	USD 719.00	-
MVISSTBW-GREY-GREY	Grey/Grey	USD 719.00	-
MVISSTBW-OAK-OAK	Oak/Oak ***	USD 719.00	-
MVISSTBW-TROS-TROS	Tan Rose/Tan Rose	USD 719.00	-
<b>Ready-To-Ship EU Warehouse</b>			
MVISSTBW-OAK-WHIT	White/Oak	USD 719.00	-
<b>Extras</b>			
MGLDVWDFG4	Felt glides for Visu Wood Base (4 pcs per pack) - Grey	USD 21.00	-
MGLDVWDPB4	Plastic Glides for Visu Wood Base (4 pcs per pack) - Black	USD 21.00	-
MLEAKIT	Leather care set for Refine Leather	USD 27.00	-

# COVER AND VISU CHAIR TRANSPORT TROLLEY

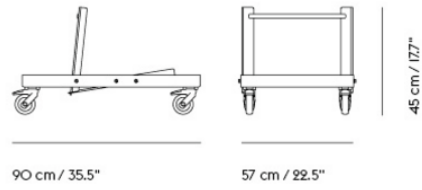

<b>Shipper Colli</b>	1
<b>Gross Weight (kg)</b>	22
<b>Net Weight (kg)</b>	21.5
<b>Please note</b>	This transport trolley can be used for Visu Chair Tube Base, Visu Chair Sled Base and Cover Side Chair.
<b>Stacking information</b>	Cover Side Chair (10 pcs.) / Visu Chair Sled Base (17 pcs.) / Visu Chair Tube Base (17 pcs.) / Visu Chair Sled Base w. Upholstery (15 pcs.) / Visu Chair Tube Base w. Upholstery (15 pcs)
<b>Warranty Period</b>	5 years

Pattern No.	Color	Contract Price	Lead Time
<b>Ready-To-Ship US Warehouse</b>			
MTTCV	Black	USD 971.00	-

# VISU CHAIR WOOD BASE & VISU LOUNGE CHAIR



78,5 cm / 31"  
SH 46 cm / 18"

46 cm / 18"

51 cm / 20"



69 cm / 27.25"  
SH 40 cm / 15.75"

60 cm / 23.5"

51 cm / 20"

## All Upholstery Variants

Description	Pattern No.	Upholstery Grades									
		A	B	C	E	R	T	U	V	W	
Visu Chair Wood Base	Upholstered Seat	M-VISC-WOD-U	719	786	849	881	933	1,101	1,045	1,416	1,570
Visu Lounge Chair	Upholstered Seat	M-VISL-U	919	1,024	1,101	1,150	1,626	1,675	1,675	2,361	2,515

### HOW TO CONFIGURE

Specify:

- Step 1) Choose variant
- Step 2) Choose base color
- Step 3) Choose textile
- Step 4) Choose textile color

### ORDER CODE EXAMPLE:

Visu Lounge Chair upholstered in beige Endure Leather

Variant: Visu Lounge Chair  
 Base color: Oak  
 Upholstery option: Endure Leather  
 Upholstery color: Beige  
 Final Pattern No: MVISLUOAKM137BEIG

### Base Color Options

Visu Chair - wood base:  
 OAK - Oak  
 BLCK - Black  
 GREY - Grey  
 DKGN - Dark Green  
 TROS - Tan Rose

Visu Lounge Chair - wood base:  
 OAK - Oak  
 BLCK - Black  
 GREY - Grey  
 DGRN - Dusty Green

### Upholstery Options

A	B	C	E	R	T	U	V	W
Ocean (M161)* Remix (M156)	Canvas (M153) Clara (M154) Colline (M5416) Fiord (M155) Grain (M12659) Manner (M12665) Re-Wool (4586) Sabi (M8404) Steelcut (M149) Steelcut Trio (M139)	Hallingdal (M146)	Acca (M12660) Balder (M152) Beck (M6376) Divina (M150) Divina MD (M147) Divina Melange (M135) Ecriture (M01767) Hearth (M12664) Planum (M5904) Twill Weave (M142)	Easy Leather (M141)	Refine Leather (M136)	Endure Leather (M137)	Grace Leather (M12374)	Allure Leather (M12375)

\*Notes:  
 \*Ocean: Color 3, 21, 32, 50, 52, 80 & 601

# VISU CHAIR TUBE & SLED BASE



78 cm / 30.75"  
SH 46 cm / 18"



78 cm / 30.75"  
SH 46 cm / 18"

53,5 cm / 21"

50 cm / 19.75"

53,5 cm/21"

48 cm / 19"

## All Variants

Description	Pattern No.	W1	Upholstery Grades					
			A	COM B	CIL C	E	R	
Visu Chair Tube Base	Wood Seat	M-VISC-TUB-W	394					
	Upholstered Seat	M-VISC-TUB-U		576	614	681	719	776
Visu Chair Tube Base w Linking Device	Wood Seat	M-VISC-TUB-W-LD	440					
	Upholstered Seat	M-VISC-TUB-U-LD		625	660	730	772	824
Visu Chair Sled Base	Wood Seat	M-VISC-SLD-W	394					
	Upholstered Seat	M-VISC-SLD-U		562	614	681	719	776
Visu Chair Sled Base w Linking Device	Wood Seat	M-VISC-SLD-W-LD	440					
	Upholstered Seat	M-VISC-SLD-U-LD		625	660	730	772	824

## HOW TO CONFIGURE

## ORDER CODE EXAMPLE:

Specify:

Visu Chair Black Sled Base upholstered in Divina Melange 277

- Step 1) Choose variant
- Step 2) Choose base color
- Step 3) Choose textile
- Step 4) Choose textile color

Variant: Visu Chair Sled Base  
 Base color: Black  
 Upholstery option: Endure Leather  
 Upholstery color: 277  
 Final Pattern No: M-VISC-SLD-U  
 M-VISC-SLD-U  
 BLCK  
 M135  
 277  
 MVISCSLDUBLCKM135277

### Base Color Options

### Shell Color Options

### When ordering wood shell version

Tube base  
 BLCK - Black  
 GREY - Grey  
 CHRO - Chrome

Tube base  
 OAK - Oak (W1)  
 BLCK - Black (W1)  
 GREY - Grey (W1)

Base and wood shell can be combined as follows  
 Tube Base  
 BLCK/BLCK - Black/Black Shell  
 GREY/GREY - Grey/Grey Shell  
 CHRO/OAK - Chrome/Oak Shell

Sled base  
 BLCK - Black  
 GREY - Grey  
 WHIT - White

Sled base  
 WHIT - White (W1)  
 BLCK - Black (W1)

Sled base  
 BLCK/BLCK - Black/Black Shell  
 GREY/GREY - Grey/Grey Shell  
 WHIT/WHIT - White/White Shell

### Upholstery Options

A	B	C	E	R
Ocean (M161)* Remix (M156)	Canvas (M153) Clara (M154) Colline (M5416) Fiord (M155) Grain (M12659) Manner (M12665) Re-Wool (4586) Sabi (M8404) Steelcut (M149) Steelcut Trio (M139)	Hallingdal (M146)	Acca (M12660) Balder (M152) Beck (M6376) Divina (M150) Divina MD (M147) Divina Melange (M135) Ecriture (M01767) Hearth (M12664) Planum (M5904) Twill Weave (M142)	Easy Leather (M141)

\*Notes:  
 \*Ocean: Color 3, 21, 32, 50, 52, 80 & 601



# VISU WIDE CHAIR WOOD & SWIVEL BASE

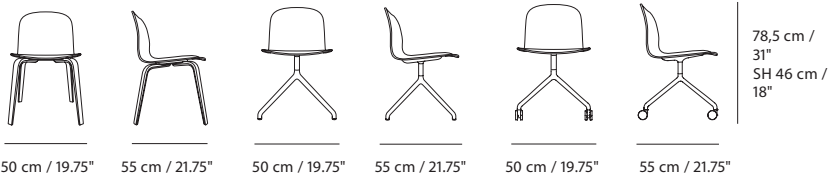

Wood base:  
Gross Weight (kg) 4.9  
Net Weight (kg) 4.6  
Warranty Period 5 years

Swivel base & Swivel base w/castors:  
Gross Weight (kg) 7.8  
Net Weight (kg) 7.6  
Warranty Period 5 years

## All Variants

			Upholstery Grades									
			COM			CIL		COL				
	Description	Pattern No.	W1	A	B	C	E	R	T	U	V	W
Visu Wide Chair Wood	Wood Seat	M-VISWC-WOD-W	541									
Base	Upholstered Seat	M-VISWC-WOD-U		807	881	933	971	1,024	1,150	1,206	1,836	2,046
Visu Wide Chair Swivel	Wood Seat	M-VISWC-SWB-W	702									
Base	Upholstered Seat	M-VISWC-SWB-U		971	1,101	1,101	1,150	1,255	1,311	1,360	2,046	2,256
Visu Wide Chair Swivel	Wood Seat	M-VISWC-SWR-W	776									
Base w. Return	Upholstered Seat	M-VISWC-SWR-U		1,045	1,150	1,206	1,206	1,311	1,311	1,416	2,046	2,256
Visu Wide Chair Swivel	Wood Seat	M-VISWC-SWC-W	776									
Base w. Castors	Upholstered Seat	M-VISWC-SWC-U		1,045	1,150	1,206	1,206	1,255	1,416	1,416	2,095	2,305

## HOW TO CONFIGURE

## ORDER CODE EXAMPLE:

Specify:

Visu Chair Black Sled Base upholstered in Divina Melange 277

Step 1) Choose Variant  
Step 2) Base color  
Step 3) Textile  
Step 4) Textile color

Variant: Visu Chair Sled Base  
Base Color: Black  
Upholstery option: Endure Leather  
Upholstery Color: 277  
Final Pattern No.: MVISCSLDUBLCKM135277

## Base Color Options

## Shell Color Options

## When ordering wood shell version

Swivel base & Swivel base w. Return  
BLCK - Black

OAK - Oak (W1)  
BLCK - Black (W1)

Base and Shell can be combined as follows  
Wood base  
OAK/OAK - Oak/Oak Shell  
BLCK/BLCK - Black/Black Shell

Swivel base w. Castors  
BLCK - Black with black castors

Wood base:  
OAK - Oak  
BLCK - Black

All Swivel bases  
BLCK/BLCK - Black/Black Shell  
BLCK/OAK - Black/Oak Shell

## Upholstery Options

A	B	C	E	R	T	U	V	W
Ocean (M161)* Remix (M156)	Canvas (M153) Clara (M154) Colline (M5416) Fiord (M155) Grain (M12659) Manner (M12665) Re-Wool (4586) Sabi (M8404) Steelcut (M149) Steelcut Trio (M139)	Hallingdal (M146)	Acca (M12660) Balder (M152) Beck (M6376) Divina (M150) Divina MD (M147) Divina Melange (M135) Ecriture (M01767) Hearth (M12664) Planum (M5904) Twill Weave (M142)	Easy Leather (M141)	Refine Leather (M136)	Endure Leather (M137)	Grace Leather (M12374)	Allure Leather (M12375)

\*Notes:  
Ocean - Color 3, 21, 32, 50, 52, 80 & 601



## All Upholstery Variants

Description	Pattern No.	Upholstery Grades									
		A	COM		CIL			COL			
			B	C	E	R	T	U	V	W	
Visu Counter Upholstered Seat	M-VISST-C-U	866	902	1,013	995	1,045	1,101	1,101	1,465	1,570	
Visu Bar Stool Upholstered Seat	M-VISST-B-U	866	902	1,013	995	1,045	1,101	1,101	1,465	1,570	

### HOW TO CONFIGURE

### ORDER CODE EXAMPLE:

<p>Specify:</p> <p>Step 1) Choose variant                  Step 2) Choose color                  Step 3) Choose Textile                  Step 4) Choose Textile color</p>	<p>Visu Counter Stool upholstered in beige Endure Leather</p> <p>Variant: Visu Counter Stool                  Base Color: Oak                  Upholstery option: Endure Leather                  Upholstery Color: Beige                  Final Pattern No: MVISSTCUOAKM137BEIG</p>
---	--

### Base Color Options

- OAK - Oak
- BLCK - Black
- GREY - Grey
- DKGN - Dark Green
- TROS - Tan Rose

### Upholstery Options

A	B	C	E	R	T	U	V	W
Ocean (M161)* Remix (M156)	Canvas (M153) Clara (M154) Colline (M5416) Fiord (M155) Grain (M12659) Manner (M12665) Re-Wool (4586) Sabi (M8404) Steelcut (M149) Steelcut Trio (M139)	Hallingdal (M146)	Acca (M12660) Balder (M152) Beck (M6376) Divina (M150) Divina MD (M147) Divina Melange (M135) Ecriture (M01767) Hearth (M12664) Planum (M5904) Twill Weave (M142)	Easy Leather (M141)	Refine Leather (M136)	Endure Leather (M137)	Grace Leather (M12374)	Allure Leather (M12375)

\*Notes:  
Ocean - Color 3, 21, 32, 50, 52, 80 & 601

# WORKSHOP SERIES

FOR MORE INFORMATION,  
EXPLORE BELOW

- ↗ [Product Fact Sheet](#)
- ↗ [Images](#)
- ↗ [Architect Files](#)
- ↗ [Assembly Instructions](#)
- ↗ [Product Declaration](#)

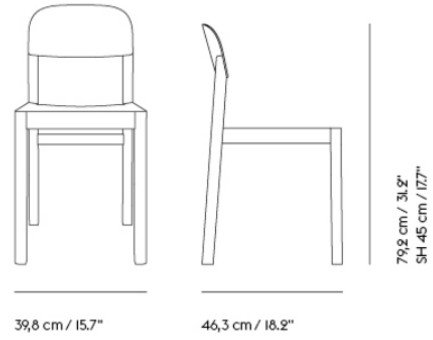

**Shipper Colli** I  
**Gross Weight (kg)** II  
**Net Weight (kg)** 5.095  
**Warranty Period** 5 years

Pattern No.	Color	Contract Price	Lead Time
<b>Ready-To-Ship US Warehouse</b>			
MWRKCW-BLCK	Black	USD 597.00	-
MWRKCW-OAK	Oak	USD 597.00	-
<b>Extras</b>			
MGLDNSWCFB4	Felt glides for Nerd Series and Workshop Chair and Bench (4 pcs per pack) - Black	USD 21.00	-
MGLDNSWCFG4	Felt glides for Nerd Series and Workshop Chair and Bench (4 pcs per pack) - Grey	USD 21.00	-

# WORKSHOP TABLE / 130 X 65 CM / 51 X 25.5"

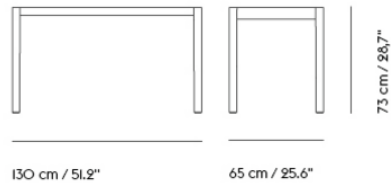
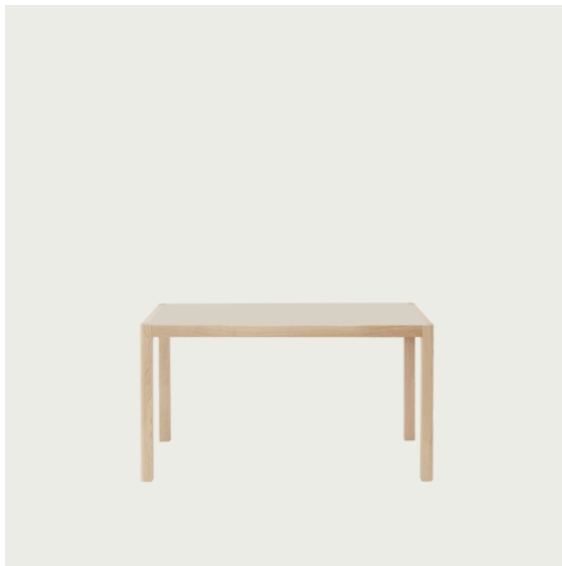

**Shipper Colli** 1  
**Gross Weight (kg)** 26.25  
**Net Weight (kg)** 22.5  
**Warranty Period** 10 years

Pattern No.	Color	Contract Price	Lead Time
<b>Ready-To-Ship US Warehouse</b>			
MWRKDT5126-BLCK-BLCK	Black Linoleum/Black	USD 2,256.00	-
MWRKDT5126-WMGY-OAK	Warm Grey Linoleum/Oak	USD 2,256.00	-

# WORKSHOP TABLE / 140 X 92 CM / 55.1 X 36.2"

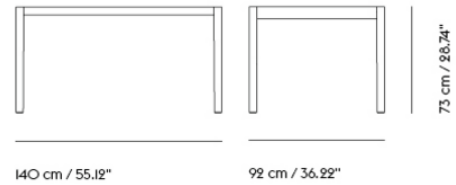

**Shipper Colli** 1  
**Gross Weight (kg)** 30  
**Net Weight (kg)** 25.95  
**Warranty Period** 10 years

Pattern No.	Color	Contract Price	Lead Time
<b>Ready-To-Ship EU Warehouse</b>			
MWRKDT5536-OAK	Oak Veneer/Oak	USD 2,781.00	-
MWRKDT5536-BLCK-BLCK	Black Linoleum/Black	USD 2,571.00	-
MWRKDT5536-WMGY-OAK	Warm Grey Linoleum/Oak	USD 2,571.00	-

# WORKSHOP TABLE / 200 X 92 CM / 78.7 X 36.2"

492

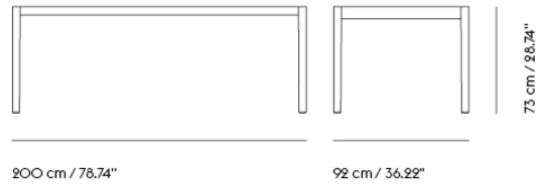

**Shipper Colli** 1  
**Gross Weight (kg)** 44  
**Net Weight (kg)** 39.55  
**Warranty Period** 10 years

Pattern No.	Color	Contract Price	Lead Time
<b>Ready-To-Ship EU Warehouse</b>			
MWRKDT7836-OAK	Oak Veneer/Oak	USD 3,516.00	-
MWRKDT7836-BLCK-BLCK	Black Linoleum/Black	USD 3,306.00	-
MWRKDT7836-WMGY-OAK	Warm Grey Linoleum/Oak	USD 3,306.00	-

**WORKSHOP COFFEE TABLE / 120 X 43 CM  
/ 47.2" X 16.9"**

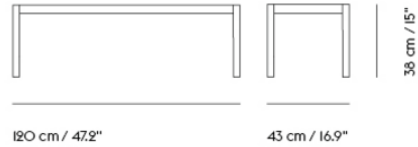

Shipper Colli 1  
 Gross Weight (kg) 10.5  
 Net Weight (kg) 8.46  
 Warranty Period 5 years

Pattern No.	Color	Contract Price	Lead Time
<b>Ready-To-Ship US Warehouse</b>			
MWRKCT4717-BOAK	Black	USD 866.00	-
MWRKCT4717-OAK	Oak Veneer/Oak	USD 866.00	-
MWRKCT4717-BLCK	Black Linoleum/Black	USD 845.00	-
MWRKCT4717-WMGY	Warm Grey Linoleum/Oak	USD 845.00	-



**WORKSHOP COFFEE TABLE / 86 X 86 CM / 33.9" X 33.9"**

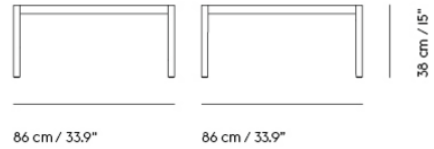

Shipper Colli 1  
 Gross Weight (kg) 11.8  
 Net Weight (kg) 9.22  
 Warranty Period 10 years

Pattern No.	Color	Contract Price	Lead Time
<b>Ready-To-Ship US Warehouse</b>			
MWRKCT3434-BOAK	Black	USD 1,101.00	-
MWRKCT3434-OAK	Oak Veneer/Oak	USD 1,101.00	-
MWRKCT3434-BLCK	Black Linoleum/Black	USD 1,028.00	-
MWRKCT3434-WMGY	Warm Grey Linoleum/Oak	USD 1,028.00	-

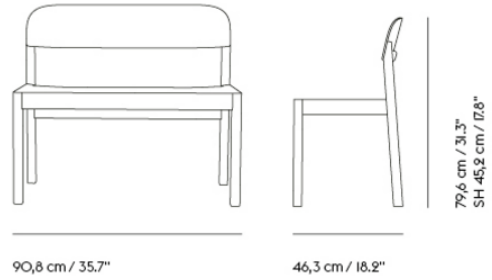

**Shipper Colli** 1  
**Gross Weight (kg)** 12.76  
**Net Weight (kg)** 9.49  
**Warranty Period** 5 years

Pattern No.	Color	Contract Price	Lead Time
<b>Ready-To-Ship EU Warehouse</b>			
MWRKBW-BLCK	Black	USD 1,360.00	-
MWRKBW-OAK	Oak	USD 1,360.00	-
<b>Extras</b>			
MGLDNSWCFB4	Felt glides for Nerd Series and Workshop Chair and Bench (4 pcs per pack) - Black	USD 21.00	-
MGLDNSWCFG4	Felt glides for Nerd Series and Workshop Chair and Bench (4 pcs per pack) - Grey	USD 21.00	-

# WRAP LOUNGE CHAIR

FOR MORE INFORMATION,  
EXPLORE BELOW

- ↗ [Product Fact Sheet](#)
- ↗ [Images](#)
- ↗ [Architect Files](#)
- ↗ [Product Declaration](#)
- ↗ [Product Configurator](#)

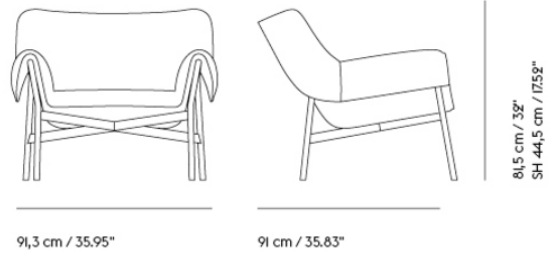

**Shipper Colli** 1  
**Gross Weight (kg)** 45  
**Net Weight (kg)** 40  
**Base color options** Grey or Black  
**Warranty Period** 10 years

Pattern No.	Color	Contract Price	Lead Time
<b>Ready-To-Ship US Warehouse</b>			
MWRPLC-BLCK-M8404151	Sabi 151/Black ***	USD 3,096.00	-
MWRPLC-GREY-M10767240	Ecriture 240/Grey	USD 3,355.00	-



WRAP LOUNGE CHAIR

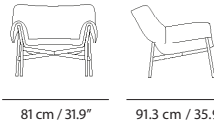

91 cm /  
35.8"  
SH 44.5 cm /  
17.5"

81 cm / 31.9"

91.3 cm / 35.9"

Tube Base  
Shipper Coll: 1  
Gross Weight (kg): 45  
Net Weight (kg): 40  
Warranty Period: 10 years

## All Upholstery Variants

All Variants

	Pattern No.	Upholstery Grades			
		A	COM	CIL	E
Wrap Lounge Chair	MWRPLC	2,676	3,096	3,201	3,355

### HOW TO CONFIGURE

Specify:

- Step 1: Choose variant
- Step 2: Choose base color
- Step 3: Choose textile
- Step 4: Choose textile color

### ORDER CODE EXAMPLE

Oslo Lounge Chair Tube Base in Colline 227

Variant	Wrap Lounge Chair
Base Color	Black
Textile	Colline
Textile Color	227
Final Pattern No:	MWRPLCBLCKM5416227

### Base Finish Options

- BLCK - Black
- GREY - Grey

### UPHOLSTERY OPTIONS

A	B	C	E
Ocean (M161)* Remix (M156)	Canvas (M153) Clara (M154) Fiord (M155) Grain (M12659) Manner (M12665) Re-Wool (M4586) Sabi (M8404) Steelcut (M149) Steelcut Trio (M139)	Hallingdal (M146)	Acca (M12660) Beck (M6376) Divina (M150) Divina MD (M147) Divina Melange (M135) Ecriture (M10767) Hearth (M12664) Twill Weave (M142) Vidar (M158)

\*Notes:  
Ocean - Color 3, 21, 32, 50, 52, 80 & 601

# LIGHTING

# AMBIT LAMP SERIES

FOR MORE INFORMATION,  
EXPLORE BELOW

- ↗ [Product Fact Sheet](#)
- ↗ [Images](#)
- ↗ [Architect Files](#)
- ↗ [Assembly Instructions](#)
- ↗ [Product Declaration](#)
- ↗ [Lighting Files](#)

# AMBIT PENDANT LAMP / Ø 16,5 CM / 6.5"

501



Shipper Colli	1
Gross Weight (kg)	1.0002
Net Weight (kg)	0.69
Bulb included	EU version: yes, US version: no
Warranty Period	5 years

Pattern No.	Color	Contract Price	Lead Time
<b>Ready-To-Ship US Warehouse</b>			
MAMBPDLP06-BLCK	Black	USD 299.00	-
MAMBPDLP06-DGRN	Dusty Green	USD 299.00	-
MAMBPDLP06-GREY	Grey	USD 299.00	-
MAMBPDLP06-LTBU	Light Blue	USD 299.00	-
MAMBPDLP06-TAUP	Taupe	USD 299.00	-
MAMBPDLP06-WHIT	White	USD 299.00	-
<b>Extras</b>			
MLPCAPL	Ceiling Cap - White	USD 28.00	-



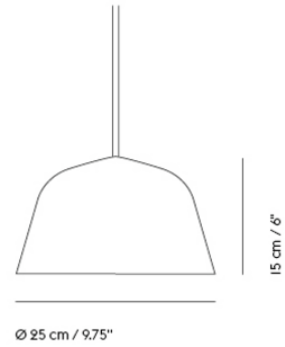

**Shipper Colli** 1  
**Gross Weight (kg)** 1.1092  
**Net Weight (kg)** 0.7  
**Bulb included** No  
**Warranty Period** 5 years

Pattern No.	Color	Contract Price	Lead Time
<b>Ready-To-Ship US Warehouse</b>			
MAMBPDLP09-BLCK	Black	USD 419.00	-
MAMBPDLP09-DGRN	Dusty Green	USD 419.00	-
MAMBPDLP09-GREY	Grey	USD 419.00	-
MAMBPDLP09-LTBU	Light Blue	USD 419.00	-
MAMBPDLP09-ROS	Rose	USD 419.00	-
MAMBPDLP09-TAUP	Taupe	USD 419.00	-
MAMBPDLP09-WHIT	White	USD 419.00	-
<b>Extras</b>			
MLPCAPL	Ceiling Cap - White	USD 28.00	-

# AMBIT PENDANT LAMP / Ø 40 CM / 15.75"

503

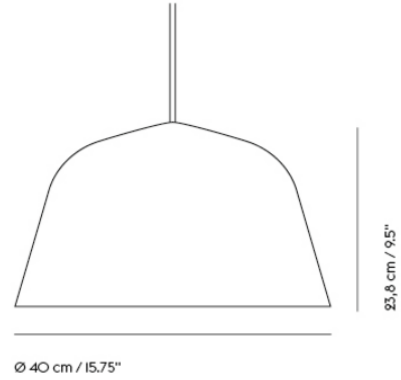

Shipper Colli	1
Gross Weight (kg)	2.9002
Net Weight (kg)	1.53
Bulb included	No
Warranty Period	5 years

Pattern No.	Color	Contract Price	Lead Time
<b>Ready-To-Ship US Warehouse</b>			
MAMBPDLP15-BLCK	Black	USD 671.00	-
MAMBPDLP15-DGRN	Dusty Green	USD 671.00	-
MAMBPDLP15-GREY	Grey	USD 671.00	-
MAMBPDLP15-LTBU	Light Blue	USD 671.00	-
MAMBPDLP15-ROS	Rose	USD 671.00	-
MAMBPDLP15-TAUP	Taupe	USD 671.00	-
MAMBPDLP15-WHIT	White	USD 671.00	-
<b>Extras</b>			
MLPCAPL	Ceiling Cap - White	USD 28.00	-

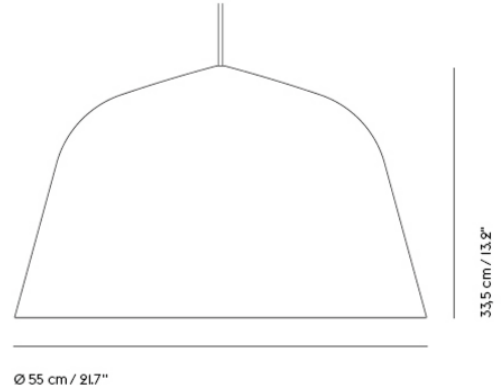

Shipper Colli	1
Gross Weight (kg)	5.585
Net Weight (kg)	2.7
Bulb included	No
Warranty Period	5 years

Pattern No.	Color	Contract Price	Lead Time
<b>Ready-To-Ship US Warehouse</b>			
MAMBPDLP22-BLCK	Black	USD 1,007.00	-
MAMBPDLP22-DGRN	Dusty Green	USD 1,007.00	-
MAMBPDLP22-GREY	Grey	USD 1,007.00	-
MAMBPDLP22-LTBU	Light Blue	USD 1,007.00	-
MAMBPDLP22-TAUP	Taupe	USD 1,007.00	-
MAMBPDLP22-WHIT	White	USD 1,007.00	-
<b>Extras</b>			
MLPCAPL	Ceiling Cap - White	USD 28.00	-

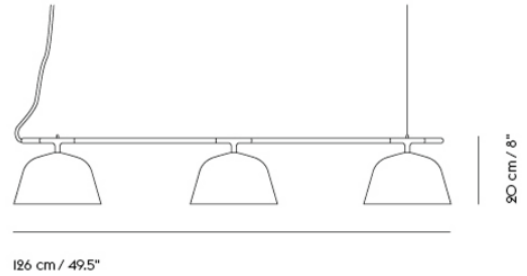

**Shipper Colli** 1  
**Gross Weight (kg)** 4  
**Net Weight (kg)** 2  
**Bulb included** No  
**Warranty Period** 5 years

Pattern No.	Color	Contract Price	Lead Time
<b>Ready-To-Ship US Warehouse</b>			
MAMBRALP-BLCK	Black	USD 1,521.00	-
MAMBRALP-GREY	Grey	USD 1,521.00	-
MAMBRALP-TAUP	Taupe	USD 1,521.00	-
MAMBRALP-WHIT	White	USD 1,521.00	-

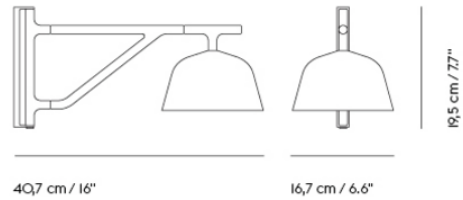

Shipper Colli	1
Gross Weight (kg)	1.734
Net Weight (kg)	1.04
Bulb included	Yes. Not applicable for North America,
Warranty Period	5 years

Pattern No.	Color	Contract Price	Lead Time
<b>Ready-To-Ship US Warehouse</b>			
MAMBWLLP-BLCK	Black	USD 639.00	-
MAMBWLLP-GREY	Grey	USD 639.00	-
MAMBWLLP-TAUP	Taupe	USD 639.00	-
MAMBWLLP-WHIT	White	USD 639.00	-

# BEAM TABLE LAMP

FOR MORE INFORMATION,  
EXPLORE BELOW

- ↗ [Product Fact Sheet](#)
- ↗ [Images](#)
- ↗ [Architect Files](#)
- ↗ [Assembly Instructions](#)
- ↗ [Product Declaration](#)
- ↗ [Lighting Files](#)

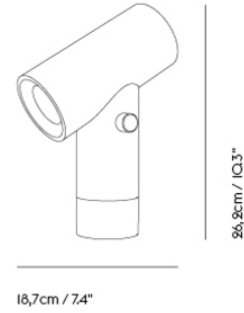

Shipper Colli	1
Gross Weight (kg)	1.72
Net Weight (kg)	1.234
Bulb included	Yes. Integrated non-replaceable LED
Warranty Period	5 years

Pattern No.	Color	Contract Price	Lead Time
<b>Ready-To-Ship US Warehouse</b>			
MBEATBLP-ALUM	Aluminum	USD 492.00	-
MBEATBLP-BLCK	Black	USD 492.00	-
MBEATBLP-GREN	Green	USD 492.00	-
MBEATBLP-UMBR	Umber	USD 492.00	-

# CONTROL TABLE LAMP

FOR MORE INFORMATION,  
EXPLORE BELOW

- ↗ [Product Fact Sheet](#)
- ↗ [Images](#)
- ↗ [Architect Files](#)
- ↗ [Assembly Instructions](#)
- ↗ [Product Declaration](#)
- ↗ [Lighting Files](#)



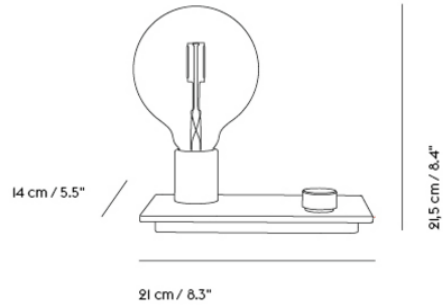

**Shipper Colli** 1  
**Gross Weight (kg)** 1.4055  
**Net Weight (kg)** 0.9125  
**Bulb included** Yes  
**Warranty Period** 5 years

Pattern No.	Color	Contract Price	Lead Time
<b>Ready-To-Ship US Warehouse</b>			
MCONTBLP-BLCK	Black	USD 299.00	-
MCONTBLP-GREY	Grey	USD 299.00	-
MCONTBLP-RED	Red	USD 299.00	-
MCONTBLP-WHIT	White	USD 299.00	-

# DEDICATE LAMP SERIES

FOR MORE INFORMATION,  
EXPLORE BELOW

- ↗ [Product Fact Sheet](#)
- ↗ [Images](#)
- ↗ [Architect Files](#)
- ↗ [Assembly Instructions](#)
- ↗ [Product Declaration](#)
- ↗ [Lighting Files](#)

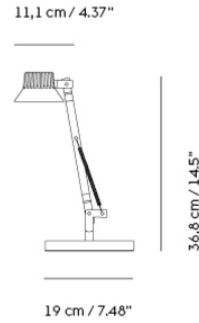

- Shipper Colli 2
- Gross Weight (kg) 5.26
- Net Weight (kg) 4.41
- Bulb included Dimmable, integrated, and non-user replaceable LED
- Warranty period 5 years

Pattern No.	Color	Contract Price	Lead Time
<b>Ready-To-Ship EU Warehouse</b>			
MDDCLS1TBLP-BLCK	Black	USD 786.00	-
MDDCLS1TBLP-BRGR	Brown Green	USD 786.00	-

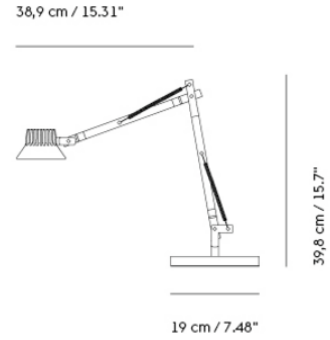

- Shipper Colli 2
- Gross Weight (kg) 5.59
- Net Weight (kg) 4.52
- Bulb included Dimmable, integrated, and non-user replaceable LED
- Warranty period 5 years

Pattern No.	Color	Contract Price	Lead Time
<b>Ready-To-Ship EU Warehouse</b>			
MDDCLS2TBLP/BLCK	Black	USD 835.00	-
MDDCLS2TBLP-BRGR	Brown Green	USD 835.00	-

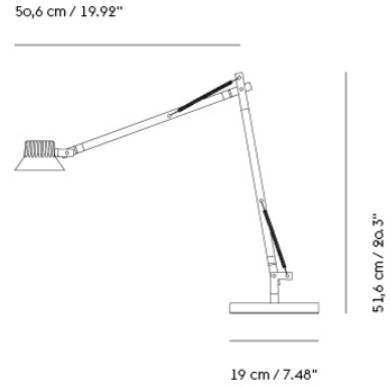

- Shipper Colli 2
- Gross Weight (kg) 5.74
- Net Weight (kg) 4.555
- Bulb included Dimmable, integrated, and non-user replaceable LED
- Warranty period 5 years

Pattern No.	Color	Contract Price	Lead Time
<b>Ready-To-Ship EU Warehouse</b>			
MDDCLL2TBLP-BLCK	Black	USD 835.00	-
MDDCLL2TBLP-BRGR	Brown Green	USD 835.00	-

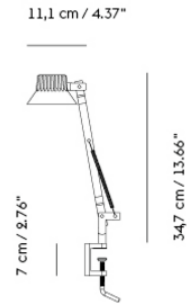

- Shipper Colli 2
- Gross Weight (kg) 0.885
- Net Weight (kg) 0.605
- Bulb included Dimmable, integrated, and non-user replaceable LED
- Warranty period 5 years

Pattern No.	Color	Contract Price	Lead Time
<b>Ready-To-Ship EU Warehouse</b>			
MDDCLS1WC-BLCK	Black	USD 629.00	-
MDDCLS1WC-BRGR	Brown Green	USD 629.00	-

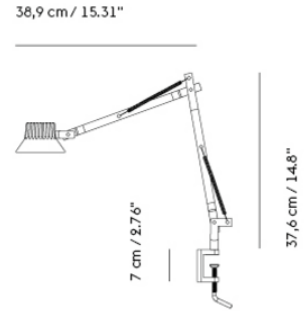
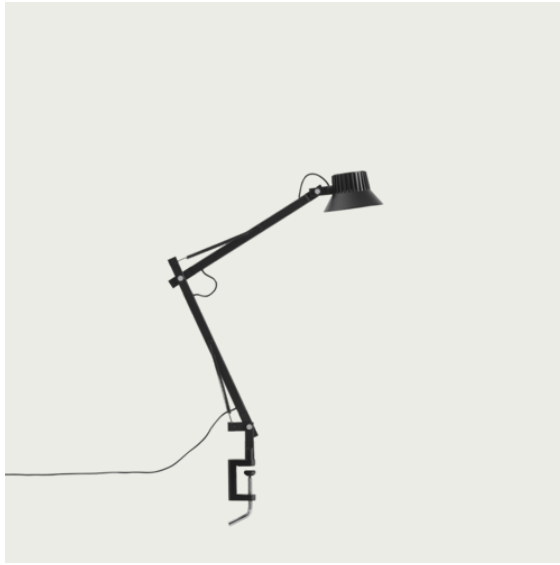

- Shipper Colli 2
- Gross Weight (kg) 1.215
- Net Weight (kg) 0.715
- Bulb included Dimmable, integrated, and non-user replaceable LED
- Warranty period 5 years

Pattern No.	Color	Contract Price	Lead Time
<b>Ready-To-Ship EU Warehouse</b>			
MDDCLS2WC-BLCK	Black	USD 677.00	-
MDDCLS2WC-BRGR	Brown Green	USD 677.00	-

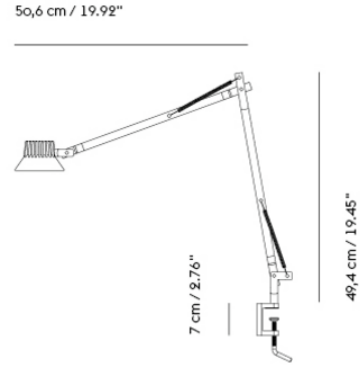

- Shipper Colli 2
- Gross Weight (kg) 1.365
- Net Weight (kg) 0.75
- Bulb included Dimmable, integrated, and non-user replaceable LED
- Warranty period 5 years

Pattern No.	Color	Contract Price	Lead Time
<b>Ready-To-Ship EU Warehouse</b>			
MDDCLL2WC-BLCK	Black	USD 677.00	-
MDDCLL2WC-BRGR	Brown Green	USD 677.00	-



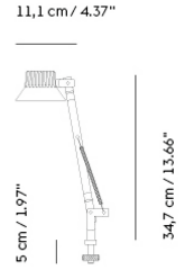

- Shipper Colli 2
- Gross Weight (kg) 0.76407
- Net Weight (kg) 0.58
- Bulb included Dimmable, integrated, and non-user replaceable LED
- Warranty period 5 years

Pattern No.	Color	Contract Price	Lead Time
<b>Ready-To-Ship EU Warehouse</b>			
MDDCLS1WP-BLCK	Black	USD 629.00	-
MDDCLS1WP-BRGR	Brown Green	USD 629.00	-

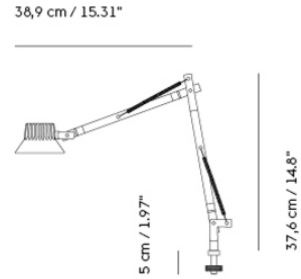

- Shipper Colli 2
- Gross Weight (kg) 1.235
- Net Weight (kg) 0.69
- Bulb included Dimmable, integrated, and non-user replaceable LED
- Warranty period 5 years

Pattern No.	Color	Contract Price	Lead Time
<b>Ready-To-Ship EU Warehouse</b>			
MDDCLS2WP-BLCK	Black	USD 677.00	-
MDDCLS2WP-BRGR	Brown Green	USD 677.00	-

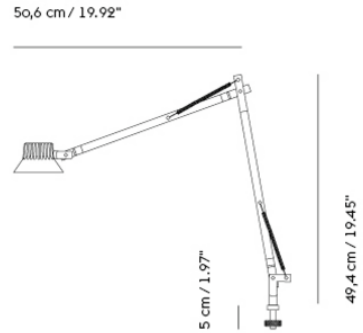

- Shipper Colli 2
- Gross Weight (kg) 1.385
- Net Weight (kg) 0.725
- Bulb included Dimmable, integrated, and non-user replaceable LED
- Warranty period 5 years

Pattern No.	Color	Contract Price	Lead Time
<b>Ready-To-Ship EU Warehouse</b>			
MDDCLL2WP-BLCK	Black	USD 677.00	-
MDDCLL2WP-BRGR	Brown Green	USD 677.00	-

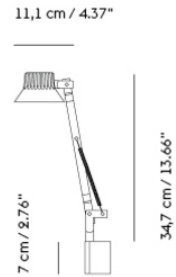
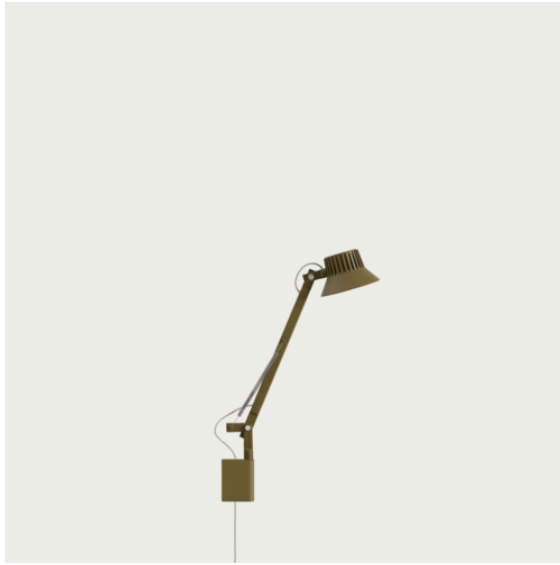

- Shipper Colli 2
- Gross Weight (kg) 0.84
- Net Weight (kg) 0.56
- Bulb included Dimmable, integrated, and non-user replaceable LED
- Warranty period 5 years

Pattern No.	Color	Contract Price	Lead Time
<b>Ready-To-Ship EU Warehouse</b>			
MDDCLS1WLLP-BLCK	Black	USD 629.00	-
MDDCLS1WLLP-BRGR	Brown Green	USD 629.00	-

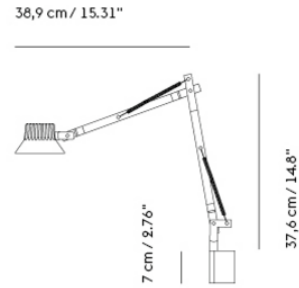
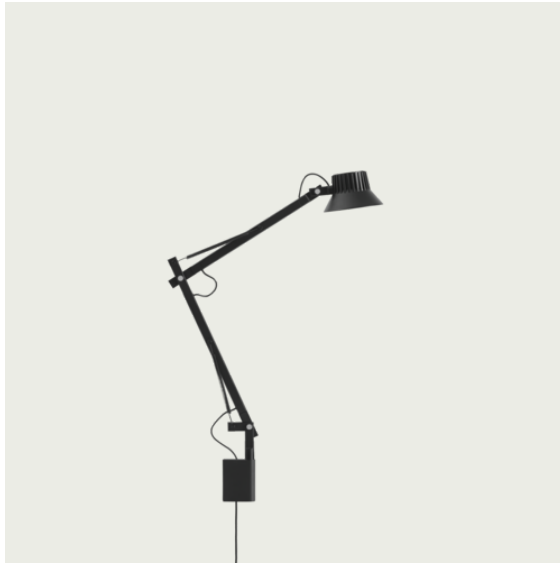

- Shipper Colli 2
- Gross Weight (kg) 1.17
- Net Weight (kg) 0.67
- Bulb included Dimmable, integrated, and non-user replaceable LED
- Warranty period 5 years

Pattern No.	Color	Contract Price	Lead Time
<b>Ready-To-Ship EU Warehouse</b>			
MDDCLS2WLLP-BLCK	Black	USD 677.00	-
MDDCLS2WLLP-BRGR	Brown Green	USD 677.00	-

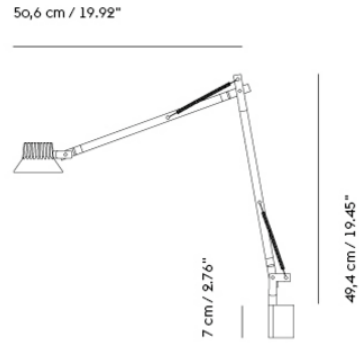

- Shipper Colli 2
- Gross Weight (kg) 1.32
- Net Weight (kg) 0.705
- Bulb included Dimmable, integrated, and non-user replaceable LED
- Warranty period 5 years

Pattern No.	Color	Contract Price	Lead Time
<b>Ready-To-Ship EU Warehouse</b>			
MDDCLL2WLLP-BLCK	Black	USD 677.00	-
MDDCLL2WLLP-BRGR	Brown Green	USD 677.00	-

# E27 PENDANT LAMP

FOR MORE INFORMATION,  
EXPLORE BELOW

- ↗ [Product Fact Sheet](#)
- ↗ [Images](#)
- ↗ [Architect Files](#)
- ↗ [Assembly Instructions](#)
- ↗ [Product Declaration](#)
- ↗ [Lighting Files](#)

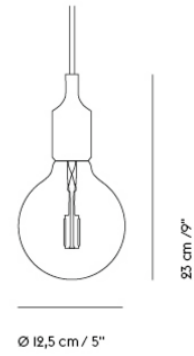

Shipper Colli	1
Gross Weight (kg)	0.7
Net Weight (kg)	0.3
Bulb included	Yes
Warranty Period	5 years

Pattern No.	Color	Contract Price	Lead Time
<b>Ready-To-Ship US Warehouse</b>			
ME27PDLP-DKGY	Dark Grey		-
ME27PDLP-BERO	Beige-Rose	USD 152.00	-
ME27PDLP-BLCK	Black	USD 152.00	-
ME27PDLP-CLBW	Clay Brown	USD 152.00	-
ME27PDLP-DKGN	Dark Green	USD 152.00	-
ME27PDLP-DPRD	Deep Red	USD 152.00	-
ME27PDLP-DLAC	Dusty Lilac	USD 152.00	-
ME27PDLP-LTBU	Light Blue	USD 152.00	-
ME27PDLP-LIGY	Light Grey	USD 152.00	-
ME27PDLP-LTOR	Light Orange	USD 152.00	-
ME27PDLP-MBLU	Midnight Blue	USD 152.00	-
ME27PDLP-MSTD	Mustard	USD 152.00	-
ME27PDLP-OLIV	Olive	USD 152.00	-
ME27PDLP-ORNG	Orange	USD 152.00	-
ME27PDLP-PABU	Pale Blue	USD 152.00	-
ME27PDLP-RED	Red	USD 152.00	-
ME27PDLP-ROSE	Rose	USD 152.00	-
ME27PDLP-TERR	Terracotta ***	USD 152.00	-
ME27PDLP-WHIT	White	USD 152.00	-
ME27PDLP-YELW	Yellow	USD 152.00	-



Pattern No.	Color	Contract Price	Lead Time
<b>Extras</b>			
MLPCRDE27P-BLCK	Unfold / E27 Cord - Black (per linear meter)	USD 4.00	-
MLPCRDE27P-OLIV	Unfold / E27 Cord - Olive (per linear meter)	USD 4.00	-
MLPCRDE27P-BEGN	E27 Cord - Beige-Green (per linear meter)	USD 5.00	-
MLPCRDE27P-BERO	E27 Cord - Beige-Rose (per linear meter)	USD 5.00	-
MLPCRDE27P-BLCK	E27 Cord - Black (per linear meter)	USD 5.00	-
MLPCRDE27P-BLUE	E27 Cord - Blue (per linear meter)	USD 5.00	-
MLPCRDE27P-BURG	E27 Cord - Burgundy (per linear meter)	USD 5.00	-
MLPCRDE27P-CLBW	E27 Cord - Clay Brown (per linear meter)	USD 5.00	-
MLPCRDE27P-LIGN	E27 Cord - Light Green (per linear meter)	USD 5.00	-
MLPCRDE27P-MSTD	E27 Cord - Mustard (per linear meter)	USD 5.00	-
MLPCRDE27P-PABU	E27 Cord - Pale Blue (per linear meter)	USD 5.00	-
MLPCRDE27P-RED	E27 Cord - Red (per linear meter)	USD 5.00	-
MLPCRDE27P-TERR	E27 Cord - Terracotta (per linear meter)	USD 5.00	-
MLPCRDE27P-YELW	E27 Cord - Yellow (per linear meter)	USD 5.00	-
MLPCRDUNFP-ORNG	Unfold / E27 Cord - Orange (per linear meter)	USD 5.00	-
MLPCAPL	Ceiling Cap - White	USD 28.00	-
MBULBLED	Dimmable Bulb for E27 Pendant Lamp	USD 42.00	-
ME27CPY	Multiple Canopy for E27 - White	USD 45.00	-

# FLUID PENDANT LAMP

FOR MORE INFORMATION,  
EXPLORE BELOW

- ↗ [Product Fact Sheet](#)
- ↗ [Images](#)
- ↗ [Architect Files](#)
- ↗ [Assembly Instructions](#)
- ↗ [Product Declaration](#)
- ↗ [Lighting Files](#)

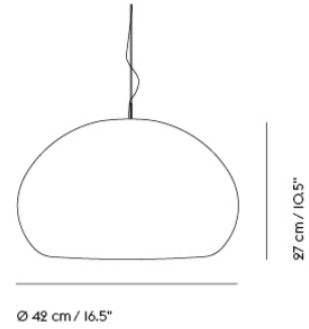

Shipper Colli	1
Gross Weight (kg)	4.95
Net Weight (kg)	3.1
Bulb included	No
Warranty Period	5 years

Pattern No.	Color	Contract Price	Lead Time
<b>Ready-To-Ship US Warehouse</b>			
MFLUPDLPLG	Opal White - Large	USD 667.00	-
<b>Extras</b>			
MBULBP	Dimmable Bulb for Fluid Small and Grain Pendant Lamp	USD 37.00	-
MLPCAPW	Ceiling Cap for wire suspension lamps - White	USD 58.00	-

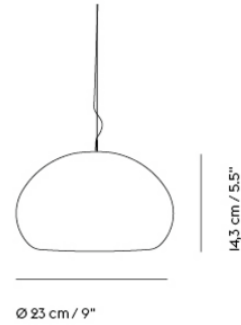
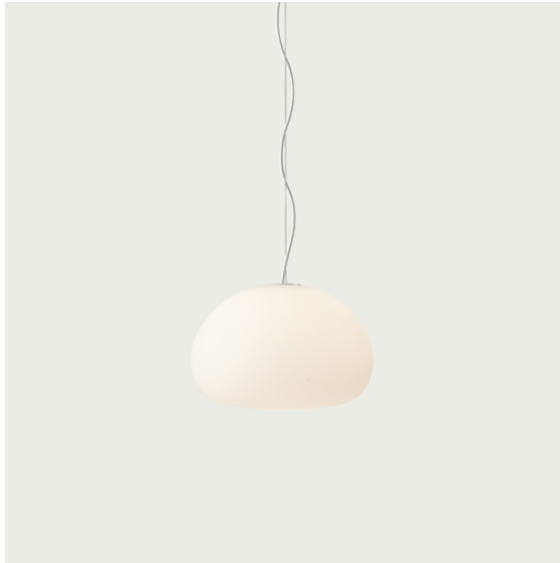

**Shipper Colli** 1  
**Gross Weight (kg)** 1.55  
**Net Weight (kg)** 0.85  
**Bulb included** Yes  
**Warranty Period** 5 years

Pattern No.	Color	Contract Price	Lead Time
<b>Ready-To-Ship US Warehouse</b>			
MFLUPDLPSM	Opal White - Small	USD 362.00	-
<b>Extras</b>			
MBULBP	Dimmable Bulb for Fluid Small and Grain Pendant Lamp	USD 37.00	-
MLPCAPW	Ceiling Cap for wire suspension lamps - White	USD 58.00	-

# GRAIN PENDANT LAMP

FOR MORE INFORMATION,  
EXPLORE BELOW

- ↗ [Product Fact Sheet](#)
- ↗ [Images](#)
- ↗ [Architect Files](#)
- ↗ [Assembly Instructions](#)
- ↗ [Lighting Files](#)

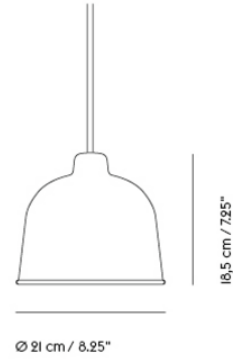

Shipper Colli	1
Gross Weight (kg)	1.17
Net Weight (kg)	0.76
Bulb included	Yes
Warranty Period	5 years

Pattern No.	Color	Contract Price	Lead Time
<b>Ready-To-Ship US Warehouse</b>			
MGRAPDLP-BLCK	Black	USD 303.00	-
MGRAPDLP-BUGY	Blue Grey	USD 303.00	-
MGRAPDLP-DKGN	Dark Green	USD 303.00	-
MGRAPDLP-DGRN	Dusty Green	USD 303.00	-
MGRAPDLP-GREY	Grey	USD 303.00	-
MGRAPDLP-NATU	Nature	USD 303.00	-
MGRAPDLP-WHIT	White	USD 303.00	-
<b>Extras</b>			
MLPCRDGRNP-BUGY	Grain Cord - Blue-Grey (per linear meter)	USD 5.00	-
MLPCRDGRNP-DKGN	Grain Cord - Dark Green (per linear meter)	USD 5.00	-
MLPCRDGRNP-DGRN	Grain Cord - Dusty Green (per linear meter)	USD 5.00	-
MLPCRDGRNP-GREY	Grain Cord - Grey (per linear meter)	USD 5.00	-
MLPCRDGRNP-NATU	Grain Cord - Nature (per linear meter)	USD 5.00	-
MLPCRDGRNP-BLCK	Rime Ø12+Ø25 / Grain Cord - Black (per linear meter)	USD 5.00	-
MLPCRDGRNP-WHIT	Rime Ø12+Ø25 / Grain Cord - White (per linear meter)	USD 5.00	-
MLPCAPL	Ceiling Cap - White	USD 28.00	-
MBULBP	Dimmable Bulb for Fluid Small and Grain Pendant Lamp	USD 37.00	-

# LEAF LAMP SERIES

FOR MORE INFORMATION,  
EXPLORE BELOW

- ↗ [Product Fact Sheet](#)
- ↗ [Images](#)
- ↗ [Architect Files](#)
- ↗ [Assembly Instructions](#)
- ↗ [Product Declaration](#)
- ↗ [Lighting Files](#)

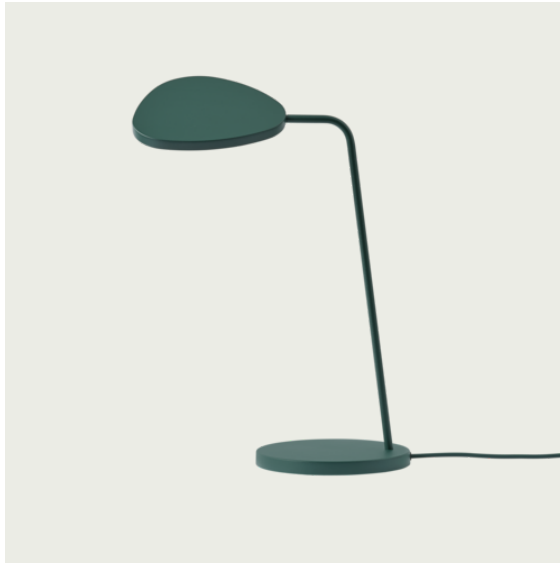

15,5 x 16,5 cm / 6" x 7.25"



41,5 cm / 16.35"

18 cm / 7"

Shipper Colli	1
Gross Weight (kg)	2.5
Net Weight (kg)	1.75
Bulb included	Yes. Integrated non-replaceable LED
Warranty Period	5 years

Pattern No.	Color	Contract Price	Lead Time
<b>Ready-To-Ship US Warehouse</b>			
MLEATBLP-BLCK	Black	USD 492.00	-
MLEATBLP-CPBN	Copper Brown	USD 492.00	-
MLEATBLP-DKGN	Dark Green	USD 492.00	-
MLEATBLP-GREY	Grey	USD 492.00	-
MLEATBLP-WHIT	White	USD 492.00	-



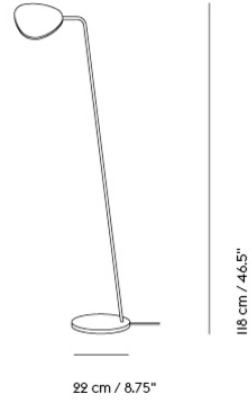
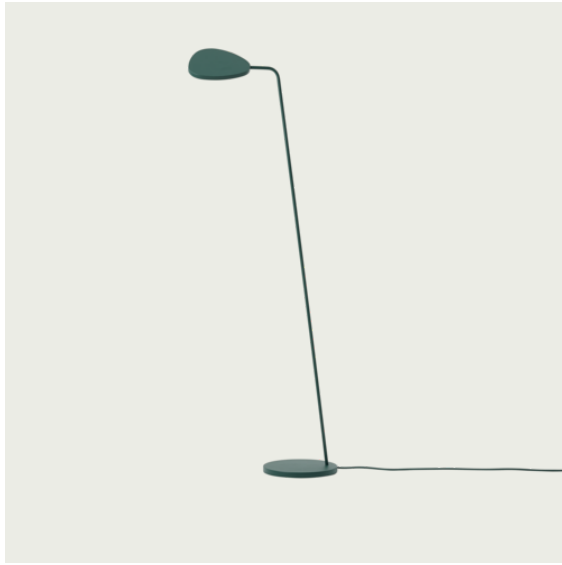

Shipper Colli	1
Gross Weight (kg)	5.2
Net Weight (kg)	2.8
Bulb included	Yes. Integrated non-replaceable LED
Warranty Period	5 years

Pattern No.	Color	Contract Price	Lead Time
<b>Ready-To-Ship US Warehouse</b>			
MLEAFLLP-BLCK	Black	USD 671.00	-
MLEAFLLP-CPBN	Copper Brown	USD 671.00	-
MLEAFLLP-DKGN	Dark Green	USD 671.00	-
MLEAFLLP-GREY	Grey	USD 671.00	-
MLEAFLLP-WHIT	White	USD 671.00	-

# LINEAR LAMP SERIES

FOR MORE INFORMATION,  
EXPLORE BELOW

- ↗ [Product Fact Sheet](#)
- ↗ [Images](#)
- ↗ [Architect Files](#)
- ↗ [Assembly Instructions](#)
- ↗ [Product Declaration](#)
- ↗ [Lighting Files](#)



- Shipper Colli** | 1
- Gross Weight (kg)** | 1.832
- Net Weight (kg)** | 1.3
- Bulb included** | Yes. Integrated, dimmable, non-replaceable LED module.
- Add-ons** | Please visit [planner.muuto.com/linear](http://planner.muuto.com/linear) for recommended lighting, power and accessories
- Warranty Period** | 5 years

Pattern No.	Color	Contract Price	Lead Time
<b>Ready-To-Ship US Warehouse</b>			
MLINLTBLP-BLCK	Black	USD 492.00	-
MLINLTBLP-GREY	Grey	USD 492.00	-



W 169,2 cm / 66.6"  
D 10,7 cm / 4.2"

Shipper Colli	1
Gross Weight (kg)	4.9
Net Weight (kg)	3.3
Bulb included	Yes. Integrated LED.
Warranty Period	5 years

Pattern No.	Color	Contract Price	Lead Time
<b>Ready-To-Ship US Warehouse</b>			
MLINLPDLP66-BLCK	Black	USD 1,465.00	-
MLINLPDLP66-GREY	Grey	USD 1,465.00	-

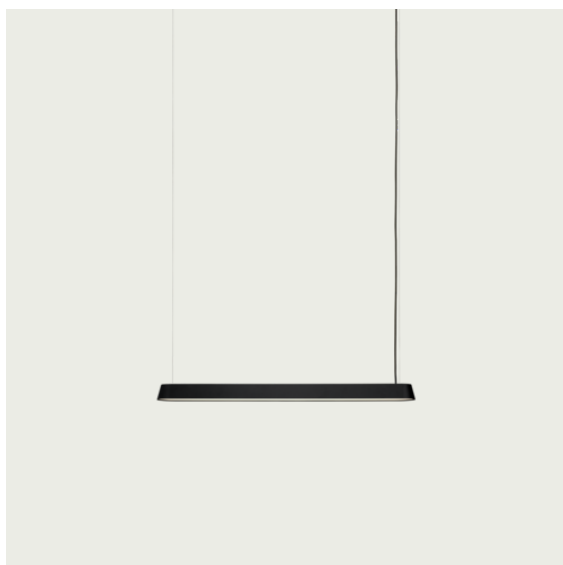

W 87,2 cm / 34,3"  
D 10,7 cm / 4,2"

Shipper Colli	1
Gross Weight (kg)	3.2
Net Weight (kg)	2.2
Bulb included	Yes. Integrated LED.
Warranty Period	5 years

Pattern No.	Color	Contract Price	Lead Time
<b>Ready-To-Ship US Warehouse</b>			
MLINLPDLP34-BLCK	Black	USD 1,101.00	-
MLINLPDLP34-GREY	Grey	USD 1,101.00	-

# LINEAR MOUNTED LAMP / 209,2 CM / 82.4"

539

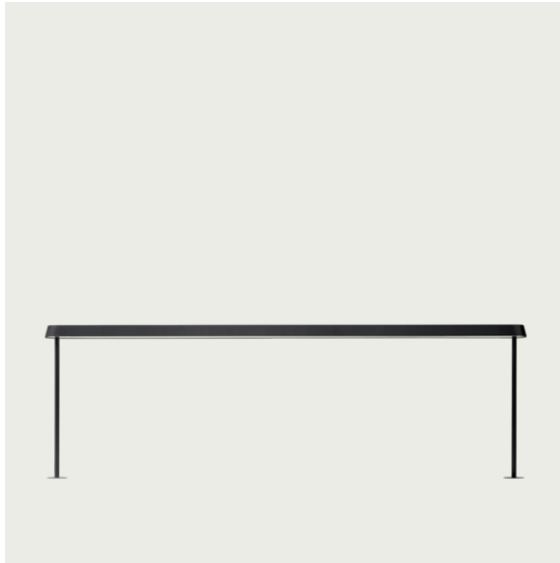

<b>Shipper Colli</b>	1
<b>Gross Weight (kg)</b>	7.8
<b>Net Weight (kg)</b>	4.8
<b>Please note</b>	Only usable with Linear System Power Kit. The connector pins in this product contains lead, CAS no. 7439-92-1.
<b>Bulb included</b>	Yes. Integrated LED.
<b>Warranty Period</b>	5 years

Pattern No.	Color	Contract Price	Lead Time
<b>Ready-To-Ship US Warehouse</b>			
MLINSYML82-BLCK	Black	USD 2,046.00	-
MLINSYML82-GREY	Grey	USD 2,046.00	-

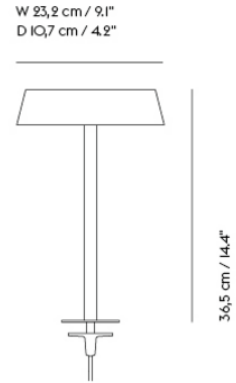

- Shipper Colli 1
- Gross Weight (kg) 1.5
- Net Weight (kg) 1
- Please note 1. Only usable with Linear System Power Kit. The connector pins in this product contains lead, CAS no. 7439-92-
- Bulb included Yes. Integrated LED.
- Warranty Period 5 years

Pattern No.	Color	Contract Price	Lead Time
<b>Ready-To-Ship US Warehouse</b>			
MLINSYML9-BLCK	Black	USD 614.00	-
MLINSYML9-GREY	Grey	USD 614.00	-

# POST LAMP SERIES

FOR MORE INFORMATION,  
EXPLORE BELOW

- ↗ [Product Fact Sheet](#)
- ↗ [Images](#)
- ↗ [Architect Files](#)
- ↗ [Assembly Instructions](#)
- ↗ [Product Declaration](#)
- ↗ [Lighting Files](#)



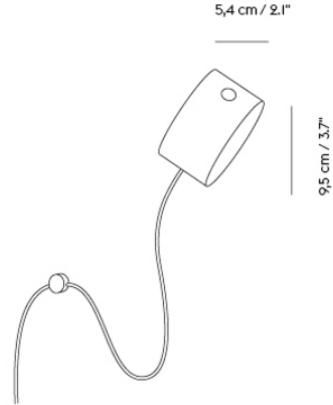

**Shipper Colli** |  
**Gross Weight (kg)** 1.05  
**Net Weight (kg)** 0.55  
**Bulb included** Yes. Integrated non-replaceable LED  
**Warranty Period** 5 years

Pattern No.	Color	Contract Price	Lead Time
<b>Ready-To-Ship US Warehouse</b>			
MPOSWLLP	Black	USD 492.00	-
<b>Extras</b>			
MPOSWMNT	Extra Wall Mount - Black	USD 41.00	-

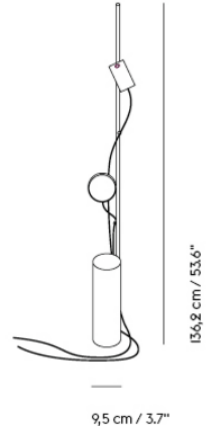

- Shipper Colli 1
- Gross Weight (kg) 12.5
- Net Weight (kg) 10.2
- Bulb included Yes. Integrated non-replaceable LED
- Warranty Period 5 years

Pattern No.	Color	Contract Price	Lead Time
<b>Ready-To-Ship US Warehouse</b>			
MPOSFLP	Black	USD 1,206.00	-
<b>Extras</b>			
MPLCD	Extra Cable Drops - Black	USD 49.00	-

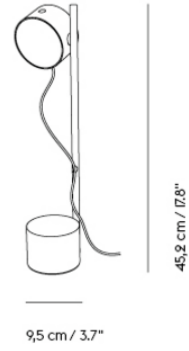

- Shipper Colli 1
- Gross Weight (kg) 3.9
- Net Weight (kg) 2.9
- Bulb included Yes. Integrated non-replaceable LED
- Warranty Period 5 years

Pattern No.	Color	Contract Price	Lead Time
<b>Ready-To-Ship US Warehouse</b>			
MPOSTBLP-BLCK	Black	USD 828.00	-
MPOSTBLP-BRGR	Brown Green	USD 828.00	-

# PULL FLOOR LAMP

FOR MORE INFORMATION,  
EXPLORE BELOW

- ↗ [Product Fact Sheet](#)
- ↗ [Images](#)
- ↗ [Architect Files](#)
- ↗ [Assembly Instructions](#)

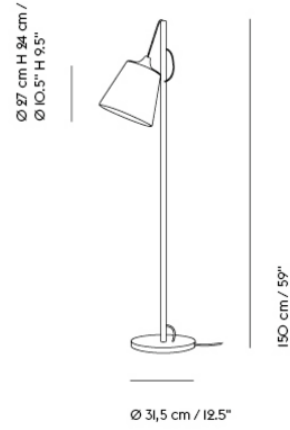

**Shipper Colli** 1  
**Gross Weight (kg)** 6.75  
**Net Weight (kg)** 3.75  
**Bulb included** No  
**Warranty Period** 5 years

Pattern No.	Color	Contract Price	Lead Time
<b>Ready-To-Ship US Warehouse</b>			
MPULFLLP-GREYW	Grey/White	USD 786.00	-
MPULFLLP-OAKW	Oak/White	USD 786.00	-

# RIME LAMP SERIES

FOR MORE INFORMATION,  
EXPLORE BELOW

- ↗ [Product Fact Sheet](#)
- ↗ [Images](#)
- ↗ [Architect Files](#)
- ↗ [Assembly Instructions](#)
- ↗ [Product Declaration](#)
- ↗ [Lighting Files](#)

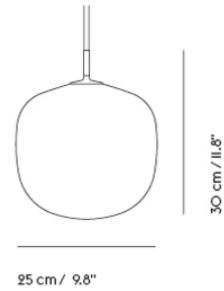

Shipper Colli	1
Gross Weight (kg)	3.4
Net Weight (kg)	1.5
Bulb included	No
Warranty Period	5 years

Pattern No.	Color	Contract Price	Lead Time
<b>Ready-To-Ship US Warehouse</b>			
MRIMPDLP09-BLCK	Black	USD 509.00	-
MRIMPDLP09-WHIT	White	USD 509.00	-
<b>Extras</b>			
MLPCRDGRNP-BLCK	Rime Ø12+Ø25 / Grain Cord - Black (per linear meter)	USD 5.00	-
MLPCRDGRNP-WHIT	Rime Ø12+Ø25 / Grain Cord - White (per linear meter)	USD 5.00	-
MLPCAPL	Ceiling Cap - White	USD 28.00	-

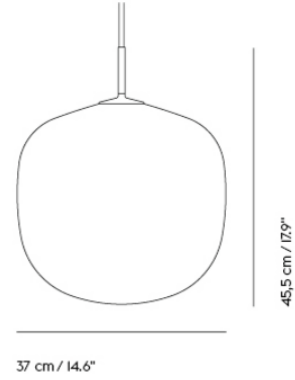

Shipper Colli	1
Gross Weight (kg)	5.25
Net Weight (kg)	3.3
Bulb included	No
Warranty Period	5 years

Pattern No.	Color	Contract Price	Lead Time
<b>Ready-To-Ship US Warehouse</b>			
MRIMPDLP14-BLCK	Black	USD 667.00	-
MRIMPDLP14-WHIT	White	USD 667.00	-
<b>Extras</b>			
MLPCRDRIMP-BLCK	Rime Cord Ø37 + Ø45 cm - Black (per linear meter)	USD 10.00	-
MLPCRDRIMP-WHIT	Rime Cord Ø37 + Ø45 cm - White (per linear meter)	USD 10.00	-
MLPCAPL	Ceiling Cap - White	USD 28.00	-



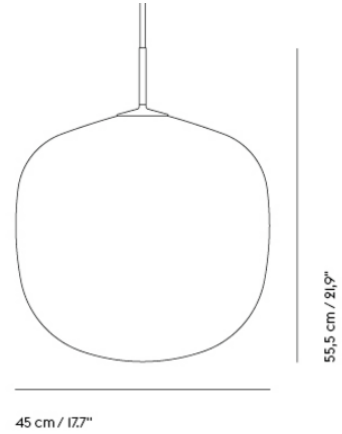

Shipper Colli	1
Gross Weight (kg)	8.5
Net Weight (kg)	4
Bulb included	No
Warranty Period	5 years

Pattern No.	Color	Contract Price	Lead Time
<b>Ready-To-Ship US Warehouse</b>			
MRIMPDLP17-BLCK	Black	USD 902.00	-
MRIMPDLP17-WHIT	White	USD 902.00	-
<b>Extras</b>			
MLPCRDRIMP-BLCK	Rime Cord Ø37 + Ø45 cm - Black (per linear meter)	USD 10.00	-
MLPCRDRIMP-WHIT	Rime Cord Ø37 + Ø45 cm - White (per linear meter)	USD 10.00	-
MLPCAPL	Ceiling Cap - White	USD 28.00	-

# SET TABLE LAMP

FOR MORE INFORMATION,  
EXPLORE BELOW

- ↗ [Product Fact Sheet](#)
- ↗ [Images](#)
- ↗ [Architect Files](#)
- ↗ [Assembly Instructions](#)
- ↗ [Product Declaration](#)
- ↗ [Lighting Files](#)

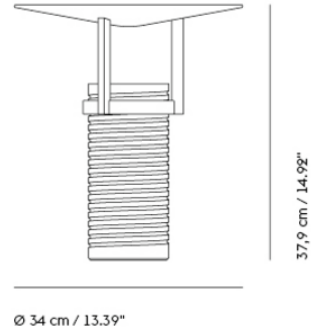

- Shipper Colli | 1
- Gross Weight (kg) | 9.34
- Net Weight (kg) | 6.11
- Bulb included | Dimmable, integrated, and non-user replaceable LED
- Warranty Period | 5 years

Pattern No.	Color	Contract Price	Lead Time
<b>Ready-To-Ship US Warehouse</b>			
MSETTBLP	Aluminum	USD 1,150.00	-

# STRAND LAMP SERIES

FOR MORE INFORMATION,  
EXPLORE BELOW

- ↗ [Product Fact Sheet](#)
- ↗ [Images](#)
- ↗ [Architect Files](#)
- ↗ [Assembly Instructions](#)
- ↗ [Product Declaration](#)
- ↗ [Lighting Files](#)

**STRAND PENDANT LAMP / OPEN - Ø 28 CM / 11"**

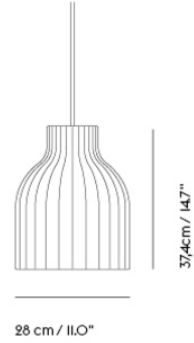

**Shipper Colli** 1  
**Gross Weight (kg)** 2.35  
**Net Weight (kg)** 1.4  
**Bulb included** No  
**Warranty Period** 5 years

Pattern No.	Color	Contract Price	Lead Time
<b>Ready-To-Ship US Warehouse</b>			
MSTRPDLPO11	White - Open	USD 534.00	-

# STRAND PENDANT LAMP / OPEN - Ø 40 CM / 16"

555

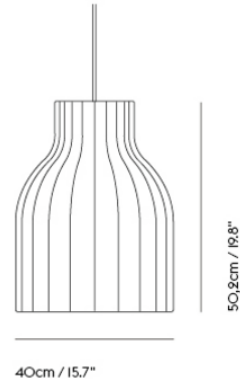

**Shipper Colli** 1  
**Gross Weight (kg)** 3.7  
**Net Weight (kg)** 2.1  
**Bulb included** No  
**Warranty Period** 5 years

Pattern No.	Color	Contract Price	Lead Time
<b>Ready-To-Ship US Warehouse</b>			
MSTRPDLPO16	White - Open	USD 719.00	-

**STRAND PENDANT LAMP / OPEN - Ø 60  
CM / 23.5"**

556

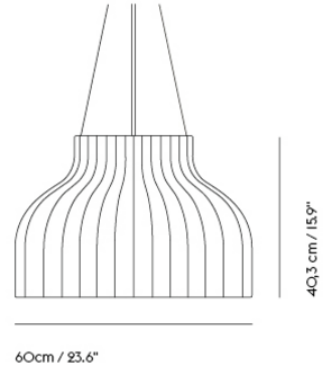

**Shipper Colli** 1  
**Gross Weight (kg)** 6.6  
**Net Weight (kg)** 4.05  
**Bulb included** No  
**Warranty Period** 5 years

Pattern No.	Color	Contract Price	Lead Time
<b>Ready-To-Ship US Warehouse</b>			
MSTRPDLPO23	White - Open	USD 992.00	-

# STRAND PENDANT LAMP / CLOSED - Ø 45 CM / 17.7"

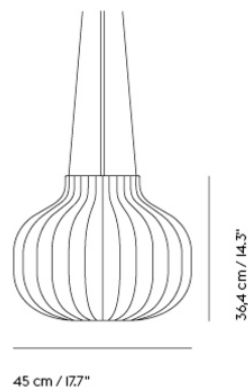
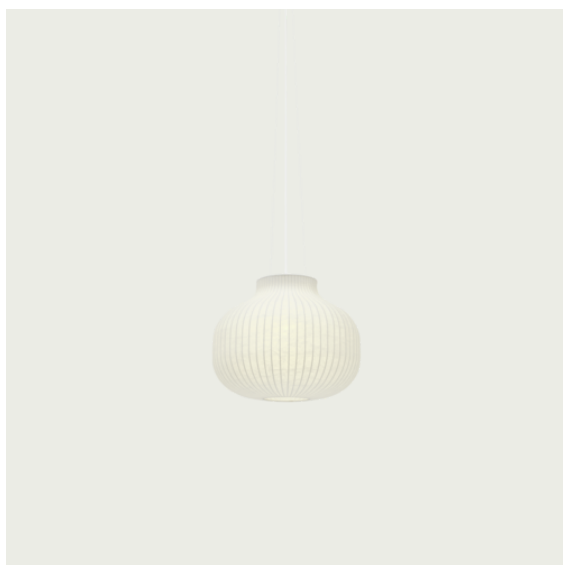

Gross Weight (kg)	4.45
Net Weight (kg)	2.75
Bulb included	No
Warranty Period	5 years

Pattern No.	Color	Contract Price	Lead Time
<b>Ready-To-Ship US Warehouse</b>			
MSTRPDLPC17	White - Closed - Ø 17.7"	USD 1,013.00	-



**STRAND PENDANT LAMP / CLOSED - Ø  
60 CM / 23.5"**

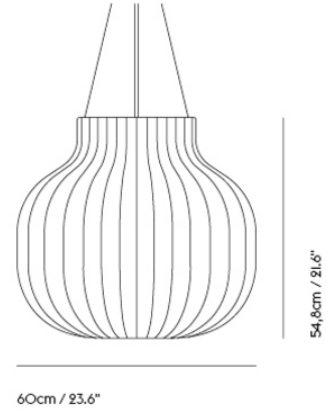

- Shipper Colli 1
- Gross Weight (kg) 8.4
- Net Weight (kg) 5.4
- Bulb included No
- Warranty Period 5 years

Pattern No.	Color	Contract Price	Lead Time
<b>Ready-To-Ship US Warehouse</b>			
MSTRPDLPC23	White - Closed	USD 1,101.00	-

**STRAND PENDANT LAMP / CLOSED - Ø  
80 CM / 31.5"**

559

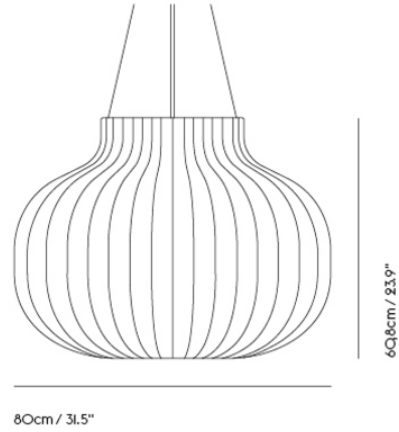

**Shipper Colli** 1  
**Gross Weight (kg)** 11.05  
**Net Weight (kg)** 6.35  
**Bulb included** No  
**Warranty Period** 5 years

Pattern No.	Color	Contract Price	Lead Time
<b>Ready-To-Ship US Warehouse</b>			
MSTRPDLPC31	White - Closed	USD 1,360.00	-

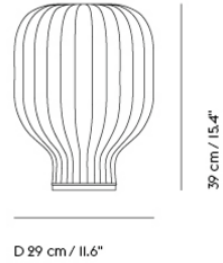

**Shipper Colli** 1  
**Gross Weight (kg)** 5  
**Net Weight (kg)** 2.9  
**Bulb included** No  
**Warranty Period** 5 years

Pattern No.	Color	Contract Price	Lead Time
<b>Ready-To-Ship US Warehouse</b>			
MSTRTBLP15	White	USD 797.00	-

# TIP LAMP SERIES

FOR MORE INFORMATION,  
EXPLORE BELOW

- ↗ [Product Fact Sheet](#)
- ↗ [Images](#)
- ↗ [Architect Files](#)
- ↗ [Assembly Instructions](#)
- ↗ [Product Declaration](#)
- ↗ [Lighting Files](#)



Shipper Colli	1
Gross Weight (kg)	2.4
Net Weight (kg)	1.5
Bulb included	Yes. Integrated non-replaceable LED
Warranty Period	5 years

Pattern No.	Color	Contract Price	Lead Time
<b>Ready-To-Ship US Warehouse</b>			
MTIPTBLP-BLCK	Black	USD 492.00	-
MTIPTBLP-CPBN	Copper Brown	USD 492.00	-
MTIPTBLP-OLIV	Olive	USD 492.00	-
MTIPTBLP-WHIT	White	USD 492.00	-

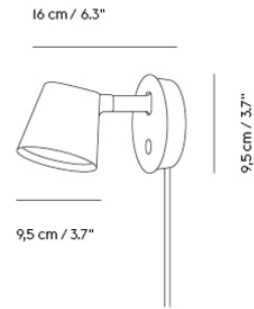

**Shipper Colli** | 1  
**Gross Weight (kg)** | 0.75  
**Net Weight (kg)** | 0.45  
**Bulb included** | Yes. Integrated non-replaceable LED  
**Warranty Period** | 5 years

Pattern No.	Color	Contract Price	Lead Time
<b>Ready-To-Ship US Warehouse</b>			
MTIPWLLP-BLCK	Black	USD 331.00	-
MTIPWLLP-GREY	Grey	USD 331.00	-
MTIPWLLP-WHIT	White	USD 331.00	-

# UNDER THE BELL PENDANT LAMP

FOR MORE INFORMATION,  
EXPLORE BELOW

- ↗ [Product Fact Sheet](#)
- ↗ [Images](#)
- ↗ [Architect Files](#)
- ↗ [Assembly Instructions](#)
- ↗ [Lighting Files](#)

# UNDER THE BELL PENDANT LAMP / Ø 55 CM / 21.7"

565

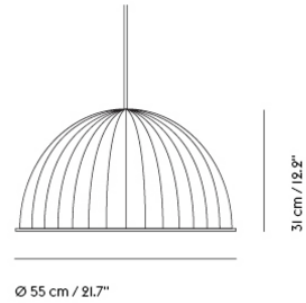

Shipper Colli	1
Gross Weight (kg)	2.35
Net Weight (kg)	1.15
Bulb included	No
Warranty Period	5 years

Pattern No.	Color	Contract Price	Lead Time
-------------	-------	----------------	-----------

## Ready-To-Ship US Warehouse

MUTBPDLPSP-BLCK	Black	USD 761.00	-
MUTBPDLPSP-DKGN	Dark Green	USD 761.00	-
MUTBPDLPSP-GREY	Grey	USD 761.00	-
MUTBPDLPSP-WHME	White Mélange	USD 761.00	-

## Extras

MLPCRDUTBP-BLCK	Under the Bell Cord - Black (per linear meter)	USD 4.00	-
MLPCRDUTBP-DKGN	Under the Bell Cord - Dark Green (per linear meter)	USD 4.00	-
MLPCRDUTBP-GREY	Under the Bell Cord - Grey (per linear meter)	USD 4.00	-
MLPCRDUTBP-WHME	Under the Bell Cord - White Mélange (per linear meter)	USD 4.00	-
MLPCAPL	Ceiling Cap - White	USD 28.00	-



# UNDER THE BELL PENDANT LAMP / Ø 82 CM / 32.25"

566

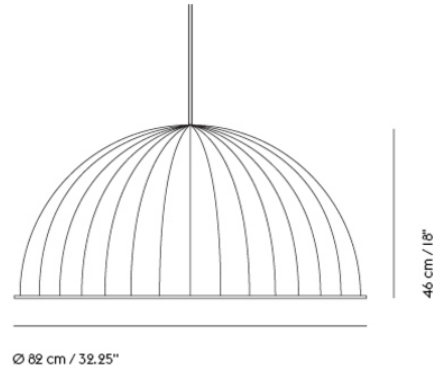

Shipper Colli	1
Gross Weight (kg)	4.95
Net Weight (kg)	2.35
Bulb included	No
Warranty Period	5 years

Pattern No.	Color	Contract Price	Lead Time
<b>Ready-To-Ship US Warehouse</b>			
MUTBPDPLG-BLCK	Black	USD 933.00	-
MUTBPDPLG-DKGN	Dark Green	USD 933.00	-
MUTBPDPLG-GREY	Grey	USD 933.00	-
MUTBPDPLG-WHME	White Mélange	USD 933.00	-
<b>Extras</b>			
MLPCRDUTBP-BLCK	Under the Bell Cord - Black (per linear meter)	USD 4.00	-
MLPCRDUTBP-DKGN	Under the Bell Cord - Dark Green (per linear meter)	USD 4.00	-
MLPCRDUTBP-GREY	Under the Bell Cord - Grey (per linear meter)	USD 4.00	-
MLPCRDUTBP-WHME	Under the Bell Cord - White Mélange (per linear meter)	USD 4.00	-
MLPCAPL	Ceiling Cap - White	USD 28.00	-

# UNFOLD PENDANT LAMP

FOR MORE INFORMATION,  
EXPLORE BELOW

- ↗ [Product Fact Sheet](#)
- ↗ [Images](#)
- ↗ [Architect Files](#)
- ↗ [Assembly Instructions](#)
- ↗ [Product Declaration](#)
- ↗ [Lighting Files](#)

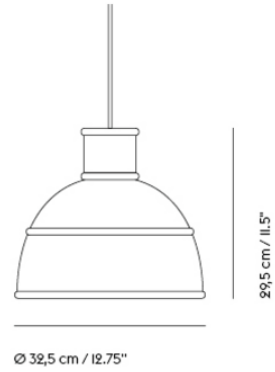

Shipper Colli	1
Gross Weight (kg)	1.8
Net Weight (kg)	1.26
Bulb included	No
Warranty Period	5 years

Pattern No.	Color	Contract Price	Lead Time
-------------	-------	----------------	-----------

**Ready-To-Ship US Warehouse**

MUNFPDLP-BEGN	Beige-Green	USD 362.00	-
MUNFPDLP-BERO	Beige-Rose	USD 362.00	-
MUNFPDLP-BLCK	Black	USD 362.00	-
MUNFPDLP-BURG	Burgundy	USD 362.00	-
MUNFPDLP-DKGY	Dark Grey	USD 362.00	-
MUNFPDLP-GREN	Green	USD 362.00	-
MUNFPDLP-LIGY	Light Grey	USD 362.00	-
MUNFPDLP-MSTD	Mustard	USD 362.00	-
MUNFPDLP-OLIV	Olive	USD 362.00	-
MUNFPDLP-TERR	Terracotta	USD 362.00	-
MUNFPDLP-WHIT	White	USD 362.00	-
MUNFPDLP-YELW	Yellow	USD 362.00	-

**Extras**

MLPCRDUUNFP-BERO	Unfold / E27 Cord - Beige-Rose (per linear meter)	USD 4.00	-
MLPCRDE27P-BLCK	Unfold / E27 Cord - Black (per linear meter)	USD 4.00	-
MLPCRDE27P-OLIV	Unfold / E27 Cord - Olive (per linear meter)	USD 4.00	-
MLPCRDE27P-TERR	Unfold Cord - Terracotta (per linear meter)	USD 4.00	-
MLPCRDUUNFP-ORNG	Unfold / E27 Cord - Orange (per linear meter)	USD 5.00	-
MLPCRDUUNFP-BEGN	Unfold Cord - Beige-Green (per linear meter)	USD 5.00	-
MLPCRDUUNFP-BURG	Unfold Cord - Burgundy (per linear meter)	USD 5.00	-

Pattern No.	Color	Contract Price	Lead Time
MLPCRDUNFP-CLBW	Unfold Cord - Clay Brown (per linear meter)	USD 5.00	-
MLPCRDUNFP-DKGY	Unfold Cord - Dark Grey (per linear meter)	USD 5.00	-
MLPCRDUNFP-DRED	Unfold Cord - Dusty Red (per linear meter)	USD 5.00	-
MLPCRDUNFP-GREN	Unfold Cord - Green (per linear meter)	USD 5.00	-
MLPCRDUNFP-YELW	Unfold Cord - Yellow (per linear meter)	USD 5.00	-
MLPCAPL	Ceiling Cap - White	USD 28.00	-

# ACCESSORIES

# AMPLE THROW

FOR MORE INFORMATION,  
EXPLORE BELOW

[↗ Product Fact Sheet](#)

[↗ Images](#)

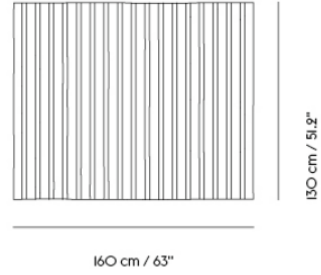

**Shipper Colli** 1  
**Gross Weight (kg)** 1.6  
**Net Weight (kg)** 1.5  
**Warranty Period** 5 years

Pattern No.	Color	Contract Price	Lead Time
<b>Ready-To-Ship US Warehouse</b>			
MAMPTH-DKGY	Dark Grey	USD 541.00	-
MAMPTH-MBLU	Midnight Blue	USD 541.00	-

# ARCED MIRROR

FOR MORE INFORMATION,  
EXPLORE BELOW

- ↗ [Product Fact Sheet](#)
- ↗ [Images](#)
- ↗ [Architect Files](#)
- ↗ [Assembly Instructions](#)
- ↗ [Product Declaration](#)



**ARCED MIRROR / 80 X 55 CM / 31.5 X 21.65"**

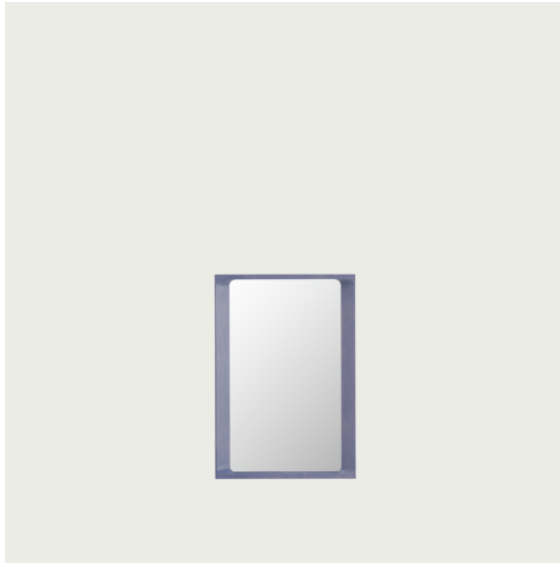

Shipper Colli I  
 Gross Weight (kg) 11  
 Net Weight (kg) 8.5  
 Warranty period 5 years

Pattern No.	Color	Contract Price	Lead Time
<b>Ready-To-Ship US Warehouse</b>			
MARCMIR3222-LGREY	Light Grey	USD 719.00	-
MARCMIR3222-LGRN	Light Green	USD 929.00	-
MARCMIR3222-LLIL	Light Lilac	USD 929.00	-

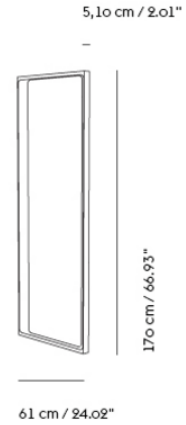
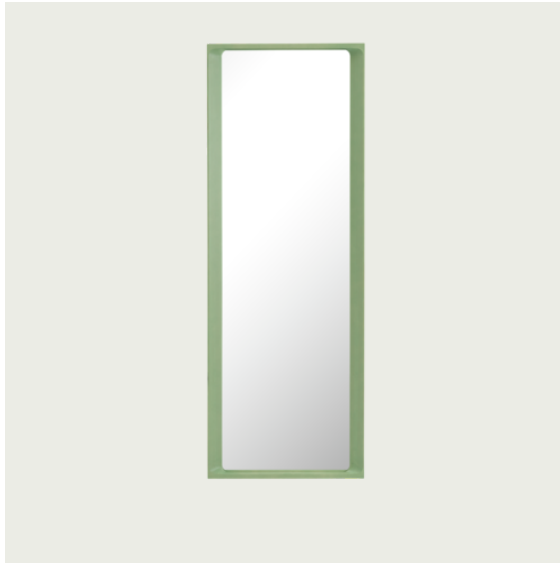

Shipper Colli 1  
 Gross Weight (kg) 24  
 Net Weight (kg) 19.5  
 Warranty period 5 years

Pattern No.	Color	Contract Price	Lead Time
<b>Ready-To-Ship US Warehouse</b>			
MARCMIR6724-LGREY	Light Grey	USD 1,255.00	-
MARCMIR6724-LGRN	Light Green	USD 1,731.00	-
MARCMIR6724-LLIL	Light Lilac	USD 1,731.00	-

# ARRANGE DESKTOP SERIES

FOR MORE INFORMATION,  
EXPLORE BELOW

- ↗ [Product Fact Sheet](#)
- ↗ [Images](#)
- ↗ [Architect Files](#)
- ↗ [Assembly Instructions](#)
- ↗ [Product Declaration](#)

# ARRANGE DESKTOP SERIES / CONFIGURATION I

577

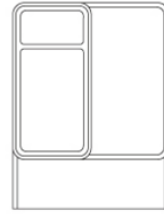
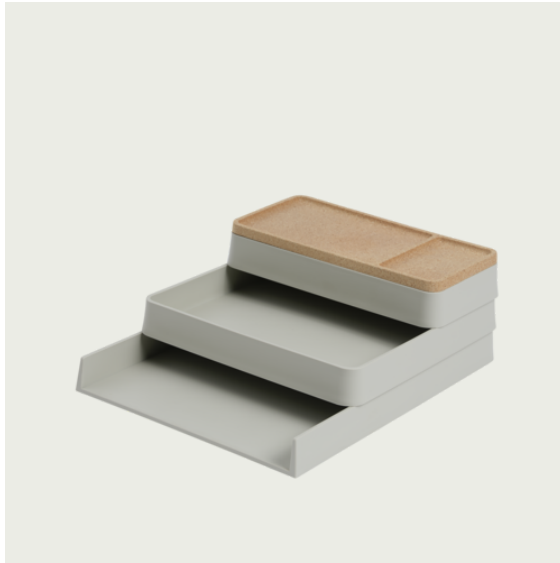

25 cm / 9.8"

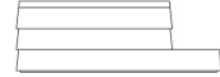

32 cm / 12.6"

11 cm / 4.3"

Shipper Colli	1
Gross Weight (kg)	1.696
Net Weight (kg)	0.934
Warranty Period	5 years

Pattern No.	Color	Contract Price	Lead Time
<b>Ready-To-Ship US Warehouse</b>			
MARRDSC1	Grey	USD 131.00	-

# ARRANGE DESKTOP SERIES / CONFIGURATION 2

578

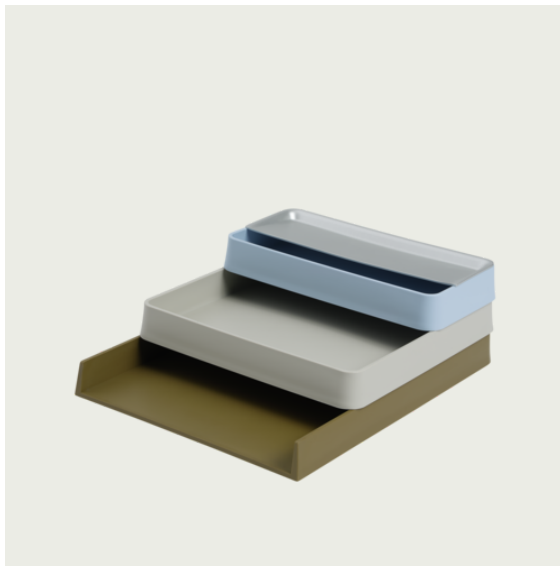

25 cm / 9.6"



32 cm / 12.6"

10 cm / 3.9"

Shipper Colli 1  
Gross Weight (kg) 1.728  
Net Weight (kg) 0.968  
Warranty Period 5 years

Pattern No.	Color	Contract Price	Lead Time
<b>Ready-To-Ship US Warehouse</b>			
MARRDSC2	Multi Colored	USD 131.00	-

# ARRANGE DESKTOP SERIES / TRAY - 12 X 25 CM / 4.8 X 9.6"

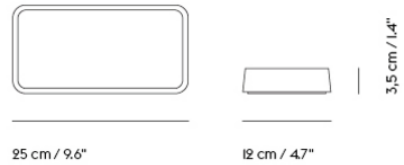

**Shipper Colli** | 1  
**Gross Weight (kg)** | 0.259  
**Net Weight (kg)** | 0.196  
**Warranty Period** | 5 years

Pattern No.	Color	Contract Price	Lead Time
<b>Ready-To-Ship US Warehouse</b>			
MARRDSTR510-GREY	Grey	USD 29.00	-
MARRDSTR510-LTBU	Light Blue	USD 29.00	-

# ARRANGE DESKTOP SERIES / TRAY - 25 X 25 CM / 9.6 X 9.6"

580

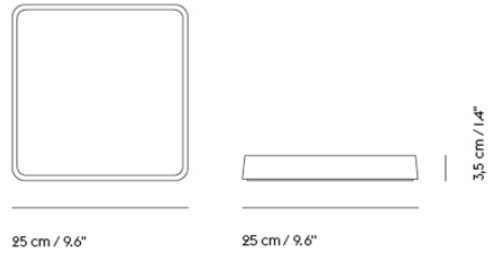
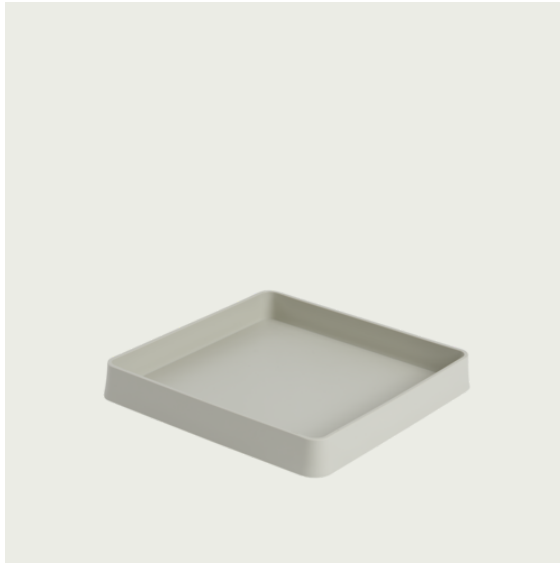

**Shipper Colli** |  
**Gross Weight (kg)** 0.44  
**Net Weight (kg)** 0.3325  
**Warranty Period** 5 years

Pattern No.	Color	Contract Price	Lead Time
<b>Ready-To-Ship US Warehouse</b>			
MARRDSTR1010-GREY	Grey	USD 36.00	-

**ARRANGE DESKTOP SERIES / TRAY - 32 X 25 CM / 12.6 X 9.6"**

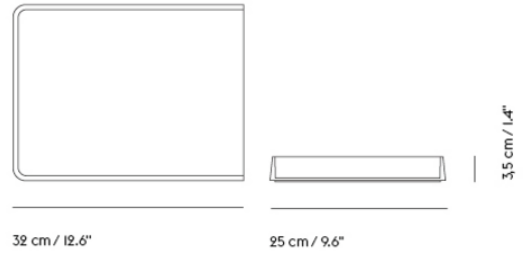
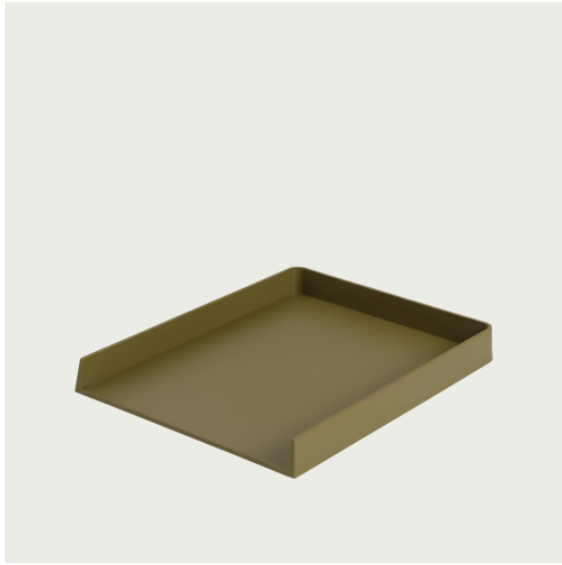

**Shipper Colli** 1  
**Gross Weight (kg)** 0.599  
**Net Weight (kg)** 0.471  
**Warranty Period** 5 years

Pattern No.	Color	Contract Price	Lead Time
<b>Ready-To-Ship US Warehouse</b>			
MARRDSTR1010-BRGR	Brown Green	USD 46.00	-
MARRDSTR1310-GREY	Grey	USD 46.00	-



# ATTACHED COAT HOOK

FOR MORE INFORMATION,  
EXPLORE BELOW

- ↗ [Product Fact Sheet](#)
- ↗ [Images](#)
- ↗ [Architect Files](#)

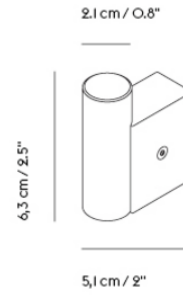

**Shipper Colli** 1  
**Gross Weight (kg)** 0.24  
**Net Weight (kg)** 0.2  
**Warranty Period** 5 years

Pattern No.	Color	Contract Price	Lead Time
<b>Ready-To-Ship US Warehouse</b>			
MATTCH-ALUM	Oak/Aluminum	USD 89.00	-
MATTCH-BLCK	Oak/Black	USD 89.00	-
MATTCH-BORG	Oak/Burnt Orange	USD 89.00	-
MATTCH-DKGN	Oak/Dark Green	USD 89.00	-
MATTCH-PABU	Oak/Pale Blue	USD 89.00	-

# AVAIL COAT RACK

FOR MORE INFORMATION,  
EXPLORE BELOW

- ↗ [Product Fact Sheet](#)
- ↗ [Images](#)
- ↗ [Architect Files](#)
- ↗ [Assembly Instructions](#)

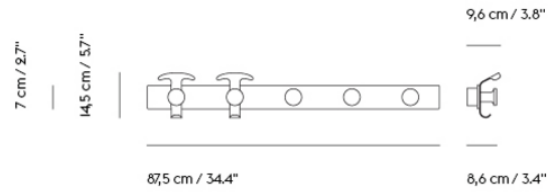
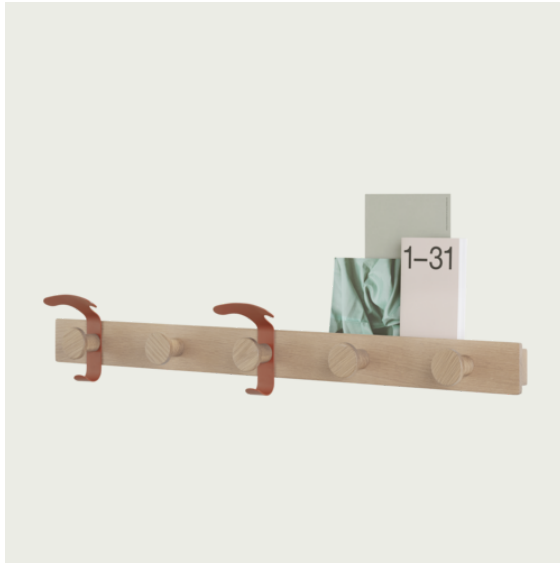

**Shipper Colli** 1  
**Gross Weight (kg)** 3.14  
**Net Weight (kg)** 2.26  
**Warranty Period** 5 years

Pattern No.	Color	Contract Price	Lead Time
<b>Ready-To-Ship US Warehouse</b>			
MPLCTRK-GREY-GREY	Grey/Grey	USD 278.00	-
MPLCTRK-OAK-BLCK	Oak/Black	USD 278.00	-
MPLCTRK-OAK-GREY	Oak/Grey	USD 278.00	-
MPLCTRK-OAK-CPBN	Oak/Copper Brown	USD 278.00	-

# COIL COAT RACK

FOR MORE INFORMATION,  
EXPLORE BELOW

- ↗ [Product Fact Sheet](#)
- ↗ [Images](#)
- ↗ [Architect Files](#)
- ↗ [Assembly Instructions](#)

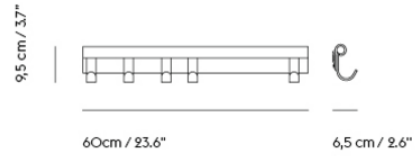

Shipper Colli 1  
 Gross Weight (kg) 2  
 Net Weight (kg) 1.4  
 Warranty Period 5 Years

Pattern No.	Color	Contract Price	Lead Time
<b>Ready-To-Ship US Warehouse</b>			
MCCTR24-BLCK	Black	USD 251.00	-
MCCTR24-DKGN	Dark Green	USD 251.00	-
MCCTR24-PLUM	Plum	USD 251.00	-
<b>Extras</b>			
MCCTRH-BLCK	Extra Coat Hook - Black	USD 36.00	-
MCCTRH-DKGN	Extra Coat Hook - Dark Green	USD 36.00	-
MCCTRH-PLUM	Extra Coat Hook - Plum	USD 36.00	-

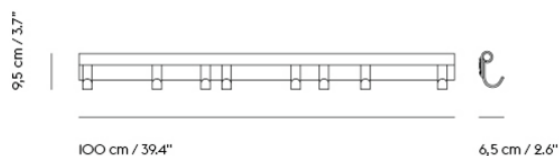

Shipper Colli 1  
 Gross Weight (kg) 3.3  
 Net Weight (kg) 2.4  
 Warranty Period 5 Years

Pattern No.	Color	Contract Price	Lead Time
<b>Ready-To-Ship US Warehouse</b>			
MCCTR39-BLCK	Black	USD 482.00	-
MCCTR39-DKGN	Dark Green	USD 482.00	-
MCCTR39-PLUM	Plum	USD 482.00	-
<b>Extras</b>			
MCCTRH-BLCK	Extra Coat Hook - Black	USD 36.00	-
MCCTRH-DKGN	Extra Coat Hook - Dark Green	USD 36.00	-
MCCTRH-PLUM	Extra Coat Hook - Plum	USD 36.00	-

# COMPILE BOOKEND

FOR MORE INFORMATION,  
EXPLORE BELOW

[↗ Product Fact Sheet](#)

[↗ Images](#)



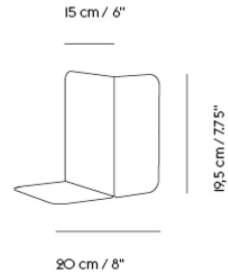

**Shipper Colli** 1  
**Gross Weight (kg)** 1.026  
**Net Weight (kg)** 0.8  
**Warranty Period** 5 years

Pattern No.	Color	Contract Price	Lead Time
<b>Ready-To-Ship US Warehouse</b>			
MCOMBK-GNBE	Beige-Green	USD 58.00	-
MCOMBK-GREY	Grey	USD 58.00	-
MCOMBK-PLUM	Plum	USD 58.00	-

# CORKY SERIES

FOR MORE INFORMATION,  
EXPLORE BELOW

- ↗ [Product Fact Sheet](#)
- ↗ [Images](#)
- ↗ [Product Declaration](#)

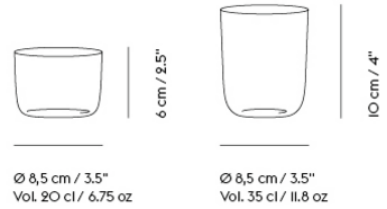

**Shipper Colli** 1  
**Gross Weight (kg)** 0.7  
**Net Weight (kg)** 0.66  
**Warranty Period** 5 years

Pattern No.	Color	Contract Price	Lead Time
<b>Ready-To-Ship US Warehouse</b>			
MCRKGLL-CLR	Clear - Low	USD 89.00	-
MCRKGLL-GREY	Grey - Low	USD 89.00	-
MCRKGLT-CLR	Clear - Tall	USD 100.00	-
MCRKGLT-GREY	Grey - Tall	USD 100.00	-

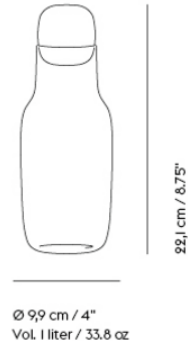

Shipper Colli |  
 Gross Weight (kg) |  
 Net Weight (kg) 0.4  
 Warranty Period 5 years

Pattern No.	Color	Contract Price	Lead Time
<b>Ready-To-Ship US Warehouse</b>			
MCRKCF-CLR	Clear	USD 100.00	-
MCRKCF-GREY	Grey	USD 100.00	-

# DOTS SERIES

FOR MORE INFORMATION,  
EXPLORE BELOW

- ↗ [Product Fact Sheet](#)
- ↗ [Images](#)
- ↗ [Architect Files](#)
- ↗ [Assembly Instructions](#)
- ↗ [Product Planner](#)

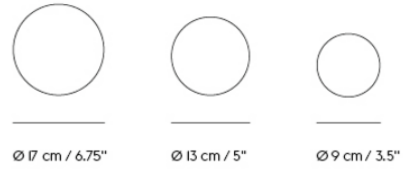

**Shipper Colli** 1  
**Gross Weight (kg)** 1.2  
**Net Weight (kg)** 0.77  
**Set of 5** Consists of 1x Ø 17 cm / 6.75", 1x Ø 13 cm / 5" and 3x Ø 9 cm / 3.5"  
**Warranty Period** 5 years

Pattern No.	Color	Contract Price	Lead Time
<b>Ready-To-Ship US Warehouse</b>			
MDOTSWSET-BLCK	Black	USD 156.00	-
MDOTSWSET-GREY	Grey ***	USD 156.00	-
MDOTSWSET-OAK	Oak	USD 156.00	-
MDOTSWSET-OWHT	Off-White	USD 156.00	-
<b>Extras</b>			
MDOTSWC	Screw for Dots Wood and Ceramic	USD 2.00	-

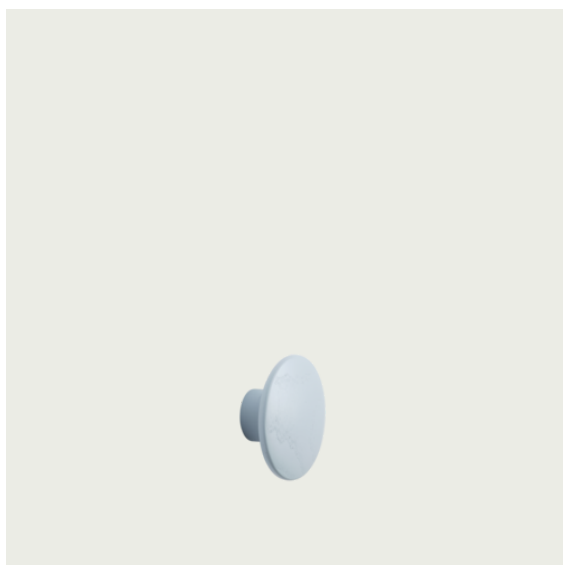

**Shipper Colli** 1  
**Gross Weight (kg)** 0.06  
**Net Weight (kg)** 0.036  
**Warranty Period** 5 years

Pattern No.	Color	Contract Price	Lead Time
<b>Ready-To-Ship US Warehouse</b>			
MDOTSW3-ASH	Ash	USD 27.00	-
MDOTSW3-BLCK	Black	USD 27.00	-
MDOTSW3-BRGR	Brown Green	USD 27.00	-
MDOTSW3-BURG	Burgundy	USD 27.00	-
MDOTSW3-BORG	Burnt Orange	USD 27.00	-
MDOTSW3-DKGN	Dark Green	USD 27.00	-
MDOTSW3-DKGY	Dark Grey	USD 27.00	-
MDOTSW3-DGRN	Dusty Green	USD 27.00	-
MDOTSW3-GREY	Grey ***	USD 27.00	-
MDOTSW3-LTBU	Light Blue	USD 27.00	-
MDOTSW3-MBLU	Midnight Blue	USD 27.00	-
MDOTSW3-MSTD	Mustard	USD 27.00	-
MDOTSW3-OAK	Oak	USD 27.00	-
MDOTSW3-OWHT	Off-White	USD 27.00	-
MDOTSW3-PABU	Pale Blue	USD 27.00	-
MDOTSW3-PETR	Petroleum	USD 27.00	-
MDOTSW3-SAGN	Sage Green ***	USD 27.00	-
MDOTSW3-STDB	Stained Dark Brown	USD 27.00	-
MDOTSW3-TAUP	Taupe	USD 27.00	-
MDOTSW3-WHIT	White ***	USD 27.00	-
MDOTSW3-WALN	Walnut	USD 39.00	-

Pattern No.	Color	Contract Price	Lead Time
<b>Extras</b>			
MDOTSWC	Screw for Dots Wood and Ceramic	USD 2.00	-



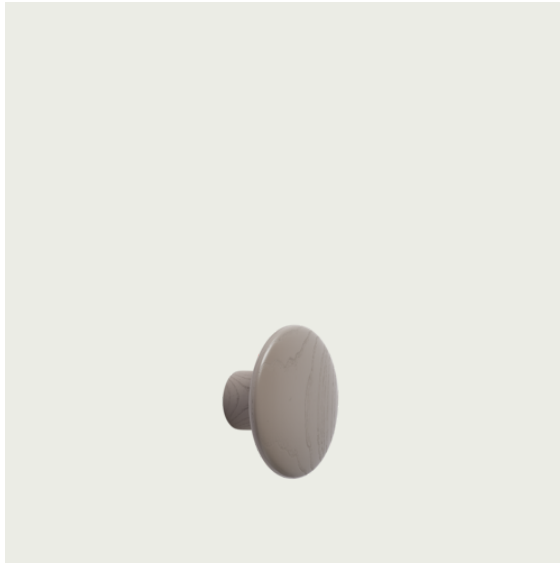

Ø 9 cm / 3.5"

**Shipper Colli** 1  
**Gross Weight (kg)** 0.123  
**Net Weight (kg)** 0.08  
**Warranty Period** 5 years

Pattern No.	Color	Contract Price	Lead Time
<b>Ready-To-Ship US Warehouse</b>			
MDOTSW4-ASH	Ash	USD 32.00	-
MDOTSW4-BLCK	Black	USD 32.00	-
MDOTSW4-BRGR	Brown Green	USD 32.00	-
MDOTSW4-BURG	Burgundy	USD 32.00	-
MDOTSW4-BORG	Burnt Orange	USD 32.00	-
MDOTSW4-DKGN	Dark Green	USD 32.00	-
MDOTSW4-DKGY	Dark Grey	USD 32.00	-
MDOTSW4-DGRN	Dusty Green	USD 32.00	-
MDOTSW4-GREY	Grey	USD 32.00	-
MDOTSW4-LTBU	Light Blue	USD 32.00	-
MDOTSW4-MBLU	Midnight Blue	USD 32.00	-
MDOTSW4-OAK	Oak	USD 32.00	-
MDOTSW4-OWHT	Off-White	USD 32.00	-
MDOTSW4-PABU	Pale Blue	USD 32.00	-
MDOTSW4-PETR	Petroleum ***	USD 32.00	-
MDOTSW4-SAGN	Sage Green ***	USD 32.00	-
MDOTSW4-STDB	Stained Dark Brown	USD 32.00	-
MDOTSW4-TAUP	Taupe	USD 32.00	-
MDOTSW4-WHIT	White ***	USD 32.00	-
<b>Extras</b>			
MDOTSWC	Screw for Dots Wood and Ceramic	USD 2.00	-

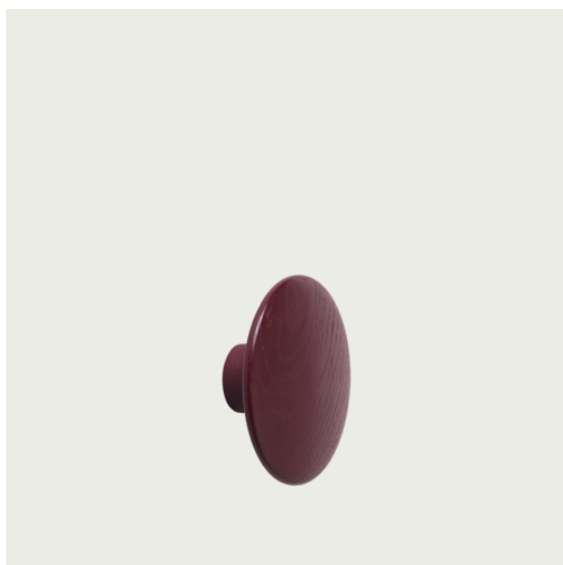

Ø 13 cm / 5"

**Shipper Colli** 1  
**Gross Weight (kg)** 0.3  
**Net Weight (kg)** 0.25  
**Warranty Period** 5 years

Pattern No.	Color	Contract Price	Lead Time
<b>Ready-To-Ship US Warehouse</b>			
MDOTSW5-ASH	Ash	USD 39.00	-
MDOTSW5-BLCK	Black	USD 39.00	-
MDOTSW5-BRGR	Brown Green	USD 39.00	-
MDOTSW5-BURG	Burgundy	USD 39.00	-
MDOTSW5-BORG	Burnt Orange	USD 39.00	-
MDOTSW5-DKGN	Dark Green	USD 39.00	-
MDOTSW5-DKGY	Dark Grey	USD 39.00	-
MDOTSW5-DGRN	Dusty Green	USD 39.00	-
MDOTSW5-GREY	Grey ***	USD 39.00	-
MDOTSW5-LTBU	Light Blue	USD 39.00	-
MDOTSW5-MBLU	Midnight Blue	USD 39.00	-
MDOTSW5-OAK	Oak	USD 39.00	-
MDOTSW5-OWHT	Off-White	USD 39.00	-
MDOTSW5-PABU	Pale Blue	USD 39.00	-
MDOTSW5-PETR	Petroleum	USD 39.00	-
MDOTSW5-SAGN	Sage Green	USD 39.00	-
MDOTSW5-STDB	Stained Dark Brown	USD 39.00	-
MDOTSW5-TAUP	Taupe	USD 39.00	-
MDOTSW5-WHIT	White ***	USD 39.00	-
MDOTSW5-WALN	Walnut ***	USD 68.00	-

Pattern No.	Color	Contract Price	Lead Time
<b>Ready-To-Ship EU Warehouse</b>			
MDOTSW5-BEGN	Beige-Green ***	USD 39.00	-
<b>Extras</b>			
MDOTSWC	Screw for Dots Wood and Ceramic	USD 2.00	-

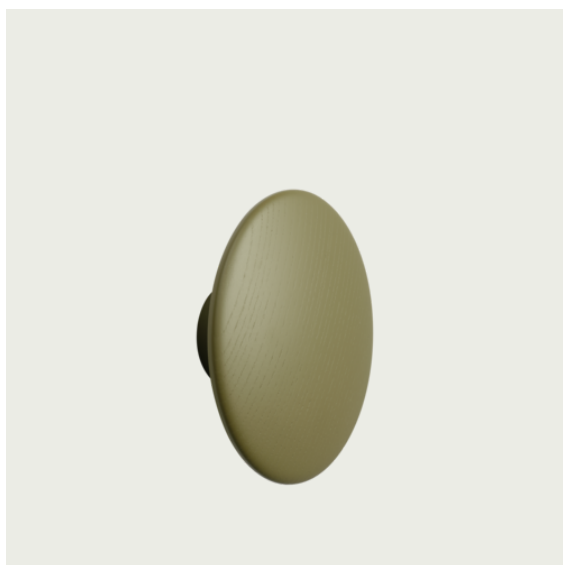

Ø 17 cm / 6.75"

**Shipper Colli** 1  
**Gross Weight (kg)** 0.5  
**Net Weight (kg)** 0.4  
**Warranty Period** 5 years

Pattern No.	Color	Contract Price	Lead Time
<b>Ready-To-Ship US Warehouse</b>			
MDOTSW7-ASH	Ash	USD 42.00	-
MDOTSW7-BLCK	Black	USD 42.00	-
MDOTSW7-BRGR	Brown Green	USD 42.00	-
MDOTSW7-BURG	Burgundy	USD 42.00	-
MDOTSW7-BORG	Burnt Orange	USD 42.00	-
MDOTSW7-DKGN	Dark Green	USD 42.00	-
MDOTSW7-DKGY	Dark Grey	USD 42.00	-
MDOTSW7-DGRN	Dusty Green	USD 42.00	-
MDOTSW7-GREY	Grey	USD 42.00	-
MDOTSW7-LTBU	Light Blue	USD 42.00	-
MDOTSW7-MBLU	Midnight Blue	USD 42.00	-
MDOTSW7-MSTD	Mustard ***	USD 42.00	-
MDOTSW7-OAK	Oak	USD 42.00	-
MDOTSW7-OWHT	Off-White	USD 42.00	-
MDOTSW7-PABU	Pale Blue	USD 42.00	-
MDOTSW7-PETR	Petroleum	USD 42.00	-
MDOTSW7-SAGN	Sage Green ***	USD 42.00	-
MDOTSW7-STDB	Stained Dark Brown	USD 42.00	-
MDOTSW7-TAUP	Taupe	USD 42.00	-
MDOTSW7-WHIT	White	USD 42.00	-
MDOTSW7-WALN	Walnut	USD 79.00	-

Pattern No.	Color	Contract Price	Lead Time
<b>Extras</b>			
MDOTSWC	Screw for Dots Wood and Ceramic	USD 2.00	-

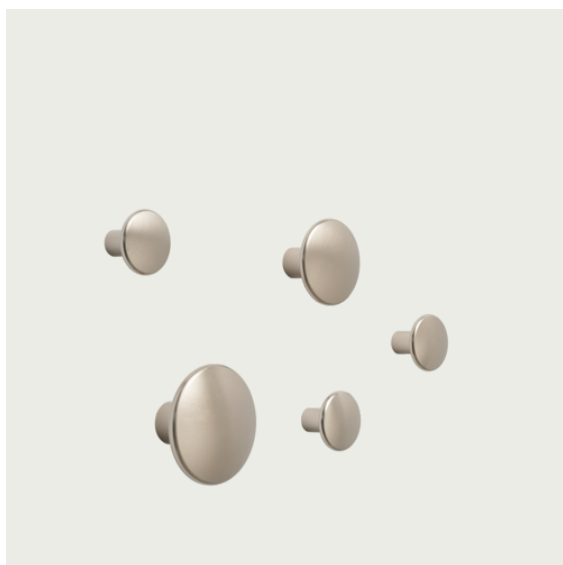

**Shipper Colli** 1  
**Gross Weight (kg)** 0.485  
**Net Weight (kg)** 0.15  
**Set of 5** Consists of 1x Ø 5 cm / 2", 1x Ø 3,9 cm / 1.5" and 3x Ø 2,7 cm / 1"  
**Warranty Period** 5 years

Pattern No.	Color	Contract Price	Lead Time
<b>Ready-To-Ship US Warehouse</b>			
MDOTSMSET-ALUM	Aluminum	USD 167.00	-
MDOTSMSET-BLCK	Black	USD 167.00	-
MDOTSMSET-BRAS	Brass	USD 167.00	-
MDOTSMSET-PABU	Pale Blue ***	USD 167.00	-
MDOTSMSET-TAUP	Taupe ***	USD 167.00	-
MDOTSMSET-UMBR	Umber	USD 167.00	-
<b>Ready-To-Ship EU Warehouse</b>			
MDOTSMSET-DKGN	Dark Green	USD 167.00	-
MDOTSMSET-ROSE	Rose	USD 167.00	-
<b>Extras</b>			
MDOTSMSS	Screw for Dots Metal	USD 9.00	-

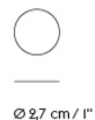
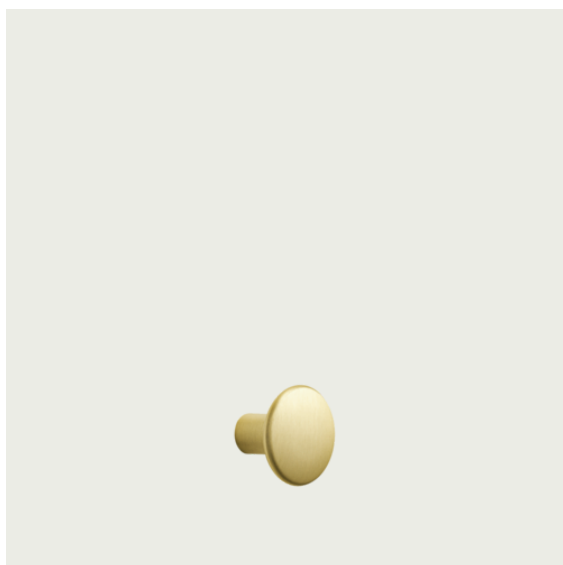

**Shipper Colli** 1  
**Gross Weight (kg)** 0.11  
**Net Weight (kg)** 0.02  
**Warranty Period** 5 years

Pattern No.	Color	Contract Price	Lead Time
<b>Ready-To-Ship US Warehouse</b>			
MDOTSM1-ALUM	Aluminum	USD 29.00	-
MDOTSM1-BLCK	Black	USD 29.00	-
MDOTSM1-BRAS	Brass	USD 29.00	-
MDOTSM1-DKGN	Dark Green	USD 29.00	-
MDOTSM1-LTGN	Light Green	USD 29.00	-
MDOTSM1-LILC	Lilac	USD 29.00	-
MDOTSM1-PABU	Pale Blue	USD 29.00	-
MDOTSM1-ROSE	Rose	USD 29.00	-
MDOTSM1-TAUP	Taupe	USD 29.00	-
MDOTSM1-UMBR	Umber	USD 29.00	-
<b>Extras</b>			
MDOTSMSS	Screw for Dots Metal	USD 9.00	-

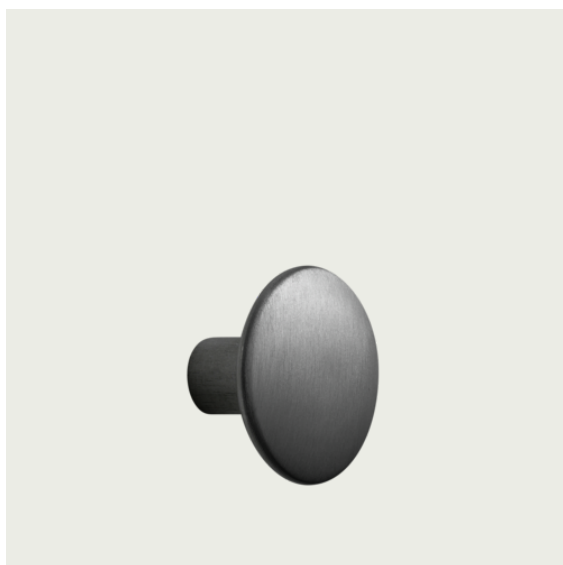

**Shipper Colli** 1  
**Gross Weight (kg)** 0.14  
**Net Weight (kg)** 0.04  
**Warranty Period** 5 years

Pattern No.	Color	Contract Price	Lead Time
<b>Ready-To-Ship US Warehouse</b>			
MDOTSM15-ALUM	Aluminum	USD 40.00	-
MDOTSM15-BLCK	Black	USD 40.00	-
MDOTSM15-BRAS	Brass	USD 40.00	-
MDOTSM15-DKGN	Dark Green	USD 40.00	-
MDOTSM15-LTGN	Light Green	USD 40.00	-
MDOTSM15-LILC	Lilac	USD 40.00	-
MDOTSM15-PABU	Pale Blue	USD 40.00	-
MDOTSM15-ROSE	Rose	USD 40.00	-
MDOTSM15-TAUP	Taupe	USD 40.00	-
MDOTSM15-UMBR	Umber	USD 40.00	-
<b>Extras</b>			
MDOTSMSS	Screw for Dots Metal	USD 9.00	-



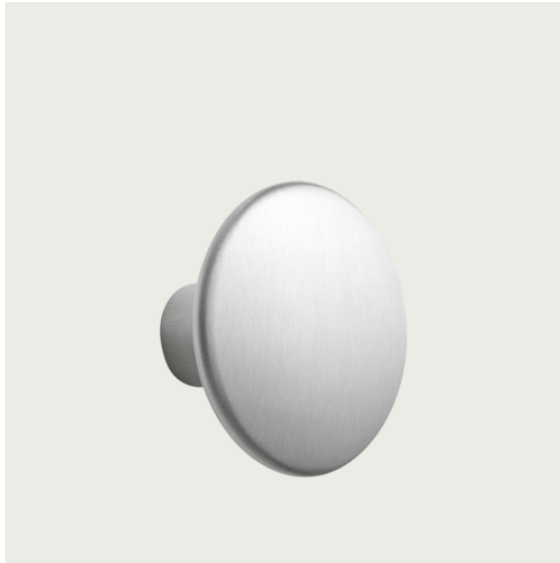

Ø 5 cm / 2"

**Shipper Colli** 1  
**Gross Weight (kg)** 0.24  
**Net Weight (kg)** 0.07  
**Warranty Period** 5 years

Pattern No.	Color	Contract Price	Lead Time
<b>Ready-To-Ship US Warehouse</b>			
MDOTSM2-ALUM	Aluminum	USD 52.00	-
MDOTSM2-BLCK	Black	USD 52.00	-
MDOTSM2-BRAS	Brass	USD 52.00	-
MDOTSM2-DKGN	Dark Green ***	USD 52.00	-
MDOTSM2-LTGN	Light Green	USD 52.00	-
MDOTSM2-LILC	Lilac	USD 52.00	-
MDOTSM2-PABU	Pale Blue ***	USD 52.00	-
MDOTSM2-ROSE	Rose	USD 52.00	-
MDOTSM2-TAUP	Taupe	USD 52.00	-
MDOTSM2-UMBR	Umber	USD 52.00	-
<b>Extras</b>			
MDOTSMSS	Screw for Dots Metal	USD 9.00	-

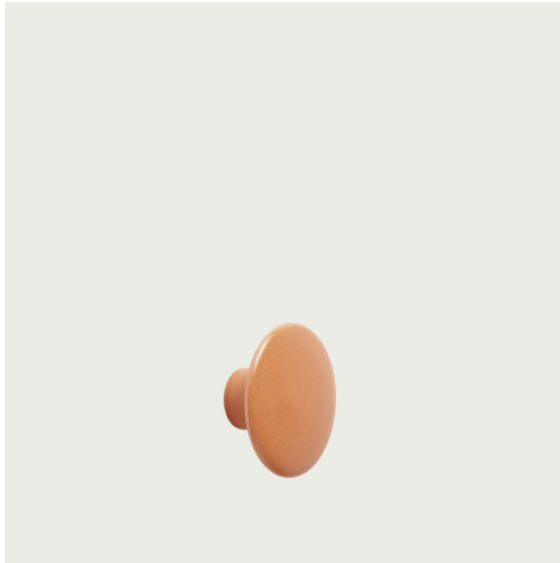

Ø 9 cm / 3.5"

Shipper Colli 1  
 Gross Weight (kg) 0.2  
 Net Weight (kg) 0.11  
 Warranty Period 5 years

Pattern No.	Color	Contract Price	Lead Time
<b>Ready-To-Ship US Warehouse</b>			
MDOTSC4-BORG	Burnt Orange	USD 44.00	-
MDOTSC4-LTBU	Light Blue	USD 44.00	-
MDOTSC4-ROSE	Rose ***	USD 44.00	-
<b>Extras</b>			
MDOTSWC	Screw for Dots Wood and Ceramic	USD 2.00	-

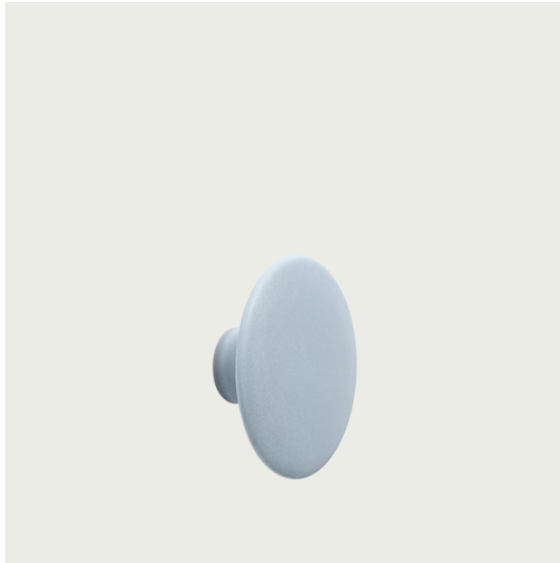

Ø 13 cm / 5"

**Shipper Colli** 1  
**Gross Weight (kg)** 0.3  
**Net Weight (kg)** 0.225  
**Warranty Period** 5 years

Pattern No.	Color	Contract Price	Lead Time
<b>Ready-To-Ship US Warehouse</b>			
MDOTSC5-BORG	Burnt Orange	USD 58.00	-
MDOTSC5-LTBU	Light Blue	USD 58.00	-
MDOTSC5-ROSE	Rose ***	USD 58.00	-
<b>Extras</b>			
MDOTSWC	Screw for Dots Wood and Ceramic	USD 2.00	-

# FOLDED SHELVES

FOR MORE INFORMATION,  
EXPLORE BELOW

- ↗ [Product Fact Sheet](#)
- ↗ [Images](#)
- ↗ [Architect Files](#)
- ↗ [Assembly Instructions](#)

# FOLDED SHELVES / 29,5 X 40 CM / 11.5 X 15.75"

610

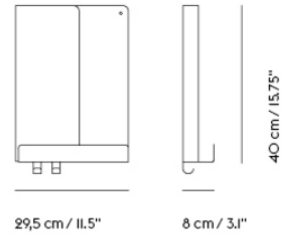

Shipper Colli	1
Gross Weight (kg)	3.5
Net Weight (kg)	2.8
Warranty Period	5 years

Pattern No.	Color	Contract Price	Lead Time
<b>Ready-To-Ship US Warehouse</b>			
MFLDSHXS-BLCK	Black	USD 177.00	-
MFLDSHXS-BUGY	Blue-Grey	USD 177.00	-
MFLDSHXS-BORG	Burnt Orange	USD 177.00	-
MFLDSHXS-DPRD	Deep Red	USD 177.00	-
MFLDSHXS-GREY	Grey	USD 177.00	-
MFLDSHXS-OLIV	Olive	USD 177.00	-

# FOLDED SHELVES / 51 X 22 CM / 20 X 8.75"

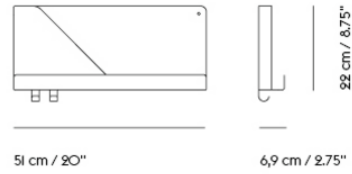

**Shipper Colli** 1  
**Gross Weight (kg)** 2.9  
**Net Weight (kg)** 2.35  
**Warranty Period** 5 years

Pattern No.	Color	Contract Price	Lead Time
<b>Ready-To-Ship US Warehouse</b>			
MFLDSHSM-BLCK	Black	USD 177.00	-
MFLDSHSM-BUGY	Blue-Grey	USD 177.00	-
MFLDSHSM-BORG	Burnt Orange	USD 177.00	-
MFLDSHSM-DPRD	Deep Red	USD 177.00	-
MFLDSHSM-GREY	Grey	USD 177.00	-
MFLDSHSM-OLIV	Olive	USD 177.00	-

# FOLDED SHELVES / 63 X 16,5 CM / 24.75 X 6.5"

612



63 cm / 24.75"



16,5 cm / 6.5"

12,4 cm / 4.75"

Shipper Colli	1
Gross Weight (kg)	3.4
Net Weight (kg)	2.85
Warranty Period	5 years

Pattern No.	Color	Contract Price	Lead Time
<b>Ready-To-Ship US Warehouse</b>			
MFLDSHMD-BLCK	Black	USD 251.00	-
MFLDSHMD-BUGY	Blue-Grey	USD 251.00	-
MFLDSHMD-BORG	Burnt Orange	USD 251.00	-
MFLDSHMD-DPRD	Deep Red	USD 251.00	-
MFLDSHMD-GREY	Grey	USD 251.00	-
MFLDSHMD-OLIV	Olive	USD 251.00	-



96 cm / 37.75"



13 cm / 5"

Shipper Colli 1  
 Gross Weight (kg) 4.2  
 Net Weight (kg) 3.55  
 Warranty Period 5 years

Pattern No.	Color	Contract Price	Lead Time
<b>Ready-To-Ship US Warehouse</b>			
MFLDShLG-BLCK	Black	USD 324.00	-
MFLDShLG-BUGY	Blue-Grey	USD 324.00	-
MFLDShLG-BORG	Burnt Orange	USD 324.00	-
MFLDShLG-DPRD	Deep Red	USD 324.00	-
MFLDShLG-GREY	Grey	USD 324.00	-
MFLDShLG-OLIV	Olive	USD 324.00	-



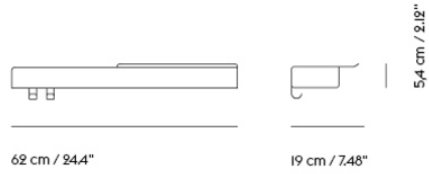

**Shipper Colli** 1  
**Gross Weight (kg)** 3.1  
**Net Weight (kg)** 2.3  
**Warranty Period** 5 years

Pattern No.	Color	Contract Price	Lead Time
<b>Ready-To-Ship US Warehouse</b>			
MFLDSHPLT-BLCK	Black	USD 324.00	-
MFLDSHPLT-BUGY	Blue-Grey	USD 324.00	-
MFLDSHPLT-BORG	Burnt Orange	USD 324.00	-
MFLDSHPLT-DPRD	Deep Red	USD 324.00	-
MFLDSHPLT-GREY	Grey	USD 324.00	-
MFLDSHPLT-OLIV	Olive	USD 324.00	-

# FRAMED MIRROR

FOR MORE INFORMATION,  
EXPLORE BELOW

- ↗ [Product Fact Sheet](#)
- ↗ [Images](#)
- ↗ [Architect Files](#)
- ↗ [Assembly Instructions](#)

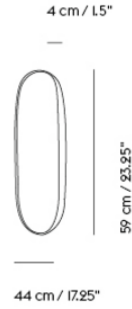
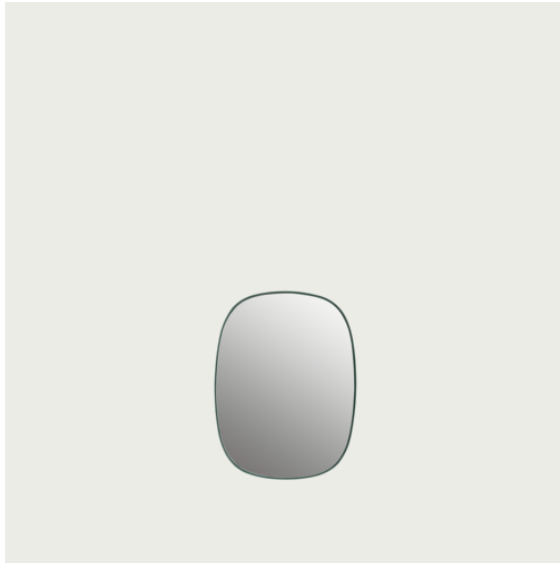

Shipper Colli 1  
 Gross Weight (kg) 8.5  
 Net Weight (kg) 5.5  
 Warranty Period 5 years

Pattern No.	Color	Contract Price	Lead Time
<b>Ready-To-Ship US Warehouse</b>			
MFRMMIRSM-ROSECL	Rose/Clear	USD 450.00	-
MFRMMIRSM-DKGNCL	Dark Green/Clear	USD 450.00	-
MFRMMIRSM-GREYCL	Grey/Clear	USD 450.00	-
MFRMMIRSM-ROSERE	Rose/Rose	USD 450.00	-
MFRMMIRSM-TAUPCL	Taupe/Clear	USD 450.00	-
MFRMMIRSM-TAUPTP	Taupe/Taupe	USD 450.00	-

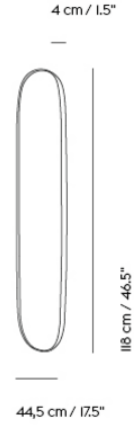

**Shipper Colli** 1  
**Gross Weight (kg)** 16.2  
**Net Weight (kg)** 11.8  
**Warranty Period** 5 years

Pattern No.	Color	Contract Price	Lead Time
<b>Ready-To-Ship US Warehouse</b>			
MFRMMIRLG-ROSECL	Rose/Clear	USD 849.00	-
MFRMMIRLG-DKGNCL	Dark Green/Clear	USD 849.00	-
MFRMMIRLG-GREYCL	Grey/Clear	USD 849.00	-
MFRMMIRLG-ROSERE	Rose/Rose	USD 849.00	-
MFRMMIRLG-TAUPCL	Taupe/Clear	USD 849.00	-
MFRMMIRLG-TAUPTP	Taupe/Taupe	USD 849.00	-

# GROOVE TRIVET

FOR MORE INFORMATION,  
EXPLORE BELOW

- ↗ [Product Fact Sheet](#)
- ↗ [Images](#)
- ↗ [Architect Files](#)

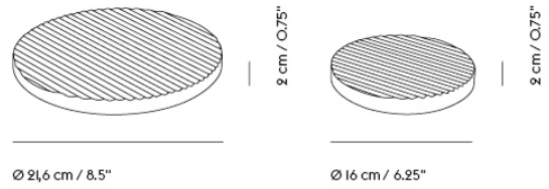

**Shipper Colli** |  
**Gross Weight (kg)** 1.45  
**Net Weight (kg)** 1.3  
**Warranty Period** 5 years

Pattern No.	Color	Contract Price	Lead Time
<b>Ready-To-Ship EU Warehouse</b>			
MGRVT6-GREN	Green - Ø 16 cm / 6.25"	USD 72.00	-
MGRVT6-GREY	Grey - Ø 16 cm / 6.25"	USD 72.00	-
MGRVT9-GREN	Green - Ø 21,6 cm / 8.5"	USD 100.00	-
MGRVT9-GREY	Grey - Ø 21,6 cm / 8.5"	USD 100.00	-

# KINK VASE

FOR MORE INFORMATION,  
EXPLORE BELOW

- ↗ [Product Fact Sheet](#)
- ↗ [Images](#)
- ↗ [Architect Files](#)

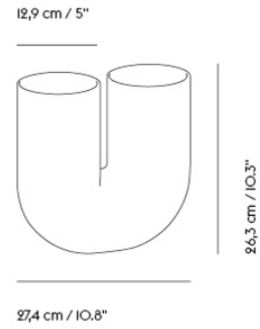

**Shipper Colli** 1  
**Gross Weight (kg)** 2.4  
**Net Weight (kg)** 1.946  
**Warranty Period** 5 years

Pattern No.	Color	Contract Price	Lead Time
<b>Ready-To-Ship US Warehouse</b>			
MKINVS-DLIL	Dusty Lilac	USD 383.00	-
MKINVS-LTBU	Light Blue	USD 383.00	-
MKINVS-SAND	Sand	USD 383.00	-



# LAYER CUSHION

FOR MORE INFORMATION,  
EXPLORE BELOW

[↗ Product Fact Sheet](#)

[↗ Images](#)

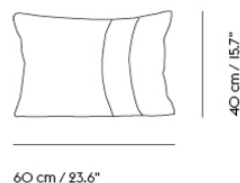

Shipper Colli |  
 Gross Weight (kg) 0.65  
 Net Weight (kg) 0.6  
 Warranty Period 5 years

Pattern No.	Color	Contract Price	Lead Time
<b>Ready-To-Ship US Warehouse</b>			
MLAYCUS1624-DKGN	Dark Green ***	USD 146.00	-
MLAYCUS1624-DKGY	Dark Grey ***	USD 146.00	-
MLAYCUS1624-SDGY	Sand-Grey ***	USD 146.00	-
<b>Ready-To-Ship EU Warehouse</b>			
MLAYCUS1624-MBLU	Midnight Blue ***	USD 146.00	-

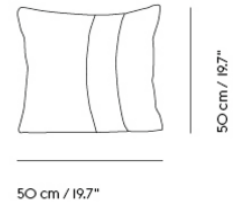

Shipper Colli 1  
 Gross Weight (kg) 0.65  
 Net Weight (kg) 0.6  
 Warranty Period 5 years

Pattern No.	Color	Contract Price	Lead Time
<b>Ready-To-Ship US Warehouse</b>			
MLAYCUS2020-DKGY	Dark Grey ***	USD 146.00	-
MLAYCUS2020-DROS	Dusty Rose ***	USD 146.00	-
MLAYCUS2020-MBLU	Midnight Blue ***	USD 146.00	-
MLAYCUS2020-SDGY	Sand-Grey ***	USD 146.00	-
<b>Ready-To-Ship EU Warehouse</b>			
MLAYCUS2020-DKGN	Dark Green ***	USD 146.00	-

# MERE BOWL

FOR MORE INFORMATION,  
EXPLORE BELOW

- ↗ [Product Fact Sheet](#)
- ↗ [Images](#)
- ↗ [Architect Files](#)
- ↗ [Product Declaration](#)

# MERE BOWL / 51,5 X 21,5 CM / 20.5 X 8.5"

626

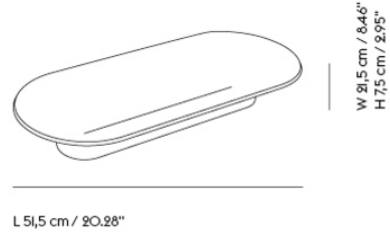

**Shipper Colli** 1  
**Gross Weight (kg)** 3  
**Net Weight (kg)** 2.3  
**Warranty Period** 5 years

Pattern No.	Color	Contract Price	Lead Time
<b>Ready-To-Ship US Warehouse</b>			
MMERBWL2109-BRGR	Brown Green	USD 226.00	-
MMERBWL2109-LTGN	Light Green	USD 226.00	-
MMERBWL2109-OWHT	Off-White	USD 226.00	-

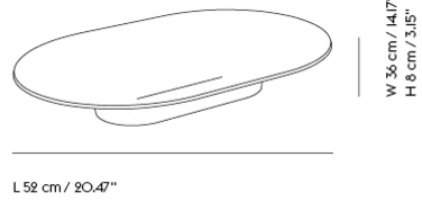

Shipper Colli	1
Gross Weight (kg)	4.2
Net Weight (kg)	3.1
Warranty Period	5 years

Pattern No.	Color	Contract Price	Lead Time
<b>Ready-To-Ship US Warehouse</b>			
MMERBWL2115-BRGR	Brown Green	USD 278.00	-
MMERBWL2115-LTGN	Light Green	USD 278.00	-
MMERBWL2115-OWHT	Off-White	USD 278.00	-

# MINGLE CUSHION

FOR MORE INFORMATION,  
EXPLORE BELOW

- ↗ [Product Fact Sheet](#)
- ↗ [Images](#)
- ↗ [Architect Files](#)
- ↗ [Assembly Instructions](#)

# MINGLE CUSHION / 45 X 45 CM / 17.7 X 17.7"

629

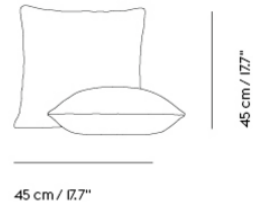

Shipper Colli	1
Gross Weight (kg)	0.541
Net Weight (kg)	0.534
Warranty Period	5 years

Pattern No.	Color	Contract Price	Lead Time
<b>Ready-To-Ship US Warehouse</b>			
MMNGCUS1818-CPBNLTBU	Copper Brown / Light Blue	USD 163.00	-
MMNGCUS1818-LTBUMINT	Light Blue / Mint	USD 163.00	-
MMNGCUS1818-LIGN	Light Green	USD 163.00	-
MMNGCUS1818-LIYW	Light Yellow	USD 163.00	-
MMNGCUS1818-MBLU	Midnight Blue	USD 163.00	-
MMNGCUS1818-PETRROSE	Rose / Petroleum	USD 163.00	-
MMNGCUS1818-SANDLILC	Sand / Lilac	USD 163.00	-
MMNGCUS1818-TAUP	Taupe	USD 163.00	-



# MINGLE CUSHION / 35 X 55 CM / 13.7 X 21.7"

630



**Shipper Colli** |  
**Gross Weight (kg)** 0.539  
**Net Weight (kg)** 0.532  
**Warranty Period** 5 years

Pattern No.	Color	Contract Price	Lead Time
<b>Ready-To-Ship US Warehouse</b>			
MMNGCUS1422-CPBNLTBU	Copper Brown / Light Blue	USD 163.00	-
MMNGCUS1422-LTBUMINT	Light Blue / Mint	USD 163.00	-
MMNGCUS1422-LIGN	Light Green	USD 163.00	-
MMNGCUS1422-LIYW	Light Yellow	USD 163.00	-
MMNGCUS1422-MBLU	Midnight Blue	USD 163.00	-
MMNGCUS1422-PETROSE	Rose / Petroleum	USD 163.00	-
MMNGCUS1422-SANDLILC	Sand / Lilac	USD 163.00	-
MMNGCUS1422-TAUP	Taupe	USD 163.00	-

# PEBBLE RUG

FOR MORE INFORMATION,  
EXPLORE BELOW

[↗ Product Fact Sheet](#)

[↗ Images](#)

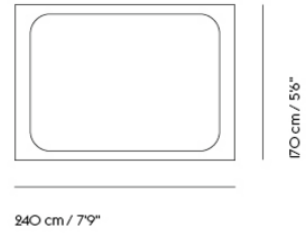

**Shipper Colli** 1  
**Gross Weight (kg)** 18.4  
**Net Weight (kg)** 17.8  
**Warranty Period** 5 years

Pattern No.	Color	Contract Price	Lead Time
<b>Ready-To-Ship US Warehouse</b>			
MPEBRG6693-BRGR	Brown Green	USD 1,675.00	-
MPEBRG6693-BORG	Burnt Orange	USD 1,675.00	-
MPEBRG6693-DKGY	Dark Grey	USD 1,675.00	-
MPEBRG6693-LTGY	Light Grey	USD 1,675.00	-
MPEBRG6693-PABU	Pale Blue	USD 1,675.00	-
MPEBRG6693-PROS	Pale Rose	USD 1,675.00	-

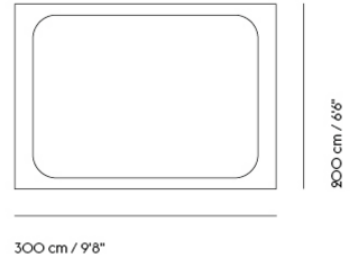

**Shipper Colli** 1  
**Gross Weight (kg)** 24.3  
**Net Weight (kg)** 22.1  
**Warranty Period** 5 years

Pattern No.	Color	Contract Price	Lead Time
<b>Ready-To-Ship US Warehouse</b>			
MPEBRG78116-BRGR	Brown Green	USD 2,620.00	-
MPEBRG78116-BORG	Burnt Orange	USD 2,620.00	-
MPEBRG78116-LTGY	Light Grey	USD 2,620.00	-
MPEBRG78116-PABU	Pale Blue	USD 2,620.00	-
MPEBRG78116-PROS	Pale Rose	USD 2,620.00	-

# PLATFORM TRAY

FOR MORE INFORMATION,  
EXPLORE BELOW

- ↗ [Product Fact Sheet](#)
- ↗ [Images](#)
- ↗ [Architect Files](#)
- ↗ [Assembly Instructions](#)

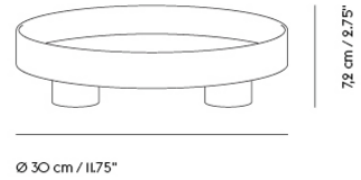

Shipper Colli 1  
 Gross Weight (kg) 0.9  
 Net Weight (kg) 0.65  
 Warranty Period 5 years

Pattern No.	Color	Contract Price	Lead Time
<b>Ready-To-Ship US Warehouse</b>			
MPLTTY-BUGY	Blue Grey	USD 114.00	-
MPLTTY-DKGN	Dark Green	USD 114.00	-
MPLTTY-DKRD	Dark Red	USD 114.00	-
MPLTTY-GREY	Grey	USD 114.00	-

# PLY RUG SERIES

FOR MORE INFORMATION,  
EXPLORE BELOW

[↗ Product Fact Sheet](#)

[↗ Images](#)

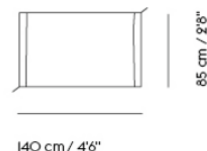

**Shipper Colli** 1  
**Gross Weight (kg)** 3.4  
**Net Weight (kg)** 2.9  
**Warranty Period** 5 years

Pattern No.	Color	Contract Price	Lead Time
<b>Ready-To-Ship US Warehouse</b>			
MPLYRG3254-BLWH	Black/White	USD 356.00	-
MPLYRG3254-BORG	Burnt Orange	USD 356.00	-
MPLYRG3254-DKGY	Dark Grey ***	USD 356.00	-
MPLYRG3254-GREY	Grey	USD 356.00	-
MPLYRG3254-LROS	Light Rose	USD 356.00	-
MPLYRG3254-MBLU	Midnight Blue ***	USD 356.00	-
MPLYRG3254-OWHT	Off-White	USD 356.00	-
MPLYRG3254-ROSE	Rose ***	USD 356.00	-
MPLYRG3254-YELW	Yellow	USD 356.00	-
<b>Extras</b>			
MPLYPA3254	Rug Pad - 75 x 130 cm / 2'5 x 4'3"	USD 44.00	-



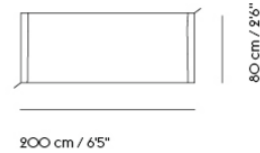

**Shipper Colli** 1  
**Gross Weight (kg)** 3.8  
**Net Weight (kg)** 2.9  
**Warranty Period** 5 years

Pattern No.	Color	Contract Price	Lead Time
<b>Ready-To-Ship US Warehouse</b>			
MPLYRG3077-BLWH	Black/White	USD 450.00	-
MPLYRG3077-BORG	Burnt Orange	USD 450.00	-
MPLYRG3077-DKGY	Dark Grey ***	USD 450.00	-
MPLYRG3077-GREY	Grey	USD 450.00	-
MPLYRG3077-LROS	Light Rose	USD 450.00	-
MPLYRG3077-MBLU	Midnight Blue ***	USD 450.00	-
MPLYRG3077-OWHT	Off-White	USD 450.00	-
MPLYRG3077-ROSE	Rose ***	USD 450.00	-
MPLYRG3077-YELW	Yellow	USD 450.00	-
<b>Extras</b>			
MPLYPA3077	Rug Pad - 70 x 190 cm / 2'3 x 6'2"	USD 68.00	-

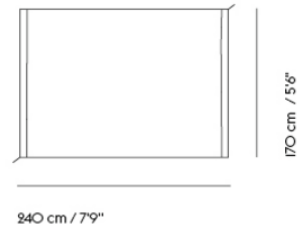

**Shipper Colli** 1  
**Gross Weight (kg)** 10.5  
**Net Weight (kg)** 8.6  
**Warranty Period** 5 years

Pattern No.	Color	Contract Price	Lead Time
<b>Ready-To-Ship US Warehouse</b>			
MPLYRG6681-BLWH	Black/White	USD 1,028.00	-
MPLYRG6681-BORG	Burnt Orange	USD 1,028.00	-
MPLYRG6681-DKGY	Dark Grey ***	USD 1,028.00	-
MPLYRG6681-GREY	Grey	USD 1,028.00	-
MPLYRG6681-LROS	Light Rose	USD 1,028.00	-
MPLYRG6681-MBLU	Midnight Blue	USD 1,028.00	-
MPLYRG6681-OWHT	Off-White	USD 1,028.00	-
MPLYRG6681-ROSE	Rose	USD 1,028.00	-
MPLYRG6681-YELW	Yellow	USD 1,028.00	-
<b>Extras</b>			
MPLYPA6681	Rug Pad - 160 x 230 cm / 5'2 x 7'5"	USD 89.00	-

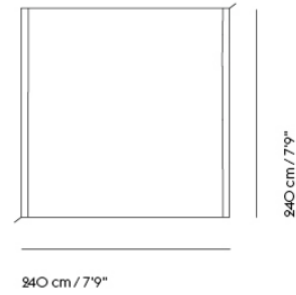

Shipper Colli	1
Gross Weight (kg)	16.2
Net Weight (kg)	15.55
Warranty Period	5 years

Pattern No.	Color	Contract Price	Lead Time
<b>Ready-To-Ship US Warehouse</b>			
MPLYRG8181-BLWH	Black/White	USD 1,360.00	-
MPLYRG8181-BORG	Burnt-Orange	USD 1,360.00	-
MPLYRG8181-GREY	Grey	USD 1,360.00	-
MPLYRG8181-LROS	Light Rose	USD 1,360.00	-
MPLYRG8181-OWHT	Off-White	USD 1,360.00	-
MPLYRG8181-YELW	Yellow	USD 1,360.00	-

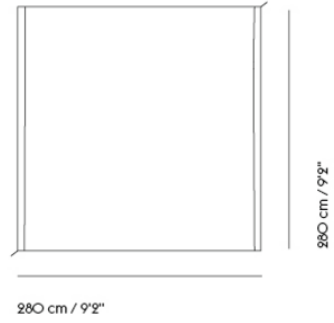

Shipper Colli	1
Gross Weight (kg)	22
Net Weight (kg)	21.2
Warranty Period	5 years

Pattern No.	Color	Contract Price	Lead Time
<b>Ready-To-Ship US Warehouse</b>			
MPLYRG110110-BLWH	Black-White	USD 1,885.00	-
MPLYRG110110-BORG	Burnt Orange	USD 1,885.00	-
MPLYRG110110-GREY	Grey	USD 1,885.00	-
MPLYRG110110-LROS	Light Rose	USD 1,885.00	-
MPLYRG110110-OWHT	Off-White	USD 1,885.00	-
MPLYRG110110-YELW	Yellow	USD 1,885.00	-

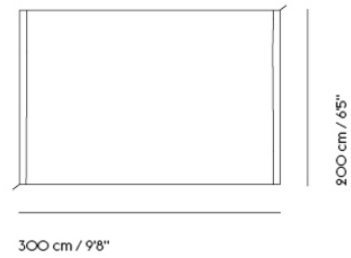

**Shipper Colli** 1  
**Gross Weight (kg)** 14.7  
**Net Weight (kg)** 12.8  
**Warranty Period** 5 years

Pattern No.	Color	Contract Price	Lead Time
<b>Ready-To-Ship US Warehouse</b>			
MPLYRG78116-BLWH	Black/White	USD 1,626.00	-
MPLYRG78116-BORG	Burnt Orange	USD 1,626.00	-
MPLYRG78116-DKGY	Dark Grey	USD 1,626.00	-
MPLYRG78116-GREY	Grey	USD 1,626.00	-
MPLYRG78116-LROS	Light Rose	USD 1,626.00	-
MPLYRG78116-MBLU	Midnight Blue ***	USD 1,626.00	-
MPLYRG78116-OWHT	Off-White	USD 1,626.00	-
MPLYRG78116-ROSE	Rose	USD 1,626.00	-
MPLYRG78116-YELW	Yellow	USD 1,626.00	-
<b>Extras</b>			
MPLYPA78116	Rug Pad - 190 x 290 cm / 6'2 x 9'5"	USD 110.00	-

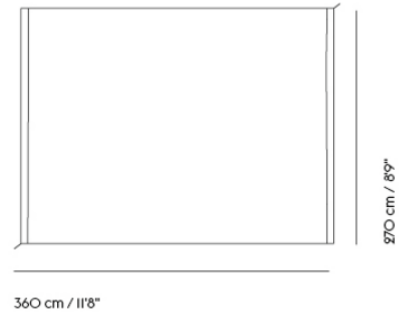

**Shipper Colli** 1  
**Gross Weight (kg)** 24.3  
**Net Weight (kg)** 20.6  
**Warranty Period** 5 years

Pattern No.	Color	Contract Price	Lead Time
<b>Ready-To-Ship US Warehouse</b>			
MPLYRG104140-BLWH	Black/White	USD 2,571.00	-
MPLYRG104140-DKGY	Dark Grey ***	USD 2,571.00	-
MPLYRG104140-GREY	Grey	USD 2,571.00	-
MPLYRG104140-LROS	Light Rose	USD 2,571.00	-
MPLYRG104140-OWHT	Off-White	USD 2,571.00	-
MPLYRG104140-ROSE	Rose ***	USD 2,571.00	-
MPLYRG104140-YELW	Yellow	USD 2,571.00	-
<b>Extras</b>			
MPLYPA104140	Rug Pad - 260 x 350 cm / 8'5 x 11'5"	USD 226.00	-

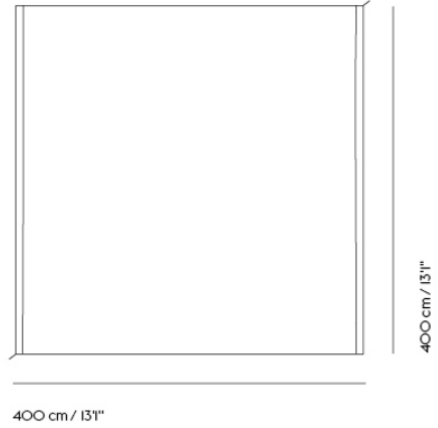

**Shipper Colli** 1  
**Gross Weight (kg)** 42.8  
**Net Weight (kg)** 34.1  
**Warranty Period** 5 years

Pattern No.	Color	Contract Price	Lead Time
<b>Ready-To-Ship US Warehouse</b>			
MPLYRG157157-MBLU	Midnight Blue ***	USD 4,090.00	-
MPLYRG157157-OWHT	Off-White ***	USD 4,090.00	-
MPLYRG157157-ROSE	Rose ***	USD 4,090.00	-
<b>Extras</b>			
MPLYPA157157	Rug Pad - 380 x 380 cm / 12'5 x 12'5" ***	USD 345.00	-

# RAISE SERIES

FOR MORE INFORMATION,  
EXPLORE BELOW

- ↗ [Product Fact Sheet](#)
- ↗ [Images](#)
- ↗ [Architect Files](#)
- ↗ [Product Declaration](#)



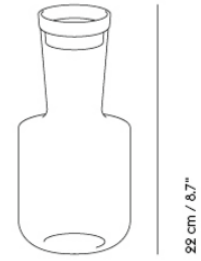

Ø 11 cm / 4.3"  
Vol. 1 liter / 33.8 oz

Shipper Colli 1  
Gross Weight (kg) 0.85  
Net Weight (kg) 0.21  
Warranty Period 5 Years

Pattern No.	Color	Contract Price	Lead Time
<b>Ready-To-Ship US Warehouse</b>			
MRSECF-BORG	Burnt Orange	USD 110.00	-
MRSECF-CLR	Clear	USD 110.00	-
MRSECF-DKBU	Dark Blue	USD 110.00	-

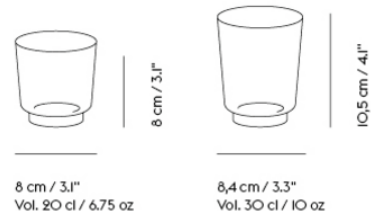
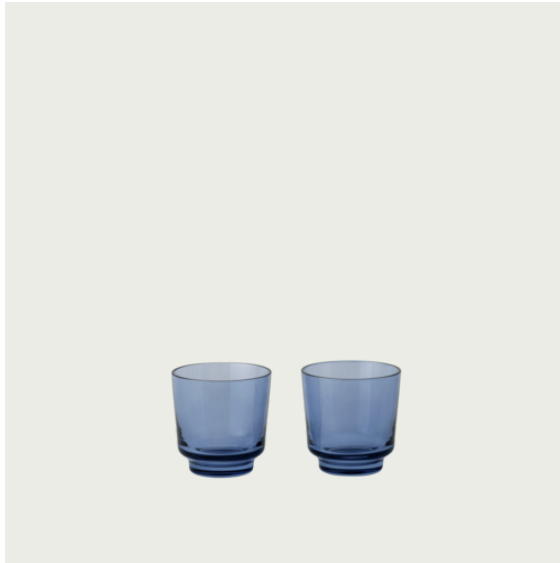

Shipper Colli 1  
 Gross Weight (kg) 0.46  
 Net Weight (kg) 0.13  
 Warranty Period 5 Years

Pattern No.	Color	Contract Price	Lead Time
<b>Ready-To-Ship US Warehouse</b>			
MRSEGL20-BORG	Burnt Orange - 20 cl	USD 58.00	-
MRSEGL20-CLR	Clear - 20 cl	USD 58.00	-
MRSEGL20-DKBU	Dark Blue - 20 cl	USD 58.00	-
MRSEGL30-BORG	Burnt Orange - 30 cl	USD 68.00	-
MRSEGL30-CLR	Clear - 30 cl	USD 68.00	-
MRSEGL30-DKBU	Dark Blue - 30 cl	USD 68.00	-

# REDUCE PAPER BIN

FOR MORE INFORMATION,  
EXPLORE BELOW

- ↗ [Product Fact Sheet](#)
- ↗ [Images](#)
- ↗ [Architect Files](#)
- ↗ [Product Declaration](#)

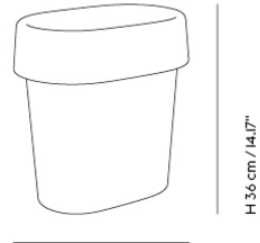

W 25,1 cm / 9.88"  
 D 23,6 cm / 9.29"  
 Vol. 14 liter / 3.7 gal

Shipper Colli 1  
 Gross Weight (kg) 1.7  
 Net Weight (kg) 1.36  
 Warranty Period 5 years

Pattern No.	Color	Contract Price	Lead Time
<b>Ready-To-Ship US Warehouse</b>			
MRPBN-ANTH	Anthracite	USD 79.00	-
MRPBN-DKRD	Dark Red	USD 79.00	-
MRPBN-GREY	Grey	USD 79.00	-
MRPBN-LTGN	Light Green	USD 79.00	-

# RELEVO RUG

FOR MORE INFORMATION,  
EXPLORE BELOW

[↗ Product Fact Sheet](#)

[↗ Images](#)

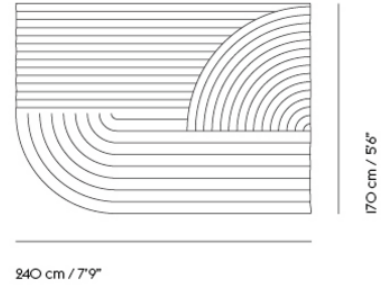

**Shipper Colli** 1  
**Gross Weight (kg)** 21  
**Net Weight (kg)** 19  
**Warranty Period** 5 Years

Pattern No.	Color	Contract Price	Lead Time
<b>Ready-To-Ship US Warehouse</b>			
MRELVRG6693-BORG	Burnt Orange	USD 1,626.00	-
MRELVRG6693-DKGN	Dark Green	USD 1,626.00	-
MRELVRG6693-OWHT	Off-White	USD 1,626.00	-
MRELVRG6693-SAGN	Sage Green	USD 1,626.00	-

# RELEVO RUG / 200 X 300 CM / 6'5" X 9'8"

652

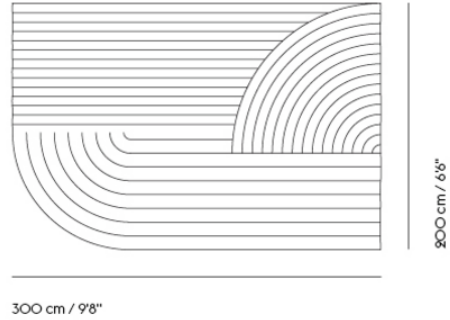
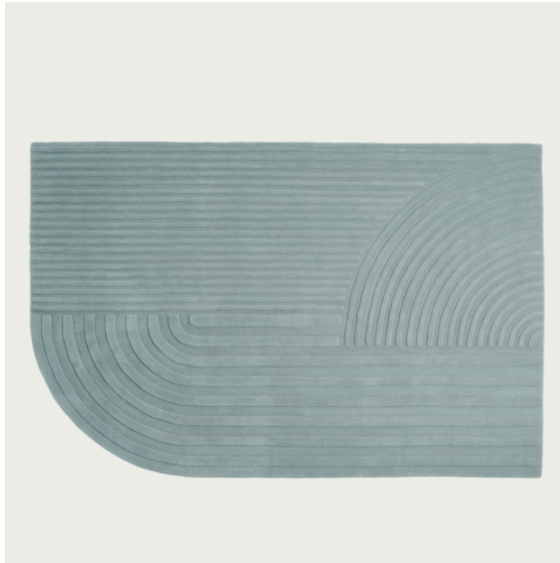

**Shipper Colli** 1  
**Gross Weight (kg)** 30  
**Net Weight (kg)** 28  
**Warranty Period** 5 Years

Pattern No.	Color	Contract Price	Lead Time
<b>Ready-To-Ship US Warehouse</b>			
MRELVRG78116-BORG	Burnt Orange	USD 2,620.00	-
MRELVRG78116-DKGN	Dark Green	USD 2,620.00	-
MRELVRG78116-OWHT	Off-White	USD 2,620.00	-
MRELVRG78116-SAGN	Sage Green	USD 2,620.00	-

# RESTORE SERIES

FOR MORE INFORMATION,  
EXPLORE BELOW

- ↗ Product Fact Sheet
- ↗ Images
- ↗ Architect Files
- ↗ Assembly Instructions



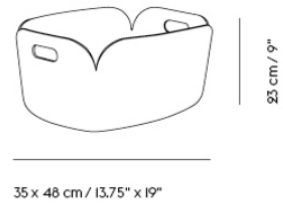

**Shipper Colli** 1  
**Gross Weight (kg)** 0.9  
**Net Weight (kg)** 0.8  
**Warranty Period** 5 years

Pattern No.	Color	Contract Price	Lead Time
<b>Ready-To-Ship US Warehouse</b>			
MRESBKR-BEGN	Beige-Green	USD 167.00	-
MRESBKR-BLME	Black Mélange	USD 167.00	-
MRESBKR-BRGR	Brown Green	USD 167.00	-
MRESBKR-BORG	Burnt Orange	USD 167.00	-
MRESBKR-DKBW	Dark Brown	USD 167.00	-
MRESBKR-DKGN	Dark Green	USD 167.00	-
MRESBKR-DGRN	Dusty Green	USD 167.00	-
MRESBKR-DLAC	Dusty Lilac	USD 167.00	-
MRESBKR-GREY	Grey Mélange	USD 167.00	-
MRESBKR-LTBU	Light Blue	USD 167.00	-
MRESBKR-MBLU	Midnight Blue	USD 167.00	-
MRESBKR-SAND	Sand	USD 167.00	-

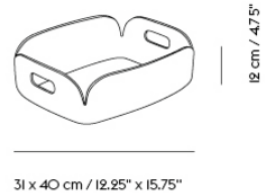

**Shipper Colli** 1  
**Gross Weight (kg)** 0.55  
**Net Weight (kg)** 0.5  
**Warranty Period** 5 years

Pattern No.	Color	Contract Price	Lead Time
<b>Ready-To-Ship US Warehouse</b>			
MRESTR-BLME	Black Mélange	USD 142.00	-
MRESTR-BRGR	Brown Green	USD 142.00	-
MRESTR-DGRN	Dusty Green	USD 142.00	-
MRESTR-GREY	Grey Mélange	USD 142.00	-
MRESTR-LTBU	Light Blue	USD 142.00	-
MRESTR-MBLU	Midnight Blue	USD 142.00	-
MRESTR-SAND	Sand	USD 142.00	-

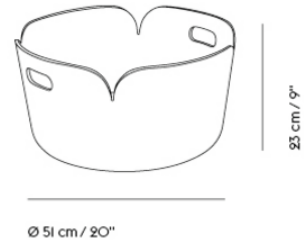

Shipper Colli	1
Gross Weight (kg)	1.2
Net Weight (kg)	1.2
Warranty Period	5 years

Pattern No.	Color	Contract Price	Lead Time
<b>Ready-To-Ship US Warehouse</b>			
MRESBKO-AQUA	Aqua ***	USD 184.00	-
MRESBKO-BLME	Black Mélange	USD 184.00	-
MRESBKO-BRGR	Brown Green	USD 184.00	-
MRESBKO-DGRN	Dusty Green	USD 184.00	-
MRESBKO-GREY	Grey Mélange	USD 184.00	-
MRESBKO-MBLU	Midnight Blue	USD 184.00	-

# RHYTHM THROW

FOR MORE INFORMATION,  
EXPLORE BELOW

[↗ Product Fact Sheet](#)

[↗ Images](#)

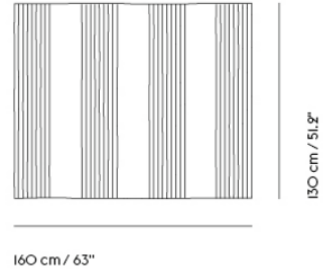

Shipper Colli |  
 Net Weight (kg) 0.9  
 Warranty Period 5 years

Pattern No.	Color	Contract Price	Lead Time
<b>Ready-To-Ship EU Warehouse</b>			
MRHYTH-DKGN	Dark Green ***	USD 362.00	-

# RIDGE SERIES

FOR MORE INFORMATION,  
EXPLORE BELOW

- ↗ [Product Fact Sheet](#)
- ↗ [Images](#)
- ↗ [Architect Files](#)

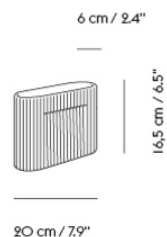
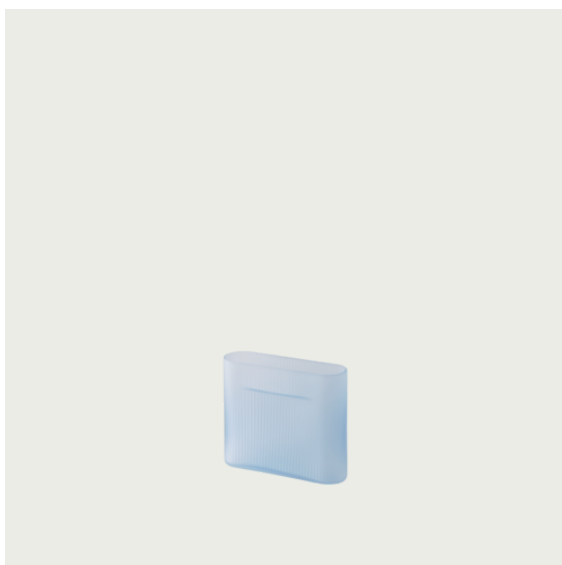

**Shipper Colli** |  
**Gross Weight (kg)** |  
**Net Weight (kg)** 0.75  
**Warranty Period** 5 years

Pattern No.	Color	Contract Price	Lead Time
<b>Ready-To-Ship US Warehouse</b>			
MRIDVS7-BEIG	Beige	USD 93.00	-
MRIDVS7-OWHT	Off-White	USD 93.00	-
MRIDVS7-TERR	Terracotta	USD 93.00	-

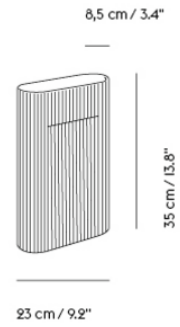

**Shipper Colli** 1  
**Gross Weight (kg)** 2.5  
**Net Weight (kg)** 1.8  
**Warranty Period** 5 years

Pattern No.	Color	Contract Price	Lead Time
<b>Ready-To-Ship US Warehouse</b>			
MRIDVS14-BEIG	Beige	USD 146.00	-
MRIDVS14-OWHT	Off-White	USD 146.00	-
MRIDVS14-TERR	Terracotta ***	USD 146.00	-



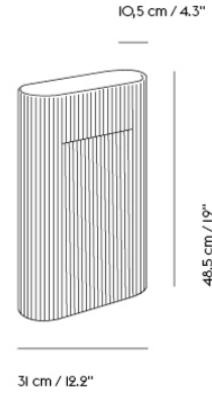

**Shipper Colli** 1  
**Gross Weight (kg)** 4.8  
**Net Weight (kg)** 4.4  
**Warranty Period** 5 years

Pattern No.	Color	Contract Price	Lead Time
<b>Ready-To-Ship US Warehouse</b>			
MRIDVS19-BEIG	Beige	USD 278.00	-
MRIDVS19-OWHT	Off-White	USD 278.00	-
MRIDVS19-TERR	Terracotta	USD 278.00	-

# SILENT VASE

FOR MORE INFORMATION,  
EXPLORE BELOW

- ↗ [Product Fact Sheet](#)
- ↗ [Images](#)
- ↗ [Architect Files](#)
- ↗ [Assembly Instructions](#)

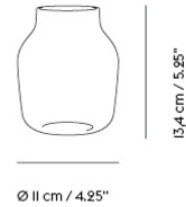
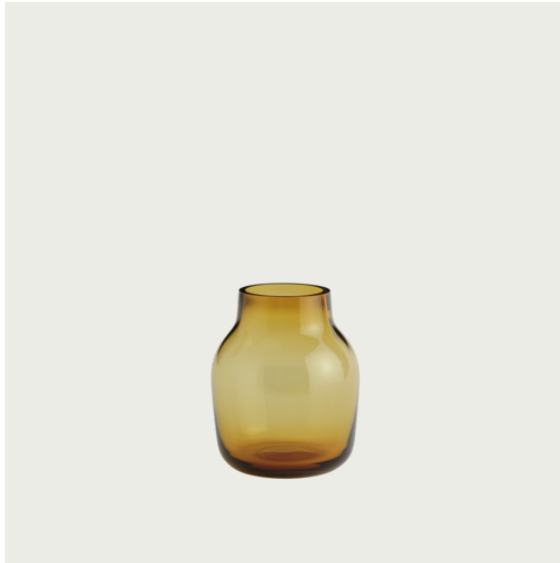

Shipper Colli 1  
 Gross Weight (kg) 1.6  
 Net Weight (kg) 1.5  
 Warranty Period 5 years

Pattern No.	Color	Contract Price	Lead Time
<b>Ready-To-Ship US Warehouse</b>			
MSILVS4-BORG	Burnt Orange	USD 58.00	-
MSILVS4-CLR	Clear	USD 58.00	-
MSILVS4-DKGN	Dark Green	USD 58.00	-

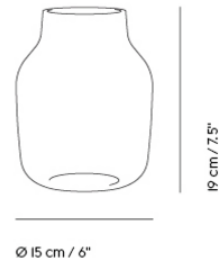

Shipper Colli	1
Gross Weight (kg)	1.85
Net Weight (kg)	1.7
Warranty Period	5 years

Pattern No.	Color	Contract Price	Lead Time
<b>Ready-To-Ship US Warehouse</b>			
MSILVS6-BORG	Burnt Orange	USD 89.00	-
MSILVS6-CLR	Clear	USD 89.00	-
MSILVS6-DKGN	Dark Green	USD 89.00	-

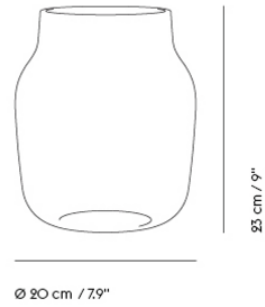

**Shipper Colli** 1  
**Gross Weight (kg)** 2.4  
**Net Weight (kg)** 2.2  
**Warranty Period** 5 years

Pattern No.	Color	Contract Price	Lead Time
<b>Ready-To-Ship US Warehouse</b>			
MSILVS8-BORG	Burnt Orange	USD 114.00	-
MSILVS8-CLR	Clear	USD 114.00	-
MSILVS8-DKGN	Dark Green	USD 114.00	-

# SKETCH TOOLBOX

FOR MORE INFORMATION,  
EXPLORE BELOW

- ↗ [Product Fact Sheet](#)
- ↗ [Images](#)
- ↗ [Architect Files](#)
- ↗ [Product Declaration](#)

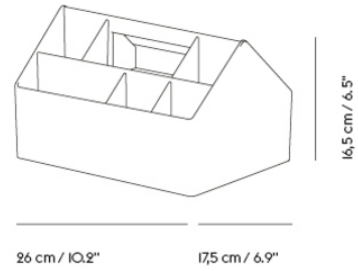

**Shipper Colli** 1  
**Gross Weight (kg)** 0.95  
**Net Weight (kg)** 0.8  
**Warranty Period** 5 years

Pattern No.	Color	Contract Price	Lead Time
<b>Ready-To-Ship US Warehouse</b>			
MSKTB-BORG	Burnt Orange	USD 68.00	-
MSKTB-GREY	Grey	USD 68.00	-
MSKTB-MBLU	Midnight Blue	USD 68.00	-

# STORY PINBOARD

FOR MORE INFORMATION,  
EXPLORE BELOW

- ↗ Product Fact Sheet
- ↗ Images
- ↗ Architect Files



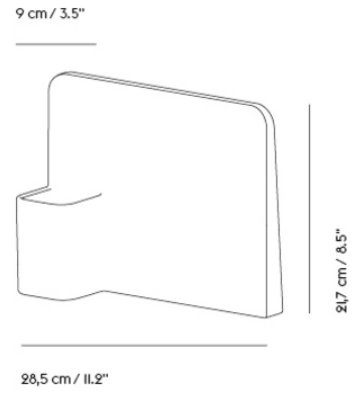

**Shipper Colli** 1  
**Gross Weight (kg)** 1.15  
**Net Weight (kg)** 0.452  
**Warranty Period** 5 years

Pattern No.	Color	Contract Price	Lead Time
<b>Ready-To-Ship US Warehouse</b>			
MSTPBD	Cork	USD 89.00	-

# TUB JUG

FOR MORE INFORMATION,  
EXPLORE BELOW

- ↗ [Product Fact Sheet](#)
- ↗ [Images](#)
- ↗ [Architect Files](#)
- ↗ [Product Declaration](#)

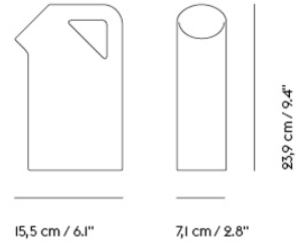

**Shipper Colli** | 1  
**Gross Weight (kg)** | 1.3  
**Net Weight (kg)** | 1  
**Warranty Period** | 5 years

Pattern No.	Color	Contract Price	Lead Time
<b>Ready-To-Ship US Warehouse</b>			
MTUBJG-DKGN	Dark Green	USD 131.00	-
MTUBJG-PBLU	Pale Blue	USD 131.00	-
MTUBJG-SAND	Sand ***	USD 131.00	-

# TWINE CUSHION

FOR MORE INFORMATION,  
EXPLORE BELOW

[↗ Product Fact Sheet](#)

[↗ Images](#)

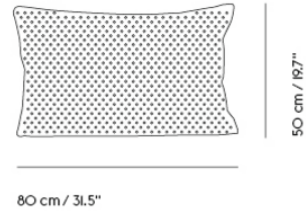

**Shipper Colli** 1  
**Gross Weight (kg)** 1.2  
**Net Weight (kg)** 0.65  
**Warranty Period** 5 years

Pattern No.	Color	Contract Price	Lead Time
<b>Ready-To-Ship EU Warehouse</b>			
MTWICUS2032-BEGY	Beige-Grey ***	USD 310.00	-

# VARJO RUG

FOR MORE INFORMATION,  
EXPLORE BELOW

- ↗ [Product Fact Sheet](#)
- ↗ [Images](#)
- ↗ [Architect Files](#)
- ↗ [Assembly Instructions](#)

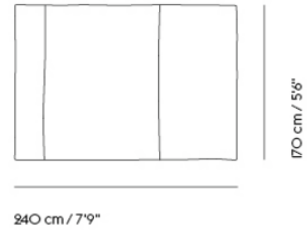

**Shipper Colli** 1  
**Gross Weight (kg)** 8.8  
**Net Weight (kg)** 7.8  
**Warranty Period** 5 years

Pattern No.	Color	Contract Price	Lead Time
<b>Ready-To-Ship US Warehouse</b>			
MVARRG6693-BLUE	Blue	USD 1,034.00	-
MVARRG6693-DKGN	Dark Green	USD 1,034.00	-
MVARRG6693-DKGY	Dark Grey	USD 1,034.00	-
MVARRG6693-YELW	Yellow	USD 1,034.00	-
<b>Extras</b>			
MPLYPA6681	Rug Pad - 160 x 230 cm / 5'2 x 7'5"	USD 89.00	-

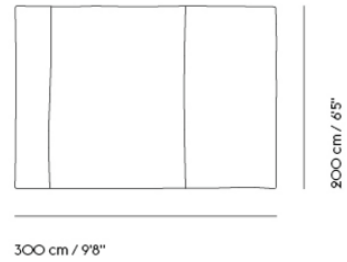

Shipper Colli 1  
 Gross Weight (kg) 14.7  
 Net Weight (kg) 12.8  
 Warranty Period 5 years

Pattern No.	Color	Contract Price	Lead Time
<b>Ready-To-Ship US Warehouse</b>			
MVARRG78116-BLUE	Blue	USD 1,675.00	-
MVARRG78116-DKGN	Dark Green	USD 1,675.00	-
MVARRG78116-DKGY	Dark Grey	USD 1,675.00	-
MVARRG78116-YELW	Yellow	USD 1,675.00	-
<b>Extras</b>			
MPLYPA78116	Rug Pad - 190 x 290 cm / 6'2 x 9'5"	USD 110.00	-



# WAVE TRAY

FOR MORE INFORMATION,  
EXPLORE BELOW

- ↗ [Product Fact Sheet](#)
- ↗ [Images](#)
- ↗ [Architect Files](#)
- ↗ [Product Declaration](#)

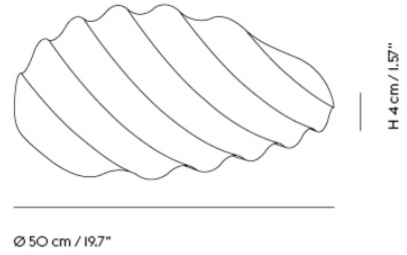

Shipper Colli 1  
 Gross Weight (kg) 2.8  
 Net Weight (kg) 2  
 Warranty Period 5 Years

Pattern No.	Color	Contract Price	Lead Time
<b>Ready-To-Ship US Warehouse</b>			
MWVTY	Steel	USD 278.00	-



## PRODUCT

70/70-Grey Frame/Oak (WL) 295x108 cm/116x42,5in  
 70/70-Grey Frame/Solid Oak 225x90 cm/85,5x35,5in  
 70/70-Grey Frame/Solid Oak 295x108 cm/116x42,5in  
 70/70-Grey Frame/Solid Oak 225x108cm/100,5x42,5in  
 70/70-Grey Frame/Solid Smoked Oak 225x90 cm  
 70/70-Grey Frame/Solid Smoked Oak 295x108 cm  
 70/70-Grey Frame/Solid Smoked Oak 225x108cm  
 70/70-Sand Frame/Black Lino 225x90 cm/85,5x35,5in  
  
 70/70-Sand Frame/Black Lino 225x108cm/100,5x42,5in  
 70/70-Sand Frame/Grey Lino 225x90 cm/85,5x35,5in  
  
 70/70-Sand Frame/Grey Lino 225x108cm/100,5x42,5in  
  
 70/70-Sand Frame/Oak (WL) 225x90 cm/85,5x35,5in  
 70/70-Sand Frame/Oak (WL) 295x108 cm/116x42,5in  
 70/70-Sand Frame/Solid Oak 225x90 cm/85,5x35,5in  
 70/70-Sand Frame/Solid Oak 295x108 cm/116x42,5in  
 70/70-Sand Frame/Solid Oak 225x108cm/100,5x42,5in  
 70/70-Sand Frame/Solid Smoked Oak 225x90 cm  
 70/70-Sand Frame/Solid Smoked Oak 295x108 cm  
 70/70-Sand Frame/Solid Smoked Oak 225x108cm  
 70/70-Sand Frame/White Lam 225x108cm/100,5x42,5in  
  
 70/70-White Frame/Black Lino 225x90 cm/85,5x35,5in  
 70/70-White Frame/Black Lino 225x108cm/100,5x42,5in  
 70/70-White Frame/Grey Lino 225x108cm/100,5x42,5in  
 70/70-White Frame/Oak (WL) 225x90 cm/85,5x35,5in  
 70/70-White Frame/Oak (WL) 295x108 cm/116x42,5in  
 70/70-White Frame/Solid Oak 225x90 cm/85,5x35,5in  
 70/70-White Frame/Solid Oak 295x108 cm/116x42,5in  
 70/70-White Frame/Solid Oak 225x108cm/100,5x42,5in  
 70/70-White Frame/Solid Smoked Oak 225x90 cm  
 70/70-White Frame/Solid Smoked Oak 295x108 cm  
 70/70-White Frame/Solid Smoked Oak 225x108cm  
 70/70-White Frame/White Lam 225x108cm/100,5x42,5in

Airy coffee table Nano - Half - Frame & top -Black  
 Airy coffee table Nano - Half - Frame & top -Grey  
 Airy coffee table Nano - Half - Frame & top -Plum  
 Airy coffee table Nano - Large - Frame & top -Grey  
 Airy coffee table Nano - Large - Frame & top -Plum  
 Airy coffee table Nano - Small - Frame & top -Grey  
 Airy coffee table Nano - Small - Frame & top -Plum  
 Airy coffee table Nano - Half-Frame & top-Off-white  
 Airy coffee table Nano -Large - Frame & top -Black  
 Airy coffee table Nano -Large-Frame&top -Off-white  
 Airy coffee table Nano- Medium - Frame & top -Grey  
 Airy coffee table Nano- Medium - Frame & top -Plum  
 Airy coffee table Nano -Medium-Frame&top-Off-white  
 Airy coffee table Nano - Small - Frame & top -Black  
 Airy coffee table Nano -Small-Frame&top-Off-white  
 Airy coffee table Nano-Medium - Frame & top -Black

Around - Extra Large - Antracit (WL)  
 Around - Extra Large - Grey (WL)  
 Around - Extra Large - White (WL)  
 Around - Large - Antracit (WL)  
 Around - Large - Black (WL)  
 Around - Large - Dusty Green (WL)  
 Around - Large - Grey (WL)  
 Around - Large - White (WL)  
 Around - Small - Antracit (WL)  
 Around - Small - Black (WL)  
 Around - Small - Dark Green (WL)  
 Around - Small - Dusty Green (WL)  
 Around - Small - Grey (WL)  
 Around - Small - Light Blue (WL)  
 Around - Small - Tan Rose (WL)  
 Around - Small - White (WL)  
 Base high table Black/Black Lino ply 190x85x105  
 Base high table Black/Black Lino ply 190x50x105  
 Base high table Black/Black Lino ply 190x50x95  
 Base high table Black/Black Lino ply 190x85x95  
 Base high table Black/Oak (WL) 190x50x105  
 Base high table Black/Oak (WL) 190x50x95  
 Base high table Black/Oak (WL) 190x85x105  
 Base high table Black/Oak (WL) 190x85x95  
 Base high table Black/White Lam ABS 190x50x105  
 Base high table Black/White Lam ABS 190x50x95  
 Base high table Black/White Lam ABS 190x85x105  
 Base high table Black/White Lam ABS 190x85x95  
 Base high table Black/White Lam ply 190x50x105  
 Base high table Black/White Lam ply 190x50x95  
 Base high table Black/White Lam ply 190x85x95  
 Base high table Black/White Lam ply 190x85x105  
 Base high table White/Black Lino ply 190x85x105  
 Base high table White/Black Lino ply 190x50x105  
 Base high table White/Black Lino ply 190x50x95  
 Base high table White/Black Lino ply 190x85x95

## COLOR CODES

TABLE TOP: Oak / FRAME: Grey (RAL 7030)  
 TABLE TOP: Oak / FRAME: Grey (RAL 7030)  
 TABLE TOP: Oak / FRAME: Grey (RAL 7030)  
 TABLE TOP: Oak / FRAME: Grey (RAL 7030)  
 TABLE TOP: Smoked Oak / FRAME: Grey (RAL 7030)  
 TABLE TOP: Smoked Oak / FRAME: Grey (RAL 7030)  
 TABLE TOP: Smoked Oak / FRAME: Grey (RAL 7030)  
 TABLE TOP: Black (Forbo 4023) / FRAME: Sand (NCS S 2010-Y3OR)  
 TABLE TOP: Black (forbo 4023 / FRAME: White (RAL 9016)  
 TABLE TOP: Grey (Forbo 4175) / FRAME: Sand (NCS S 2010-Y3OR)  
 TABLE TOP: Grey (Forbo 4175) / FRAME: Sand (NCS S 2010-Y3OR)  
 TABLE TOP: Oak FRAME: NCS S 2010-Y3OR  
 TABLE TOP: Oak FRAME: NCS S 2010-Y3OR  
 TABLE TOP: Oak FRAME: NCS S 2010-Y3OR  
 TABLE TOP: Oak FRAME: NCS S 2010-Y3OR  
 TABLE TOP: Smoked Oak FRAME: NCS S 2010-Y3OR  
 TABLE TOP: Smoked Oak FRAME: NCS S 2010-Y3OR  
 TABLE TOP: Smoked Oak FRAME: NCS S 2010-Y3OR  
 TABLE TOP: White (Fundermax OO85 FH) / FRAME: Sand (NCS S 2010-Y3OR)  
 TABLE TOP: Black (forbo 4023 / FRAME: White (RAL 9016)  
 TABLE TOP: Black (forbo 4023 / FRAME: White (RAL 9016)  
 TABLE TOP: Grey (Forbo 4175) / FRAME: White (RAL 9016)  
 TABLE TOP: Oak / FRAME: White (RAL 9016)  
 TABLE TOP: Oak / FRAME: White (RAL 9016)  
 TABLE TOP: Oak / FRAME: White (RAL 9016)  
 TABLE TOP: Oak / FRAME: White (RAL 9016)  
 TABLE TOP: Oak / FRAME: White (RAL 9016)  
 TABLE TOP: Oak / FRAME: White (RAL 9016)  
 TABLE TOP: Smoked Oak / FRAME: White (RAL 9016)  
 TABLE TOP: Smoked Oak / FRAME: White (RAL 9016)  
 TABLE TOP: Smoked Oak / FRAME: White (RAL 9016)  
 TABLE TOP: White (Fundermax OO85 SM) / FRAME: White (RAL 9016)  
 TOP: Black (FENIX NTM Nero Ingo 0720) / FRAME: RAL Classic 9011  
 TOP: Grey (FENIX NTM Beige Arizona 0748) / FRAME: RAL Classic 7039  
 TOP: Plum (FENIX NTM Rosso Jaipur 0751) / FRAME: NCS S 8010 - Y9OR  
 TOP: Grey (FENIX NTM Beige Arizona 0748) / FRAME: RAL Classic 7039  
 TOP: Plum (FENIX NTM Rosso Jaipur 0751) / FRAME: NCS S 8010 - Y9OR  
 TOP: Grey (FENIX NTM Beige Arizona 0748) / FRAME: RAL Classic 7039  
 TOP: Plum (FENIX NTM Rosso Jaipur 0751) / FRAME: NCS S 8010 - Y9OR  
 TOP: Off White (FENIX NTM Bianco Male 0029) / FRAME: RAL Classic 7044  
 TOP: Black (FENIX NTM Nero Ingo 0720) / FRAME: RAL Classic 9011  
 TOP: Off White (FENIX NTM Bianco Male 0029) / FRAME: RAL Classic 7044  
 TOP: Grey (FENIX NTM Beige Arizona 0748) / FRAME: RAL Classic 7039  
 TOP: Plum (FENIX NTM Rosso Jaipur 0751) / FRAME: NCS S 8010 - Y9OR  
 TOP: Off White (FENIX NTM Bianco Male 0029) / FRAME: RAL Classic 7044  
 TOP: Black (FENIX NTM Nero Ingo 0720) / FRAME: RAL Classic 9011  
 TOP: Off White (FENIX NTM Bianco Male 0029) / FRAME: RAL Classic 7044  
 TOP: Black (FENIX NTM Nero Ingo 0720) / FRAME: RAL Classic 9011  
 Antracit (NCS S 8005-R8OB)  
 Grey (Pantone Cool Grey 6 C)  
 White (RAL 9016)  
 Anthracite (NCS S 8005-R8OB)  
 Black (RAL 9005)  
 Dusty Green (NCS S 4010-G5OY)  
 Grey (Pantone Cool Grey 6 C)  
 White (RAL 9016)  
 Anthracite (NCS S 8005-R8OB)  
 Black (RAL 9005)  
 RAL 6012  
 Dusty Green (NCS S 4010-G5OY)  
 Grey (Pantone Cool Grey 6 C)  
 NCS 1515-B  
 NCS S 2030-Y8OR  
 White (RAL 9016)  
 Black (Forbo 4023 / Black (RAL 9005)  
 Black (Forbo 4023 / Black (RAL 9005)  
 Black (Forbo 4023 / Black (RAL 9005)  
 Black (Forbo 4023 / Black (RAL 9005)  
 RAL Classic 9005  
 RAL Classic 9005  
 RAL Classic 9005  
 RAL Classic 9005  
 RAL Classic 9005  
 White (Duropal HPL 410) / Black (RAL Classic 9005)  
 White (Duropal HPL 410) / Black (RAL Classic 9005)  
 White (Duropal HPL 410) / Black (RAL Classic 9005)  
 White (Duropal HPL 410) / Black (RAL Classic 9005)  
 White (Duropal HPL 410) / Black (RAL Classic 9005)  
 White (Duropal HPL 410) / Black (RAL Classic 9005)  
 White (Duropal HPL 410) / Black (RAL Classic 9005)  
 White (Duropal HPL 410) / Black (RAL Classic 9005)  
 White (Duropal HPL 410) / Black (RAL Classic 9005)  
 White (Duropal HPL 410) / Black (RAL Classic 9005)  
 Black (forbo 4023 / White (RAL 9016)  
 Black (forbo 4023 / White (RAL 9016)  
 Black (forbo 4023 / White (RAL 9016)  
 Black (forbo 4023 / White (RAL 9016)

## NEAREST MATCH

FRAME: NCS S 4502-Y, Pantone 415 C  
 FRAME: NCS S 4502-Y, Pantone 415 C  
 FRAME: NCS S 4502-Y, Pantone 415 C  
 FRAME: NCS S 4502-Y, Pantone 415 C  
 FRAME: NCS S 4502-Y, Pantone 415 C  
 FRAME: NCS S 4502-Y, Pantone 415 C  
 FRAME: NCS S 4502-Y, Pantone 415 C  
 -  
 -  
 -  
 -  
 -  
 FRAME: Pantone 2310 C  
 FRAME: Pantone 2310 C  
 FRAME: Pantone 2310 C  
 FRAME: Pantone 2310 C  
 FRAME: Pantone 2310 C  
 FRAME: Pantone 2310 C  
 FRAME: Pantone 2310 C  
 FRAME: Pantone 2310 C  
 -  
 TABLE TOP: NCS S 9000-N, FRAME: NCS S 0300-N  
 TABLE TOP: NCS S 9000-N, FRAME: NCS S 0300-N  
 TABLE TOP: NCS S 3502-Y, FRAME: NCS S 0300-N  
 FRAME: NCS S 0300-N  
 FRAME: NCS S 0300-N  
 FRAME: NCS S 0300-N  
 FRAME: NCS S 0300-N  
 FRAME: NCS S 0300-N  
 FRAME: NCS S 0300-N  
 FRAME: NCS S 0300-N  
 FRAME: NCS S 0300-N  
 TABLE TOP: NCS S 0502-G5OY, FRAME: NCS S 0300-N  
  
 TOP: RAL Classic 7021, Pantone 436 C, NCS S 8500-N/  
 FRAME: NCS S 9000-N, Pantone 426 C  
 TOP: Pantone Warm Grey 4C, NCS S 3005-Y5OR/ FRAME:  
 NCS S 6502-Y  
 TOP: Pantone 7630 C, NCS S 6020-Y9OR/ FRAME: RAL 8017  
  
 TOP: Pantone Warm Grey 4C, NCS S 3005-Y5OR/ FRAME:  
 NCS S 6502-Y  
 TOP: Pantone 7630 C, NCS S 6020-Y9OR/ FRAME: RAL 8017  
  
 TOP: Pantone Warm Grey 4C, NCS S 3005-Y5OR/ FRAME:  
 NCS S 6502-Y  
 TOP: Pantone 7630 C, NCS S 6020-Y9OR/ FRAME: RAL 8017  
  
 TOP: RAL 9010, NCS S 0500-N/ FRAME: NCS S 2502-Y,  
 Pantone 7535 C  
 TOP: RAL Classic 7021, Pantone 436 C, NCS S 8500-N/  
 FRAME: NCS S 9000-N, Pantone 426 C  
 TOP: RAL 9010, NCS S 0500-N/ FRAME: NCS S 2502-Y,  
 Pantone 7535 C  
 TOP: Pantone Warm Grey 4C, NCS S 3005-Y5OR/ FRAME:  
 NCS S 6502-Y  
 TOP: Pantone 7630 C, NCS S 6020-Y9OR/ FRAME: RAL 8017  
  
 TOP: RAL 9010, NCS S 0500-N/ FRAME: NCS S 2502-Y,  
 Pantone 7535 C  
 TOP: RAL Classic 7021, Pantone 436 C, NCS S 8500-N/  
 FRAME: NCS S 9000-N, Pantone 426 C  
 TOP: RAL 9010, NCS S 0500-N/ FRAME: NCS S 2502-Y,  
 Pantone 7535 C  
 TOP: RAL Classic 7021, Pantone 436 C, NCS S 8500-N/  
 FRAME: NCS S 9000-N, Pantone 426 C  
 RAL Design 260 20 O5, Pantone 432 C  
 NCS S 3502-B, RAL Design 000 70 OO  
 NCS S 0300-N, Pantone Cool Gray I C  
 RAL Design 260 20 O5, Pantone 432 C  
 NCS S 9000-N, Pantone Black C  
 RAL Design 120 60 IO, Pantone 5635 C  
 NCS S 3502-B, RAL Design 000 70 OO  
 NCS S 0300-N, Pantone Cool Gray I C  
 RAL Design 260 20 O5, Pantone 432 C  
 NCS S 9000-N, Pantone Black C  
 NCS S 8005-B8OG  
 RAL Design 120 60 IO, Pantone 5635 C  
 NCS S 3502-B, RAL Design 000 70 OO  
 Pantone 2204 C, RAL Design 240 80 IO  
 Pantone 7606 C, RAL Design 040 70 30  
 NCS S 0300-N, Pantone Cool Gray I C  
 TOP: NCS S 9000-N  
 TOP: NCS S 9000-N  
 TOP: NCS S 9000-N  
 TOP: NCS S 9000-N  
 -  
 -  
 -  
 -  
 -  
 TOP: NCS S 0502-Y  
 TOP: NCS S 0502-Y  
 TOP: NCS S 0502-Y  
 TOP: NCS S 0502-Y  
 TOP: NCS S 0502-Y  
 TOP: NCS S 0502-Y  
 TOP: NCS S 0502-Y  
 TOP: NCS S 0502-Y  
 TOP: NCS S 9000-N  
 TOP: NCS S 9000-N  
 TOP: NCS S 9000-N  
 TOP: NCS S 9000-N



**PRODUCT**

Doze Ottoman - Ocean ANTHR BLCK\_80  
 Doze Ottoman Swivel - Ocean BLCK\_80  
 Enfold Sideboard - Low - Oak/Black  
 Enfold Sideboard - Low - Oak/Dusty Green  
 Enfold Sideboard - Low - Oak/Grey  
 Enfold Sideboard - Tall - Oak/Dusty Green  
 Enfold Sideboard - Tall - Black/Black  
 Enfold Sideboard - Tall - Oak/Black  
 Enfold Sideboard - Tall - Oak/Grey  
 Enfold Sideboard Low 124x45x63cm Black/Black  
 Enfold Sideboard Low 124x45x63cm Oak/Deep Red  
 Enfold Sideboard Low Long 186x45x48cm Black/Black  
 Enfold Sideboard Low Long 186x45x48cm Oak/Black  
 Enfold Sideboard Low Long 186x45x48cm Oak/D.Green  
 Enfold Sideboard Low Long 186x45x48cm Oak/Deep Red  
 Enfold Sideboard Low Long 186x45x48cm Oak/Grey  
 Enfold Sideboard Tall IOOX45x85cm Oak/Deep Red  
 Enfold Sideboard Tall Wide 148x45x85cm Black/Black  
 Enfold Sideboard Tall Wide 148x45x85cm Oak/D.Green  
 Enfold Sideboard Tall Wide 148x45x85cm Oak/DeepRed  
 Enfold Sideboard Tall Wide 148x45x85cm Oak/Grey  
 Enfold Sideboard Tall Wide 148x45x85cm Oak/Black  
 Fiber ArmChair Tube FSC - Black/Black

Fiber ArmChair Tube FSC - DGRN/DGRN

Fiber ArmChair Tube FSC - Grey/Grey  
 Fiber ArmChair Tube FSC - Ochre/Black

Fiber ArmChair Tube FSC - White/White  
 Fiber ArmChair Wood BC FSC - Black/Black

Fiber ArmChair Wood BC FSC - DGRN/DGRN

Fiber ArmChair Wood BC FSC - Grey/Grey

Fiber ArmChair Wood BC FSC - Ochre/Oak  
 Fiber ArmChair Wood BC FSC - White/Oak  
 Fiber Bar Stool Tube H65 FSC - Black/Black

Fiber Bar Stool Tube H65 Grey/Grey-WHEN OOS 58904  
 Fiber Bar Stool Tube H65 White/White-OOS 58905  
 Fiber Bar Stool Tube H75 Black/Black-OOS 58906

Fiber Bar Stool Tube H75 Grey/Grey-WHEN OOS 58907  
 Fiber Bar Stool Tube H75 White/White-OOS 58908  
 Fiber Bar Stool w.Back Tube H65 FSC - Black/Black

Fiber Bar Stool w.Back Tube H65 FSC - White/White  
 Fiber Bar Stool w.Back Tube H65 Grey/Grey-OOS58918  
 Fiber Bar Stool w.Back Tube H75 FSC - Black/Black

Fiber Bar Stool w.Back Tube H75 FSC - Grey/Grey  
 Fiber Bar Stool w.Back Tube H75 FSC - OCHRE/BLACK

Fiber Bar Stool w.Back Tube H75 White/White-58922  
 Fiber Bar Stool w.Back Wood H65 FSC - Black/Black

Fiber Bar Stool w.Back Wood H65 FSC - Black/STDB  
 Fiber Bar Stool w.Back Wood H65 FSC - Grey/Grey  
 Fiber Bar Stool w.Back Wood H65 White/Oak-58925  
 Fiber Bar Stool w.Back Wood H75 Black/SDBrn  
 Fiber Bar Stool w.Back Wood H75 FSC - Black/Black

Fiber Bar Stool w.Back Wood H75 FSC - White/Oak  
 Fiber Bar Stool w.Back Wood H75 Grey/Grey-58927  
 Fiber Bar Stool Wood H65 Black/Black- OOS 58911

Fiber Bar Stool Wood H65 Grey/Grey-WHEN OOS 58912  
 Fiber Bar Stool Wood H65 White/Oak-WHEN OOS 58913  
 Fiber Bar Stool Wood H75 FSC - Black/Black

Fiber Bar Stool Wood H75 FSC - White/Oak  
 Fiber Bar Stool Wood H75 Grey/Grey-WHEN OOS 58915  
 Fiber Conf Arm Sw Gas Tilt Castor - Remix GREY\_I33  
 Fiber Conf Arm Swivel v2 - Refine - BLCK\_Cognac  
 Fiber ConfArm SwGas TiltCast v2 Refine-BLCK\_Cognac  
 Fiber Conference Arm Swivel v2 - Remix - GREY\_I33  
 Fiber Lounge Armchair Tube Ecriture GREY\_240  
 Fiber Lounge Armchair Tube Refine BLCK\_Cognac

Fiber Lounge Armchair Wood Refine BLCK\_Cognac

Fiber Lounge Tube Full Uph Divina BLACK\_I54  
 Fiber Lounge Tube Full Uph Remix GREY\_I33  
 Fiber Lounge Tube Full Uph St. Trio BLACK\_236  
 Fiber Lounge Wood Full Uph Remix GREY\_I33  
 Fiber Outdoor Armchair Anthracite Black  
 Fiber Outdoor Armchair Brown Red  
 Fiber Outdoor Armchair Dusty Green  
 Fiber Outdoor Armchair Grey  
 Fiber Outdoor Side Chair Anthracite Black  
 Fiber Outdoor Side Chair Brown Red  
 Fiber Outdoor Side Chair Dusty Green  
 Fiber Outdoor Side Chair Grey  
 Fiber Side A-Base FSC - Chrome/Grey  
 Fiber Side A-Base FSC - Chrome/White  
 Fiber Side Chair Tube FSC - Black/Black

Fiber Side Chair Tube FSC - DGRN/DGRN  
 Fiber Side Chair Tube FSC - Grey/Grey  
 Fiber Side Chair Tube FSC - Ochre/Black

Fiber Side Chair Tube FSC - White/White

**COLOR CODES**

Black (RAL 7021)  
 Black (RAL 7021)  
 RAL 7021  
 RAL 7033  
 RAL 7044  
 RAL 7033  
 RAL 7021  
 RAL 7021  
 RAL 7044  
 RAL 7021  
 RAL 7021  
 RAL 8015  
 RAL 7021  
 RAL 7021  
 RAL 7033  
 RAL 8015  
 RAL 7044  
 RAL 8015  
 RAL 7021  
 RAL 7033  
 RAL 8015  
 RAL 7044  
 RAL 8015  
 RAL 7021  
 RAL 7033  
 RAL 8015  
 RAL 7044  
 RAL 7021  
 SHELL: Black, BASE: Black (RAL 7021)

SHELL: Dusty Green, BASE: Dusty Green (RAL 7033)

SHELL: Grey, BASE: Grey RAL 7030)  
 SHELL: Ochre, BASE: Black (RAL 7021)

SHELL: White, BASE: White (RAL 9010)  
 BASE: RAL 7021

BASE: RAL 7033

BASE: RAL 7021

-

-

SHELL: Black, BASE: Black (RAL 7021)

SHELL: Grey, BASE: Grey RAL 7030)  
 SHELL: White, BASE: White (RAL 9010)  
 SHELL: Black, BASE: Black (RAL 7021)

SHELL: Grey, BASE: Grey RAL 7030)  
 SHELL: White, BASE: White (RAL 9010)  
 SHELL: Black, BASE: Black (RAL 7021)

SHELL: White, BASE: White (RAL 9010)  
 SHELL: Grey, BASE: Grey RAL 7030)  
 SHELL: Black, BASE: Black (RAL 7021)

SHELL: Grey, BASE: Grey RAL 7030)  
 SHELL: Ochre, BASE: Black (RAL 7021)

SHELL: White, BASE: White (RAL 9010)  
 SHELL: Black, BASE: Black (RAL 7021)

-

SHELL: Grey, BASE: Grey RAL 7030)

SHELL: White, BASE: Oak

-

SHELL: Black, BASE: Black (RAL 7021)

SHELL: White, BASE: Oak  
 SHELL: Grey, BASE: Grey RAL 7030)  
 SHELL: Black, BASE: Black (RAL 7021)

SHELL: Grey, BASE: Grey RAL 7030)  
 SHELL: White, BASE: Oak  
 SHELL: Black, BASE: Black (RAL 7021)

SHELL: White, BASE: Oak  
 SHELL: Grey, BASE: Grey RAL 7030)

RAL 7030

RAL 7021

RAL 7021

RAL 7030

SHELL: Ecriture 240, BASE: Grey (Ral 7030)

SHELL: Refine Leather Cognac, BASE: Anthracite Black (RAL

7021)

SHELL: Refine Leather Cognac, BASE: Anthracite Black (RAL

7021)

Divina I54 / Black (RAL 7021)

SHELL: Remix I33, BASE: Grey (Ral 7030)

Steelcut Trio 236 / Black (RAL 7021)

SHELL: Remix I33, BASE: Grey (Ral 7030)

RAL 7021

RAL 8017

RAL 7033

RAL 7044

RAL 7021

RAL 8017

RAL 7033

RAL 7044

SHELL: Grey/ BASE: Chrome

SHELL: White/ BASE: Chrome

SHELL: Black, BASE: Black (RAL 7021)

SHELL: Grey, BASE: Grey RAL 7030)

SHELL: Grey, BASE: Grey RAL 7030)

SHELL: Ochre, BASE: Black (RAL 7021)

SHELL: White, BASE: White (RAL 9010)

**NEAREST MATCH**

-  
 -  
 NCS S 8502-B, Pantone 426C  
 NCS S 5005-G50Y, Pantone 416C  
 NCS S 2502-Y, Pantone 413C  
 NCS S 5005-G50Y, Pantone 416C  
 NCS S 8502-B, Pantone 426C  
 NCS S 8502-B, Pantone 426C  
 NCS S 2502-Y, Pantone 413C  
 NCS S 8502-B, Pantone 426C  
 NCS S 6020-Y8OR  
 NCS S 8502-B, Pantone 426C  
 NCS S 8502-B, Pantone 426C  
 NCS S 5005-G50Y, Pantone 416C  
 NCS S 6020-Y8OR  
 NCS S 2502-Y, Pantone 413C  
 NCS S 6020-Y8OR  
 NCS S 8502-B, Pantone 426C  
 NCS S 5005-G50Y, Pantone 416C  
 NCS S 6020-Y8OR  
 NCS S 2502-Y, Pantone 413C  
 NCS S 8502-B, Pantone 426C  
 SHELL: RAL 7021, NCS S8500-N, BASE: NCS S 8500-N,  
 Pantone 426 C  
 SHELL: RAL 7033, NCS S 5005-G50Y, BASE: NCS S 5005-  
 G50Y, Pantone 416 C  
 SHELL: RAL 7030, NCS S 4502-Y, BASE: NCS S 4502-Y  
 SHELL: RAL IOII, NCS S 3040-Y2OR, BASE: NCS S 8500-N,  
 Pantone 426 C  
 SHELL: RAL 9010, NCS S 0502-Y, BASE: NCS S 0502-Y  
 SHELL: RAL 7021, NCS S 8500-N BASE: NCS S 8500-N,  
 Pantone 426 C  
 SHELL: RAL 7030, NCS S 5005-G50Y BASE: NCS S 5005-  
 G50Y, Pantone 416 C  
 SHELL: RAL 7021, NCS S 8500-N BASE: NCS S 8500-N,  
 Pantone 426 C  
 SHELL: RAL 9010, NCS S 3040-Y2OR  
 SHELL: RAL 9010, NCS S 0502-Y  
 SHELL: RAL 7021, NCS S8500-N, BASE: NCS S 8500-N,  
 Pantone 426 C  
 SHELL: RAL 7030, NCS S 4502-Y, BASE: NCS S 4502-Y  
 SHELL: RAL 9010, NCS S 0502-Y, BASE: NCS S 0502-Y  
 SHELL: RAL 7021, NCS S8500-N, BASE: NCS S 8500-N,  
 Pantone 426 C  
 SHELL: RAL 9010, NCS S 0502-Y, BASE: NCS S 0502-Y  
 SHELL: RAL 7030, NCS S 4502-Y, BASE: NCS S 4502-Y  
 SHELL: RAL 7021, NCS S8500-N, BASE: NCS S 8500-N,  
 Pantone 426 C  
 SHELL: RAL 7030, NCS S 4502-Y, BASE: NCS S 4502-Y  
 SHELL: RAL IOII, NCS S 3040-Y2OR, BASE: NCS S 8500-N,  
 Pantone 426 C  
 SHELL: RAL 9010, NCS S 0502-Y, BASE: NCS S 0502-Y  
 SHELL: RAL 7021, NCS S8500-N, BASE: NCS S 8500-N,  
 Pantone 426 C  
 SHELL: RAL 7021, NCS S 8500-N  
 SHELL: RAL 7030, NCS S 4502-Y, BASE: NCS S 4502-Y  
 SHELL: RAL 9010, NCS S 0502-Y  
 SHELL: RAL 7021, NCS S8500-N, BASE: NCS S 8500-N,  
 Pantone 426 C  
 SHELL: RAL 7030, NCS S 4502-Y, BASE: NCS S 4502-Y  
 SHELL: RAL 7021, NCS S8500-N, BASE: NCS S 8500-N,  
 Pantone 426 C  
 SHELL: RAL 7030, NCS S 4502-Y, BASE: NCS S 4502-Y  
 SHELL: RAL 9010, NCS S 0502-Y  
 SHELL: RAL 7021, NCS S8500-N, BASE: NCS S 8500-N,  
 Pantone 426 C  
 SHELL: RAL 7030, NCS S 4502-Y, BASE: NCS S 4502-Y  
 SHELL: RAL IOII, NCS S 3040-Y2OR, BASE: NCS S 8500-N,  
 Pantone 426 C  
 SHELL: RAL 9010, NCS S 0502-Y, BASE: NCS S 0502-Y

**PRODUCT**

Fiber Side Chair Wood BC FSC - Black/Black

Fiber Side Chair Wood BC FSC - DGRN/DGRN

Fiber Side Chair Wood BC FSC - Grey/Grey  
 Fiber Side Chair Wood BC FSC - Ochre/Oak  
 Fiber Side Chair Wood BC FSC - White/Oak  
 Fiber Soft Arm Swivel - Ecriture GREY\_240  
 Fiber Soft Arm Tube - Ecriture GREY\_240  
 Fiber Soft Arm Wood - Ecriture OAK\_240  
 Flow Trolley - 2-Layer - Blue-Grey  
 Flow Trolley - 2-Layer - Grey  
 Flow Trolley - 3-Layer - Blue-Grey  
 Flow Trolley - 3-Layer - Grey  
 Linear Steel Armchair - Black  
 Linear Steel Armchair - Burnt Orange  
 Linear Steel Armchair - Dark Green  
 Linear Steel Armchair - Grey  
 Linear Steel Armchair - Pale Blue  
 Linear Steel Armchair - White  
 Linear Steel Bar Stool (H75) - Black  
 Linear Steel Bar Stool (H75) - Burnt Orange  
 Linear Steel Bar Stool (H75) - Dark Green  
 Linear Steel Bar Stool (H75) - Grey  
 Linear Steel Bar Stool (H75) - Pale Blue  
 Linear Steel Bench Top/Legs Black 110cm V2  
 Linear Steel Bench Top/Legs Black 170cm V2  
 Linear Steel Bench Top/Legs Burnt Orange 110cm V2  
 Linear Steel Bench Top/Legs Burnt Orange 170cm V2  
 Linear Steel Bench Top/Legs Dark Green 110cm V2  
 Linear Steel Bench Top/Legs Dark Green 170cm V2  
 Linear Steel Bench Top/Legs Grey 110cm V2  
 Linear Steel Bench Top/Legs Grey 170cm V2  
 Linear Steel Bench Top/Legs Pale Blue 110cm V2  
 Linear Steel Bench Top/Legs Pale Blue 170cm V2  
 Linear Steel Bench Top/Legs White 110cm V2  
 Linear Steel Bench Top/Legs - White - 170cm  
 Linear Steel Cafe Table Black - H105 - 70x70cm  
 Linear Steel Cafe Table Black - H105 - 070cm  
 Linear Steel Cafe Table Black - H95 - 70x70cm  
 Linear Steel Cafe Table Black - H95 - 070cm  
 Linear Steel Cafe Table Burnt Orange H105 70x70cm  
 Linear Steel Cafe Table Burnt Orange H105 - 070cm  
 Linear Steel Cafe Table Burnt Orange H95 - 70x70cm  
 Linear Steel Cafe Table Burnt Orange H95 - 070cm  
 Linear Steel Cafe Table Dark Green - H105 - 070cm  
 Linear Steel Cafe Table Dark Green - H95 - 70x70cm  
 Linear Steel Cafe Table Dark Green - H95 - 070cm  
 Linear Steel Cafe Table Dark Green - H105 - 70x70cm  
 Linear Steel Cafe Table Grey - H105 - 70x70cm  
 Linear Steel Cafe Table Grey - H105 - 070cm  
 Linear Steel Cafe Table Grey - H95 - 70x70cm  
 Linear Steel Cafe Table Grey - H95 - 070cm  
 Linear Steel Cafe Table Pale Blue - H105 - 70x70cm  
 Linear Steel Cafe Table Pale Blue - H105 - 070cm  
 Linear Steel Cafe Table Pale Blue - H95 - 70x70cm  
 Linear Steel Cafe Table Pale Blue - H95 - 070cm  
 Linear Steel Cafe Table V2 B. Orange H73 - 70x70cm  
 Linear Steel Cafe Table V2 Black - H73 - 70x70cm  
 Linear Steel Cafe Table V2 Black - H73 - 070cm  
 Linear Steel Cafe Table V2 Burnt Orange H73 - 070cm  
 Linear Steel Cafe Table V2 Dark Green - H73 - 070cm  
 Linear Steel Cafe Table V2 Dark Green H73 - 70x70cm  
 Linear Steel Cafe Table V2 Grey - H73 - 70x70cm  
 Linear Steel Cafe Table V2 Grey - H73 - 070cm  
 Linear Steel Cafe Table V2 Pale Blue H73 - 70x70cm  
 Linear Steel Cafe Table V2 Pale Blue H73 - 070cm  
 Linear Steel Coffee Table 042 / H47 - Black  
 Linear Steel Coffee Table 042 / H47 - Burnt Orange  
 Linear Steel Coffee Table 042 / H47 - Dark Green  
 Linear Steel Coffee Table 042 / H47 - Grey  
 Linear Steel Coffee Table 042 / H47 - Pale Blue  
 Linear Steel Coffee Table 070 / H40 - Black  
 Linear Steel Coffee Table 070 / H40 - Burnt Orange  
 Linear Steel Coffee Table 070 / H40 - Dark Green  
 Linear Steel Coffee Table 070 / H40 - Grey  
 Linear Steel Coffee Table 070 / H40 - Pale Blue  
 Linear Steel Counter Stool (H65) - Black  
 Linear Steel Counter Stool (H65) - Burnt Orange  
 Linear Steel Counter Stool (H65) - Dark Green  
 Linear Steel Counter Stool (H65) - Grey  
 Linear Steel Counter Stool (H65) - Pale Blue  
 Linear Steel Lounge Chair - Pale Blue  
 Linear Steel Lounge Chair - Black  
 Linear Steel Lounge Chair - Burnt Orange  
 Linear Steel Lounge Chair - Dark Green  
 Linear Steel Lounge Chair - Grey  
 Linear Steel Side Chair - Black  
 Linear Steel Side Chair - Burnt Orange  
 Linear Steel Side Chair - Dark Green  
 Linear Steel Side Chair - Grey  
 Linear Steel Side Chair - Pale Blue  
 Linear Steel Side Chair - White  
 Linear Steel Table Top/Legs Black 140x75cm V2  
 Linear Steel Table Top/Legs Black 200x75cm V2  
 Linear Steel Table Top/Legs Black - 220x90cm V3  
 Linear Steel Table Top/Legs Burnt Orange 140x75cm V2  
 Linear Steel Table Top/Legs Burnt Orange 200x75cm V2  
 Linear Steel Table Top/Legs Burnt Orange 220x90cm V3  
 Linear Steel Table Top/Legs DrkGreen 140x75cm V2  
 Linear Steel Table Top/Legs DrkGreen 200x75cm V2  
 Linear Steel Table Top/Legs DrkGreen 220x90cm V3  
 Linear Steel Table Top/Legs Grey 140x75cm V2  
 Linear Steel Table Top/Legs Grey 200x75cm V2  
 Linear Steel Table Top/Legs Grey - 220x90cm V3

**COLOR CODES**

SHELL: Black, BASE: Black (RAL 7021)

SHELL: Green, BASE: Green (RAL 7033)

SHELL: Grey, BASE: Grey (RAL 7030)  
 SHELL: Ochre, BASE: Oak  
 SHELL: White, BASE: Oak  
 Base: RAL 7030  
 Base: RAL 7030  
 Base: RAL 7030  
 RAL 5008  
 RAL 7044  
 RAL 5008  
 RAL 7044  
 Black (RAL 7021)  
 Burnt Orange (RAL 8001)  
 Dark Green (RAL 6012)  
 Grey (RAL 7044)  
 Pale Blue (NCS 4020-B)  
 White (RAL 1013)  
 Black (RAL 7021)  
 Burnt Orange (RAL 8001)  
 Dark Green (RAL 6012)  
 Dark Green (RAL 6012)  
 Grey (RAL 7044)  
 Grey (RAL 7044)  
 Pale Blue (NCS 4020-B)  
 Black (RAL 7021)  
 Black (RAL 7021)  
 Burnt Orange (RAL 8001)  
 Burnt Orange (RAL 8001)  
 Burnt Orange (RAL 8001)  
 Dark Green (RAL 6012)  
 Dark Green (RAL 6012)  
 Grey (RAL 7044)  
 Grey (RAL 7044)  
 Pale Blue (NCS 4020-B)  
 White (RAL 1013)  
 Black (RAL 7021)  
 Black (RAL 7021)  
 Black (RAL 7021)  
 Burnt Orange (RAL 8001)  
 Burnt Orange (RAL 8001)  
 Burnt Orange (RAL 8001)  
 Burnt Orange (RAL 8001)  
 Dark Green (RAL 6012)  
 Dark Green (RAL 6012)  
 Dark Green (RAL 6012)  
 Grey (RAL 7044)  
 Grey (RAL 7044)  
 Grey (RAL 7044)  
 Pale Blue (NCS 4020-B)  
 Pale Blue (NCS 4020-B)  
 Pale Blue (NCS 4020-B)  
 Burnt Orange (RAL 8001)  
 Black (RAL 7021)  
 Black (RAL 7021)  
 Burnt Orange (RAL 8001)  
 Dark Green (RAL 6012)  
 Dark Green (RAL 6012)  
 Grey (RAL 7044)  
 Grey (RAL 7044)  
 Pale Blue (NCS 4020-B)  
 Pale Blue (NCS 4020-B)  
 Pale Blue (NCS 4020-B)  
 Burnt Orange (RAL 8001)  
 Black (RAL 7021)  
 Black (RAL 7021)  
 Burnt Orange (RAL 8001)  
 Dark Green (RAL 6012)  
 Dark Green (RAL 6012)  
 Grey (RAL 7044)  
 Grey (RAL 7044)  
 Pale Blue (NCS 4020-B)  
 RAL 7021  
 RAL 8001  
 RAL 6012  
 RAL 7044  
 NCS 4020-B  
 RAL 7021  
 RAL 8001  
 RAL 6012  
 RAL 7044  
 NCS 4020-B  
 Black (RAL 7021)  
 Burnt Orange (RAL 8001)  
 Dark Green (RAL 6012)  
 Grey (RAL 7044)  
 Pale Blue (NCS 4020-B)  
 NCS 4020-B  
 RAL 7021  
 RAL 8001  
 RAL 6012  
 RAL 7044  
 RAL 7021  
 RAL 8001  
 RAL 6012  
 Grey (RAL 7044)  
 Pale Blue (NCS 4020-B)  
 RAL 1013  
 Black (RAL 7021)  
 Black (RAL 7021)  
 Black (RAL 7021)  
 Burnt Orange (RAL 8001)  
 Burnt Orange (RAL 8001)  
 Burnt Orange (RAL 8001)  
 Dark Green (RAL 6012)  
 Dark Green (RAL 6012)  
 Dark Green (RAL 6012)  
 Grey (RAL 7044)  
 Grey (RAL 7044)  
 Grey (RAL 7044)

**NEAREST MATCH**

SHELL: RAL 7021, NCS 58500-N, BASE: NCS S 8500-N, Pantone 426 C  
 SHELL: RAL 7033, NCS S 5005-G50Y, BASE: NCS S 5005-G50Y, Pantone 416 C  
 SHELL: RAL 7030, NCS S 4502-Y, BASE: NCS S 4502-Y  
 SHELL: RAL 1011, NCS S 3040-Y8R  
 SHELL: RAL 9010, NCS S 0502-Y  
 Base: NCS S 4502-Y  
 Base: NCS S 4502-Y  
 Base: NCS S 4502-Y  
 -  
 -  
 -  
 -  
 -  
 NCS S 8002-B  
 -  
 -  
 NCS S 8005-B8OG, Pantone 447 C  
 NCS-S 2502-Y, Pantone 413 C  
 -  
 NCS S 1005-Y3OR  
 NCS S 8002-B  
 -  
 NCS S 8005-B8OG, Pantone 447 C  
 -  
 NCS S 8002-B  
 NCS S 8002-B  
 -  
 -  
 NCS S 8005-B8OG, Pantone 447 C  
 NCS S 8005-B8OG, Pantone 447 C  
 NCS-S 2502-Y, Pantone 413 C  
 NCS-S 2502-Y, Pantone 413 C  
 -  
 -  
 NCS S 1005-Y3OR  
 NCS S 1005-Y3OR  
 NCS S 8002-B  
 NCS S 8002-B  
 NCS S 8002-B  
 NCS S 8002-B  
 -  
 -  
 NCS S 8005-B8OG, Pantone 447 C  
 NCS S 8005-B8OG, Pantone 447 C  
 NCS S 8005-B8OG, Pantone 447 C  
 NCS S 8005-B8OG, Pantone 447 C  
 NCS-S 2502-Y, Pantone 413 C  
 NCS-S 2502-Y, Pantone 413 C  
 NCS-S 2502-Y, Pantone 413 C  
 NCS-S 2502-Y, Pantone 413 C  
 -  
 -  
 -  
 -  
 -  
 -  
 -  
 NCS S 8002-B  
 NCS S 8002-B  
 -  
 -  
 NCS S 8005-B8OG, Pantone 447 C  
 NCS S 8005-B8OG, Pantone 447 C  
 NCS-S 2502-Y, Pantone 413 C  
 NCS-S 2502-Y, Pantone 413 C  
 -  
 -  
 -  
 -  
 NCS S 8002-B  
 -  
 NCS S 8005-B8OG, Pantone 447 C  
 NCS-S 2502-Y, Pantone 413 C  
 -  
 -  
 -  
 -  
 NCS S 8002-B  
 -  
 NCS S 8005-B8OG, Pantone 447 C  
 NCS-S 2502-Y, Pantone 413 C  
 -  
 -  
 -  
 -  
 NCS S 8002-B  
 -  
 NCS S 8005-B8OG, Pantone 447 C  
 NCS-S 2502-Y, Pantone 413 C  
 -  
 -  
 -  
 -  
 NCS S 8002-B  
 -  
 NCS S 8005-B8OG, Pantone 447 C  
 NCS-S 2502-Y, Pantone 413 C  
 -  
 -  
 -  
 -  
 NCS S 1005-Y3OR  
 NCS S 8002-B  
 NCS S 8002-B  
 -  
 -  
 -  
 -  
 NCS S 8005-B8OG, Pantone 447 C  
 NCS S 8005-B8OG, Pantone 447 C  
 NCS-S 2502-Y, Pantone 413 C  
 NCS-S 2502-Y, Pantone 413 C  
 NCS-S 2502-Y, Pantone 413 C  
 NCS-S 2502-Y, Pantone 413 C

**PRODUCT**

Linear Steel Table Top/Legs Pale Blue 140x75cm V2  
 Linear Steel Table Top/Legs Pale Blue 200x75cm V2  
 Linear Steel Table Top/Legs Pale Blue 220x90cm V3  
 Linear Steel Table Top/Legs White 200x75cm V2  
 Linear Sys. E. Mod. - Lam. - White - 142x120  
 Linear Sys. E. Mod. - Lam. - White - 142x240  
 Linear Sys. E. Mod. - N. Lam. - BLCK -142x24  
 Linear Sys. E. Mod. - N. Lam. - BLCK -142x120  
 Linear Sys. M. Mod. - Lam - White - 142x240  
 Linear Sys. M. Mod. - Oak/B. N. Lam. -142x240  
 Linear Sys. T. - Con. 1 - Lam. - White - W142  
 Linear Sys. T. - Con. 1 - Oak/B. N. Lam. - W142  
 Linear Sys. T. - Con. 2 - Lam. - White - W142  
 Linear Sys. T. - Con. 2 - Oak/B. N. Lam. - W142  
 Linear Sys. T. - Lam. - White - 240cm - W142  
 Linear Sys. T. - Oak/B. N. Lam. - 240cm - W142  
 Loft Bar H65 - Black/Black

Loft Bar H65 - Black/Oak  
 Loft Bar H65 - Dusty Green/Oak  
 Loft Bar H65 - Oak/Deep Red  
 Loft Bar H65 - Oak/Grey  
 Loft Bar H75 - Black/Black

Loft Bar H75 - Black/Oak  
 Loft Bar H75 - Dusty Green/Oak  
 Loft Bar H75 - Oak/Deep Red  
 Loft Bar H75 - Oak/Grey  
 Loft Chair - Black/Black  
 Loft Chair - Black/Oak  
 Loft Chair - Dusty Green/Oak  
 Loft Chair - Oak/Deep Red  
 Loft Chair - Oak/Grey  
 Loft Chair - Stained Dark Brown/Black  
 Loft Chair - White/Oak  
 Loft Chair W. Arm - Black/Black  
 Loft Chair W. Arm - Black/Oak  
 Loft Chair W. Arm - Oak/Deep Red  
 Loft Chair W. Arm - Oak/Dusty Green  
 Loft Chair W. Arm - Oak/Grey  
 Loft Chair W. Arm - Stained Dark Brown/Black  
 Midst Table - Black/Black - Ø120cm/47.24in  
 Midst Table - Black/Black - Ø160cm/62.99"  
 Midst Table - D. Oiled Oak/Black - Ø120cm/47.24in  
 Midst Table - D. Oiled Oak/Black - Ø160cm/62.99"  
 Midst Table - D. Oiled Oak/D. Red - Ø120cm/47in  
 Midst Table - D. Oiled Oak/D. Red - Ø160cm/62.99"  
 Midst Table - D. Oiled Oak/Grey - Ø120cm/47.24in  
 Midst Table - D. Oiled Oak/Grey - Ø160cm/62.99"  
 Midst Table - D. Red/D. Red - Ø120cm/47.24in  
 Midst Table - D. Red/D. Red - Ø160cm/62.99"  
 Midst Table - Solid Oak/Black - Ø120cm/47.24in  
 Midst Table - Solid Oak/Black - Ø160cm/62.99"  
 Midst Table - Solid Oak/D. Red - Ø120cm/47.24in  
 Midst Table - Solid Oak/D. Red - Ø160cm/62.99"  
 Midst Table - Solid Oak/Grey - Ø120cm/47.24in  
 Midst Table - Solid Oak/Grey - Ø160cm/62.99"  
 Mini Stacked - Brown Green - Large  
 Mini Stacked - Brown Green - Medium  
 Mini Stacked - Brown Green - Small  
 Mini Stacked - Grey - Large - 2.0  
 Mini Stacked - Grey - Medium - 2.0  
 Mini Stacked - Grey - Small - 2.0  
 Mini Stacked - Midnight Blue - Large DISC W OOS  
 Mini Stacked - Midnight Blue - Small DISC WHEN OOS  
 Mini Stacked - White - Large - 2.0  
 Mini Stacked - White - Medium - 2.0  
 Mini Stacked - White - Small - 2.0  
 Mini Stacked Clip - Brown Green - 1pcs  
 Mini Stacked Clip - Grey - 1 pc - 2.0  
 Mini Stacked Clip - White - 1 pc - 2.0  
 Mini Stacked Clip set - Dusty Green 5 pcs - 2.0  
 Mini Stacked Clip Set - Grey - 5 pcs - 2.0  
 Mini Stacked Clip Set - Grey - 5 pcs -2.0-DISC.OOS  
 Mini Stacked Clip Set - MTBL - 5 pcs DISC WHEN OOS  
 Mini Stacked OakMedium -W/Light Grey back DISC W O  
 Nerd Bar - H65 - Midnight Blue (WL)  
 Nerd Bar - H65 - T. Rose w. Steel foot protect(WL)  
 Nerd Bar - H65 -Black (WL)  
 Nerd Bar - H65 -Black w. Steel foot protect (WL)  
 Nerd Bar - H65 -Green (WL)  
 Nerd Bar - H65 -Green w. Steel foot protect (WL)  
 Nerd Bar - H65 -Grey (WL)  
 Nerd Bar - H65 -Grey w. Steel foot protect (WL)  
 Nerd Bar - H65 -Tan Rose (WL)  
 Nerd Bar - H75 - Midnight Blue (WL)  
 Nerd Bar - H75 - Sand Yellow (WL)  
 Nerd Bar - H75 - T. Rose w. Steel foot protect(WL)  
 Nerd Bar - H75 - White (WL)  
 Nerd Bar - H75 -Black (WL)  
 Nerd Bar - H75 -Black w. Steel foot protect (WL)  
 Nerd Bar - H75 -Green (WL)  
 Nerd Bar - H75 -Green w. Steel foot protect (WL)  
 Nerd Bar - H75 -Grey (WL)  
 Nerd Bar - H75 -Grey w. Steel foot protect (WL)  
 Nerd Bar - H75 -Tan Rose (WL)  
 Nerd Bar-H65-Midnight Blue Steel foot protect (WL)  
 Nerd Bar-H65-Sand Yellow w. Steel foot protect(WL)  
 Nerd Bar-H75-Midnight Blue Steel foot protect (WL)  
 Nerd Bar-H75-Sand Yellow w. Steel foot protect(WL)  
 Nerd Chair - Black (WL)  
 Nerd Chair - Green (WL)  
 Nerd Chair - Grey (WL)  
 Nerd Chair - Midnight Blue (WL)  
 Nerd Chair - Sand Yellow (WL)

**COLOR CODES**

Pale Blue (NCS 4020-B)  
 Pale Blue (NCS 4020-B)  
 Pale Blue (NCS 4020-B)  
 Off-White (RAL 1013)  
 Formica FIO40 Alpino  
 Formica FIO40 Alpino  
 FENIX NTM 0720 Nero Ingo  
 FENIX NTM 0720 Nero Ingo  
 Formica FIO40 Alpino  
 FENIX NTM 0720 Nero Ingo  
 Formica FIO40 Alpino  
 FENIX NTM 0720 Nero Ingo  
 Formica FIO40 Alpino  
 FENIX NTM 0720 Nero Ingo  
 Formica FIO40 Alpino  
 FENIX NTM 0720 Nero Ingo  
 SEAT/BACK: Black (RAL 9005), FRAME: Black (RAL 9005)

SEAT/BACK: OAK, FRAME: Black (RAL 9005)  
 SEAT/BACK: Oak, FRAME: Dusty Green (RAL 7033)  
 SEAT/BACK: OAK, FRAME: Deep Red (RAL 8015)  
 SEAT/BACK: OAK, FRAME: Grey (RAL 7044)  
 SEAT/BACK: Black (RAL 9005), FRAME: Black (RAL 9005)

SEAT/BACK: OAK, FRAME: Black (RAL 9005)  
 SEAT/BACK: Oak, FRAME: Dusty Green (RAL 7033)  
 SEAT/BACK: OAK, FRAME: Deep Red (RAL 8015)  
 SEAT/BACK: OAK, FRAME: Grey (RAL 7044)  
 SEAT/BACK: Black (RAL 9005), FRAME: Black (RAL 9005)  
 SEAT/BACK: OAK, FRAME: Black (RAL 9005)  
 SEAT/BACK: Oak, FRAME: Dusty Green (RAL 7033)  
 SEAT/BACK: OAK, FRAME: Deep Red (RAL 8015)  
 SEAT/BACK: OAK, FRAME: Grey (RAL 7044)  
 SEAT/BACK: Stained Dark Brown, FRAME: Black (RAL 9005)  
 SEAT/BACK: OAK, FRAME: White (RAL 9016)  
 SEAT/BACK: Black (RAL 9005), FRAME: Black (RAL 9005)  
 SEAT/BACK: OAK, FRAME: Black (RAL 9005)  
 SEAT/BACK: OAK, FRAME: Deep Red (RAL 8015)  
 SEAT/BACK: Oak, FRAME: Dusty Green (RAL 7033)  
 SEAT/BACK: OAK, FRAME: Grey (RAL 7044)  
 SEAT/BACK: Stained Dark Brown, FRAME: Black (RAL 9005)  
 Forbo - Nero 4023/RAL 9005  
 Forbo - Nero 4023/RAL 9005  
 Dark Oiled Oak/RAL 9005  
 Dark Oiled Oak/RAL 9005  
 Dark Oiled Oak/RAL 8017  
 Dark Oiled Oak/RAL 8017  
 Dark Oiled Oak/RAL 7044  
 Dark Oiled Oak/RAL 7044  
 Forbo - Burgundy 4154/RAL 8017  
 Forbo - Burgundy 4154/RAL 8017  
 Oiled Oak/RAL 9005  
 Oiled Oak/RAL 9005  
 Oiled Oak/RAL 8017  
 Oiled Oak/RAL 8017  
 Oiled Oak/RAL 7044  
 Oiled Oak/RAL 7044  
 NCS S 6030-G90Y  
 NCS S 6030-G90Y  
 NCS S 6030-G90Y  
 Light Grey (NCS 2000-N)  
 Light Grey (NCS 2000-N)  
 Light Grey (NCS 2000-N)  
 Midnight Blue (NCS S 8010-R90B)  
 Midnight Blue (NCS S 8010-R90B)  
 RAL 9016  
 RAL 9016  
 RAL 9016  
 NCS S 6030-G90Y  
 NCS S 2000-N  
 RAL 9016  
 Dusty Green (Pantone 5625 C)  
 Light Grey (NCS S 2000-N)  
 Grey (NCS S 5502-B)  
 Midnight Blue (NCS S 8010-R90B)  
 Oak/Light Grey (NCS 2000-N)  
 Midnight Blue (RAL 5004)  
 Tan Rose (NCS 2030-Y80R)  
 Black (RAL 9017)  
 Black (RAL 9017)  
 Green (NCS S 6020-G)  
 Green (NCS S 6020-G)  
 Grey (RAL 7040)  
 Grey (RAL 7040)  
 Tan Rose (NCS 2030-Y80R)  
 Midnight Blue (RAL 5004)  
 Sand Yellow (RAL 1002)  
 Sand Yellow (RAL 1002)  
 Sand Yellow (RAL 1002)  
 Black (RAL 9017)  
 Green (NCS S 6020-G)  
 Grey (RAL 7040)  
 Grey (RAL 7040)  
 Tan Rose (NCS 2030-Y80R)  
 Midnight Blue (RAL 5004)  
 Sand Yellow (RAL 1002)  
 Sand Yellow (RAL 1002)  
 Sand Yellow (RAL 1002)  
 Green (NCS S 6020-G)  
 Grey (RAL 7040)  
 Midnight Blue (RAL 5004)  
 Sand Yellow (RAL 1002)

**NEAREST MATCH**

-  
 -  
 -  
 NCS S 1005-Y30R  
 RAL 9010  
 RAL 9010  
 NCS S 8500-N, RAL DESIGN/OOO 25 OO  
 NCS S 8500-N, RAL DESIGN/OOO 25 OO  
 RAL 9010  
 NCS S 8500-N, RAL DESIGN/OOO 25 OO  
 RAL 9010  
 NCS S 8500-N, RAL DESIGN/OOO 25 OO  
 RAL 9010  
 NCS S 8500-N, RAL DESIGN/OOO 25 OO  
 RAL 9010  
 NCS S 8500-N, RAL DESIGN/OOO 25 OO  
 BACK: NCS S 9000-N, Pantone 419C, FRAME: NCS S 9000-N, Pantone 419C  
 FRAME: NCS S 9000-N, Pantone 419C  
 FRAME: NCS S 5005-G50Y, Pantone 416 C  
 FRAME: NCS S 6020-Y80R  
 -  
 BACK: NCS S 9000-N, Pantone 419C, FRAME: NCS S 9000-N, Pantone 419C  
 FRAME: NCS S 9000-N, Pantone 419C  
 FRAME: NCS S 5005-G50Y, Pantone 416 C  
 FRAME: NCS S 6020-Y80R  
 -  
 BACK: NCS S 9000-N, Pantone 419C, FRAME: NCS S 9000-N, Pantone 419C  
 FRAME: NCS S 9000-N, Pantone 419C  
 FRAME: NCS S 5005-G50Y, Pantone 416 C  
 FRAME: NCS S 6020-Y80R  
 -  
 FRAME: NCS S 0300-N  
 FRAME: NCS S 9000-N, Pantone 419C  
 FRAME: NCS S 9000-N, Pantone 419C  
 FRAME: NCS S 6020-Y80R  
 -  
 FRAME: NCS S 0300-N  
 FRAME: NCS S 9000-N, Pantone 419C  
 FRAME: NCS S 9000-N, Pantone 419C  
 FRAME: NCS S 6020-Y80R  
 -  
 FRAME: NCS S 9000-N, Pantone 419C  
 Base Color: NCS S 9000-N, Pantone 419 C  
 Base Color: NCS S 9000-N, Pantone 419 C  
 Base Color: NCS S 9000-N, Pantone 419 C  
 Base Color: NCS S 9000-N, Pantone 419 C  
 Base Color: NCS S 8010-Y90R  
 Base Color: NCS S 8010-Y90R  
 Base Color: NCS S 2502-Y, Pantone 413 C  
 Base Color: NCS S 2502-Y, Pantone 413 C  
 Base Color: NCS S 8010-Y90R  
 Base Color: NCS S 8010-Y90R  
 Base Color: NCS S 9000-N, Pantone 419 C  
 Base Color: NCS S 9000-N, Pantone 419 C  
 Base Color: NCS S 8010-Y90R  
 Base Color: NCS S 8010-Y90R  
 Base Color: NCS S 2502-Y, Pantone 413 C  
 Base Color: NCS S 2502-Y, Pantone 413 C  
 -  
 -  
 -  
 RAL 7047, Pantone 420C  
 RAL 7047, Pantone 420C  
 RAL 7047, Pantone 420C  
 -  
 -  
 NCS S 0300-N  
 NCS S 0300-N  
 NCS S 0300-N  
 -  
 Pantone 420 C  
 -  
 NCS S5010-G10Y, RAL Design 150 50 10  
 RAL 7047, Pantone 420C  
 -  
 -  
 NCS S 3502-B, RAL Design 000 70 00  
 NCS S 8505-R80B, Pantone 532 C  
 Pantone 7606 C, RAL Design 040 70 30  
 RAL Design 000 20 00  
 RAL Design 000 20 00  
 RAL Design 170 40 15  
 RAL Design 170 40 15  
 NCS 4005-R80B, Pantone Cool Grey 7C  
 NCS 4005-R80B, Pantone Cool Grey 7C  
 Pantone 7606 C, RAL Design 040 70 30  
 NCS S 8505-R80B, Pantone 532 C  
 NCS S 2030-Y10R, Pantone 7508 C  
 Pantone 7606 C, RAL Design 040 70 30  
 NCS S 0502-G50Y, RAL Design 110 96 02  
 RAL Design 000 20 00  
 RAL Design 000 20 00  
 RAL Design 170 40 15  
 RAL Design 170 40 15  
 NCS 4005-R80B, Pantone Cool Grey 7C  
 NCS 4005-R80B, Pantone Cool Grey 7C  
 Pantone 7606 C, RAL Design 040 70 30  
 NCS S 8505-R80B, Pantone 532 C  
 NCS S 2030-Y10R, Pantone 7508 C  
 Pantone 426 C, RAL Design 000 20 00  
 RAL Design 170 40 15  
 NCS S 4005-R80B, Pantone Cool Grey 7C  
 NCS S 8505-R80B, Pantone 532 C  
 NCS S 2030-Y10R, Pantone 7508 C



**PRODUCT**

Nerd Chair - Tan Rose (WL)  
 Nerd Chair - White (WL)  
 OOS ORDER I5780 Stacked Clip set White 5 pcs. 2.0  
 Oslo - 3 Seater - RAL 7026/Steelcut I80  
 Oslo - 5-Trio - 3 Seater - Dark Grey\_966  
 Oslo - Vidar - 2 Seater - Navy Blue\_554  
 Oslo - Vidar - 3 Seater - Navy Blue\_554  
 Oslo Lounge Chair Swivel Twill Weave BLCK\_990  
 Oslo Lounge Chair Swivel Vidar GREY\_I46  
 Oslo Lounge Chair Tube Twill Weave BLCK\_990  
 Oslo Lounge Chair Tube Vidar GREY\_I46  
 Outline - Refine - 3-seater - Cognac - 250  
 Outline - Refine Leather - 2-seater - Cognac O250  
 Outline - Refine Leather - Chair - Cognac  
 Outline - Remix - 2-seater - I63  
 Outline - Remix - 3-seater - I63  
 Outline - Remix - Chair - I63  
 Reflect - Sideboard L I05 CM - Black  
 Reflect - Sideboard L I80 CM - Black  
 Relate Side Table High - Black  
 Relate Side Table High - Blue-Grey

Relate Side Table High - Dark Green - Top and Base

Relate Side Table High - Oak Laminate / Black  
 Relate Side Table High - Off-White  
 Relate Side Table High - SLD Oak - Off-White BS  
 Relate Side Table High - SLD SMK Oak - Black Base  
 Relate Side Table High - C. Oak Ven/whit OOS I3988  
 Relate Side Table Low - Black  
 Relate Side Table Low - Blue-Grey

Relate Side Table Low - Dark Green Top

Relate Side Table Low - Off-White  
 Relate Side Table Low - Solid Oak - Off-white  
 Relate Side Table Low - Solid Smoked Oak - Black  
 Relate Side Table Low - C. Oak Ven/Black OOS I3989  
 Relate Side Table Low - C. Oak Ven/whit OOS I3990  
 Soft Cafe Table - B. Green/B. Green 70x70cm

Soft Cafe Table - B. Green/B. Green 075

Soft Cafe Table - Black/Black - 70x70cm

Soft Cafe Table - Black/Black - 075

Soft Cafe Table - Black/Solid S. Oak - 70x70cm  
 Soft Cafe Table - Black/Solid Smoked Oak - 075  
 Soft Cafe Table - Grey/Grey - 075  
 Soft Cafe Table - Grey/Grey - 70x70cm  
 Soft Cafe Table - Grey/Solid Oak - 70x70cm  
 Soft Cafe Table - Grey/Solid Oak - 075  
 Soft Cafe Table HI05 - B. Green/B. Green 70x70cm

Soft Cafe Table HI05 - B. Green/B. Green 075

Soft Cafe Table HI05 - Black/Black - 70x70cm

Soft Cafe Table HI05 - Black/Black - 075

Soft Cafe Table HI05 - Black/Solid S. Oak 70x70cm  
 Soft Cafe Table HI05 - Black/Solid Smoked Oak 075  
 Soft Cafe Table HI05 - Grey/Grey - 075  
 Soft Cafe Table HI05 - Grey/Grey - 70x70cm  
 Soft Cafe Table HI05 - Grey/Solid Oak 70x70cm  
 Soft Cafe Table HI05 - Grey/Solid Oak 075  
 Soft Cafe Table H95 - B. Green/B. Green 70x70cm

Soft Cafe Table H95 - B. Green/B. Green 075

Soft Cafe Table H95 - Black/Black - 70x70cm

Soft Cafe Table H95 - Black/Black - 075

Soft Cafe Table H95 - Black/Solid S. Oak 70x70cm  
 Soft Cafe Table H95 - Black/Solid Smoked Oak 075  
 Soft Cafe Table H95 - Grey/Grey - 075  
 Soft Cafe Table H95 - Grey/Grey - 70x70cm  
 Soft Cafe Table H95 - Grey/Solid Oak - 075  
 Soft Cafe Table H95 - Grey/Solid Oak 70x70cm  
 Soft Coffee Table B. green/B. green 70x70cm

Soft Coffee Table B. green/B. green 075

Soft Coffee Table B. green/B. green 095

Soft Coffee Table Black/Black 70x70cm

Soft Coffee Table Black/Black 095

Soft Coffee Table Black/Solid D. O. Oak 70x70cm  
 Soft Coffee Table Black/Solid D. Oiled Oak 075  
 Soft Coffee Table Black/Solid D. Oiled Oak 095  
 Soft Coffee Table Grey/Grey 075  
 Soft Coffee Table Grey/Grey 095  
 Soft Coffee Table Grey/Grey 70x70cm  
 Soft Coffee Table Grey/Solid Oak 70x70cm  
 Soft Coffee Table Grey/Solid Oak 075  
 Soft Coffee Table Grey/Solid Oak 095  
 Soft Coffee Table - Black/Black 075

Soft Side Table H40 - B. Green/B. Green - Ø41cm

**COLOR CODES**

Tan Rose (NCS 2030-Y8OR)  
 White (RAL 9016)  
 RAL 9016  
 SEAT: Steelcut I80 / BASE: Dark Grey (RAL 7026)  
 SEAT: Steelcut Trio 966 / BASE: Dark Grey (RAL 7026)  
 SEAT: Vidar 554 / BASE: Navy Blue (RAL 5004)  
 SEAT: Vidar 554 / BASE: Navy Blue (RAL 5004)  
 RAL 9017  
 RAL 7044  
 RAL 9017  
 RAL 7044  
 SEAT: Cognac silk leather / BASE: Black (RAL 9005)  
 SEAT: Cognac silk leather / BASE: Black (RAL 9005)  
 SEAT: Cognac silk leather / BASE: Black (RAL 9005)  
 SEAT: Remix I63 / BASE: Black (RAL 9005)  
 SEAT: Remix I63 / BASE: Black (RAL 9005)  
 SEAT: Remix I63 / BASE: Black (RAL 9005)  
 RAL 9005  
 RAL 9005  
 TABLE TOP: Forbo Desktop 4023 Nero BASE: RAL 9011  
 TABLE TOP: Forbo Desktop 4179 Smokey Blue BASE: RAL 5008  
 TABLE TOP: Forbo Desktop 4174 Conifer BASE: RAL 6012  
 TABLE TOP: Oak Veneer BASE: Ral 9011  
 TABLE TOP: Forbo Desktop 4176 Mushroom BASE: RAL IOI3  
 TABLE TOP: Oiled Oak BASE: Ral IOI3  
 TABLE TOP: Oiled Oak BASE: Ral 9011  
 TABLE TOP: Oak Veneer BASE: Ral IOI3  
 TABLE TOP: Forbo Desktop 4023 Nero BASE: RAL 9011  
 TABLE TOP: Forbo Desktop 4179 Smokey Blue BASE: RAL 5008  
 TABLE TOP: Forbo Desktop 4174 Conifer BASE: RAL 6012  
 TABLE TOP: Forbo Desktop 4176 Mushroom BASE: RAL IOI3  
 TABLE TOP: Oiled Oak BASE: Ral IOI3  
 TABLE TOP: Oiled Oak BASE: Ral 9011  
 TABLE TOP: Oak Veneer BASE: Ral 9011  
 TABLE TOP: Oak Veneer BASE: Ral IOI3  
 TABLE TOP: Formica Laminate FO800 Artichoke BASE: NCS S 2020-G80Y  
 TABLE TOP: Formica Laminate FO800 Artichoke BASE: NCS S 2020-G80Y  
 TABLE TOP: Nanolaminate O720 BASE: RAL 9005  
 TABLE TOP: Nanolaminate O720 BASE: RAL 9005  
 TABLE TOP: Smoked Oak BASE: RAL 9005  
 TABLE TOP: Smoked Oak BASE: RAL 9005  
 TABLE TOP: Forbo Linoleum 4175 Pebble BASE: RAL 7044  
 TABLE TOP: Forbo Linoleum 4175 Pebble BASE: RAL 7044  
 TABLE TOP: Oiled Oak BASE: RAL 7044  
 TABLE TOP: Oiled Oak BASE: RAL 7044  
 TABLE TOP: Formica Laminate FO800 Artichoke BASE: NCS S 2020-G80Y  
 TABLE TOP: Formica Laminate FO800 Artichoke BASE: NCS S 2020-G80Y  
 TABLE TOP: Nanolaminate O720 BASE: RAL 9005  
 TABLE TOP: Nanolaminate O720 BASE: RAL 9005  
 TABLE TOP: Smoked Oak BASE: RAL 9005  
 TABLE TOP: Smoked Oak BASE: RAL 9005  
 TABLE TOP: Forbo Linoleum 4175 Pebble BASE: RAL 7044  
 TABLE TOP: Forbo Linoleum 4175 Pebble BASE: RAL 7044  
 TABLE TOP: Oiled Oak BASE: RAL 7044  
 TABLE TOP: Oiled Oak BASE: RAL 7044  
 TABLE TOP: Formica Laminate FO800 Artichoke BASE: NCS S 2020-G80Y  
 TABLE TOP: Formica Laminate FO800 Artichoke BASE: NCS S 2020-G80Y  
 TABLE TOP: Nanolaminate O720 BASE: RAL 9005  
 TABLE TOP: Nanolaminate O720 BASE: RAL 9005  
 TABLE TOP: Smoked Oak BASE: RAL 9005  
 TABLE TOP: Smoked Oak BASE: RAL 9005  
 TABLE TOP: Forbo Linoleum 4175 Pebble BASE: RAL 7044  
 TABLE TOP: Forbo Linoleum 4175 Pebble BASE: RAL 7044  
 TABLE TOP: Oiled Oak BASE: RAL 7044  
 TABLE TOP: Oiled Oak BASE: RAL 7044  
 TABLE TOP: Formica Laminate FO800 Artichoke BASE: NCS S 2020-G80Y  
 TABLE TOP: Formica Laminate FO800 Artichoke BASE: NCS S 2020-G80Y  
 TABLE TOP: Nanolaminate O720 BASE: RAL 9005  
 TABLE TOP: Nanolaminate O720 BASE: RAL 9005  
 TABLE TOP: Smoked Oak BASE: RAL 9005  
 TABLE TOP: Smoked Oak BASE: RAL 9005  
 TABLE TOP: Forbo Linoleum 4175 Pebble BASE: RAL 7044  
 TABLE TOP: Forbo Linoleum 4175 Pebble BASE: RAL 7044  
 TABLE TOP: Oiled Oak BASE: RAL 7044  
 TABLE TOP: Oiled Oak BASE: RAL 7044  
 TABLE TOP: Formica Laminate FO800 Artichoke BASE: NCS S 2020-G80Y  
 TABLE TOP: Formica Laminate FO800 Artichoke BASE: NCS S 2020-G80Y  
 TABLE TOP: Nanolaminate O720 BASE: RAL 9005  
 TABLE TOP: Nanolaminate O720 BASE: RAL 9005

**NEAREST MATCH**

Pantone 7606 C, RAL Design O40 70 30  
 NCS S 0502-G50Y, RAL Design I10 96 02  
 NCS S 0300-N  
 BASE: NCS S 8005-B20G, Pantone 446 C  
 BASE: NCS S 8005-B20G, Pantone 446 C  
 BASE: NCS S 8505-R80B, Pantone Black 6 C  
 BASE: NCS S 8505-R80B, Pantone Black 6 C  
 -  
 -  
 -  
 -  
 BASE: NCS S 9000-N, Pantone Black C  
 BASE: NCS S 9000-N, Pantone Black C  
 BASE: NCS S 9000-N, Pantone Black C  
 BASE: NCS S 9000-N, Pantone Black C  
 BASE: NCS S 9000-N, Pantone Black C  
 BASE: NCS S 9000-N, Pantone Black C  
 -  
 -  
 BASE: RAL Design OOO 20 00, Pantine 426 C  
 TABLE TOP: NCS S7010-R90B  
 TABLE TOP: NCS S 8005-G20Y BASE: NCS S 8005-B80G, Pantone 447 C  
 BASE: RAL Design OOO 20 00, Pantine 426 C  
 BASE: NCS S 1005-Y30R  
 BASE: NCS S 1005-Y30R  
 BASE: RAL Design OOO 20 00, Pantine 426 C  
 BASE: NCS S 1005-Y30R  
 BASE: RAL Design OOO 20 00, Pantine 426 C  
 TABLE TOP: NCS S 2020-G80Y BASE: Pantone 5855 C  
 TABLE TOP: NCS S 2020-G80Y BASE: Pantone 5855 C  
 TABLE TOP: NCS S 9000-N BASE: NCS 9000-N, Pantone 419 C  
 TABLE TOP: NCS S 9000-N BASE: NCS 9000-N, Pantone 419 C  
 BASE: NCS 9000-N, Pantone 419 C  
 BASE: NCS 9000-N, Pantone 419 C  
 TABLE TOP: NCS S 3502-Y BASE: NCS S 2502-Y, Pantone 413 C  
 TABLE TOP: NCS S 3502-Y BASE: NCS S 2502-Y, Pantone 413 C  
 BASE: NCS S 2502-Y, Pantone 413 C  
 BASE: NCS S 2502-Y, Pantone 413 C  
 TABLE TOP: NCS S 2020-G80Y BASE: Pantone 5855 C  
 TABLE TOP: NCS S 2020-G80Y BASE: Pantone 5855 C  
 TABLE TOP: NCS S 9000-N BASE: NCS 9000-N, Pantone 419 C  
 TABLE TOP: NCS S 9000-N BASE: NCS 9000-N, Pantone 419 C  
 BASE: NCS 9000-N, Pantone 419 C  
 BASE: NCS 9000-N, Pantone 419 C  
 TABLE TOP: NCS S 3502-Y BASE: NCS S 2502-Y, Pantone 413 C  
 TABLE TOP: NCS S 3502-Y BASE: NCS S 2502-Y, Pantone 413 C  
 BASE: NCS S 2502-Y, Pantone 413 C  
 BASE: NCS S 2502-Y, Pantone 413 C  
 TABLE TOP: NCS S 2020-G80Y BASE: Pantone 5855 C  
 TABLE TOP: NCS S 2020-G80Y BASE: Pantone 5855 C  
 TABLE TOP: NCS S 9000-N BASE: NCS 9000-N, Pantone 419 C  
 TABLE TOP: NCS S 9000-N BASE: NCS 9000-N, Pantone 419 C  
 BASE: NCS 9000-N, Pantone 419 C  
 BASE: NCS 9000-N, Pantone 419 C  
 TABLE TOP: NCS S 3502-Y BASE: NCS S 2502-Y, Pantone 413 C  
 TABLE TOP: NCS S 3502-Y BASE: NCS S 2502-Y, Pantone 413 C  
 BASE: NCS S 2502-Y, Pantone 413 C  
 BASE: NCS S 2502-Y, Pantone 413 C  
 TABLE TOP: NCS S 2020-G80Y BASE: Pantone 5855 C  
 TABLE TOP: NCS S 2020-G80Y BASE: Pantone 5855 C  
 TABLE TOP: NCS S 9000-N BASE: NCS 9000-N, Pantone 419 C  
 TABLE TOP: NCS S 9000-N BASE: NCS 9000-N, Pantone 419 C  
 BASE: NCS 9000-N, Pantone 419 C  
 BASE: NCS 9000-N, Pantone 419 C  
 TABLE TOP: NCS S 3502-Y BASE: NCS S 2502-Y, Pantone 413 C  
 TABLE TOP: NCS S 3502-Y BASE: NCS S 2502-Y, Pantone 413 C  
 BASE: NCS S 2502-Y, Pantone 413 C  
 BASE: NCS S 2502-Y, Pantone 413 C  
 TABLE TOP: NCS S 2020-G80Y BASE: Pantone 5855 C  
 TABLE TOP: NCS S 2020-G80Y BASE: Pantone 5855 C  
 TABLE TOP: NCS S 9000-N BASE: NCS 9000-N, Pantone 419 C  
 TABLE TOP: NCS S 9000-N BASE: NCS 9000-N, Pantone 419 C  
 BASE: NCS 9000-N, Pantone 419 C  
 BASE: NCS 9000-N, Pantone 419 C  
 TABLE TOP: NCS S 3502-Y BASE: NCS S 2502-Y, Pantone 413 C  
 TABLE TOP: NCS S 3502-Y BASE: NCS S 2502-Y, Pantone 413 C  
 BASE: NCS S 2502-Y, Pantone 413 C  
 BASE: NCS S 2502-Y, Pantone 413 C  
 TABLE TOP: NCS S 2020-G80Y BASE: Pantone 5855 C  
 TABLE TOP: NCS S 2020-G80Y BASE: Pantone 5855 C







**PRODUCT**

Ambit Pendant Ø40 - White - US

Ambit Pendant Ø55 - Black - US

Ambit Pendant Ø55 - Dusty Green - US

Ambit Pendant Ø55 - Grey - US

Ambit Pendant Ø55 - Light Blue - US

Ambit Pendant Ø55 - Taupe - US

Ambit Pendant Ø55 - White - US

Ambit Rail - Black - US

Ambit Rail - Grey - US

Ambit Rail - Taupe - US

Ambit Rail - White - US

Ambit Wall Lamp L37 / 14.5" - Taupe - US

Ambit Wall Lamp L37 / 14.5" - Black - US

Ambit Wall Lamp L37 / 14.5" - Grey - US

Ambit Wall Lamp L37 / 14.5" - White - US

Control Lamp - Black - LED - US

Control Lamp - Grey - LED - US

Control Lamp - Red - LED - US

Control Lamp - White - LED - US

Dedicate Table Lamp L2 - Black

Dedicate Table Lamp L2 - Brown Green

Dedicate Table Lamp L2 w. Clamp - Black

Dedicate Table Lamp L2 w. Clamp - Brown Green

Dedicate Table Lamp L2 w. Pin - Black

Dedicate Table Lamp L2 w. Pin - Brown Green

Dedicate Table Lamp S1 - Black

Dedicate Table Lamp S1 - Brown Green

Dedicate Table Lamp S1 w. Clamp - Black

Dedicate Table Lamp S1 w. Clamp - Brown Green

Dedicate Table Lamp S1 w. Pin - Black

Dedicate Table Lamp S1 w. Pin - Brown Green

Dedicate Table Lamp S2 - Black

Dedicate Table Lamp S2 - Brown Green

Dedicate Table Lamp S2 w. Clamp - Black

Dedicate Table Lamp S2 w. Clamp - Brown Green

Dedicate Table Lamp S2 w. Pin - Black

Dedicate Table Lamp S2 w. Pin - Brown Green

Dedicate Wall Lamp L2 - Black

Dedicate Wall Lamp L2 - Brown Green

Dedicate Wall Lamp S1 - Black

Dedicate Wall Lamp S1 - Brown Green

Dedicate Wall Lamp S2 - Black

Dedicate Wall Lamp S2 - Brown Green

E27 - Beige-Rose - US - LED

E27 - Black - US - LED

E27 - Clay brown - US - LED - NO SALE

E27 - Dark Green - US - LED

E27 - Dark Grey - US - LED

E27 - Deep Red - US - LED

E27 - Dusty Lilac - US - LED

E27 - Light Blue - US - LED

E27 - Light Grey - US - LED

E27 - Light Orange - US - LED

E27 - Midnight Blue - US - LED

E27 - Mustard - US - LED

E27 - Olive - US - LED

E27 - Orange - US - LED - NO SALE - USE 28315

E27 - Pale blue - US - LED

E27 - Rose - US - LED

E27 - Terracotta - US - LED - DISC WHEN OOS

E27 - White - US - LED

E27 - Yellow - US - LED - DISC WHEN OOS

Grain Pendant - Black - US

Grain Pendant - Blue Grey - US

Grain Pendant - Dark Green - US \*\*\*

Grain Pendant - Dusty Green - US

Grain Pendant - Grey - US

Grain Pendant - Nature - US

Grain Pendant - White - US

Leaf Lamp - Large - Black - US

Leaf Lamp - Large - Copper Brown - US

Leaf Lamp - Large - Dark Green - US

Leaf Lamp - Large - Grey - US

Leaf Lamp - Large - White - US

Leaf Lamp - Small - Black - US

Leaf Lamp - Small - Copper Brown - US

Leaf Lamp - Small - Dark Green - US

Leaf Lamp - Small - Grey - US

Leaf Lamp - Small - White - US

Linear - Mounted Lamp - 82.4" - Black - US

Linear - Mounted Lamp - 82.4" - Grey - US

Linear - Mounted Lamp - 91" - Black - US

Linear - Mounted Lamp - 91" - Grey - US

Linear - Pendant Lamp - 34.3" - Black - US

Linear - Pendant Lamp - 34.3" - Grey - US

Linear - Pendant Lamp - 66.6" - Black - US

Linear - Pendant Lamp - 66.6" - Grey - US

Linear - Table Lamp - Black - US

**COLOR CODES**

EXTERIOR: White (RAL 9016), INTERIOR: White (RAL 9016)

EXTERIOR: Black (RAL 7021), INTERIOR: White (RAL 9016)

EXTERIOR: Dusty Green (RAL 140 60 IO), INTERIOR: White (RAL 9016)

EXTERIOR: Grey (RAL 7040), INTERIOR: White (RAL 9016)

EXTERIOR: Light Blue (NCS 1515-R8OB), INTERIOR (RAL 9016)

EXTERIOR: Taupe (NCS 5 6005-Y5OR), INTERIOR: White (RAL 9016)

EXTERIOR: White (RAL 9016), INTERIOR: White (RAL 9016)

EXTERIOR: Black (RAL 7021), INTERIOR: White (RAL 9016)

EXTERIOR: Grey (RAL 7040), INTERIOR: White (RAL 9016)

EXTERIOR: Taupe (NCS 5 6005-Y5OR), INTERIOR: White (RAL 9016)

EXTERIOR: White (RAL 9016), INTERIOR: White (RAL 9016)

EXTERIOR: Taupe (NCS 5 6005-Y5OR), INTERIOR: White (RAL 9016)

EXTERIOR: Black (RAL 7021), INTERIOR: White (RAL 9016)

EXTERIOR: Grey (RAL 7040), INTERIOR: White (RAL 9016)

EXTERIOR: White (RAL 9016), INTERIOR: White (RAL 9016)

Black

Grey (Pantone 7534 C)

Red (Pantone 7619 C)

White (RAL 9016)

RAL 9011

NCS S 6030-G9OY

RAL 9011

NCS S 6030-G9OY

RAL 9011

NCS S 6030-G9OY

RAL 9011

NCS S 6030-G9OY

RAL 9011

NCS S 6030-G9OY

RAL 9011

NCS S 6030-G9OY

RAL 9011

NCS S 6030-G9OY

RAL 9011

NCS S 6030-G9OY

RAL 9011

NCS S 6030-G9OY

RAL 9011

NCS S 6030-G9OY

RAL 9011

NCS S 6030-G9OY

RAL 9011

NCS S 6030-G9OY

RAL 9011

NCS S 6030-G9OY

RAL 9011

NCS S 6030-G9OY

RAL 9011

RAL 8015

RAL 4009

NCS S 1515-R8OB

-

RAL 2000

RAL 5011

-

-

-

-

-

-

-

-

Pantone Black 6 C

NCS S 6010-R9OB

RAL 6012

Pantone 5555 C

RAL Classic 7004, NCS S 4000-N, Pantone cool gry 7 C

Pantone 7575 C

RAL 9016

RAL 9011

Copper Brown (RAL 8004)

Dark Green (RAL 6012)

RAL 7040

RAL 9016

Black (RAL 9011)

Copper Brown (RAL 8004)

Dark Green (RAL 6012)

RAL 7040

White (RAL 9016)

RAL 9011

RAL 7044

RAL 9011

RAL 7044

RAL 9011

RAL 7044

RAL 9011

RAL 7044

RAL 9011

**NEAREST MATCH**

EXTERIOR: Pantone 426 C, NCS 8505-R8OB, INTERIOR: NCS S 0300-N

EXTERIOR: Pantone 426 C, NCS 8505-R8OB, INTERIOR: NCS S 0300-N

EXTERIOR: Pantone 5635 C, NCS S 4010-G1OY, INTERIOR: NCS S 0300-N

EXTERIOR: Pantone Cool Grey 7C, NCS 4005-R8OB, INTERIOR: NCS S 0300-N

EXTERIOR: Pantone 537 C, RAL Design 260 80 IO, INTERIOR: NCS S 0300-N

EXTERIOR: Pantone Warm grey 10, RAL Classic 7006

EXTERIOR: Pantone 426 C, NCS 8505-R8OB, INTERIOR: NCS S 0300-N

EXTERIOR: Pantone 426 C, NCS 8505-R8OB, INTERIOR: NCS S 0300-N

EXTERIOR: Pantone Cool Grey 7C, NCS 4005-R8OB, INTERIOR: NCS S 0300-N

EXTERIOR: Pantone Warm grey 10, RAL Classic 7006

EXTERIOR: Pantone 426 C, NCS 8505-R8OB, INTERIOR: NCS S 0300-N

EXTERIOR: Taupe (NCS S 6005-Y5OR), INTERIOR: White (RAL 9016)

EXTERIOR: Pantone 426 C, NCS 8505-R8OB, INTERIOR: NCS S 0300-N

EXTERIOR: Pantone Cool Grey 7C, NCS 4005-R8OB, INTERIOR: NCS S 0300-N

EXTERIOR: White (RAL 9016), INTERIOR: White (RAL 9016)

(close to RAL 7021)

RAL Design 090 80 IO, NCS S 1505-G9OY

RAL Design 040 50 60

NCS S 0300-N

-

-

-

-

-

-

-

-

-

-

-

-

-

-

-

-

-

-

-

-

-

-

-

Pantone 7590 C, RAL Design 060 80 20, NCS 2010 Y-5OR

Pantone 426 C, RAL Design 000 15 00, NCS S 9000-N

Pantone 7572 C, RAL Classic 8001, NCS S 3050-Y3OR, RAL

Design 060 50 50

Pantone 5535 U

Pantone Cool Grey II U, RAL Classic 7037, NCS S 5005-R80 B

Pantone 1815 U

Pantone 5215 U

Pantone 651 U

Pantone Cool Grey 4 C, RAL Design 000 75 00, NCS S

2500-N

Pantone 130 U

Pantone 289 U

Pantone 1945 C, RAL 1005, NCS S 2060-Y1OR

RAL 7002, Pantone 7497 C, NCS S 5010-G9OY

Pantone 1655 C, RAL Classic 2004, NCS S 0585-Y7OR

Pantone 2137 C, NCS S 4030-R8OB, RAL Design 260 50 25

Pantone 692 C, RAL Design 010 80 15, NCS S 1020-R1OB

Pantone 7607C, NCS S 3040-Y8OR

RAL 9016, NCS S 0300-N

Pantone Yellow C, RAL Design 090 80 90, NCS S 0575-

G9OY

RAL Design 000 70 00, NCS S 3502-B, Pantone Black 6 C

-

-

RAL Design 160 50 15, NCS S 5020-B9OG, Pantone 5555 C

-

RAL Design 070 40 30, NCS 6030-Y2OR, Pantone 7575 C

-

NCS S 9000-N, Pantone 426 C

Pantone 1685 C, NCS S 5040-Y6OR

-

NCS S 4005-R8OB, Pantone Cool Grey 7C

NCS S 0300-N

NCS S 9000-N, Pantone 426 C

Pantone 1685 C, NCS S 5040-Y6OR

-

NCS S 4005-R8OB, Pantone Cool Grey 7C

NCS S 0300-N

-

-

-

-

-

-

-

-

-

-

-

-

-

-

-

-

-

-

-





# TEXTILE OPTIONS

Striving to work with the best suppliers, the textiles used for Muuto products are by Danish Kvadrat, American KnollTextiles, Swedish Nevotex along with Italian Arve and German Rohleder—all suppliers that have been selected on the basis of their extensive knowledge within the field and state-of-the-art material qualities.

\*Upholstered Muuto products that have the Declare Living Building Challenge Compliant certification only have the certification when upholstered with the following Kvadrat textiles: Canvas, Clara, Coda, Divina, Divina MD, Divina Mélange, Fiord, Hallingdal, Remix, Steelcut, Steelcut Trio, Umami and Vidar.



## ACCA BY KVADRAT

Designer: Sahco Upholstery.

Composition: 35% viscose, 33% recycled cotton, 25% recycled polyester, 7% recycled polyacrylic.

Durability: 50.000 Martindale / Lightfastness 5-6 (ISO I-8).

Sustainability: Recycled content. Complies with Greenguard Gold Certification.



101

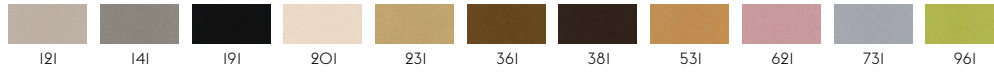

## AEGEAN BY KNOLLTEXTILES

Designer: KnollTextiles

Composition: 35% Acrylic, 15% Cotton, 10% Polyester, 40% Viscose

Durability: 60.000 Wyzenbeek Published / Lightfastness 5 (40hrs)

Sustainability: Clean Air - Silver



1

5 colors available for the Outline Series, Connect Modular Series, Echo Pouf and Fiber Series

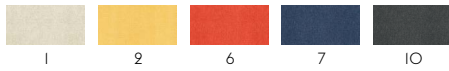

Additional colors available for Fiber Series

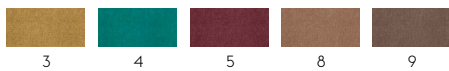

## BALDER BY KVADRAT

Designer: Fanny Aronsen

Composition: 68% new wool, 26% cotton, 6% nylon

Durability: 100.000 Martindale / Lightfastness 6

Sustainability: Natural fibres / Sustainable resource. Complies with Greenguard Gold Certification.



132

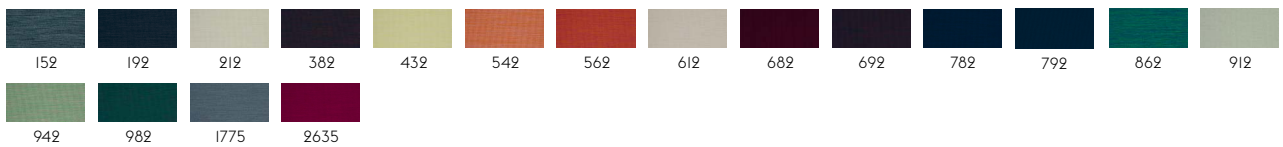

## BECK BY MAHARAM

Composition: 78% wool, 22% nylon.

Durability: 100.000 Martindale / Lightfastness AATCC I6.3, 40+ hours.

Sustainability: Complies with Greenguard Gold Certification.

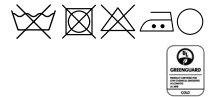

1

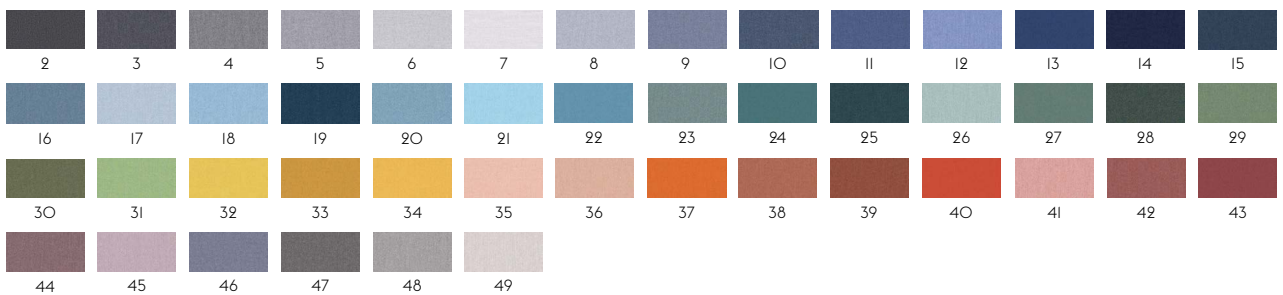





**CAMEO BY KNOLLTEXTILES**

Designer: KnollTextiles  
 Composition: 75% Cotton, 25% Viscose.  
 Durability: 30.000 Wyzenbeek Published / Lightfastness 4 (40hrs)  
 Sustainability: Greenguard Certification / Clean Air - Silver



**CANVAS BY KVADRAT**

Designer: Giulio Ridolfo.  
 Composition: 90% new wool worsted, 10% nylon.  
 Durability: 100.000 Martindale / Lightfastness 5-7 (ISO 1-8).  
 Sustainability: Complies with both EU ecolabel "The Flower" and Greenguard Gold Certification.

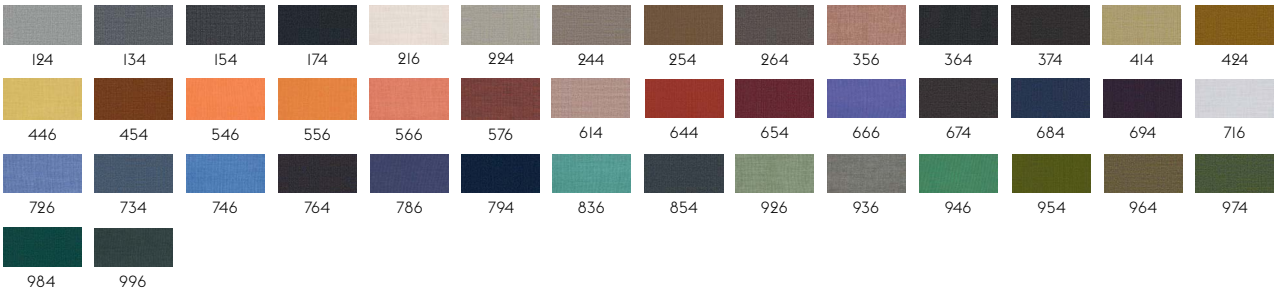
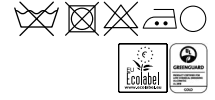

**CHAMELEON BY KNOLLTEXTILES**

Designer: KnollTextiles  
 Composition: 95% Polyurethane, 5% Silicone.  
 Durability: 250.000 Wyzenbeek Published  
 Sustainability: Clean Air - Gold  
 Bleach Cleanable

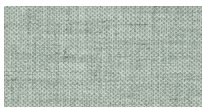
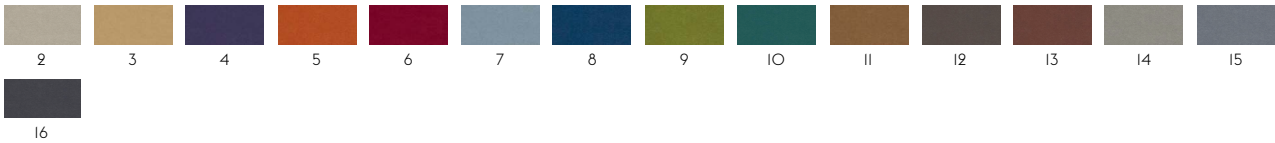

**CLARA BY KVADRAT**

Designer: Anne Birgitte Hansen.  
 Composition: 92% new wool worsted.  
 Durability: 80.000 Martindale.  
 Sustainability: Complies with both EU ecolabel "The Flower" and Greenguard Gold Certification.

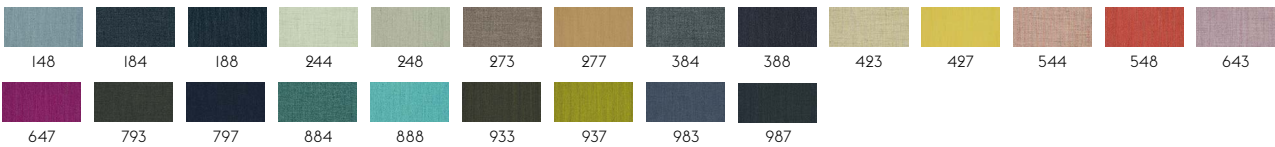
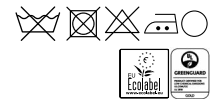

**CLAY BY KVADRAT**

Designer: Vincent Van Duysen for Kvadrat.  
 Composition: 76% Linen, 21% Cotton, 3% Polyester.  
 Durability: 45.000 Martindale / Lightfastness 4-6.  
 Sustainability: Complies with Greenguard Certification.

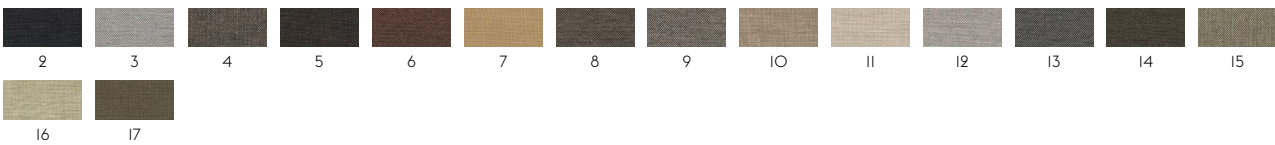



**COLOR FIELD BY KNOLLTEXTILES**

Designer: KnollTextiles  
 Composition: 100% Polyurethane.  
 Durability: 250.000 Wyzenbeek Published  
 Sustainability: Greenguard Certification / Clean Air - Silver  
 Bleach Cleanable



**DIVINA BY KVADRAT**

Designer: Finn Sködt.  
 Composition: 100% new wool.  
 Durability: 45.000 Martindale.  
 Sustainability: Complies with both EU ecolabel "The Flower" and Greenguard Gold Certification.

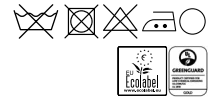

106

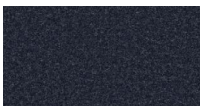
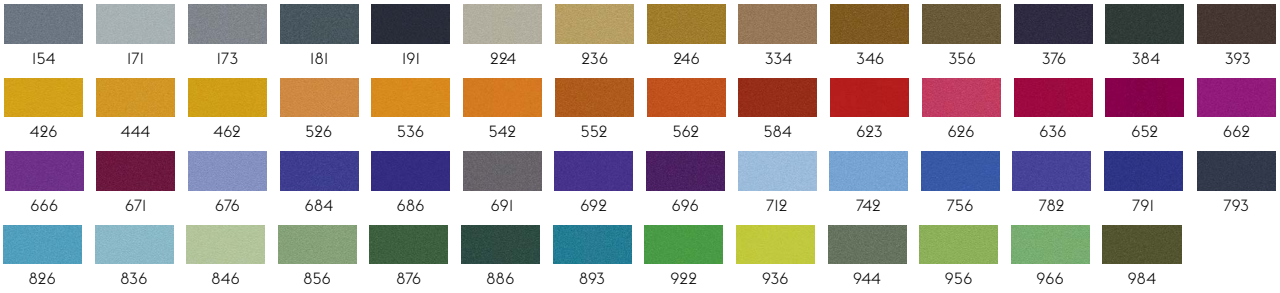

**DIVINA MD BY KVADRAT**

Designer: Finn Sködt.  
 Composition: 100% new wool.  
 Durability: 45.000 Martindale.  
 Sustainability: Complies with both EU ecolabel "The Flower" and Greenguard Gold Certification.

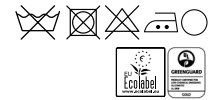

193

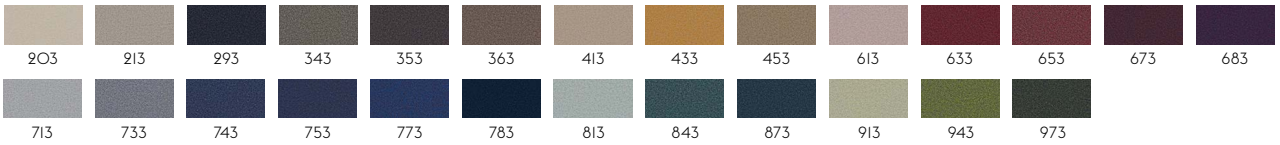

**DIVINA MELANGE BY KVADRAT**

Designer: Finn Sködt.  
 Composition: 100% new wool.  
 Durability: 45.000 Martindale / Lightfastness 6-7.  
 Sustainability: Complies with both EU ecolabel "The Flower" and Greenguard Gold Certification.

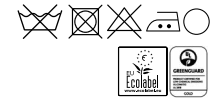

120

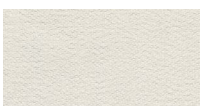
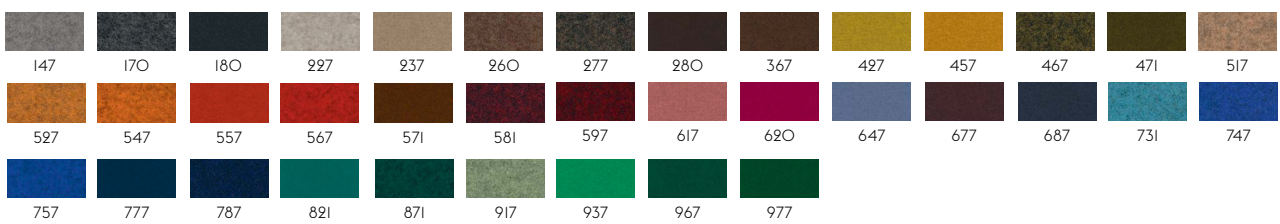

**ECRITURE BY KVADRAT**

Designer: Sahco.  
 Composition: 40% polyacrylic, 27% polyester, 18% viscose, 9% linen, 6% cotton.  
 Durability: 70.000 Martindale / Lightfastness 6.  
 Sustainability: Complies with Greenguard Gold Certification.

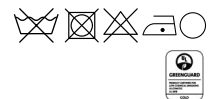

100



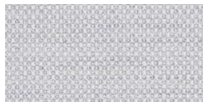

**FIORD BY KVADRAT**

Designer: Tone Barnung & Louise Sigvardt  
 Composition: 92% new wool worsted, 8% nylon.  
 Durability: 60.000 Martindale / Lightfastness 5-6.



101

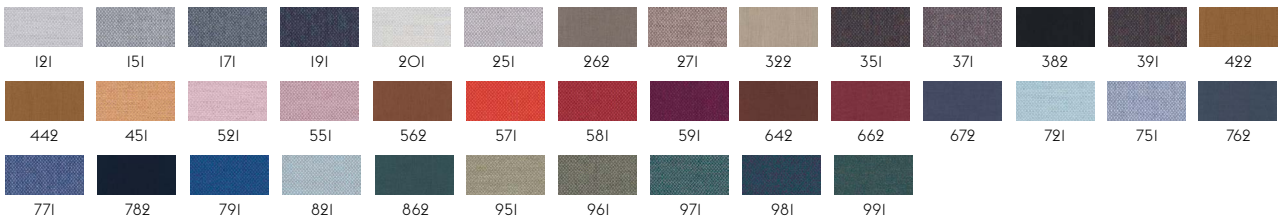

**GRAIN BY GABRIEL**

Composition: 80% Post-Consumer Recycled Polyester, 20% Polyester  
 Durability: 100.000 Martindale / AATCC 16 Light fastness.  
 Sustainability: 100% recyclable polyester and meet Möbelfakta requirements



60300

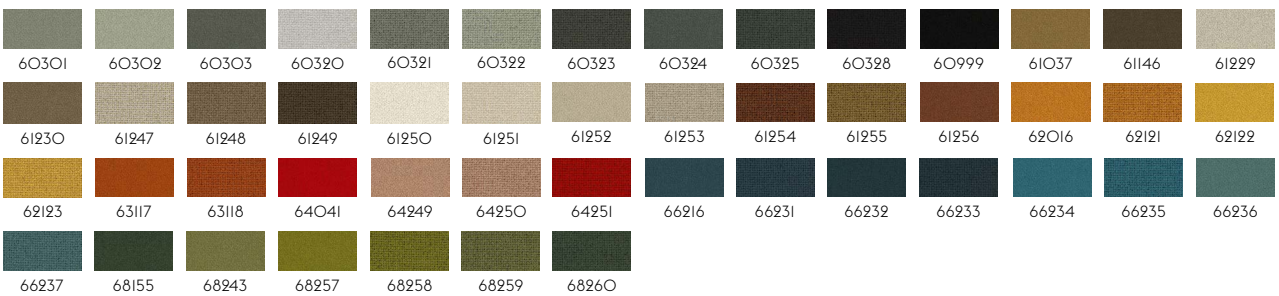

**HALLINGDAL 65 BY KVADRAT**

Designer: Nanna Ditzel  
 Composition: 70% new wool, 30% viscose.  
 Durability: 100.000 Martindale / Lightfastness 6-7.  
 Sustainability: Complies with both EU ecolabel "The Flower" and Greenguard Gold Certification.



100

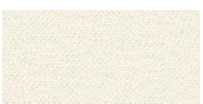
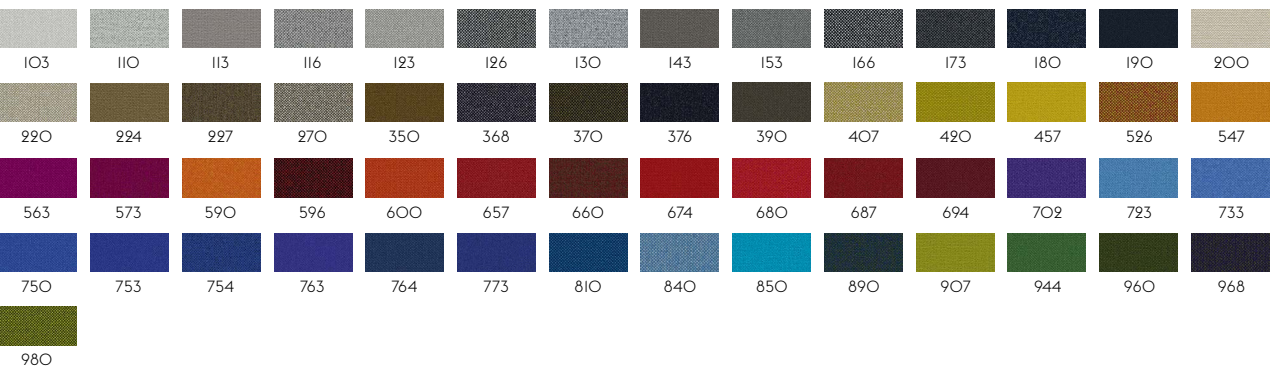

**HEARTH BY MAHARAM**

Composition: 32% wool, 31% acrylic, 30% cotton, 7% polyester  
 Durability: 60.000 Martindale / Lightfastness AATCC 16.3, 40+ hours.  
 Sustainability: Complies with Greenguard Gold Certification.



1



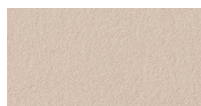

**HIGHLAND BY KNOLLTEXTILES**

Designer: KnollTextiles  
 Composition: 100% Wool  
 Durability: 40.000 Martindale 2 / Lightfastness 4 (40hrs 2)  
 Sustainability: Greenguard Certification / Clean Air - Silver

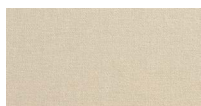

**KNOLL HOPSACK BY KNOLLTEXTILES**

Designer: KnollTextiles  
 Composition: 100% Wool  
 Durability: 40.000 Martindale / Lightfastness 4 (40hrs).  
 Sustainability: Greenguard Certification / Clean Air - Silver.



**MANNER BY MAHARAM**

Composition: 65% Post-Industrial Recycled Polyester, 35% Post-Consumer Recycled Polyester.  
 Durability: 300.000 double rubs Wyzenbeek / Lightfastness AATCC 16.3, 40+ hours.  
 Sustainability: Complies with Greenguard Gold Certification.

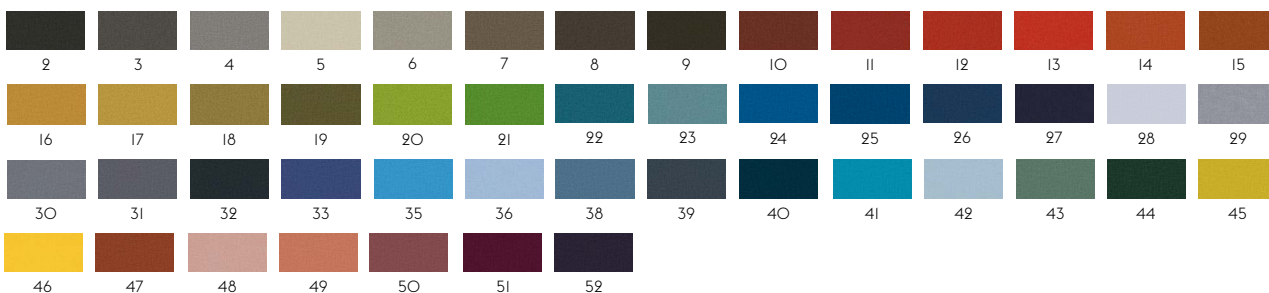

**MODERN TWEED BY KNOLLTEXTILES**

Designer: KnollTextiles  
 Composition: 47% Cotton, 23% Rayon, 14% Polyester, 8% Acrylic, 8% Wool  
 Durability: 40.000 Wyzenbeek Published / Lightfastness 4 (40hrs)  
 Sustainability: Greenguard Certification / Clean Air - Silver

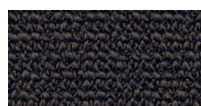
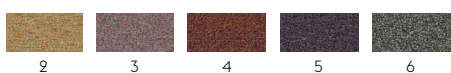

**OCEAN BY ROHLEDER**

Designer: Rohleder  
 Composition: 74 % Polyacrylic / 26 % Polyester  
 Durability: 30.000 Martindale / Lightfastness 5-7 (ISO 1-8)

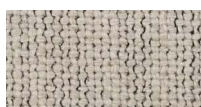

**PEBBLE WEAVE BY ONE MARIO SIRTORI**

Composition: 100% Trevira CS.  
 Durability: 45.000 Martindale / Lightfastness 4-5 (ISO 105-B02).







**PECORA BY XXXX**  
 Composition: Xxxx.  
 Durability: Xxxxx Martindale / Lightfastness XXXX.



6O49

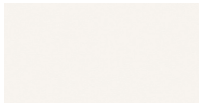
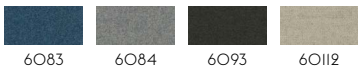

**PREMIER SILICONE BY KNOLLTEXTILES**  
 Designer: KnollTextiles  
 Composition: 100% SIO Medical Grade Silicone  
 Durability: 200.000 Wyzenbeek Published  
 Sustainability: Clean Air - Gold  
 Bleach Cleanable

1

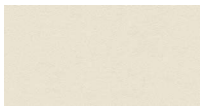
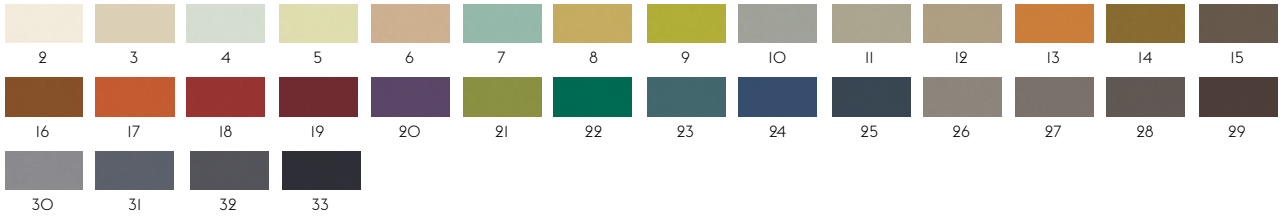

**PRAIRIE SILICONE BY KNOLLTEXTILES**  
 Designer: KnollTextiles  
 Composition: 100% Non-Phthalate Vinyl  
 Durability: 500.000 Wyzenbeek Published / Lightfastness 4 (1000hrs)  
 Sustainability: Greenguard Certification / Clean Air - Gold  
 Bleach Cleanable

1

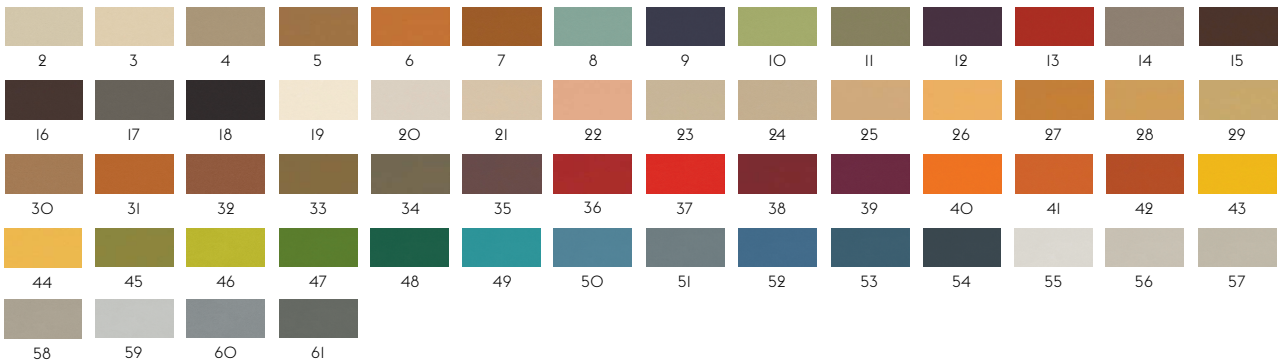

**REMIX BY KVADRAT**  
 Designer: Giulio Ridolfo.  
 Composition: 90% new wool worsted, 10% nylon.  
 Durability: 100.000 Martindale / Lightfastness 5-7 (ISO 1-8)  
 Sustainability: Complies with both EU ecolabel "The Flower" and Greenguard Gold Certification.



113

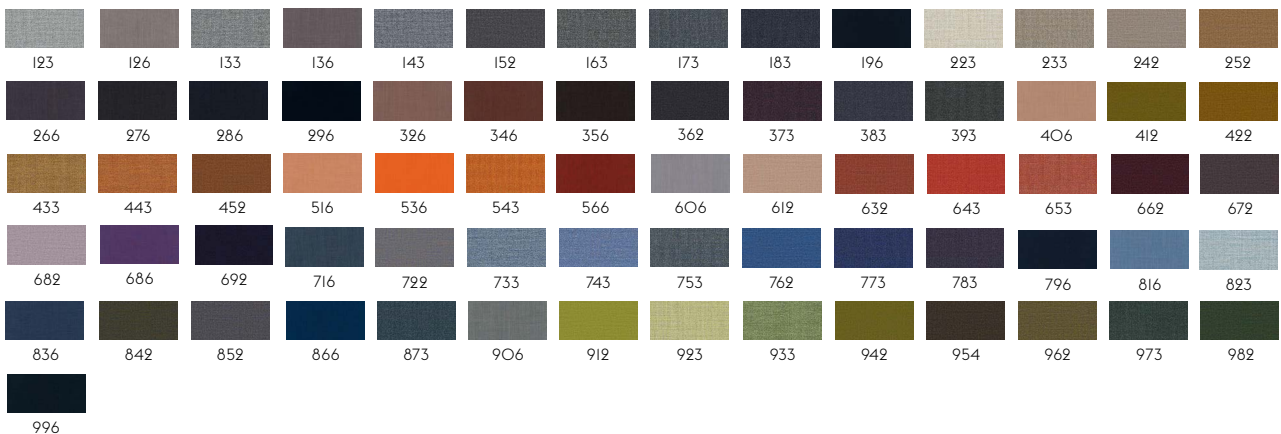



**RE-WOOL BY KVADRAT**

Designer: Margrethe Odgaard.

Composition: 45% new wool worsted, 45% recycled wool, 10% nylon.

Durability: 100,000 Martindale / Lightfastness 5-7 (ISO 1-8).

Sustainability: Complies with both EU ecolabel "The Flower" and Greenguard Gold Certification.

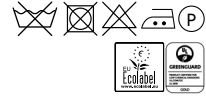

108

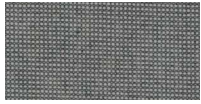

**SABI BY KVADRAT**

Designer: Louise Sigvardt

Composition: 65% New Wool, Worsted, 23% Recycled Wool, 12% Nylon

Durability: 80,000 Martindale / Lightfastness 5-7

Sustainability: Greenguard Gold, HPD, EPD

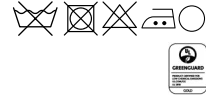

121

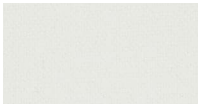
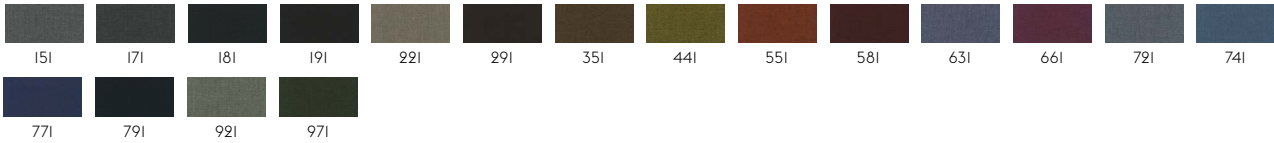

**STEELCUT BY KVADRAT**

Designer: Dijkmeijer & Ridolfo.

Composition: 90% new wool worsted, 10% nylon.

Durability: 80,000 Martindale / Lightfastness 5-7 (ISO 1-8).

Sustainability: Complies with both EU ecolabel "The Flower" and Greenguard Gold Certification.

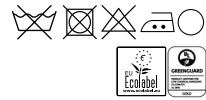

110

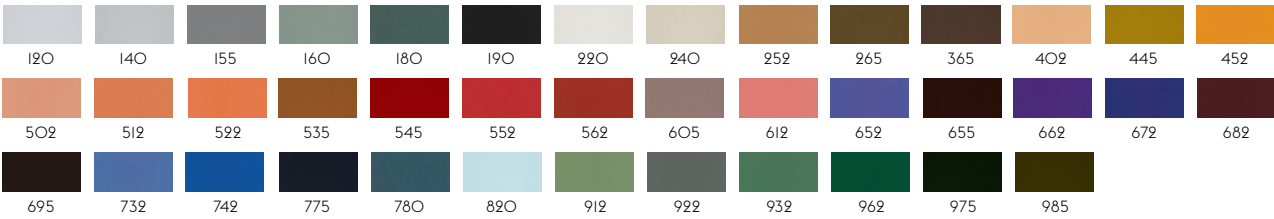

**STEELCUT TRIO BY KVADRAT**

Designer: Dijkmeijer & Ridolfo

Composition: 90% new wool worsted, 10% nylon.

Durability: 100,000 martindale / Lightfastness 5-7 (ISO 1-8).

Sustainability: Complies with both EU ecolabel "The Flower" and Greenguard Gold Certification.

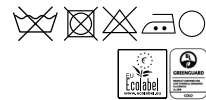

105

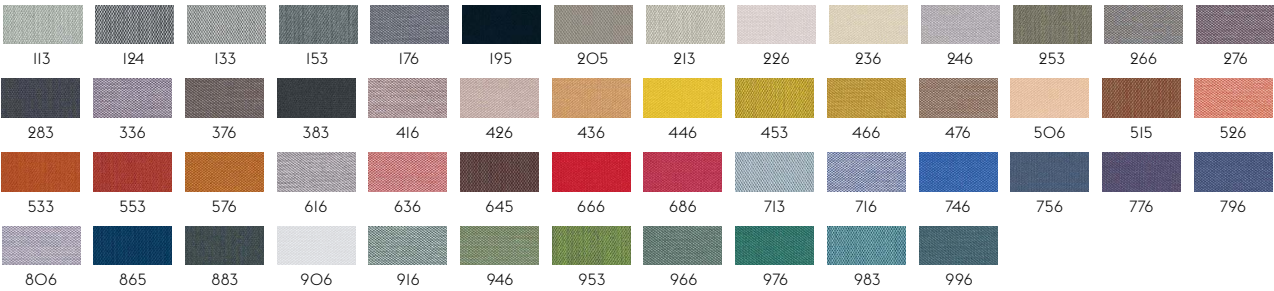



**STEELCUT QUARTET BY KVADRAT**

Designer: Dijkmeijer & Ridolfo.

Composition: 90% new wool worsted, 10% nylon.

Durability: 100.000 Martindale / Lightfastness 6-7 (ISO 105-B02).

Sustainability: Complies with both EU ecolabel "The Flower" and Greenguard Gold Certification.



114

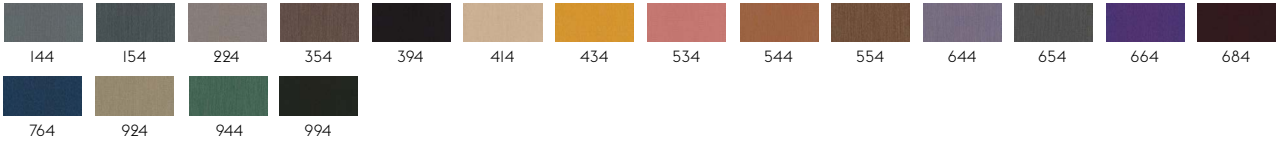

**STRETCH APPEAL BY KNOLLTEXTILES**

Designer: KnollTextiles

Composition: 78% Wool, 20% Mohair, 2% PU (Elasthan).

Durability: 100.000 Wyzenbeek / Lightfastness 4 (40hrs).

Sustainability: Greenguard Certification / Clean Air - Silver.



2

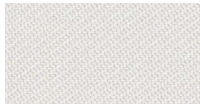

**TWILL WEAVE BY KVADRAT**

Designer: Jonathan Olivares

Composition: 90% new wool (worsted), 10% nylon

Durability: 60.000 Martindale

Sustainability: Complies with both EU ecolabel "The Flower" and Greenguard Gold Certification.

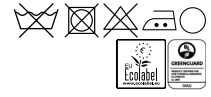

110

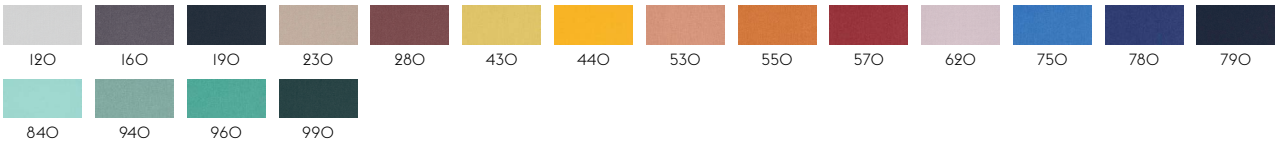

**VANCOUVER BY ROSSINI DELLA QUERCIA**

Designer: Gabriella Zecca

Composition: 52% cotton, 48% acrylic.

Durability: 40.000 Martindale / Lightfastness 4-5.

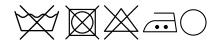

4



**VIBE II BY KNOLLTEXTILES**

Designer: KnollTextiles

Composition: 100% Polyurethane

Durability: 100.000 Wyzenbeek Published / Lightfastness 5 (200hrs)

Sustainability: Clean Air - Gold

Bleach Cleanable

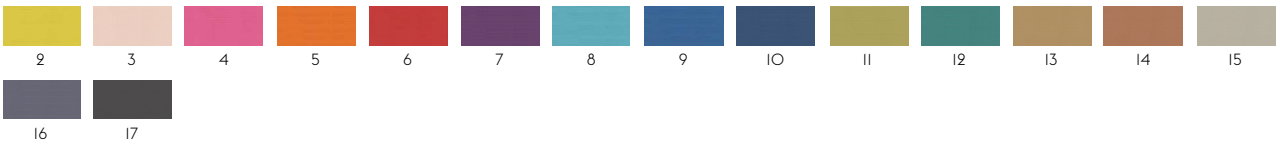

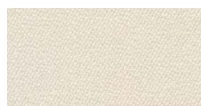

**VIDAR BY KVADRAT**

Designer: Raf Simons & Fanny Aronsen for Kvadrat.

Composition: 94% new wool, 6% nylon.

Durability: 100.000 Martindale / Lightfastness 6-7.

Sustainability: Natural fibres / Sustainable resource. Complies with Greenguard Gold Certification.



106

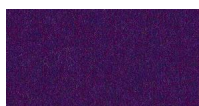
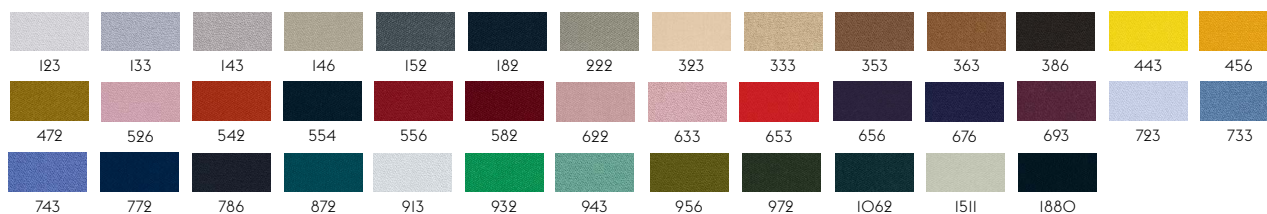

**WOOLY BY NEVOTEX**

Designer: Nevotex

Composition: 70% wool, 25% polyamide, 5% other fibres.

Durability: 150.000 Martindale / Lightfastness 6-8.

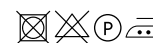

0091

Wooly is woven in 70% recycled wool, sourced from leftover materials of clothing production and other wool products. One kilo of pure new wool generates 9 kilograms of carbon dioxide when produced while processing one kilo of recycled wool only generates 0.5 kilograms of carbon dioxide. Furthermore, recycled wool has a positive environmental impact due to lessened water consumption and lower energy consumption.

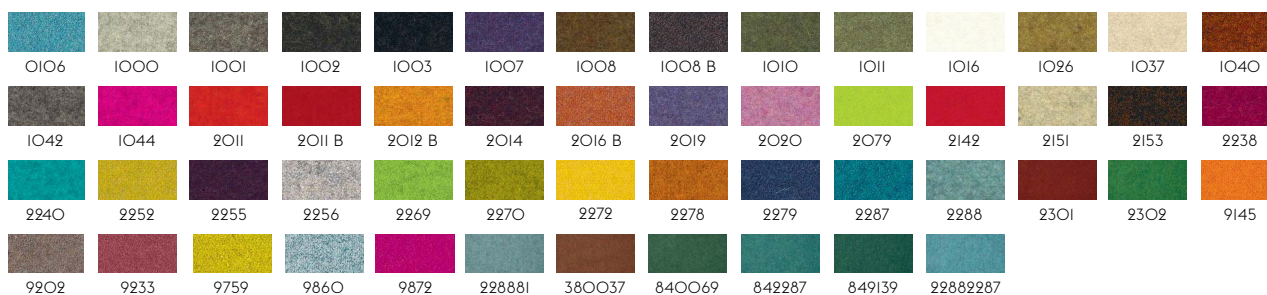



# LEATHER OPTIONS

At Muuto, we work with some of the leading leather suppliers to ensure that the leather used for our designs is always of the highest possible standard. Our leather options range from the Refine Leather, a modern and sleek full-grain leather with a soft touch, over Easy Leather, a lightly buffed natural grain leather with a soft and waxy feel along with a matte look, to our Endure Leather, a pliable and extremely durable semi-aniline leather ideal for hard contract environments, and the Volo Leather from Spinneybeck, a chromium-tanned, aniline-dyed leather that has been specially retanned for an enriched and soft feel.



CHAL

## ALLURE LEATHER

Soft nubuck aniline leather from European raw hides, known for its exclusive appeal and soft, velvety feel. The leather is dyed through, chrome tanned and produced without the use of PCP and CFC which can be damaging to the environment.



ZINC

## EASY LEATHER

Lightly Buffed Natural Grain Leather  
Raw material: Designed and processed in Italy. The leather is dyed through, chrome tanned and finishing is with resins and pigments.

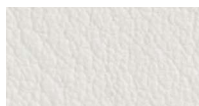
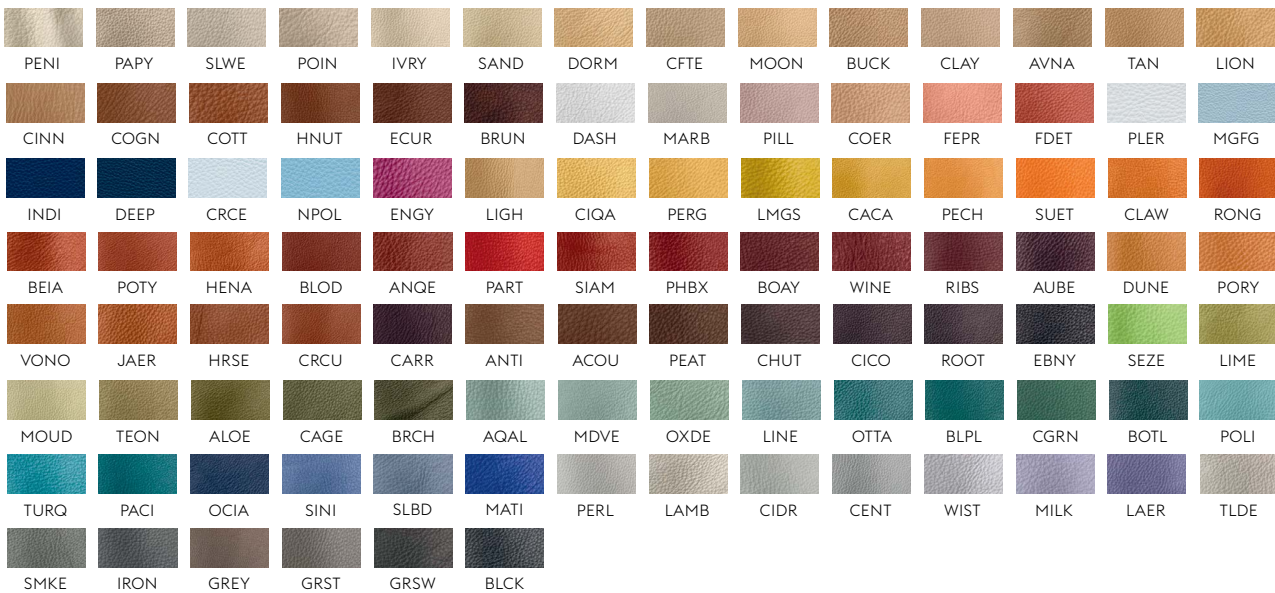

CWIT

## ENDURE LEATHER

Semi-aniline leather with high durability, making it ideal for contract environments.  
Raw material: Leather from Scandinavian raw hides.  
The leather is dyed through a chrome free tanning process. Also available in custom colors in a minimum of 1 hide.





ANTH

**GRACE LEATHER**

Aniline leather from European raw hides with a natural look and velvety feel, characterized by the natural markings and imperfections that give it a distinct beauty. The leather is dyed through, tanned without chrome and produced without the use of PCP and CFC which can be damaging to the environment.



CREM

**REFINE LEATHER**

Aniline Leather.  
Raw material: Grain leather from European raw hides. The leather is dyed through, chrome tanned and produced without the use of PCP and CFC which can be damaging to the environment.

