

CLEANING — NETTOYAGE — LIMPIEZA

- EN Turn off electricity, clean with dry cloth.
- FR Eteindre l'électricité, nettoyer avec un chiffon humide.
- ES Apague la electricidad, limpie con un paño seco.

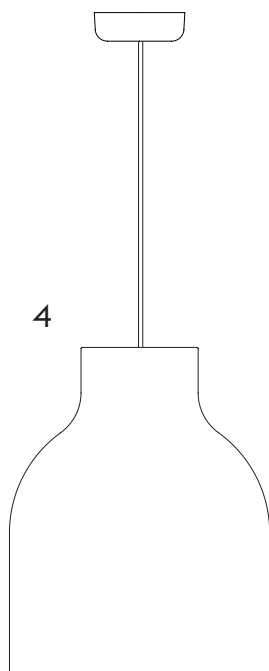

STRAND PENDANT LAMP

— Benjamin Hubert

ASSEMBLY INSTRUCTION — INSTRUCTIONS DE MONTAGE —
INSTRUCCIONES DE MONTAJA

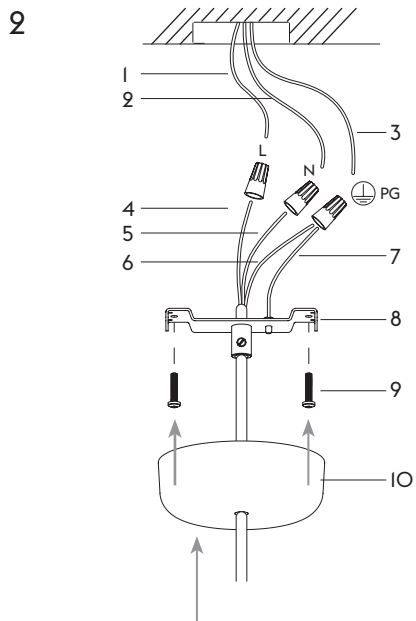
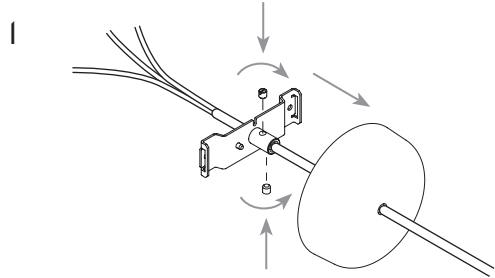

- 1 Black supply cord (L)
- 2 White supply cord (N)
- 3 Green supply cord (PG)
- 4 Black fixture cord (L)
- 5 White fixture cord (N)
- 6 Green fixture cord (PG)
- 7 Green crossbar cord (PG)
- 8 Crossbar
- 9 Mounting screws
- 10 Decorative cover

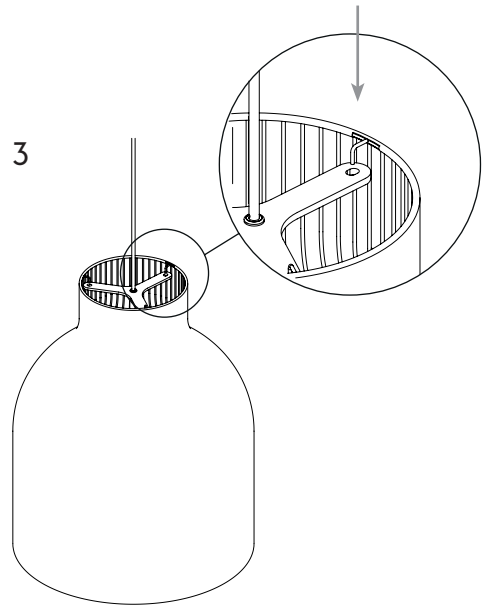

INSTALLATION & OPERATING INSTRUCTIONS

CAUTION!

Before assembling your lighting fixture, refer to the section entitled ELECTRICAL CONNECTIONS. If you feel you do not have electrical wiring experience, consult a qualified licensed electrician before installing.

WARNING!

Most dwellings built before 1985 have supply wire rated 60. Some fixtures require supply wire rated for temperatures greater than 60 and are so identified on packaging and on the fixture's supply wires. Consult a qualified licensed electrician before installing.

GENERAL

1. To ensure the success of the installation, review the diagrams and instructions thoroughly before beginning.
2. All electrical connections must be in accordance with local codes, ordinances, and the National Electrical Code.
3. These fixtures are intended to be connected to a standard 4" x 2-1/8" UL Listed outlet box directly supported by the building structure.
4. Before starting the installation, disconnect the power supply by turning off the circuit breaker or by removing the fuse at the power off. Using the light switch is not sufficient to prevent electrical shock.

NOTE

The safeguards and instructions appearing in this manual are not meant to cover all possible conditions and situations that may occur. It must be understood that common sense, caution, and reasonable care are factors which cannot be built into any product, these factors must be supplied by the person(s) caring for and operating the fixture.

CAUTION!

TURN OFF ELECTRICITY BEFORE PROCEEDING!

PREPARE THE FIXTURE & OUTLET BOX (See the diagram)

1. If replacing an existing fixture, disconnect and remove the old fixture. Expose the supply wiring from the outlet box.
2. Feed fixture wires through crossbar. (4, 5, 6)
3. Attach crossbar to the outlet box using the two screws supplied with the outlet box. (8, 9)
4. Make electrical connections. Refer to the ELECTRICAL CONNECTIONS section below.

ELECTRICAL CONNECTIONS

NOTE: Use UL listed wire connectors suitable for the size, type, and number of conductors. No loose strands or loose wires should be present. Secure all splices with UL listed electrical tape.

1. Connect the green protective earth cord of the supply circuit to the green grounding cord extending from the crossbar and the green lead cord of the fixture. (3, 6, 7)
2. Connect the white supply cord to the white neutral lead cord of the fixture. (2, 5)
3. Connect the black supply cord to the black line lead cord of the fixture. (1, 4)

FINAL ASSEMBLY

1. Spread electrical splices so that the black supply lead wire is on one side of the outlet box and the common and grounding conductors are on the other. Splices should carefully be turned inward inside the outlet box.
2. Place the fixture so the outlet box and splices are completely covered by the decorative cover.
3. Fixture assembly, please refer to the drawing.
4. Insert light bulb. Refer to the lamping information supplied on the fixture.
5. Restore power

Your fixture is now ready for use.

STRAND PENDANT LAMP Ø40 OPEN
IX E26 - MAX 40W INCANDESCENT
OR SBCFL MAX 13W OR SBLED MAX 13W
120V ~ 60HZ
ONLY FOR INDOOR USE.