

IN SITU MODULAR SOFA Corner Configuration 6

— Anderssen & Voll

1

Place all components on a flat, clean and soft surface to avoid scratches and to get an overview of all parts that are needed to assemble your sofa.

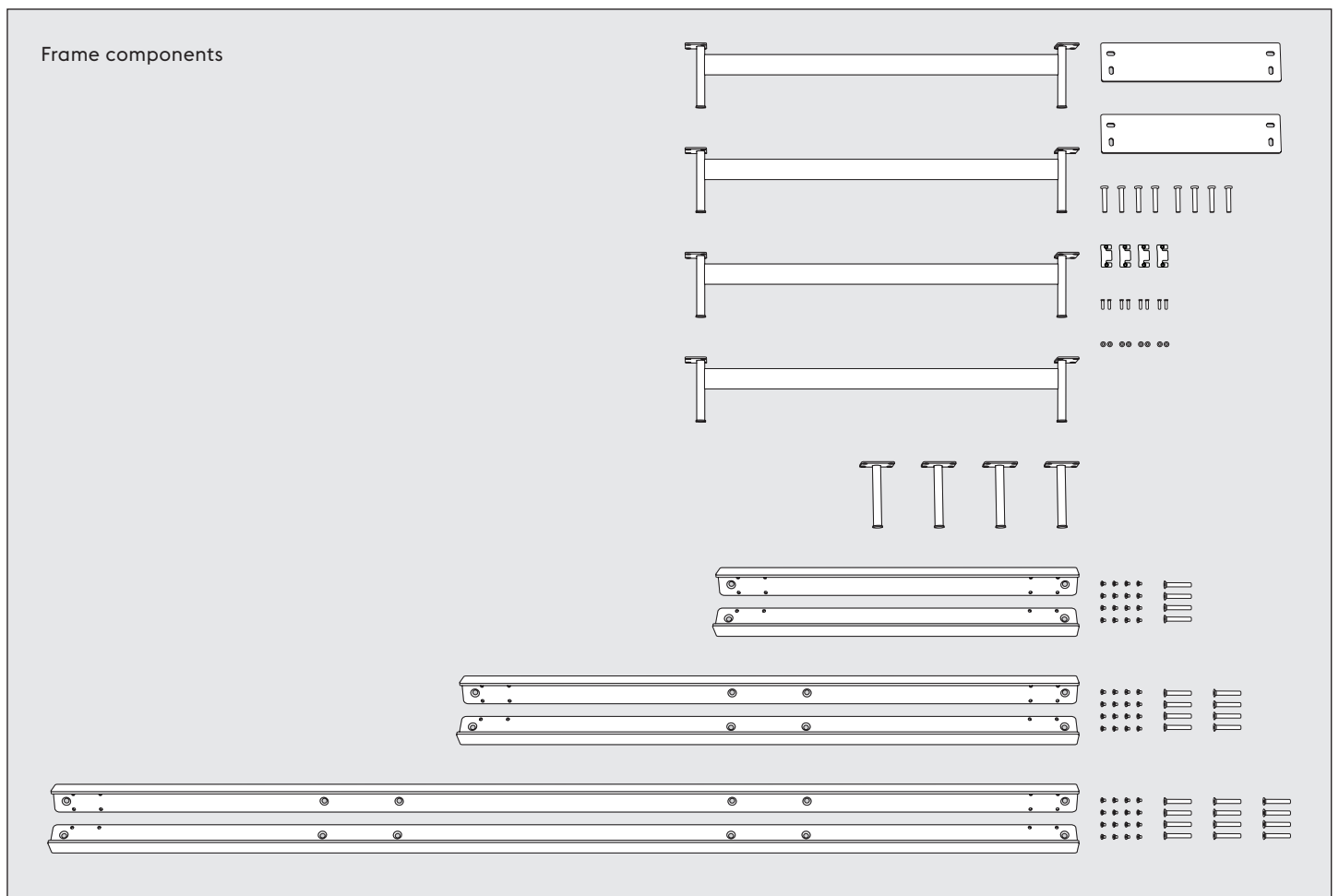
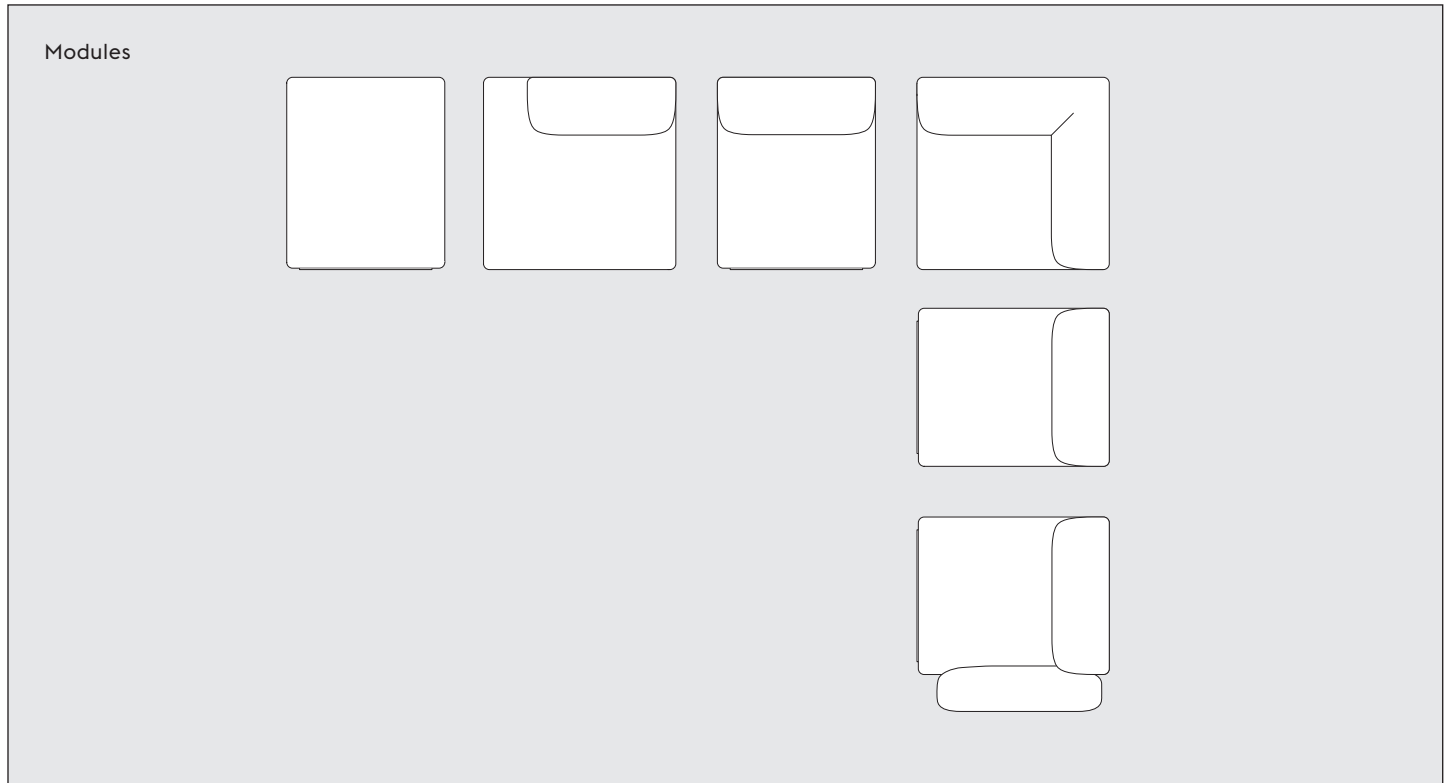

Make sure you have received all components needed.

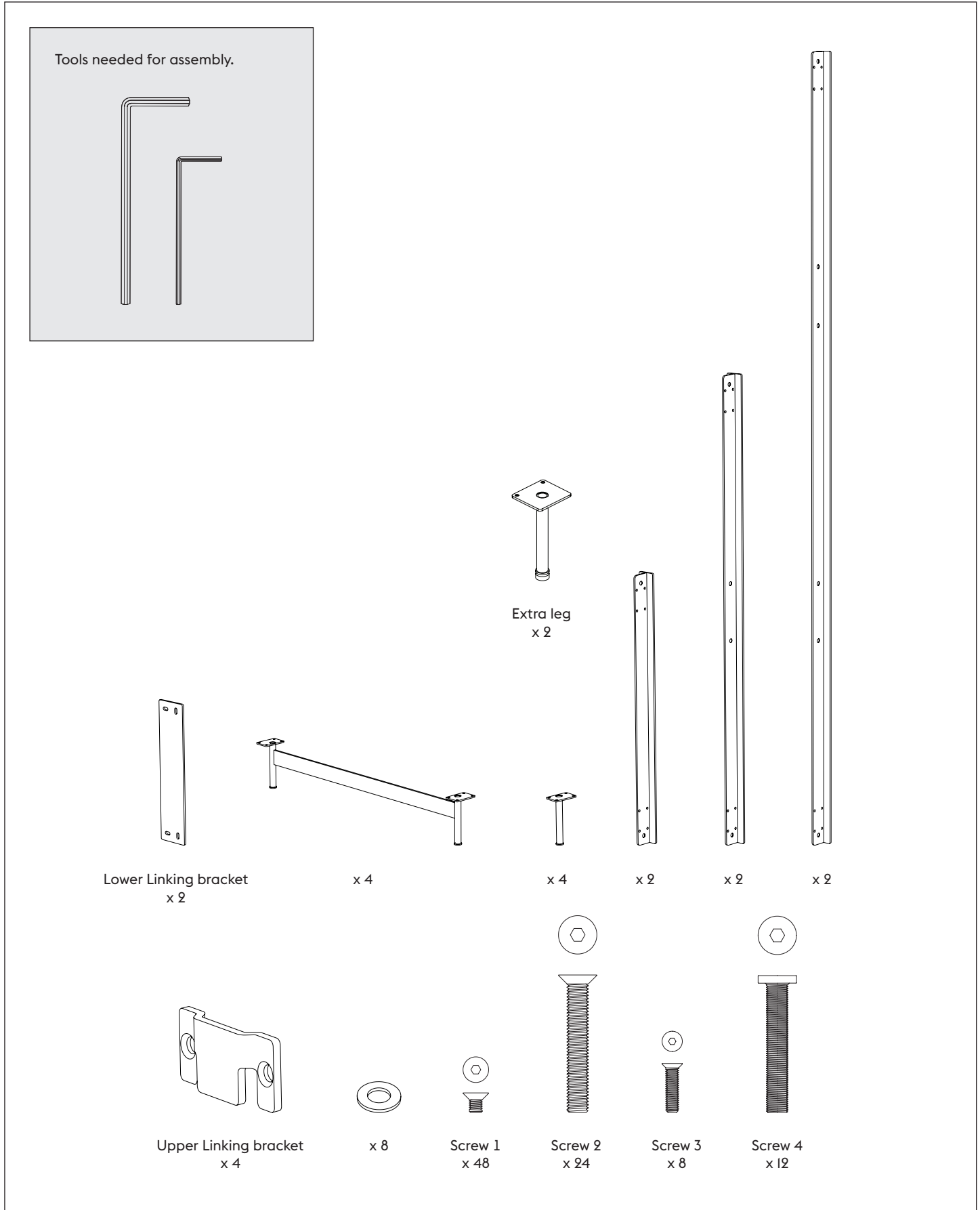

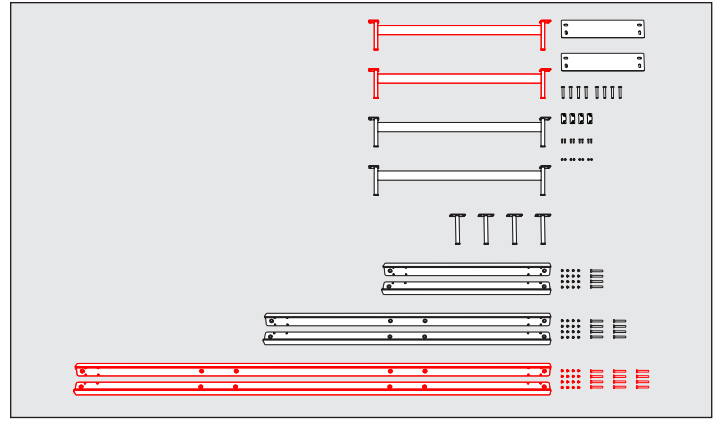
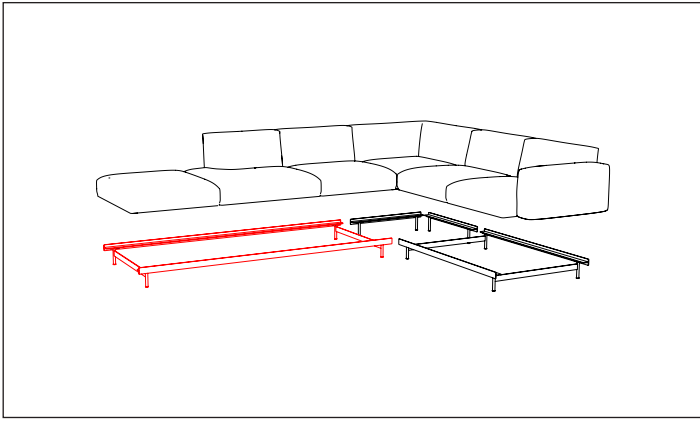

Assembling the first straight section:

Place needed components on the floor and fasten legs to bars with screws.

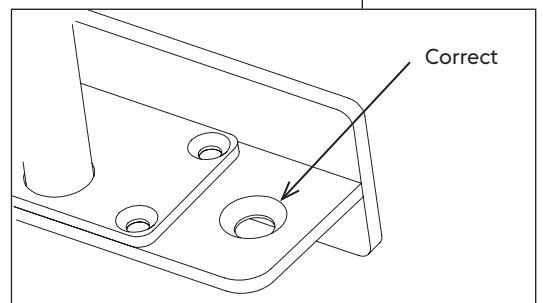
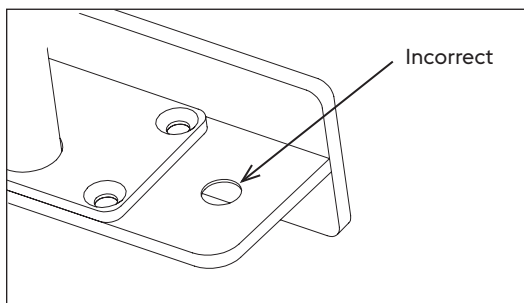
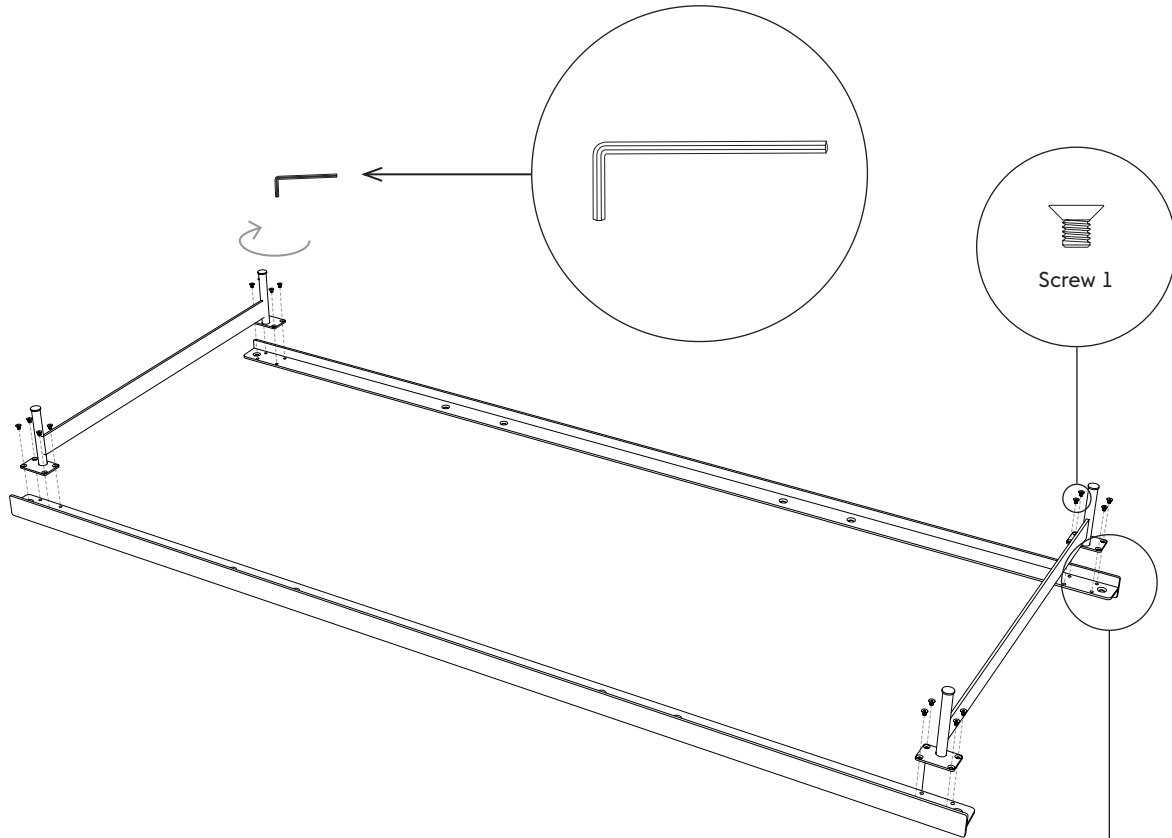

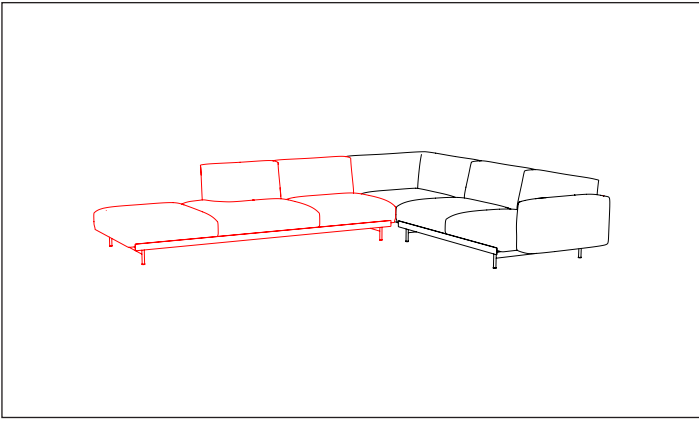

Starting from one side/end of the frame section, attach the individual modules loosely without leaving any gap in between.

When all modules are attached, secure the modules by tightening the screws.

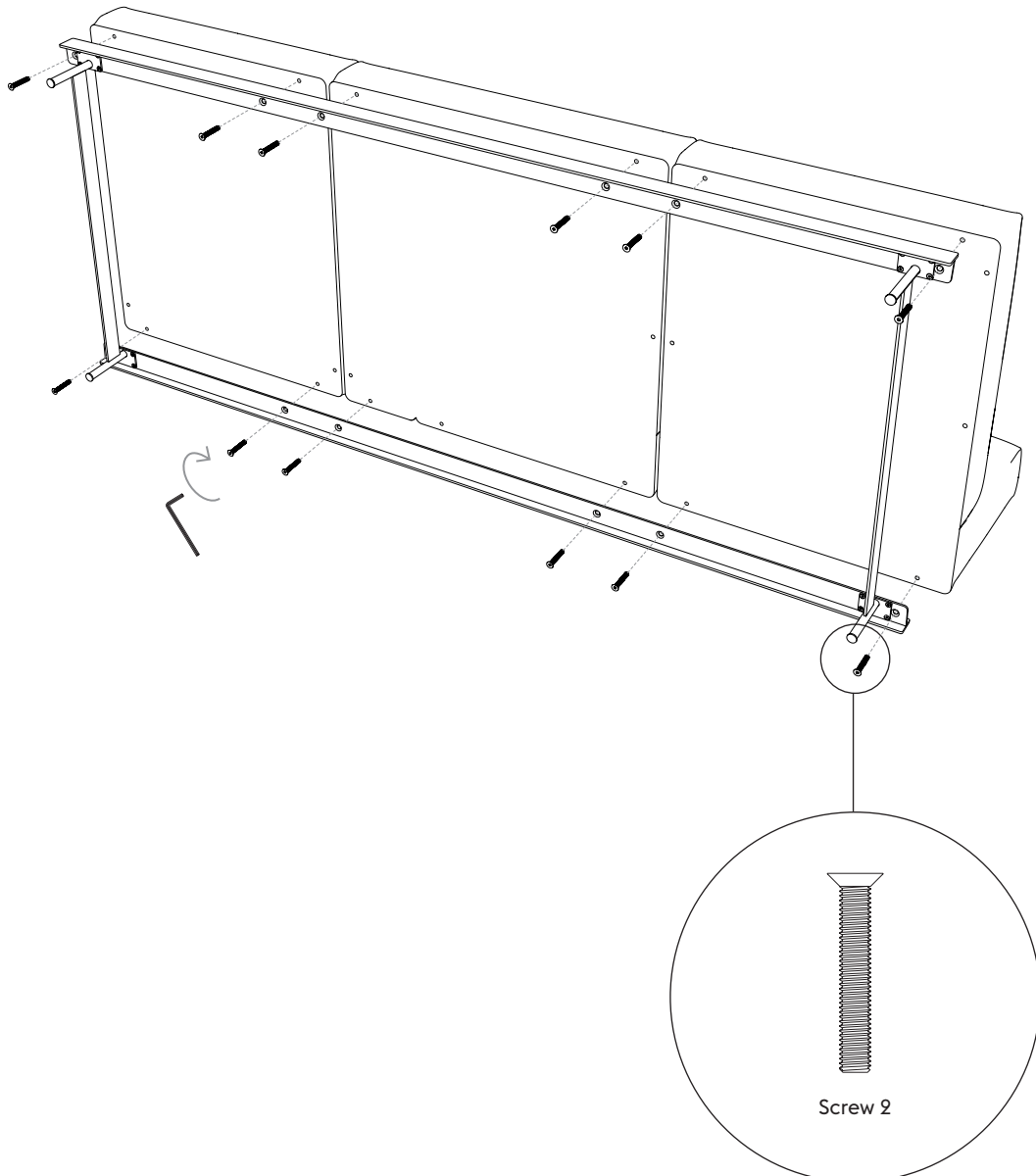

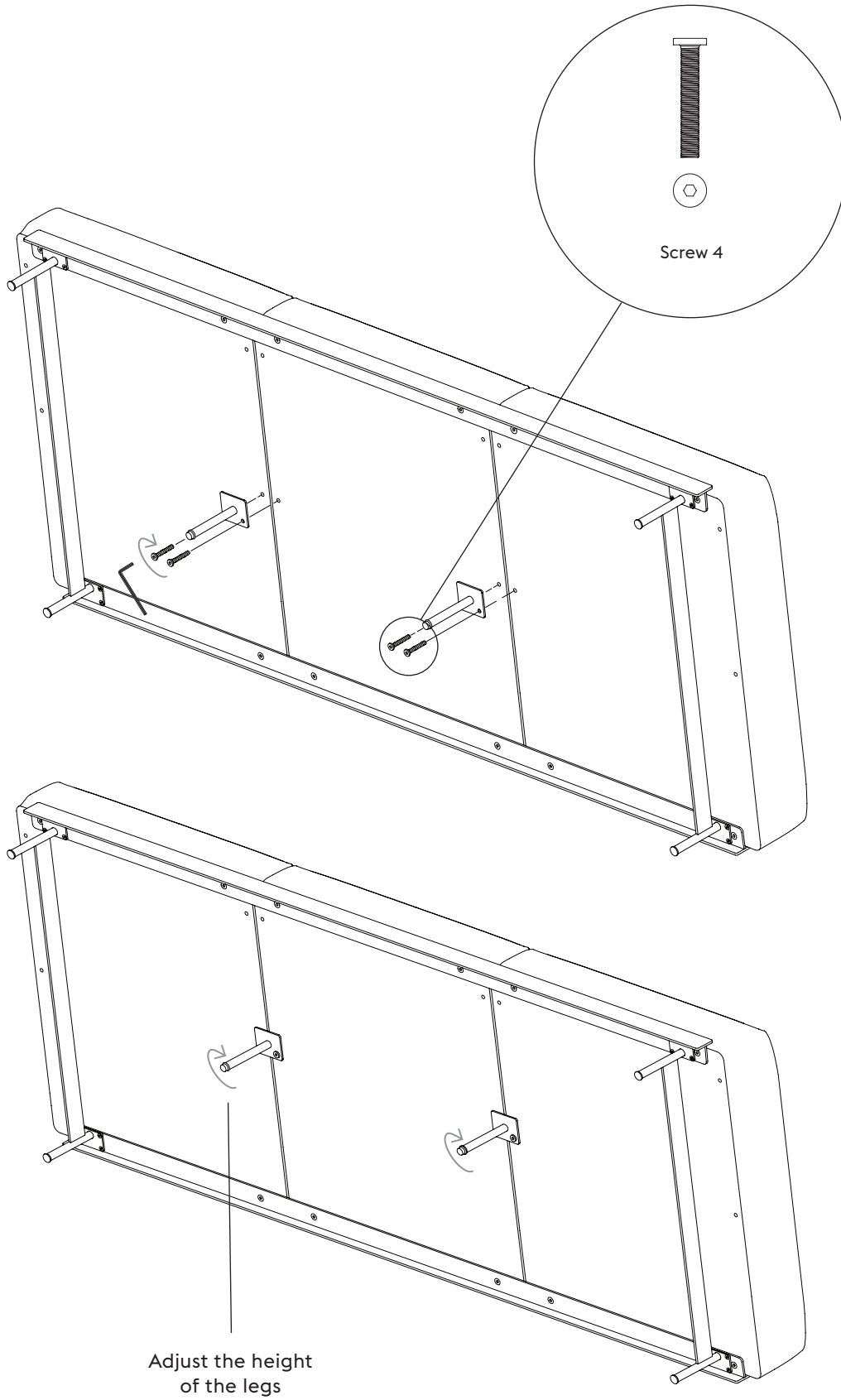

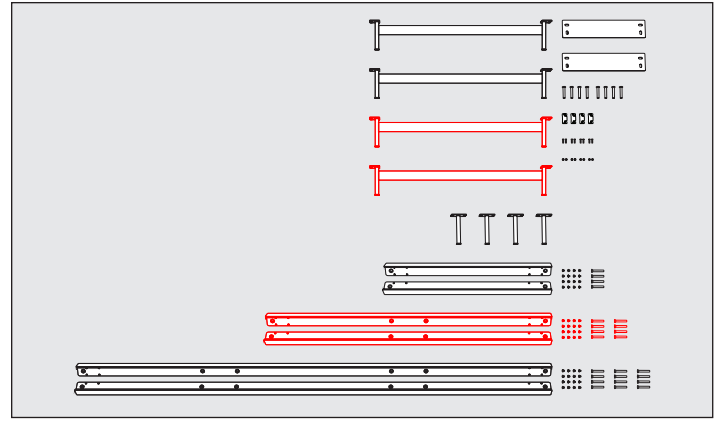
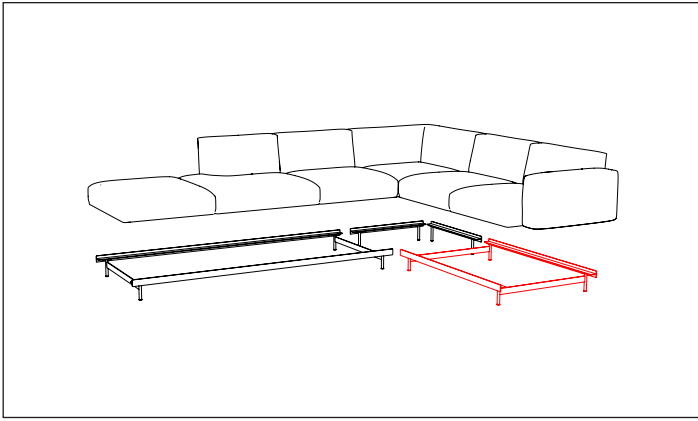

Assembling the second straight section:

Assemble the second straight frame section as before, and attach the multiple modules to the assembled frame section.

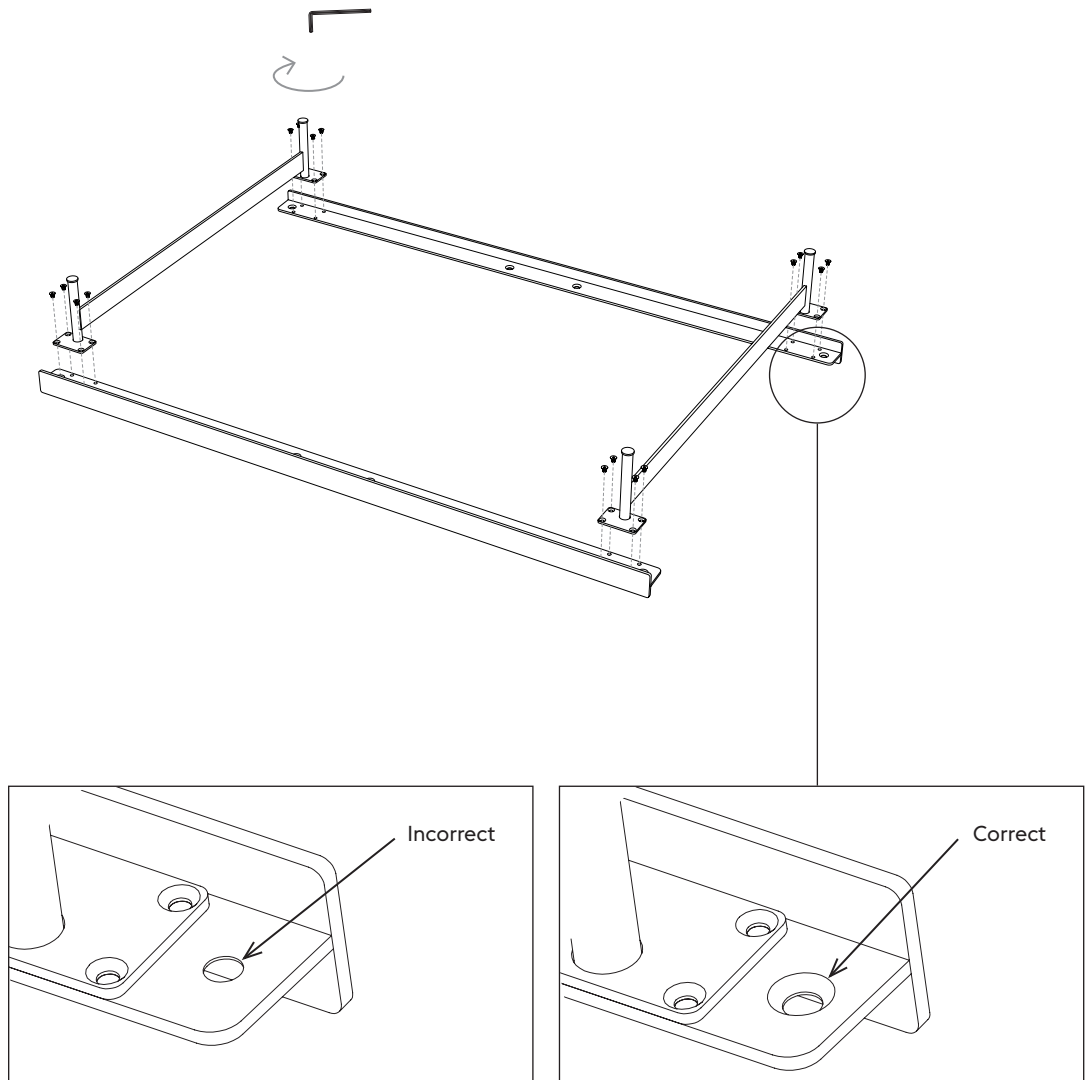

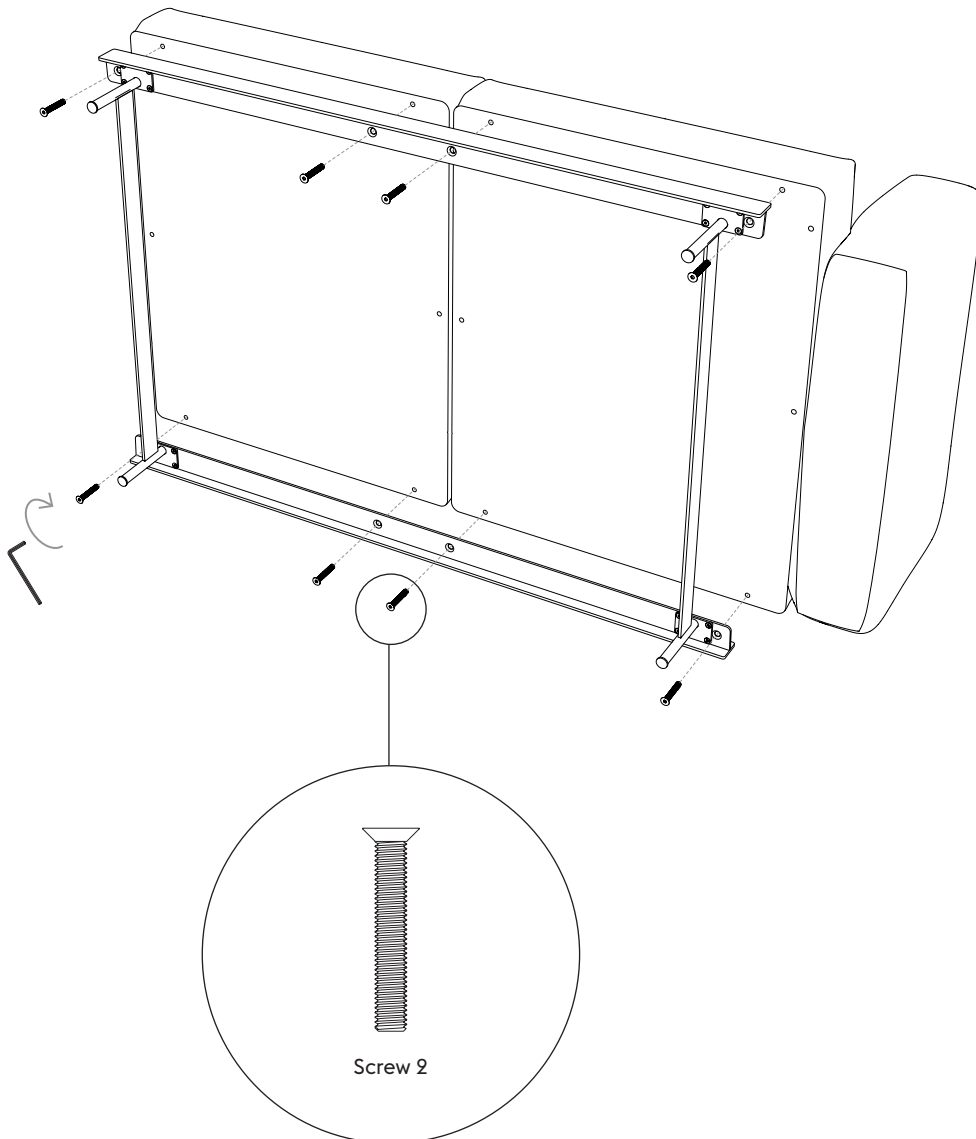
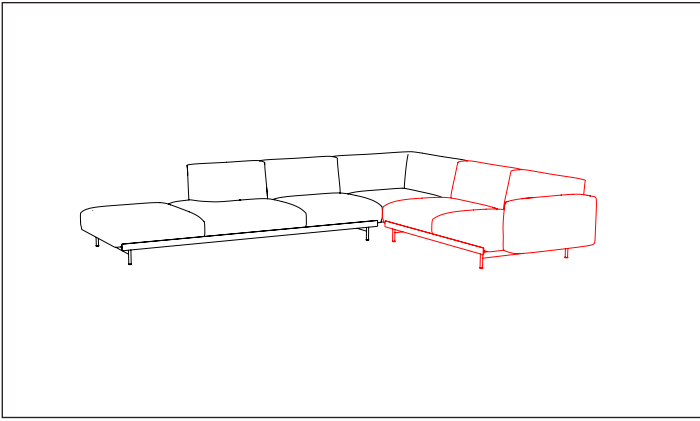

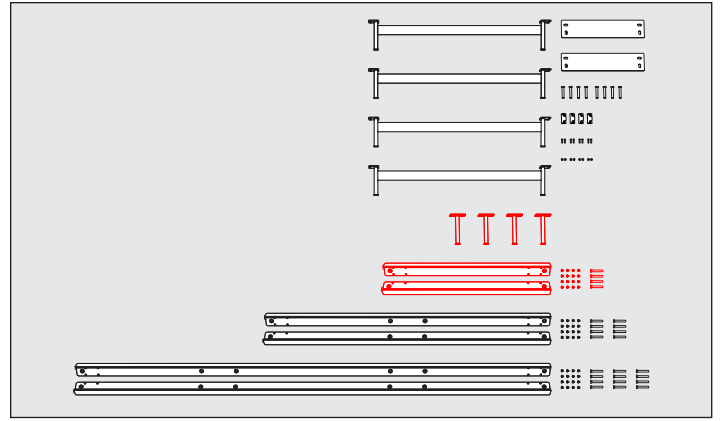
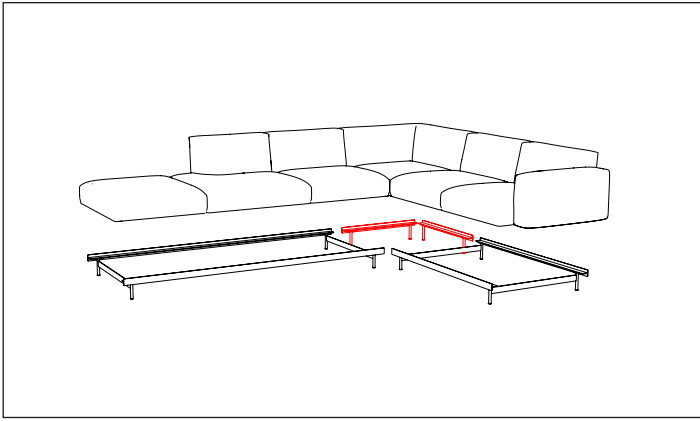

Assembling the corner section:

Place the needed components on the floor and fasten legs to the bars.

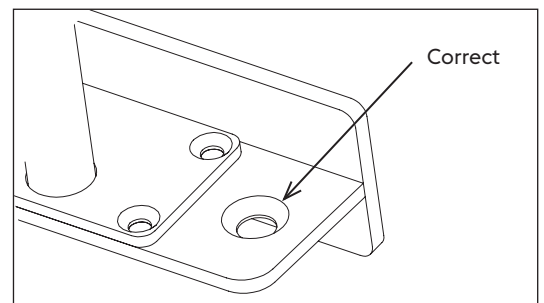
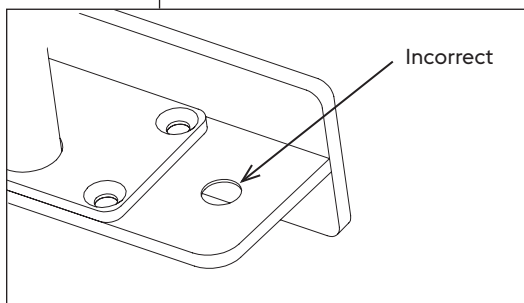
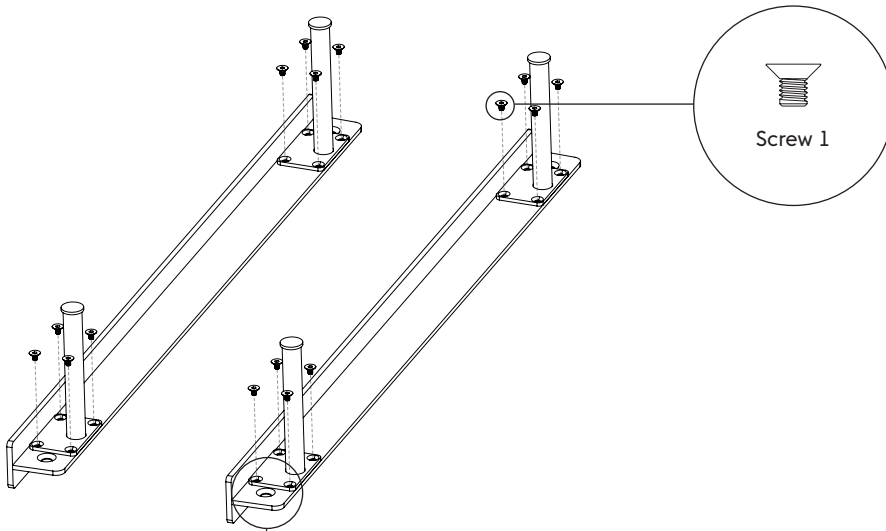

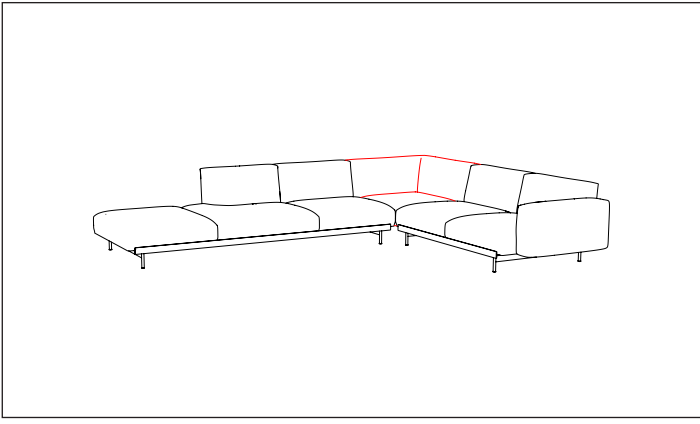

Then attach the assembled frame section to the corner module.

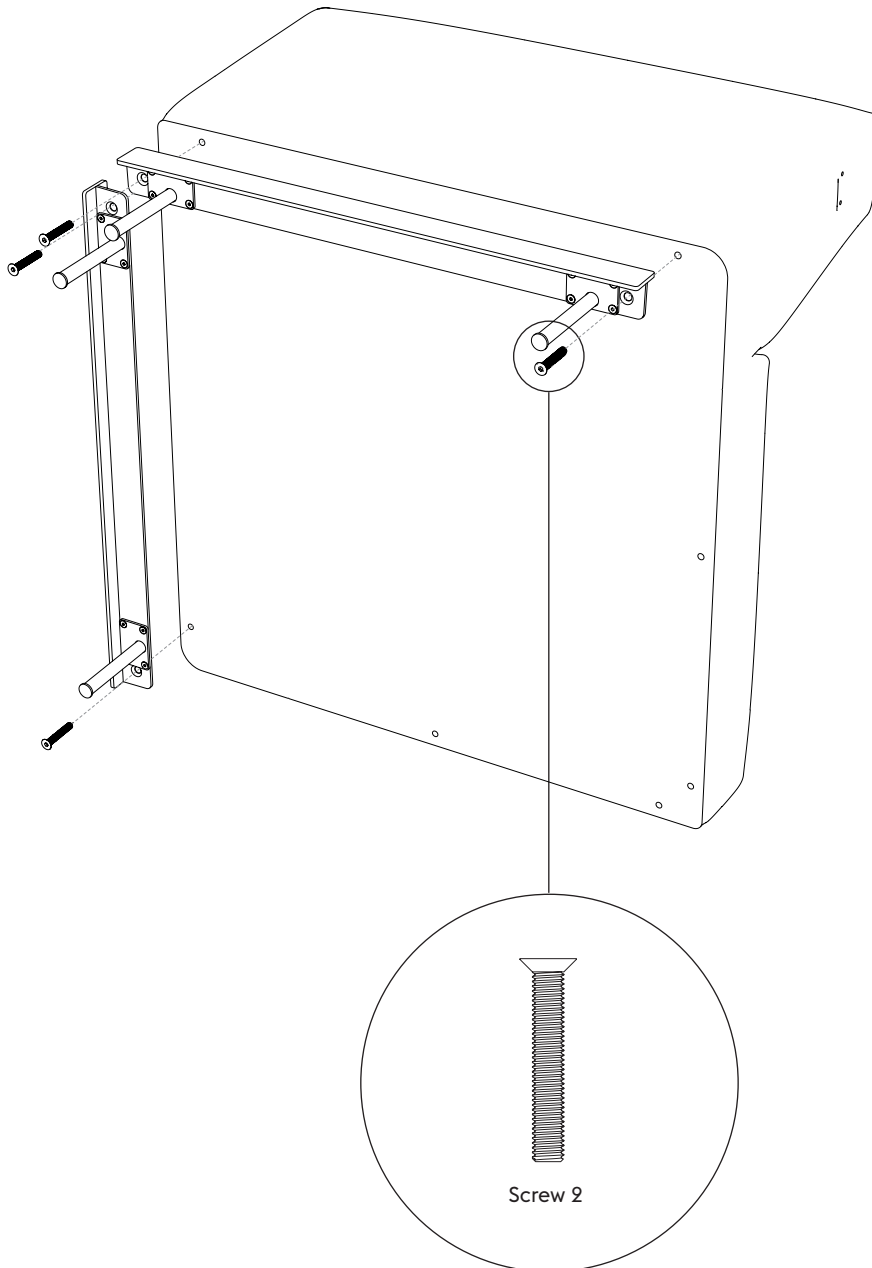

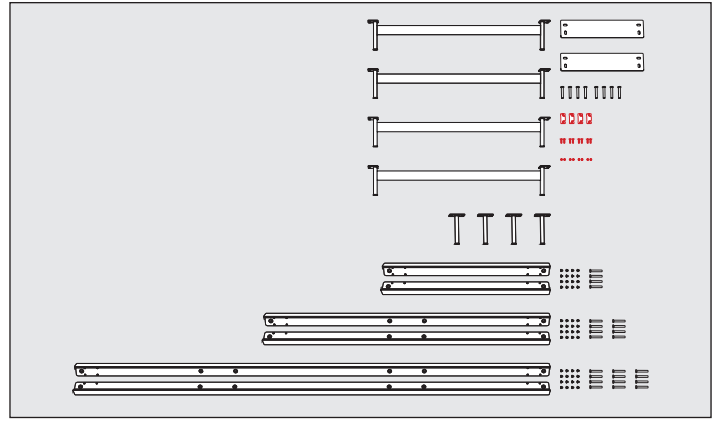
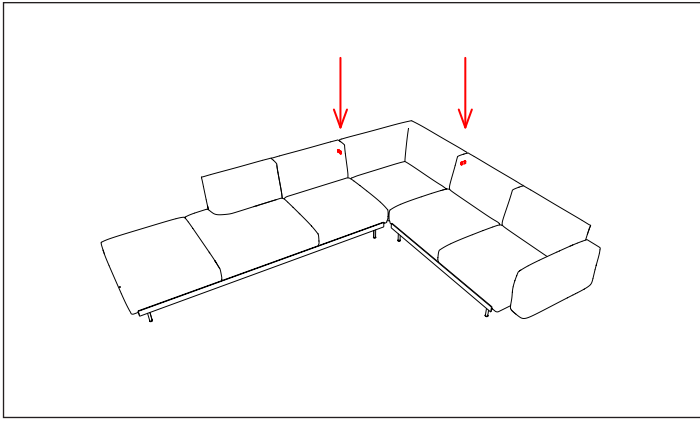

With screw 3, attach the upper linking brackets as shown. Make sure to have both sides facing down.

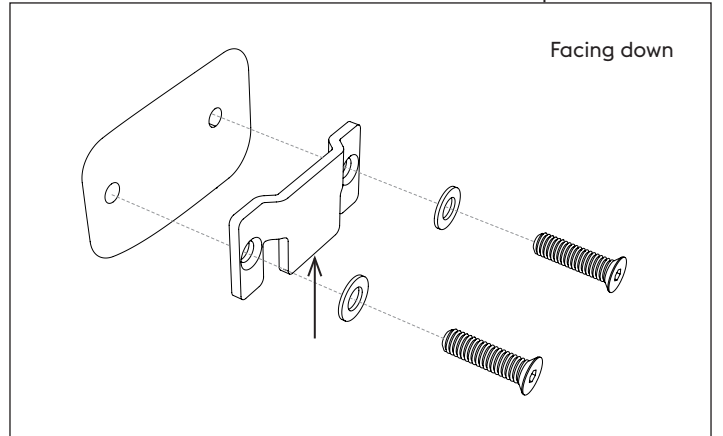
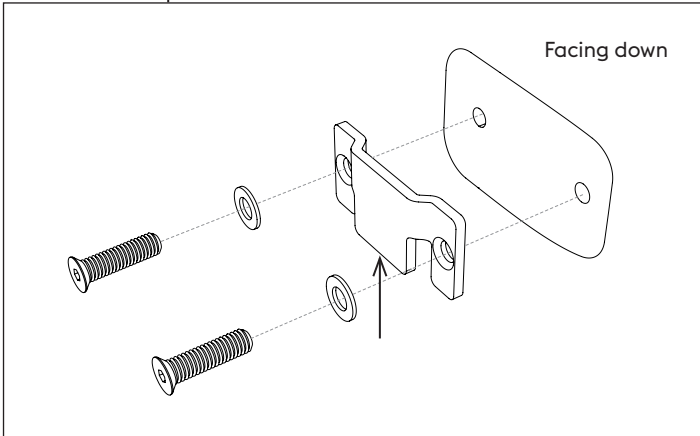
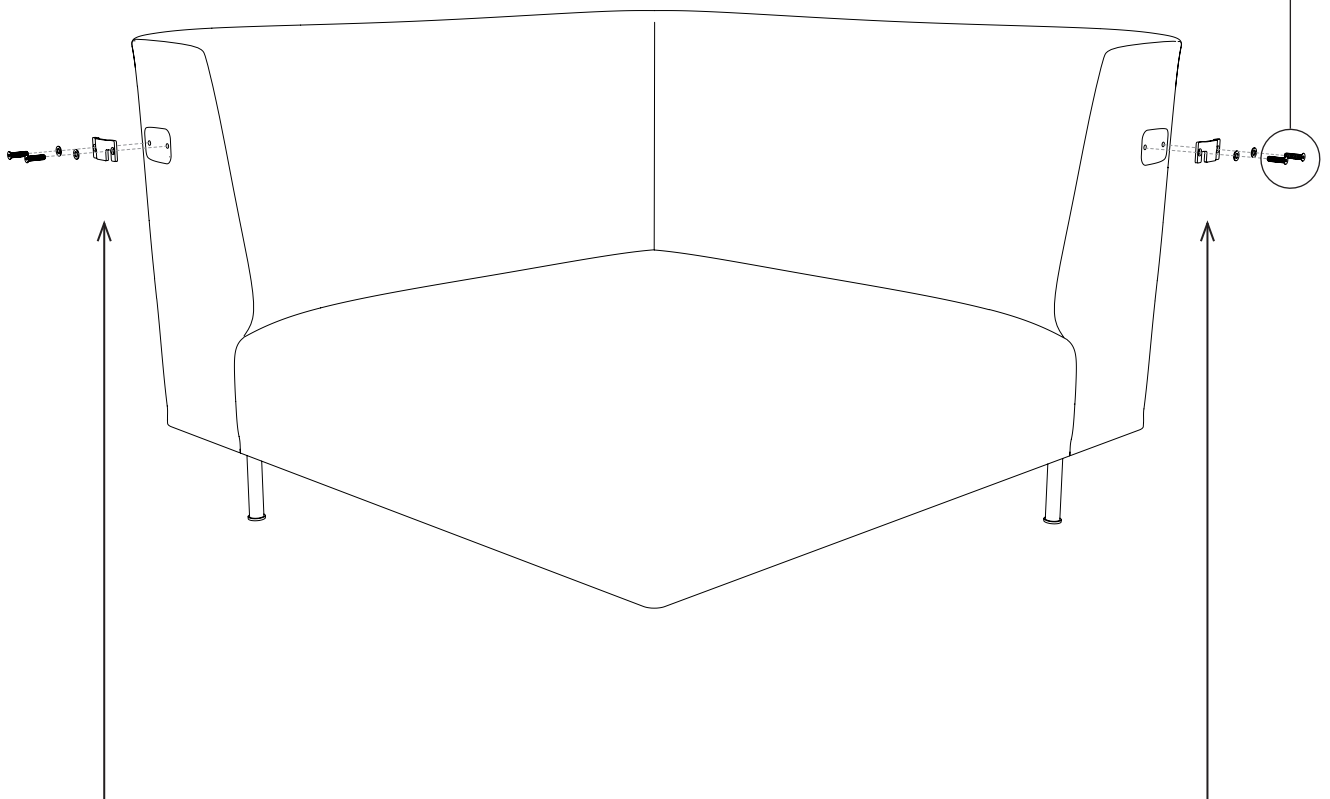

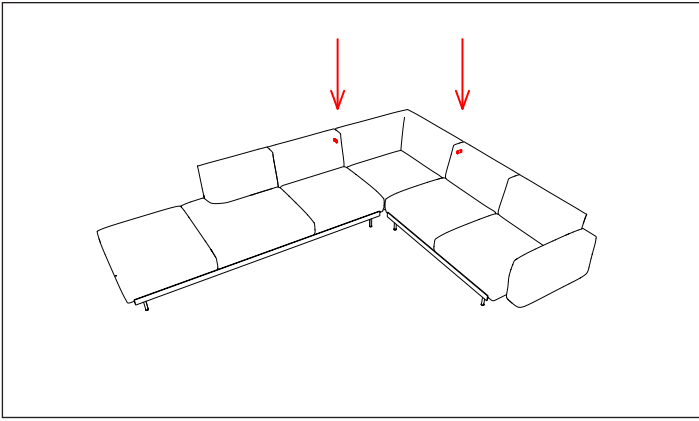

With screw 3, attach the upper linking brackets as shown. Make sure to have both sides facing up.

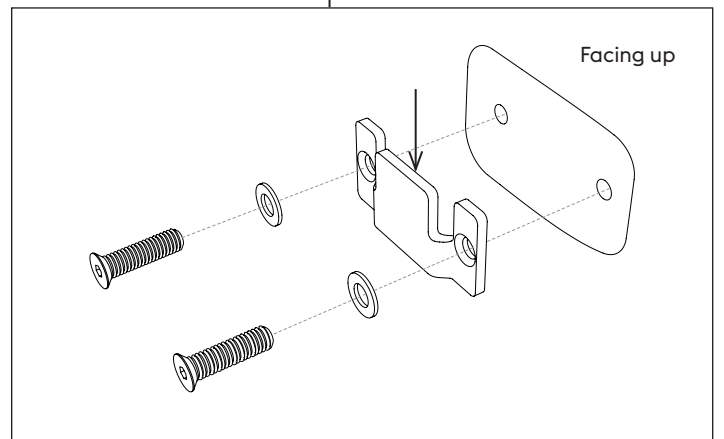
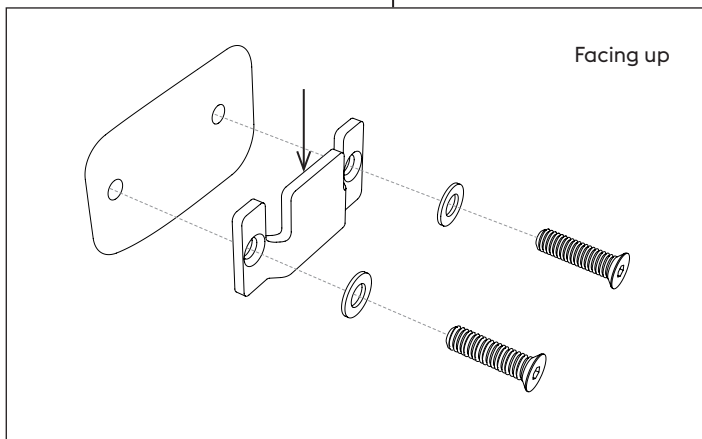
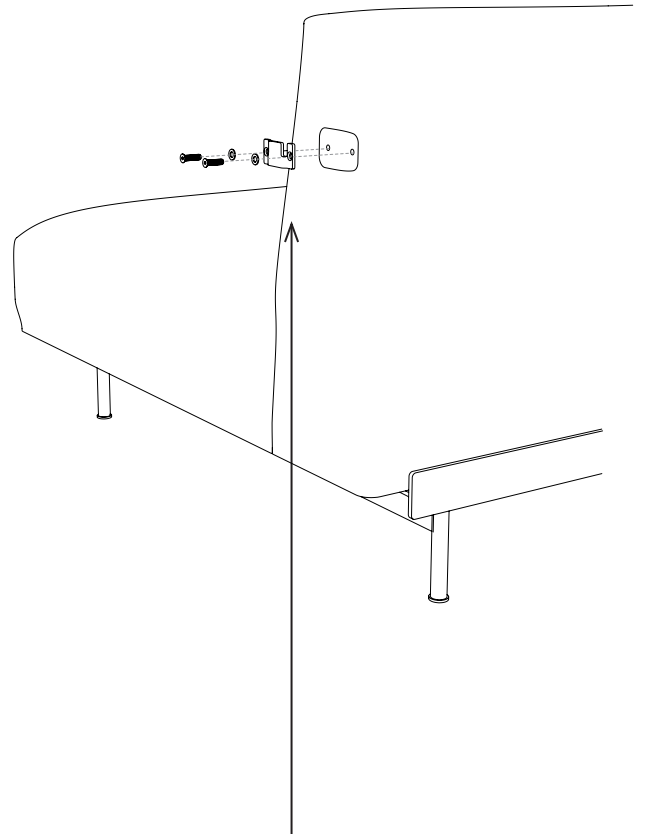
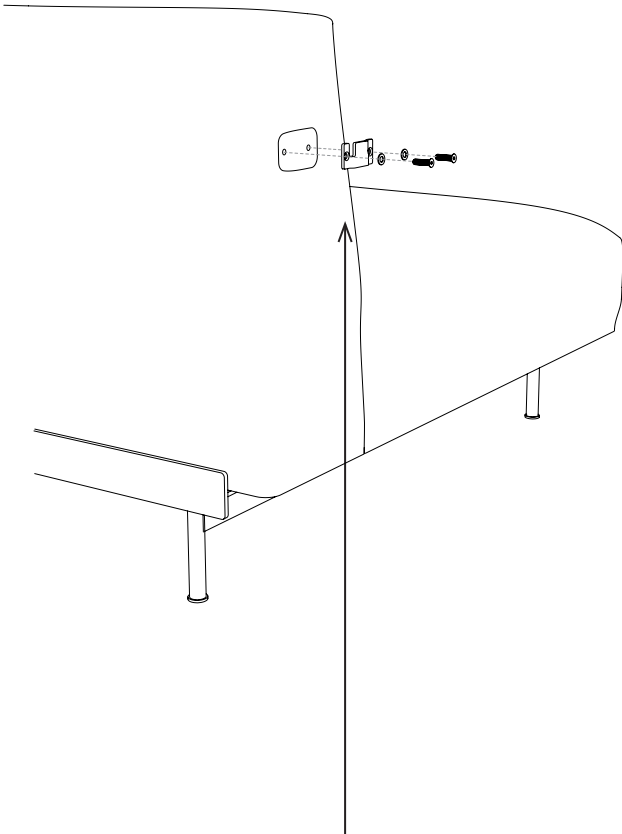

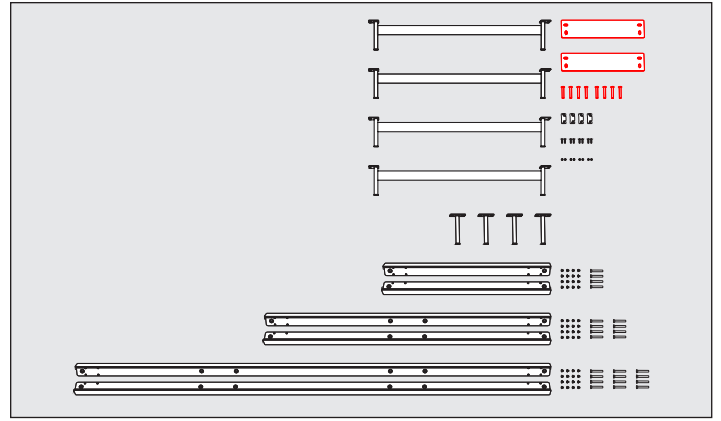
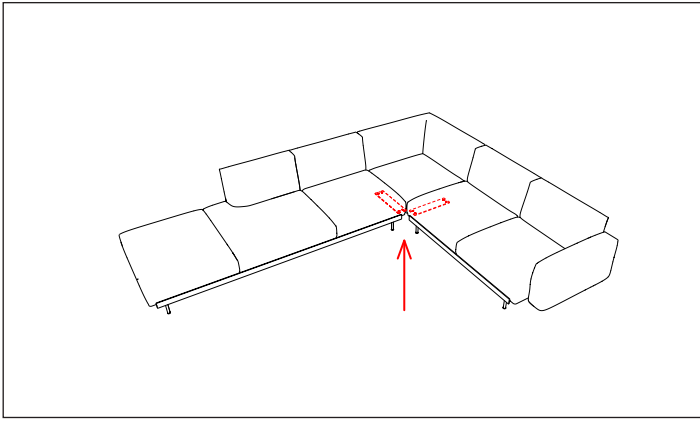

Attach the two lower linking brackets to the two straight sections.

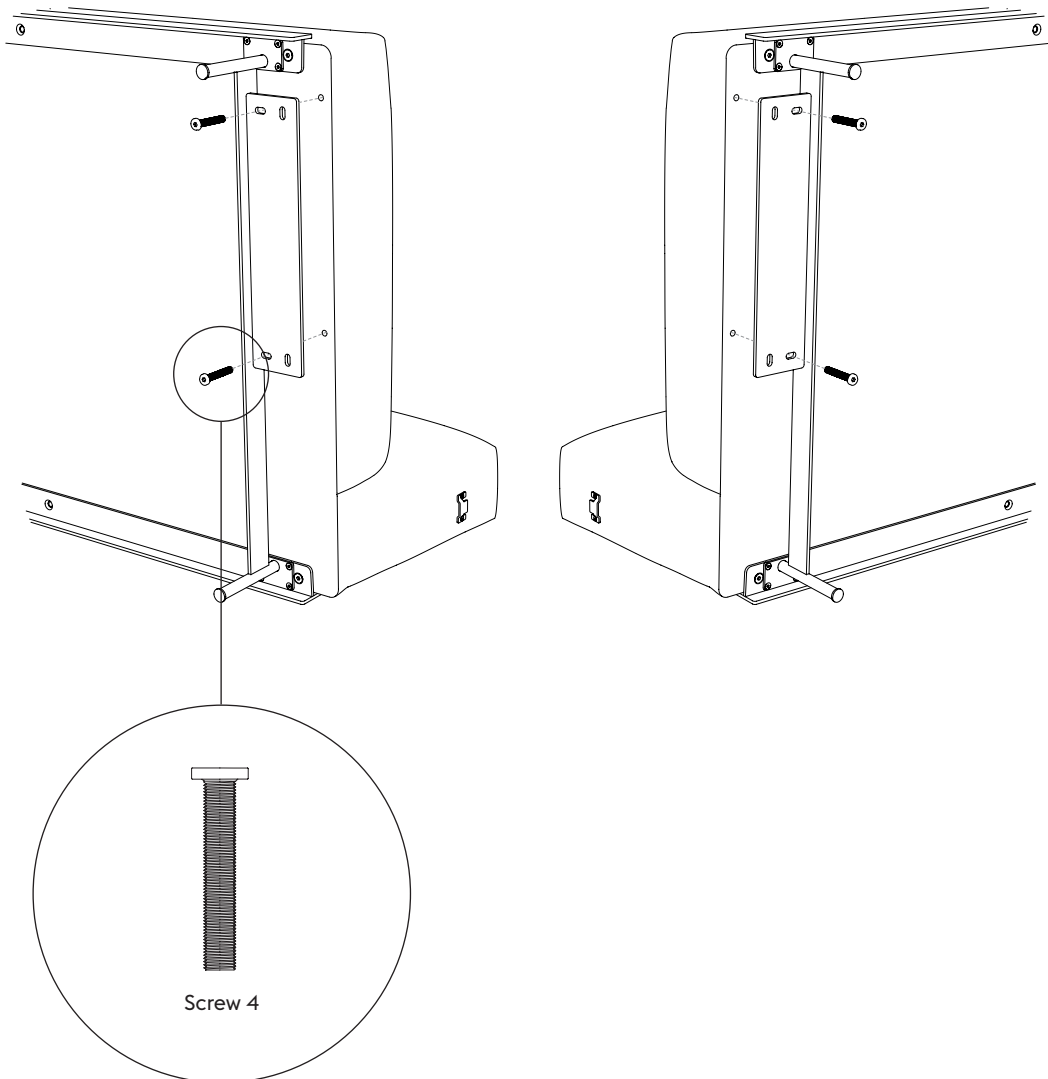

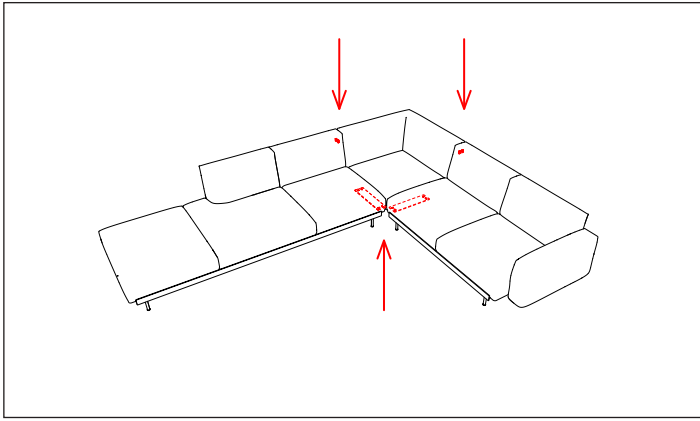

Then, link the upper brackets as shown, and secure the lower linking brackets with the remaining screws underneath.

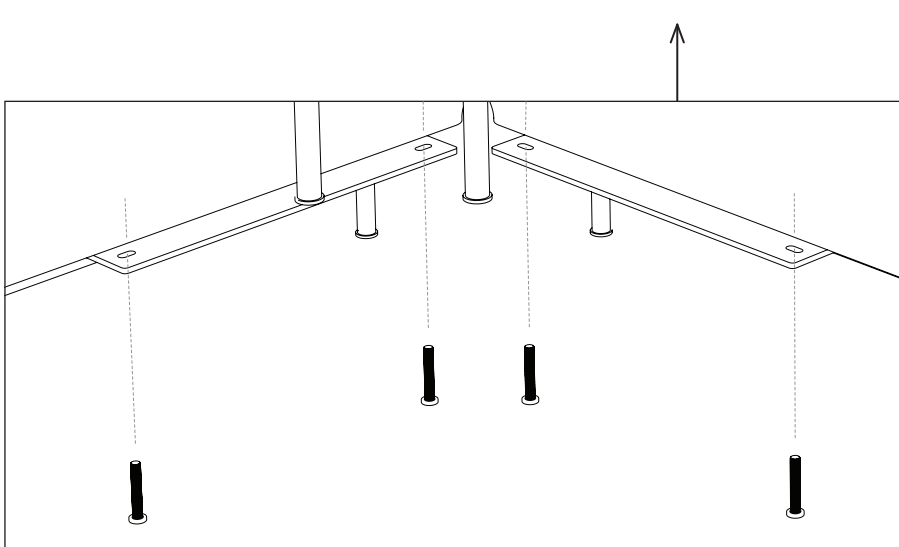
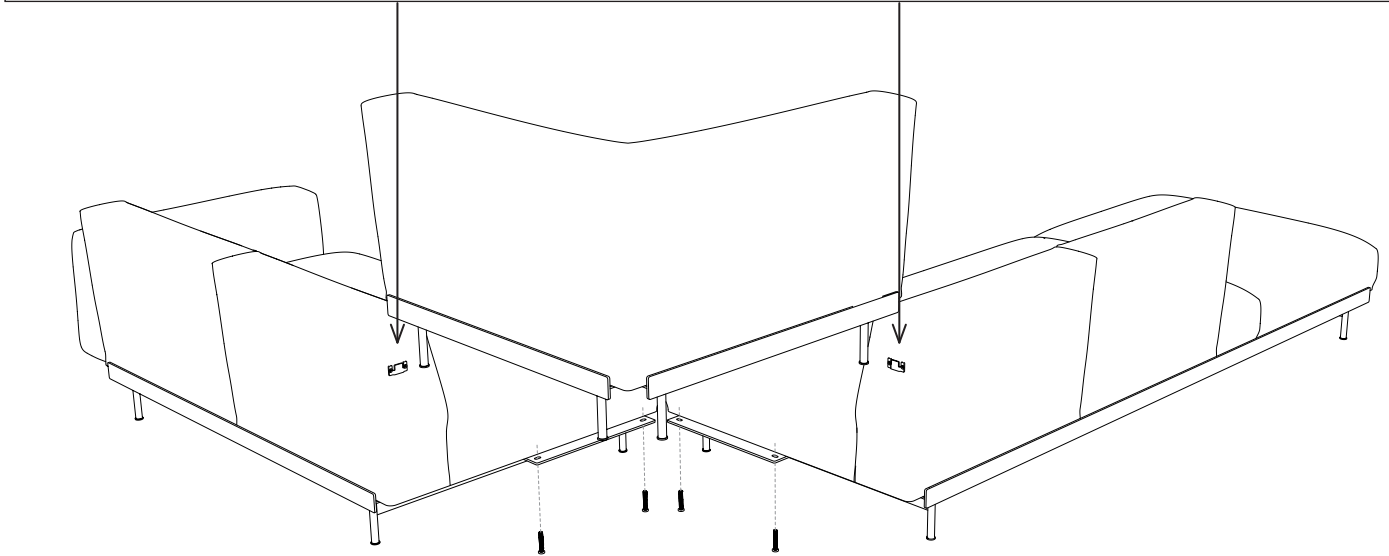
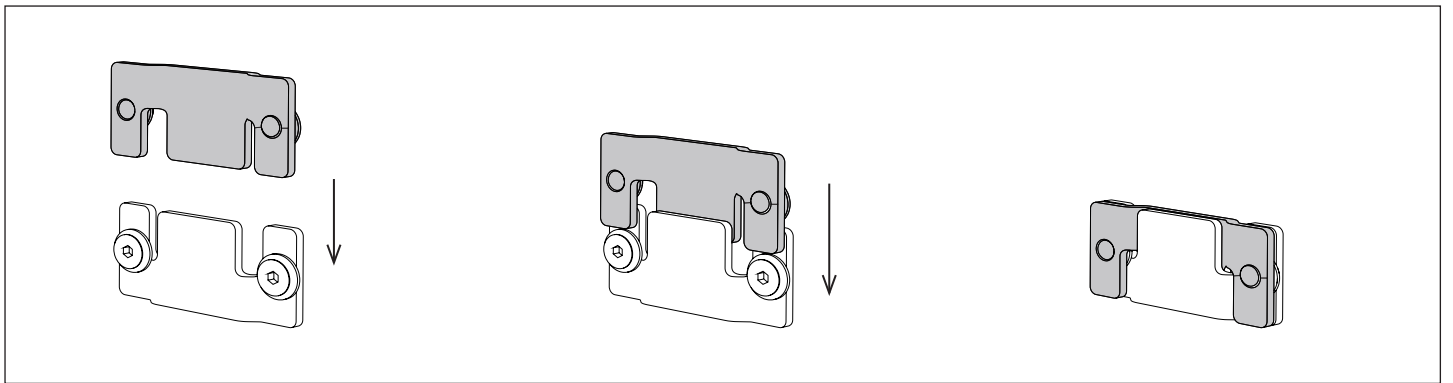

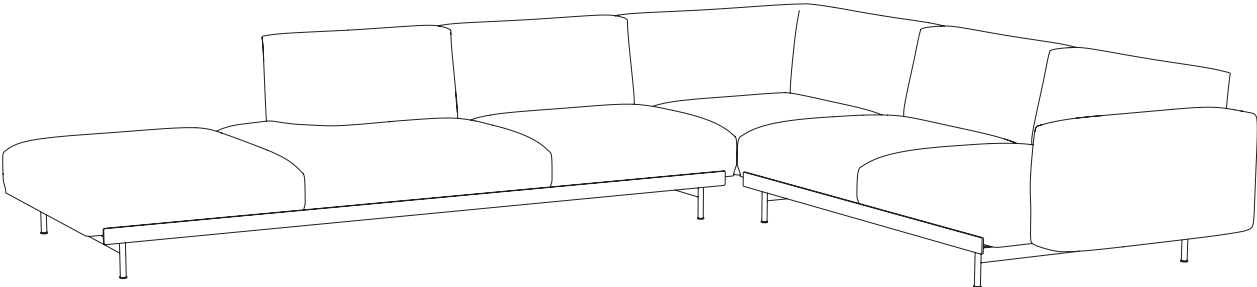

CLEANING — RENGØRING — SÄUBERN — NETTOYAGE — LIMPIEZA

- EN To remove stains from a textile-upholstered sofa, use foam from a mild mixture of water and detergent. A leather-upholstered sofa should be treated 2-3 times a year. Keep leather products away from direct sunlight and dry air.
- DK Brug skummet fra en mild blanding af vand og opvaskemiddel til at fjerne pletter på en tekstil polstret sofa. Sofaer med læder polster skal behandles 2-3 gange om året. Hold læder produkter fra direkte sollys og tør luft.
- DE Zum Entfernen von Flecken auf gepolsterten Sofas verwenden Sie den Schaum aus einer Wasser-Spülmittel-Mischung. Sofas mit Lederpolstern sollten 2-3 Mal im Jahr behandelt werden. Die Lederprodukte von direkter Sonneneinstrahlung und trockener Luft fernhalten.
- FR Pour retirer les tâches du textile sur les canapés, utilisez de la mousse depuis un mélange d'eau douce et du détergent. Le cuir des canapés devrait être traité 2 à 3 fois par an. Veillez à ne pas exposer directement les produits en cuir à la lumière et à l'air frais.
- ES Para eliminar las manchas del tapizado textil de los sofás, utilice una solución de agua jabonosa neutra. Trate el tapizado de los sofás de cuero entre 2 y 3 veces al año con el set de cuidado para pieles incluido. No exponga los productos de cuero a la luz solar directa ni al aire seco.