

LINEAR SYSTEM SERIES—ORDER GUIDE

The Linear System Series brings a new perspective to the evolving needs of the modern workspaces, hospitality settings and educational institutions through its configurable design across tables, lighting, screens and trays alongside its custom integrated power solution, allowing one to tailor the design to the exact needs of any space.

Option A — Choose between one of our predesigned table configurations and simply add your desired lamps and accessories.

Option B — Create your own configuration from scratch and add lamps and accessories from there.

Option A — Predesigned Table Configurations

STEP 1. TABLES

Select either the Linear System Table or one of two Linear System Table Configurations.

Note
Different finishes of tabletops cannot be mixed as they might vary in thickness.

Table
No of Persons — 4-6

Configuration 1
No of Persons — 6-8

Configuration 2
No of Persons — 8-12

Linear System Table W142

Height — 74 cm / 29.1"
Table top width — 142 cm / 55.9"
Total width — 146.9 cm / 57.8"

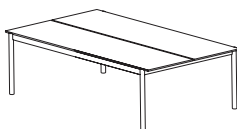

L 240 cm / 94.5"

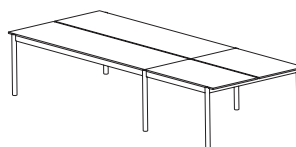

L 360 cm / 141.7"

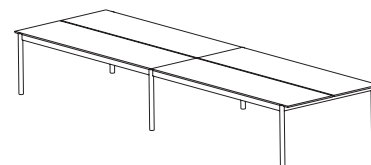

L 480 cm / 189"

Linear System Table W110

Height — 74 cm / 29.1"
Table top width — 110 cm / 43.3"
Total width — 115 cm / 45.3"

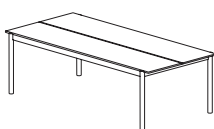

L 240 cm / 94.5"

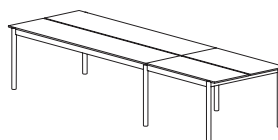

L 360 cm / 141.7"

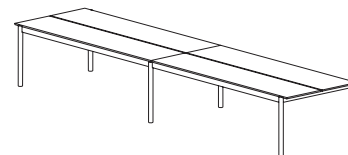

L 480 cm / 189"

Linear System Table High H95

Height — 95 cm / 37.4"
Table top width — 110 cm / 43.3"
Total width — 115 cm / 45.3"

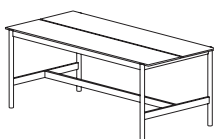

L 240 cm / 94.5"

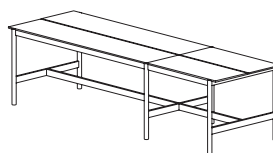

L 360 cm / 141.7"

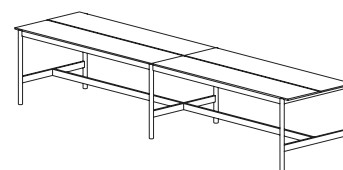

L 480 cm / 189"

Linear System Table High H105

Height — 105 cm / 41.4"
Table top width — 110 cm / 43.3"
Total width — 115 cm / 45.3"

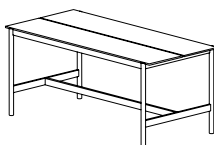

L 240 cm / 94.5"

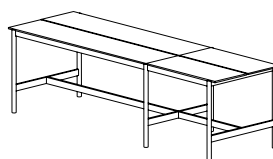

L 360 cm / 141.7"

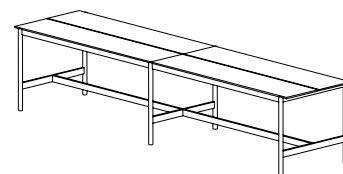

L 480 cm / 189"

OPTION A

1. TABLES / 2. ACCESSORIES / 3. LIGHTING / 4. TABLE POWER OUTLET / 5. INTEGRATED POWER / 6. CABLE TRAY / 7. CABLE GUIDE

LINEAR SYSTEM SERIES—ORDER GUIDE

STEP 2. ACCESSORIES

Trays

Add your desired number of Linear System Trays.

Note
Trays must be mounted at least 5 cm / 2" from the table edge.

Linear System Tray — Ø24 cm / 9.5"

Height — 15,6 cm / 6.2"
Diameter — 24 cm / 9.5"



Linear System Tray — Ø36 cm / 14.2"

Height — 9,6 cm / 3.8"
Diameter — 36 cm / 14.2"



Linear System Tray — 75 cm / 29.5"

Height — 15 cm / 5.9"
Width — 21 cm / 8.3"
Length — 75 cm / 29.5"

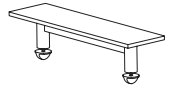

Screens

Add your desired number of Linear System Screens.

Note
We recommend that screens are mounted to the table. They must be placed at least 5 cm / 2" from the table edge.

Linear System Screen — 75 cm / 29.5"

Height — 35 cm / 13.8"
Width — 15 cm / 5.9"
Length — 75 cm / 29.5"

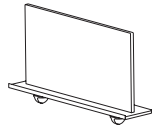

Linear System Screen — 125 cm / 49.2"

Height — 35 cm / 13.8"
Width — 15 cm / 5.9"
Length — 125 cm / 49.2"

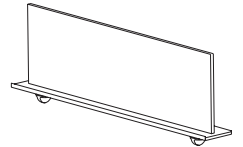

Linear System Screen — 178 cm / 70.1"

Height — 35 cm / 13.8"
Width — 15 cm / 5.9"
Length — 178 cm / 70.1"

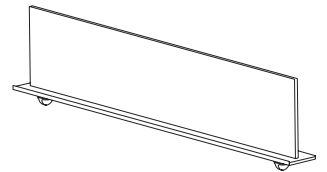

Note
Please note that only the Linear System Screen 125 cm / 49.2" can be mounted across the table.

Example

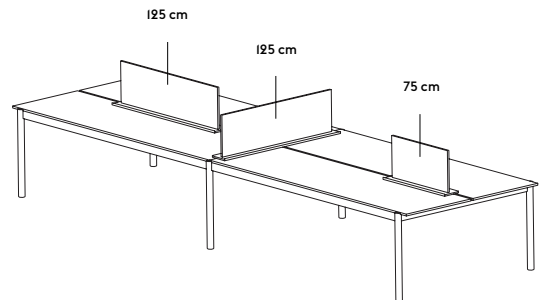

OPTION A

1. TABLES / 2. ACCESSORIES / 3. LIGHTING / 4. TABLE POWER OUTLET / 5. INTEGRATED POWER / 6. CABLE TRAY / 7. CABLE GUIDE

PRICE LIST
FOR MORE INFORMATION, VISIT MUUTO.COM

MUUTO

LINEAR SYSTEM SERIES—ORDER GUIDE

STEP 3. LIGHTING

Add your desired number of Linear Lamps.

Note

The Linear Table Lamp has one USB-C plug.

Linear Table Lamp

Height — 36,5 cm / 14.4"
Width — 23,2 cm / 9.1"
Depth — 16,5 cm / 6.5"



Note

Linear Mounted Lamp must be mounted at least 5 cm / 2" from the table edge.

Please be aware that the Linear Mounted Lamp and Table Power Outlet, both designed for the Linear System Series, have a special power solution with special plugs. See more on page 4

Linear Mounted Lamp — 23,2 cm / 9.1"

Height — 36,5 cm / 14.4"
Width — 23,2 cm / 9.1"
Depth — 10,7 cm / 4.2"

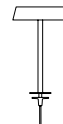

Linear Mounted Lamp — 209,2 cm / 82.4"

Height — 70,7 cm / 27.8"
Width — 209,2 cm / 82.4"
Depth — 10,7 cm / 4.2"



Linear Pendant Lamp — 87,2 cm / 34.3"

Height — 5,4 cm / 2.1"
Width — 87,2 cm / 34.3"
Depth — 10,7 cm / 4.2"



Linear Pendant Lamp — 169,2 cm / 66.6"

Height — 5,4 cm / 2.1"
Width — 169,2 cm / 66.6"
Depth — 10,7 cm / 4.2"



STEP 4. TABLE POWER OUTLETS

Specify your desired number of Table Power Outlets. Each Table Power Outlet has two outlets (one at each end) and one USB-A and USB-C plug to which standard plugs can be connected. Kindly remember to select your region-specific version.

Note

Linear System Table Power Outlet must be mounted at least 5 cm / 2" from the table edge.

Linear System Table Power Outlet — EU, UK

Height — 7 cm / 2.8"
Width — 7 cm / 2.8"
Length — 18 cm / 7.1"

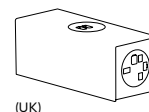
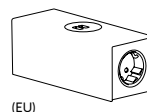

OPTION A

1. TABLES / 2. ACCESSORIES / 3. LIGHTING / 4. TABLE POWER OUTLET / 5. INTEGRATED POWER / 6. CABLE TRAY / 7. CABLE GUIDE

LINEAR SYSTEM SERIES—ORDER GUIDE

STEP 5. INTEGRATED POWER FOR MOUNTED LAMPS & TABLE POWER OUTLETS

If you'd like to add the Mounted Lamp(s) or Table Power Outlet(s), select the Table Power Kit for the Linear System Table or one of the three Power Configurations that match your selected Linear System Table Configuration. Kindly remember to select the region-specific power kit.

Note
Each Distribution Block has five outlets to which up to five Linear Mounted Lamps or Linear System Table Power Outlets can be plugged in.

The Extension Kit must be connected to the Power Kit. An Extension Kit has no standard plug.

Distribution Block — 5-way

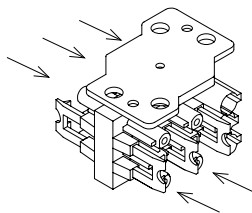

EU cable
200 cm cable

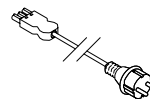

UK cable
200 cm fused plug

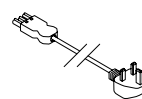

Linear System Table

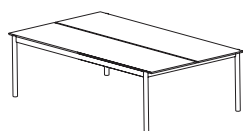

Linear System Power

Power Kit (1 pcs)
200 cm / 59" cable (EU or UK)
Distribution Block

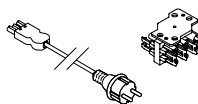

Linear System Table Configuration 1

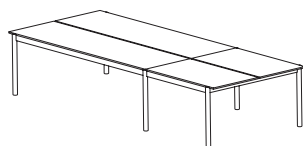

Linear System Power Configuration 1

Power Kit (1 pcs)
200 cm / 59" cable (EU or UK)
Distribution Block

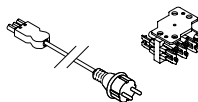

Power Extension Kit — 200 cm (1 pcs)
200 cm / 79" cable
Distribution Block

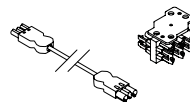

+

Linear System Table Configuration 2

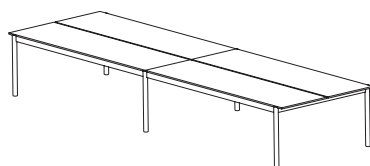

Linear System Power Configuration 2

Power Kit (1 pcs)
200 cm / 59" cable (EU or UK)
Distribution Block

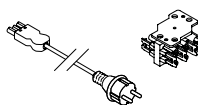

Power Extension Kit — 250 cm (1 pcs)
250 cm / 98" cable
Distribution Block

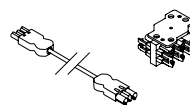

+

OPTION A

1. TABLES / 2. ACCESSORIES / 3. LIGHTING / 4. TABLE POWER OUTLET / 5. INTEGRATED POWER / 6. CABLE TRAY / 7. CABLE GUIDE

PRICE LIST
FOR MORE INFORMATION, VISIT MUUTO.COM

MUUTO

LINEAR SYSTEM SERIES—ORDER GUIDE

Note

The Integrated Power for Linear System Series has unique internal plugs to provide a slim and discreet look. This means that you cannot connect a standard plug to the power without using the Linear Table Power Outlet or changing the standard plug to a matching plug, being the Wieland GST1813 plug.

The Linear Mounted Lamps must be connected to the integrated Power Kit.

Wieland GST1813 plug

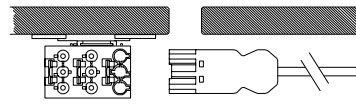

Standard plug (EU or UK)

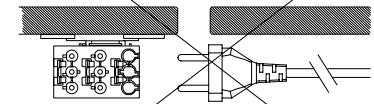

1. Connecting using the Wieland GST1813 plug

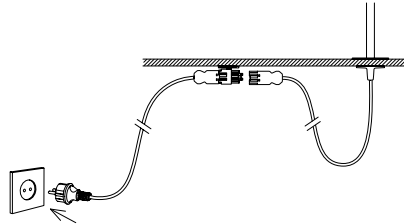

2. Connecting using a standard plug to the Linear Table Power Outlet

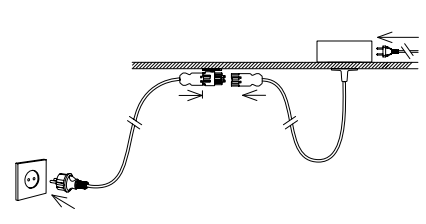

LINEAR TABLE LAMP ONLY

The Linear Table Lamp can either be connected to a standard wall plug or the Table Power Outlet.

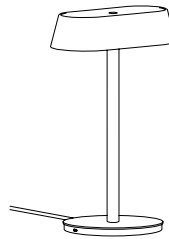

Standard plug

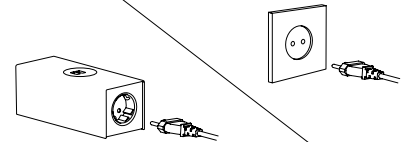

Linear Table Power Outlet

Alternatively, you can connect it to the integrated Power Kit by replacing the plug with a custom Wieland GST1813 plug that is included with the lamp. Kindly refer to the Linear Table Lamp manual for instructions.

Integrated Power Kit (Wieland GST1813 plug)

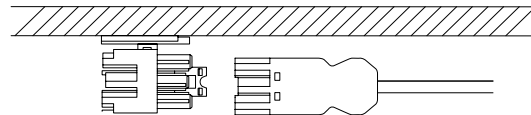

OPTION A

1. TABLES / 2. ACCESSORIES / 3. LIGHTING / 4. TABLE POWER OUTLET / 5. INTEGRATED POWER / 6. CABLE TRAY / 7. CABLE GUIDE

LINEAR SYSTEM SERIES—ORDER GUIDE

STEP 6. CABLE TRAYS

We recommend using 1 Cable Tray for the End Module – 120 cm / 47.2" and up to 3 Cable Trays for the Linear Table, End Module – 240 cm / 94.2" and the Middle Module – 240 cm / 94.2".

Linear System Cable Tray

Height – 3 cm / 1.2"
Width – 22 cm / 8.7"
Depth – 60 cm / 23.7"

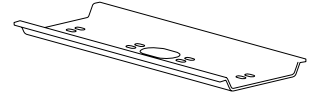

Example:

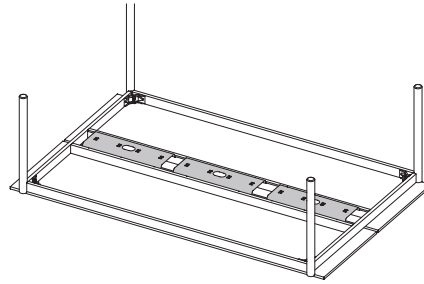

Linear System Table – 240 cm / 94.5"

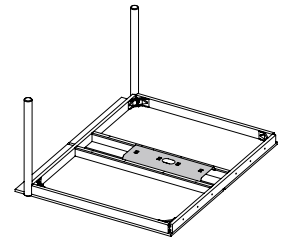

Linear System End Module – 120 cm / 47.2"

STEP 7. CABLE GUIDE

Cable guide also works for Base Table and fits a US cable.

Cable Guide

Height – 73 cm / 28.7"
Height – 95 cm / 37.4"
Height – 105 cm / 41.3"

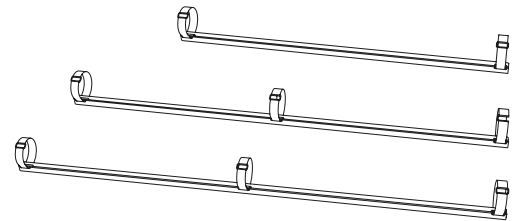

Example:

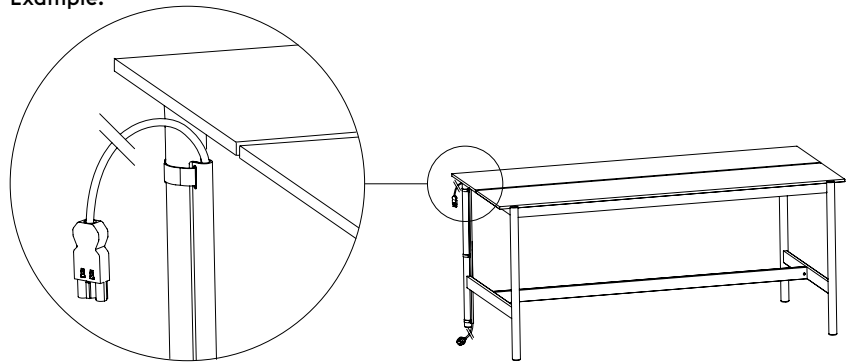

OPTION A

1. TABLES / 2. ACCESSORIES / 3. LIGHTING / 4. TABLE POWER OUTLET / 5. INTEGRATED POWER / 6. CABLE TRAY / 7. CABLE GUIDE

LINEAR SYSTEM SERIES—ORDER GUIDE

Option B — Create your own configuration

STEP 1. TABLES

A)

A configuration must always have End Modules in each end.

Start by defining the total length of your desired configuration, then select two table ends.

Note

Different finishes of tabletops cannot be mixed as they might vary in thickness.

Linear System End Module — 240 cm / 94.5"

Height — 74 cm / 29.1";
Width — 146,9 cm / 57.8"
Length — 240 cm / 94.5"
No of Persons — 4-6



Height — 74 cm / 29.1";
Width — 110 cm / 43.3";
Length — 240 cm / 94.5"
No of Persons — 4-6



Height - 95 cm / 37.4"
Width - 110 cm / 43.3"
Length - 240 cm / 94.5"
No of Persons - 4-6

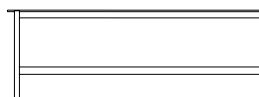

Height - 105 cm / 41.4"
Width - 110 cm / 43.3"
Length - 240 cm / 94.5"
No of Persons - 4-6

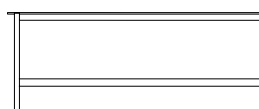

Linear System End Module — 120 cm / 47.2"

Height - 74 cm / 29.1"
Width - 110 cm / 43.3"
Length - 120 cm / 47.2"
No of Persons - 2

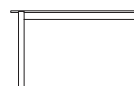

Height - 74 cm / 29.1"
Width - 146,9 cm / 57.8"
Length - 120 cm / 47.2"
No of Persons - 2



Height - 95 cm / 37.4"
Width - 110 cm / 43.3"
Length - 120 cm / 47.2"
No of Persons - 2

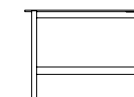

Height - 105 cm / 41.4"
Width - 110 cm / 43.3"
Length - 120 cm / 47.2"
No of Persons - 2

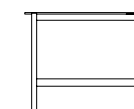

B)

Next, add the second, and final, End Module or your desired number of Middle Modules, only available in 240 cm / 94.5" length but in 2 different widths (110 cm / 43.3" and 142 cm / 55.9").

Note

Please note that it is not possible to connect more than two End Modules.

Linear System Middle Module — 240 cm / 94.5"

Width — 110 cm / 43.3";
142 cm / 55.9"
Length — 240 cm / 94.5"
No of Persons — 4-6



C)

Next, you must order 1 set of Connecting Legs every time two modules are connected.

Note

95cm / 37.4" and 105cm / 41.4" Connecting Legs can only be connected to 110cm / 43.3" width tabletops (not to 142 cm/55.9" width tabletops).

Linear System Connecting Legs

Height — 74 cm / 29.1"
95 cm / 37.4"
105 cm / 41.4"

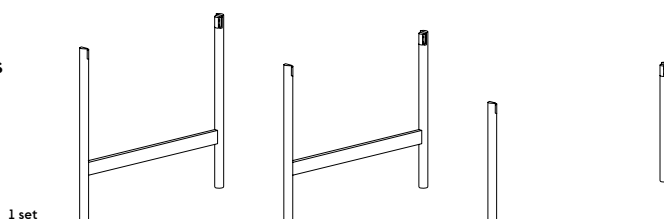

If you'd like a configuration of one End Module — 240 cm / 94.5" and one Middle Module — 240 cm / 94.5" and one End Module — 240 cm / 94.5", you must order two sets of Connecting Legs, as shown in the illustration.

Example

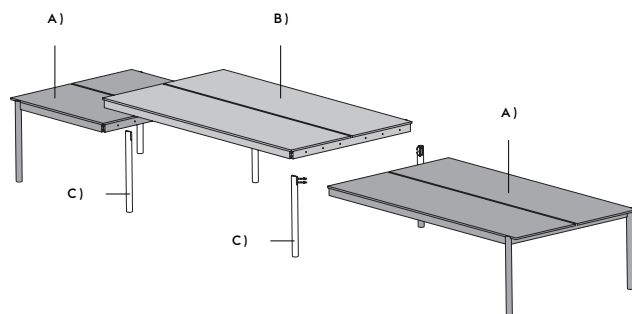

OPTION B

1. TABLES / 2. ACCESSORIES / 3. LIGHTING / 4. TABLE POWER OUTLET / 5. INTEGRATED POWER / 6. CABLE TRAY / 7. CABLE GUIDE

LINEAR SYSTEM SERIES—ORDER GUIDE

STEP 2. ACCESSORIES

Trays

Add your desired number of Linear System Trays.

Note
Trays must be mounted at least 5 cm / 2" from the table edge.

Linear System Tray — Ø24 cm / 9.5"

Height — 15,6 cm / 6.2"
Diameter — 24 cm / 9.5"



Linear System Tray — Ø36 cm / 14.2"

Height — 9,6 cm / 3.8"
Diameter — 36 cm / 14.2"



Linear System Tray — 75 cm / 29.5"

Height — 15 cm / 5.9"
Width — 21 cm / 8.3"
Length — 75 cm / 29.5"

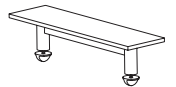

Screens

Add your desired number of Linear System Screens.

Note
We recommend that screens are mounted to the table. They must be placed at least 5 cm / 2" from the table edge.

Linear System Screen — 75 cm / 29.5"

Height — 35 cm / 13.8"
Width — 15 cm / 5.9"
Length — 75 cm / 29.5"

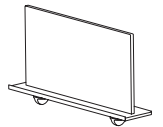

Linear System Screen — 125 cm / 49.2"

Height — 35 cm / 13.8"
Width — 15 cm / 5.9"
Length — 125 cm / 49.2"

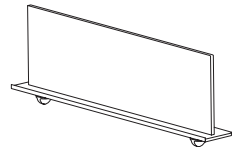

Linear System Screen — 178 cm / 70.1"

Height — 35 cm / 13.8"
Width — 15 cm / 5.9"
Length — 178 cm / 70.1"

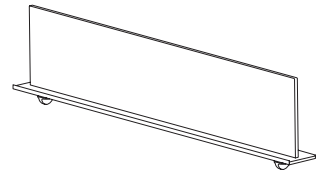

Note
Please note that only the Linear System Screen 125 cm / 49.2" can be mounted across the table.

Example

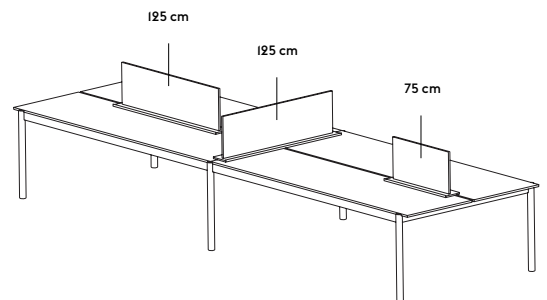

OPTION B

1. TABLES / 2. ACCESSORIES / 3. LIGHTING / 4. TABLE POWER OUTLET / 5. INTEGRATED POWER / 6. CABLE TRAY / 7. CABLE GUIDE

PRICE LIST
FOR MORE INFORMATION, VISIT MUUTO.COM

MUUTO

LINEAR SYSTEM SERIES—ORDER GUIDE

STEP 3. LIGHTING

Add your desired number of Linear Lamps.

Note
The Linear Table Lamp has one USB-C plug.

Linear Table Lamp

Height — 36,5 cm / 14.4"
Width — 23,2 cm / 9.1"
Depth — 16,5 cm / 6.5"



Note
Linear Mounted Lamp must be mounted at least 5 cm / 2" from the table edge.

Please be aware that the Linear Mounted Lamp and Table Power Outlet, both designed for the Linear System Series, have a special power solution with special plugs. See more on page 4.

Linear Mounted Lamp — 23,2 cm / 9.1"

Height — 36,5 cm / 14.4"
Width — 23,2 cm / 9.1"
Depth — 10,7 cm / 4.2"

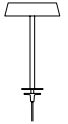

Linear Mounted Lamp — 209,2 cm / 82.4"

Height — 70,7 cm / 27.8"
Width — 209,2 cm / 82.4"
Depth — 10,7 cm / 4.2"



Linear Pendant Lamp — 87,2 cm / 34.3"

Height — 5,4 cm / 2.1"
Width — 87,2 cm / 34.3"
Depth — 10,7 cm / 4.2"



Linear Pendant Lamp — 169,2 cm / 66.6"

Height — 5,4 cm / 2.1"
Width — 169,2 cm / 66.6"
Depth — 10,7 cm / 4.2"



STEP 4. TABLE POWER OUTLETS

Specify your desired number of Table Power Outlets. Each Table Power Outlet has two outlets (one at each end) and one USB-A and USB-C plug to which standard plugs can be connected. Kindly remember to select your region-specific version.

Note
Linear System Table Power Outlet must be mounted at least 5 cm / 2" from the table edge.

Linear System Table Power Outlet — EU, UK

Height — 7 cm / 2.8"
Width — 7 cm / 2.8"
Length — 18 cm / 7.1"

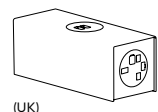
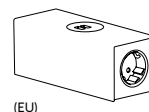

OPTION B

1. TABLES / 2. ACCESSORIES / 3. LIGHTING / 4. TABLE POWER OUTLET / 5. INTEGRATED POWER / 6. CABLE TRAY / 7. CABLE GUIDE

PRICE LIST
FOR MORE INFORMATION, VISIT MUUTO.COM

MUUTO

LINEAR SYSTEM SERIES—ORDER GUIDE

STEP 5. INTEGRATED POWER FOR MOUNTED LAMPS & TABLE POWER OUTLET

If you'd like to add the Mounted Lamp(s) and/or Table Power Outlet(s), select the Power Kit for the first End Module you choose and then add an a Power Extension Kit for each table added.

If you add a End Module or a Middle Module — 240 cm / 94.5", select the 250 cm / 98" Power Extension Kit.

If you add a End Module — 120 cm / 47.2", select the 200 cm / 79" Power Extension kit.

Power Kit (1 pcs)

200 cm / 59" cable (EU or UK)
Distribution Block

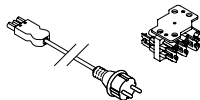

Power Extension Kit (X pcs)

200 cm / 79" or 250 cm / 98" cable
Distribution Block

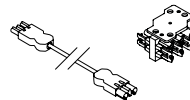

Example 1

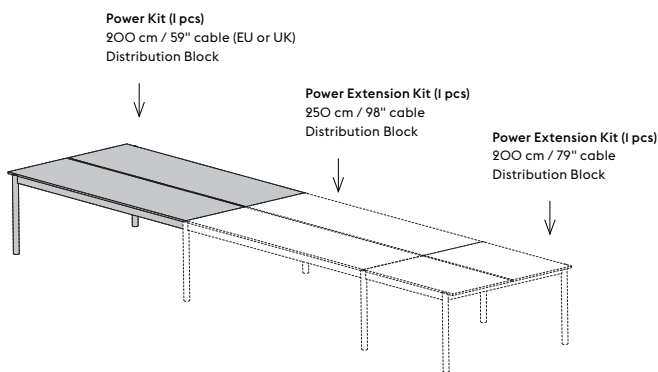

Example 2

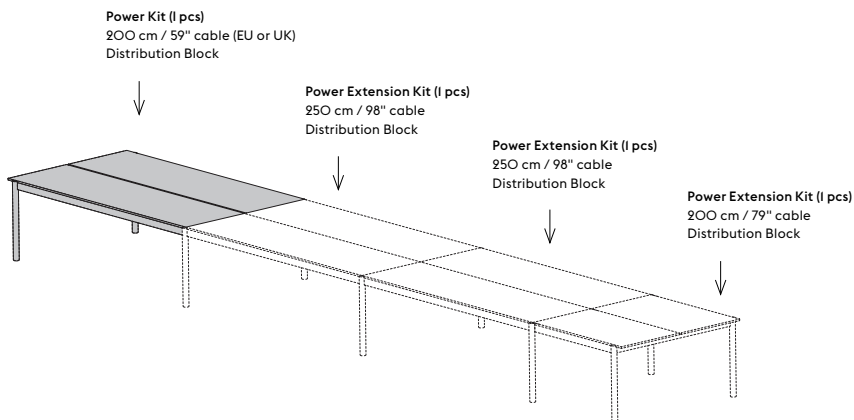

LINEAR TABLE LAMP ONLY

The Linear Table Lamp can either be connected to a standard wall plug or the Table Power Outlet.

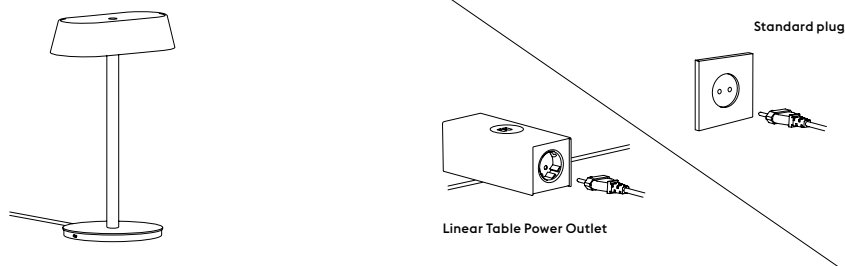

Alternatively, you can connect it to the integrated Table Power Kit by replacing the plug with a custom Wieland GST1813 plug that is included with the lamp. Kindly refer to the Linear Table Lamp manual for instructions.

Integrated Table Power Kit (Wieland GST1813 plug)

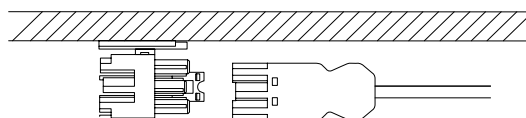

OPTION B

1. TABLES / 2. ACCESSORIES / 3. LIGHTING / 4. TABLE POWER OUTLET / 5. INTEGRATED POWER / 6. CABLE TRAY / 7. CABLE GUIDE

LINEAR SYSTEM SERIES—ORDER GUIDE

STEP 6. CABLE TRAYS

We recommend using 1 Cable Tray for the End Module – 120 cm / 47.2" and up to 3 Cable Trays for the Linear Table, End Module – 240 cm / 94.2" and the Middle Module – 240 cm / 94.2".

Linear System Cable Tray

Height – 3 cm / 1.2"
Width – 22 cm / 8.7"
Depth – 60 cm / 23.7"

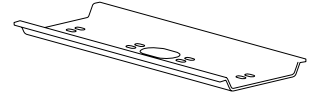

Example:

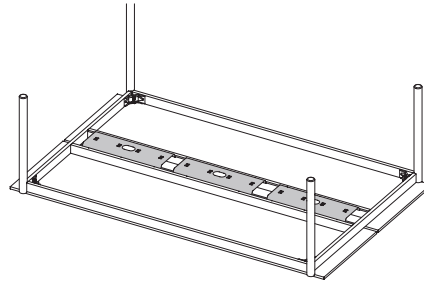

Linear System Table – 240 cm / 94.5"

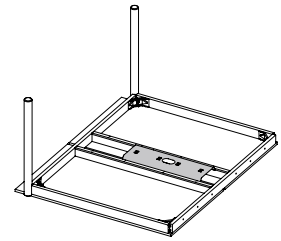

Linear System End Module – 120 cm / 47.2"

STEP 7. CABLE GUIDE

Cable guide also works for Base Table and fits a US cable.

Cable Guide

Height – 73 cm / 28.7"
Height – 95 cm / 37.4"
Height – 105 cm / 41.3"

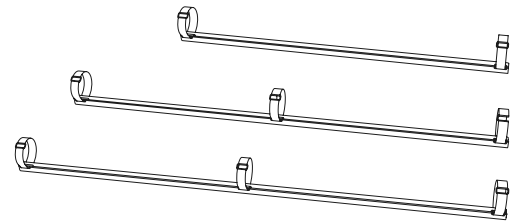

Example:

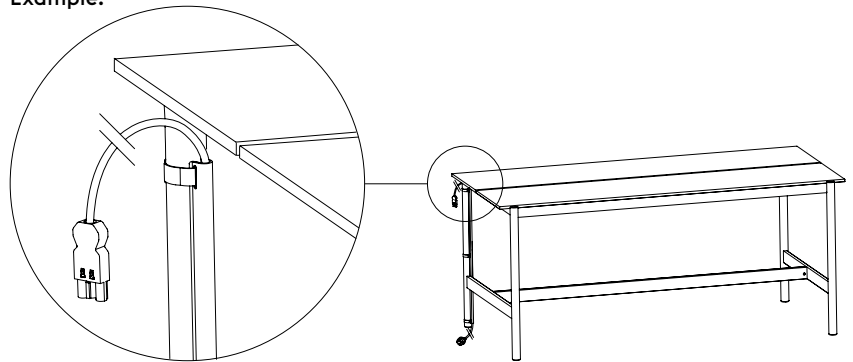

OPTION B

1. TABLES / 2. ACCESSORIES / 3. LIGHTING / 4. TABLE POWER OUTLET / 5. INTEGRATED POWER / 6. CABLE TRAY / 7. CABLE GUIDE

